



US00D931844S

(12) **United States Design Patent**  
**Kim et al.**

(10) **Patent No.:** **US D931,844 S**  
(45) **Date of Patent:** **\*\* Sep. 28, 2021**

(54) **CASE FOR ELECTRONIC COMMUNICATIONS DEVICE**

D650,371 S 12/2011 Wibby  
D654,491 S 2/2012 Melanson  
D655,281 S 3/2012 Turocy

(Continued)

(71) Applicant: **SPIGEN KOREA CO., LTD.**, Seoul (KR)

(72) Inventors: **Tae Heon Kim**, Seoul (KR); **Jae Hong Cho**, Seoul (KR)

(73) Assignee: **SPIGEN KOREA CO., LTD.**, Seoul (KR)

(\*\*) Term: **15 Years**

(21) Appl. No.: **29/700,603**

(22) Filed: **Aug. 2, 2019**

(51) **LOC (13) Cl.** ..... **14-03**

(52) **U.S. Cl.**  
USPC ..... **D14/250**

(58) **Field of Classification Search**  
USPC ..... D3/201, 218, 226, 227, 247, 249, 250, D3/269, 303; D13/103, 107, 108, 119; D14/137, 138 R, 138 AA, 138 C, 138 G, D14/172, 192, 203.3–203.7, 217, 238.1, D14/247, 248, 250–253, 434, 440, 447, D14/496

CPC ..... H04B 1/3888; H04M 1/0283; H04M 1/0202; A45C 1/06; A45C 2011/002; A45C 11/00; A45F 2005/028; A45F 2200/0525

See application file for complete search history.

(56) **References Cited**

**U.S. PATENT DOCUMENTS**

- 586,211 A \* 7/1897 Basquin ..... E06B 9/24 359/592
- D619,361 S 7/2010 Andre et al.
- D643,029 S 8/2011 Feng
- 7,989,085 B2 \* 8/2011 Li ..... H04M 1/0283 174/50
- D646,265 S 10/2011 Fathollahi

**OTHER PUBLICATIONS**

SUPCASE Unicorn Beetle Pro Series Case for iPhone, earliest photo review date Sep. 21, 2016, [online][site visited Jan. 23, 2020] URL: <https://www.amazon.com/SUPCASE-Unicorn-Full-body-Holster-Protector/dp/B01KK86QW2> (Year: 2016).\*

(Continued)

*Primary Examiner* — L. A. Grabenstetter

(74) *Attorney, Agent, or Firm* — Heedong Chae; Lucem, PC

(57) **CLAIM**

The ornamental design for a case for electronic communications device, as shown and described.

**DESCRIPTION**

FIG. 1 is a front perspective view of the case for electronic communications device showing our new design; FIG. 2 is a rear perspective view thereof; FIG. 3 is a front elevational view thereof; FIG. 4 is a rear elevational view thereof; FIG. 5 is a left side elevational view thereof; FIG. 6 is a right side elevational view thereof; FIG. 7 is a top plan view thereof; FIG. 8 is a bottom plan view thereof; and, FIG. 9 is an enlarged detail view of the encircled portion of FIG. 2.

The dot-dash broken line circles in FIGS. 2 and 9 are included for illustrating the portion of the case for electronic communications device shown in an enlarged scale in FIG. 9. The dot-dash broken line forms no part of the claimed design.

**1 Claim, 9 Drawing Sheets**

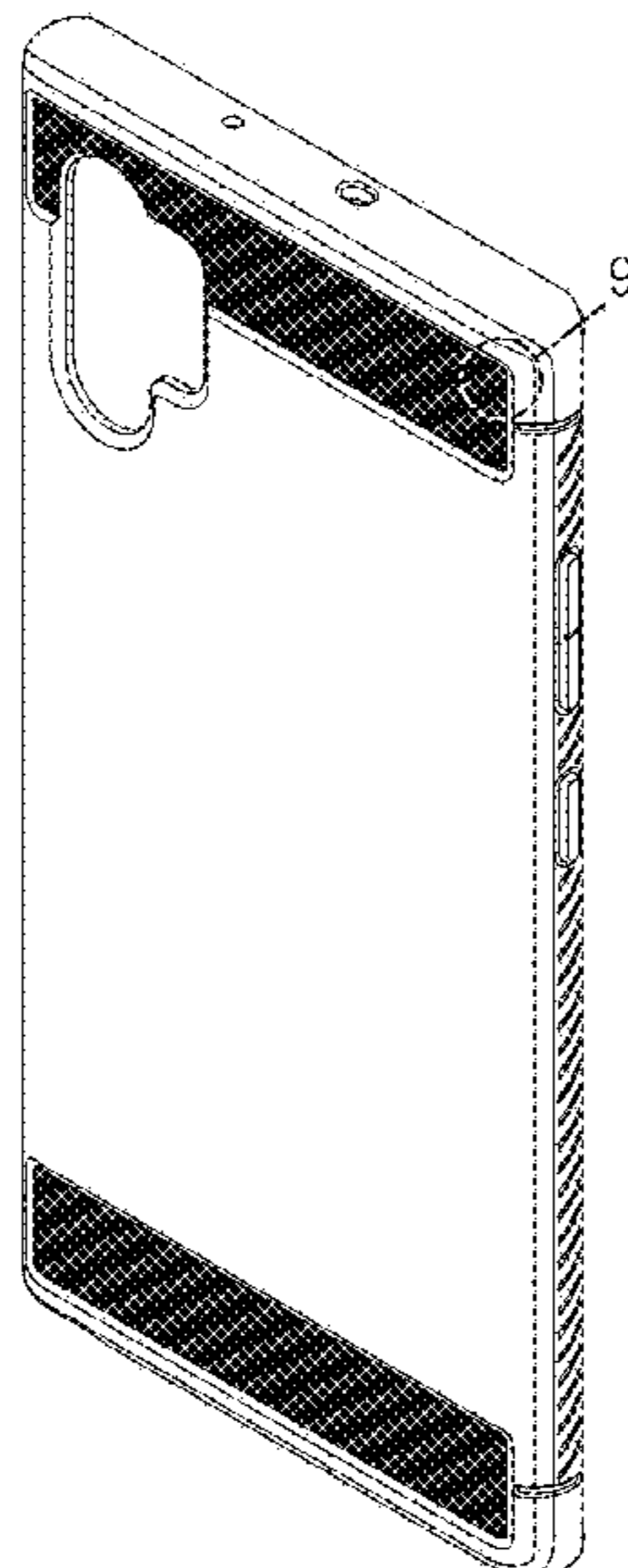

(56)

References Cited

U.S. PATENT DOCUMENTS

D664,133 S 7/2012 Zheng  
 D668,646 S 10/2012 Li  
 D673,547 S 1/2013 Melanson  
 D676,844 S 2/2013 Weller  
 D677,249 S 3/2013 Li  
 D678,907 S 3/2013 Lee  
 D679,271 S 4/2013 Liu  
 D679,692 S 4/2013 Fahrenдорff et al.  
 D681,615 S 5/2013 Fathollahi  
 D681,617 S 5/2013 Weller et al.  
 D683,340 S 5/2013 Chang et al.  
 D684,568 S 6/2013 Fitzgerald  
 D685,776 S 7/2013 Bau  
 D691,122 S 10/2013 Bau  
 D697,905 S 1/2014 Chang  
 D698,767 S 2/2014 Son  
 D700,172 S 2/2014 Li  
 D700,174 S \* 2/2014 Li ..... D14/248  
 D706,254 S 6/2014 Chang  
 D714,273 S 9/2014 Kim et al.  
 D716,281 S 10/2014 Melanson et al.  
 D716,282 S 10/2014 Melanson et al.  
 D717,774 S 11/2014 Fathollahi  
 D720,759 S 1/2015 Deng et al.  
 D721,070 S 1/2015 Pickett  
 D727,883 S 4/2015 Brand  
 D727,886 S 4/2015 Bertrand et al.  
 D731,472 S 6/2015 Lee  
 D731,481 S 6/2015 Akana et al.  
 D732,012 S 6/2015 Tsai  
 D733,693 S 7/2015 Wang et al.  
 D739,391 S 9/2015 Chen et al.  
 D741,845 S 10/2015 Kim  
 D746,273 S 12/2015 Herbst  
 D746,274 S 12/2015 Herbst  
 9,223,346 B2 12/2015 Wilson  
 D748,614 S 2/2016 Ju  
 D749,068 S 2/2016 Zaborski et al.  
 D749,535 S 2/2016 Joung et al.  
 D749,555 S 2/2016 Poon et al.  
 D749,557 S 2/2016 Feng  
 D751,058 S 3/2016 Cocchia  
 9,288,295 B2 3/2016 Ivanovski  
 D756,343 S 5/2016 Wall  
 D756,909 S 5/2016 Gupta  
 D756,910 S 5/2016 Gupta  
 D756,911 S 5/2016 Gupta  
 D757,699 S 5/2016 Lee  
 D761,239 S 7/2016 Kim  
 D762,205 S 7/2016 Dang  
 D763,241 S 8/2016 Kim  
 D763,242 S 8/2016 Kim  
 D763,837 S 8/2016 Choe et al.  
 D763,842 S 8/2016 Chang et al.  
 D765,627 S 9/2016 Watt  
 D765,635 S 9/2016 Chang et al.  
 D765,638 S 9/2016 Gaylord et al.  
 D765,640 S 9/2016 Bulkley et al.  
 D765,641 S 9/2016 Bulkley et al.  
 D765,642 S 9/2016 Bulkley  
 D765,645 S 9/2016 Kim  
 D767,485 S 9/2016 To et al.  
 D767,554 S 9/2016 Bertrand et al.  
 D770,188 S \* 11/2016 Fang ..... D5/53  
 D771,611 S 11/2016 Chang et al.  
 D772,854 S 11/2016 Igarashi  
 9,480,319 B2 11/2016 Dining et al.  
 D774,498 S 12/2016 Tao  
 D775,614 S 1/2017 Kim  
 D776,647 S 1/2017 Kim  
 D777,157 S 1/2017 Kim  
 D777,160 S 1/2017 Kim  
 D777,717 S \* 1/2017 Kim ..... D14/250  
 D781,835 S 3/2017 Kim et al.  
 D781,838 S 3/2017 Kim

D781,840 S 3/2017 Kim et al.  
 D782,460 S 3/2017 Bertrand et al.  
 D783,602 S 4/2017 Akana et al.  
 D784,309 S 4/2017 Lee et al.  
 D785,615 S 5/2017 Kim et al.  
 D786,849 S 5/2017 Park et al.  
 D786,853 S 5/2017 Friedland et al.  
 D788,090 S \* 5/2017 Kim ..... D14/250  
 D788,093 S 5/2017 Lee et al.  
 9,661,116 B1 5/2017 Chung  
 D792,394 S 7/2017 Lee et al.  
 D795,237 S 8/2017 Jung et al.  
 D797,715 S 9/2017 Kim  
 D798,286 S 9/2017 Roberts et al.  
 D801,323 S 10/2017 Kim  
 D801,324 S 10/2017 Kim  
 D801,325 S 10/2017 Kim  
 D801,959 S 11/2017 Kuo et al.  
 D806,082 S \* 12/2017 Armstrong ..... D14/440  
 D810,064 S 2/2018 Kim et al.  
 D812,600 S \* 3/2018 Altaras ..... D14/250  
 D832,833 S \* 11/2018 Kim ..... D14/250  
 D838,706 S 1/2019 Li et al.  
 D838,710 S 1/2019 Wang  
 D839,861 S \* 2/2019 Kim ..... D14/250  
 D840,992 S 2/2019 Kim  
 D840,993 S \* 2/2019 Kim ..... D14/250  
 D841,637 S \* 2/2019 Kim ..... D14/250  
 D843,993 S 3/2019 Jeong et al.  
 D843,994 S 3/2019 Jeong et al.  
 D845,292 S \* 4/2019 Fitzgerald ..... D14/250  
 D847,807 S 5/2019 Wright et al.  
 D849,736 S \* 5/2019 Kim ..... D14/250  
 D849,737 S \* 5/2019 Kim ..... D14/250  
 D850,431 S 6/2019 Igarashi  
 D863,283 S \* 10/2019 Kim ..... D14/250  
 2011/0050606 A1 3/2011 Zhang  
 2014/0357330 A1 12/2014 Lin  
 2015/0053583 A1 2/2015 McCormick  
 2015/0189963 A1 7/2015 Lai

OTHER PUBLICATIONS

Spigen Rugged Armor Case for Samsung Galaxy Note 9, earliest photo review date Aug. 14, 2018, [online][site visited Mar. 31, 2020] URL: <https://www.amazon.com/Spigen-Rugged-Galaxy-Resilient-Absorption/dp/B07FLXM5KJ> (Year: 2018).\*

Carbon Fiber Case for Sony Xperia XZ4 by Beovtk, publication date Dec. 21, 2018, [online][site visited Mar. 24, 2020] URL: <https://www.amazon.com/Silicone-Leather-Flexible-Protective-Absorption/dp/B07MDFPM6H> (Year: 2018).\*

Spigen Rugged Armor Case for Samsung Galaxy s9 Review, publication date Jun. 21, 2018, [online][site visited Mar. 31, 2020] URL: <https://www.androidcentral.com/spigen-rugged-armor-case-galaxy-s9-review> (Year: 2018).\*

Caseology Parallax for iPhone X, iPhone XS, earliest photo review date Nov. 10, 2017, [online][site visited Apr. 1, 2020] URL: <https://www.amazon.com/Caseology-Parallax-iPhone-Design-Protective/dp/B0752ZV2LZ> (Year: 2017).\*

“Caseology Vault for Apple iPhone 8 Case (2017) / for iPhone 7 Case (2016)—Rugged & Flexible—Matte Black”, <https://www.amazon.com/dp/B01JSZOJ7M>, Earliest review date of Sep. 10, 2016, Downloaded on Jan. 16, 2020.

“The best iPhone 7 & 7 Plus cases available now”, <https://9to5mac.com/2016/09/07/best-iphone-7-7-plus-cases-accessories-available-now/>, Earliest review date of Sep. 17, 2016, Downloaded on Mar. 18, 2020.

“Caseology Vault for Google Pixel Case (2016)—Rugged & Flexible—Black”, <https://www.amazon.com/dp/B01MEDIMGS>, Earliest review date of Nov. 10, 2016, Downloaded on Jan. 16, 2020.

“Caseology Vault for Apple iPhone 7 Plus Case (2016)—Rugged Matte Finish—Black”, <https://www.amazon.com/dp/B01N2OCQV4>, Earliest review date of Dec. 16, 2016, Downloaded on Jan. 16, 2020.

(56)

References Cited

OTHER PUBLICATIONS

- “Caseology Vault for LG G6 Case (2017)—Rugged Matte Finish—Black”, <https://www.amazon.com/dp/B06W52JLH>, Earliest review date of Mar. 28, 2017, Downloaded on Jan. 16, 2020.
- “Caseology Nero Tough for iPhone 8 Plus Case (2017) / iPhone 7 Plus Case (2016)—360 Protection—Black”, <https://www.amazon.com/dp/B07534JMM2>, Earliest review date of Aug. 23, 2017, Downloaded on Nov. 19, 2019.
- “Spigen Rugged Armor Galaxy S6 Case with Resilient Shock Absorption and Carbon Fiber Design for Galaxy S6 2015—Black”, <https://www.amazon.com/dp/B00T6P05ZK>, Earliest review date of Mar. 10, 2015, Downloaded on Jul. 17, 2018.
- “Spigen Rugged Armor Galaxy S6 Edge Case with Flexible and Durable Shock Absorption with Carbon Fiber Design for Samsung Galaxy S6 Edge (2015)—Black”, <https://www.amazon.com/dp/B00SVCITW0>, Earliest review date of Mar. 13, 2015, Downloaded on Jul. 17, 2018.
- “Spigen Rugged Armor Galaxy Note 5 Case with Resilient Shock Absorption and Carbon Fiber Design for Galaxy Note 5 2015—Black”, <https://www.amazon.com/dp/B010MWFUBY>, Earliest review date of Aug. 23, 2015, Downloaded on Jul. 17, 2018.
- “Spigen Rugged Armor iPhone 6S Case with Resilient Shock Absorption and Carbon Fiber Design for iPhone 6S/iPhone 6—Black”, <https://www.amazon.com/dp/B010MVJM5K>, Earliest review date of Sep. 3, 2015, Downloaded on Jul. 17, 2018.
- “Spigen Rugged Armor iPhone 6S Plus Case with Resilient Shock Absorption and Carbon Fiber Design for iPhone 6S Plus 2015—Black”, <https://www.amazon.com/dp/B010MVR76Q>, Earliest review date of Sep. 7, 2015, Downloaded on Jul. 17, 2018.
- “Spigen Tough Armor Tech iPhone 6S Case with Extreme Shock and Drop Protection for Apple iPhone 6 / 6S—Gunmetal”, <https://www.amazon.com/Spigen-Tough-iPhone-Extreme-Protection/dp/B013TKNSIS>, Earliest review date of Oct. 3, 2015, Downloaded on Jan. 15, 2019.
- “Spigen Rugged Armor Samsung Galaxy S7 Case with Resilient Shock Absorption and Carbon Fiber Design for Samsung Galaxy S7 2016—Black”, <https://www.amazon.com/Spigen-Rugged-Designed-Samsung-Galaxy/dp/B01A7ICWTC>, Earliest review date of Feb. 25, 2016, Downloaded on Jul. 17, 2018.
- “Spigen Rugged Armor Galaxy S7 Edge Case with Flexible and Durable Shock Absorption with Carbon Fiber Design for Samsung Galaxy S7 Edge (2016)—Black”, <https://www.amazon.com/Spigen-Rugged-Designed-Samsung-Galaxy/dp/B01A7IDHOU>, Earliest review date of Feb. 28, 2016, Downloaded on Jul. 17, 2018.
- “Spigen Rugged Armor Galaxy A5 Case with Resilient Shock Absorption and Carbon Fiber Design for Galaxy A5—Black”, <https://www.amazon.com/Spigen-Rugged-Designed-Samsung-Galaxy/dp/B018J07A46>, Earliest review date of Mar. 18, 2016, Downloaded on Jul. 17, 2018.
- “Spigen Rugged Armor iPhone SE Case with Resilient Shock Absorption and Carbon Fiber Design for iPhone SE 2016—Black”, <https://www.amazon.com/Spigen-Rugged-iPhone-Resilient-Absorption/dp/B01BEDNUDK>, Earliest review date of Apr. 10, 2016, Downloaded on Jan. 15, 2019.
- “Spigen Rugged Armor Honor 5X Case with Resilient Shock Absorption and Carbon Fiber Design for Huawei Honor 5X—Black”, <https://www.amazon.com/Spigen-Rugged-Resilient-Absorption-Carbon/dp/B01DJHHXD2>, Earliest review date of May 1, 2016, Downloaded on Jan. 15, 2019.
- “Spigen Rugged Armor HTC 10 Case with Resilient Shock Absorption and Carbon Fiber Design for HTC 10 2016—Black”, <https://www.amazon.com/dp/B01DAN1T4E>, Earliest review date of May 4, 2016, Downloaded on Jul. 18, 2018.
- “Spigen Rugged Armor Huawei P8 Lite Case with Resilient Shock Absorption and Carbon Fiber Design for Huawei P8 Lite (2015)—Black”, <https://www.amazon.com/dp/B01DL0DME6>, Earliest review date of Jun. 1, 2016, Downloaded on Jul. 18, 2018.
- “Spigen Rugged Armor OnePlus 3 Case/OnePlus 3T Case with Resilient Shock Absorption and Carbon Fiber Design for OnePlus 3 2016—Black”, <https://www.amazon.com/dp/B01H3PEWDK>, Earliest review date of Jul. 28, 2016, Downloaded on Jul. 17, 2018.
- “Spigen Rugged Armor iPhone 8 Case / iPhone 7 Case with Resilient Shock Absorption and Carbon Fiber Design for Apple iPhone 8 (2017) / iPhone 7 (2016)—Black”, <https://www.amazon.co.uk/Spigen-Rugged-iPhone-Resilient-Absorption/dp/B01GIVX7TA>, Earliest review date of Aug. 2, 2016, downloaded on Oct. 24, 2018.
- “Spigen Rugged Armor iPhone 8 Plus/iPhone 7 Plus Case with Resilient Shock Absorption and Carbon Fiber Design for Apple iPhone 8 Plus (2017)/iPhone 7 Plus (2016)—Black”, <https://www.amazon.com/dp/B01GIWGAAC>, Earliest review date of Sep. 2, 2016, Downloaded on Jul. 17, 2018.
- “Spigen Rugged Armor Huawei P9 Lite Case with Resilient Shock Absorption and Carbon Fiber Design for Huawei P9 Lite—Black”, <https://www.amazon.com/B01DL0DJGM>, Earliest review date of Sep. 6, 2016, Downloaded on Jul. 18, 2018.
- “Spigen Rugged Armor iPhone 8 Case/iPhone 7 Case with Resilient Shock Absorption and Carbon Fiber Design for Apple iPhone 8 (2017)/iPhone 7 (2016)—Black”, <https://www.amazon.com/dp/B01GIVX7TA>, Earliest review date of Sep. 11, 2016, Downloaded on Jul. 17, 2018.
- “Spigen Rugged Armor Google Pixel XL Case with Resilient Shock Absorption and Carbon Fiber Design for Google Pixel XL 2016—Black”, <https://www.amazon.com/dp/B01M1EEXWJ>, Earliest review date of Oct. 2, 2016, Downloaded on Jul. 17, 2018.
- “Spigen Rugged Armor LG V20 Case with Resilient Shock Absorption and Carbon Fiber Design for LG V20 2016—Black”, <https://www.amazon.com/dp/B01M0HW9P4>, Earliest review date of Oct. 19, 2016, Downloaded on Jul. 18, 2018.
- “Spigen Rugged Armor Honor 8 Case with Resilient Shock Absorption for Huawei Honor 8 2016—Black”, <https://www.amazon.com/dp/B01LXTROW1>, Earliest review date of Oct. 20, 2016, Downloaded on Jul. 18, 2018.
- “Spigen Rugged Armor Moto Z Droid Case with Resilient Shock Absorption and Carbon Fiber Design for Moto Z Droid 2016—Black”, <https://www.amazon.com/dp/B01HCAQMBQ>, Earliest review date of Dec. 9, 2016, Downloaded on Jul. 17, 2018.
- “Spigen Rugged Armor Galaxy A3 2016 Case with Resilient Shock Absorption and Carbon Fiber Design for Galaxy A3 2016—Black”, <https://www.amazon.com/Spigen-Rugged-Armor-Samsung-Galaxy/dp/B01HFMYLIC>, Earliest review date of Dec. 18, 2016, Downloaded on Jul. 17, 2018.
- “Spigen Rugged Armor ZenFone 3 Max Case (ZC520TL) with Resilient Shock Absorption and Carbon Fiber Design for ASUS ZenFone 3 Max (ZC520TL)—Black”, <https://www.amazon.com/dp/B01MSDJQ7C>, Earliest review date of Mar. 9, 2017, Downloaded on Jul. 18, 2018.
- “Spigen Rugged Armor Extra Designed for LG G6 Case (2017) / Designed for LG G6 Plus (2017)—Black”, <https://www.amazon.com/Spigen-Rugged-Resilient-Absorption-Carbon/dp/B01N6T9PHS>, Earliest review date of Mar. 28, 2017, Downloaded on Jan. 9, 2020.
- “Spigen Rugged Armor LG G6 Case/G6 Plus Case with Resilient Shock Absorption and Carbon Fiber Design for LG G6/G6 Plus (2017)—Black”, <https://www.amazon.com/dp/B01MUCZILA>, Earliest review date of Mar. 30, 2017, Downloaded on Jul. 18, 2018.
- “Spigen Rugged Armor Galaxy S8 Plus Case with Resilient Shock Absorption and Carbon Fiber Design for Galaxy S8 Plus (2017)—Black”, <https://www.amazon.com/Spigen-Rugged-Designed-Samsung-Galaxy/dp/B06XNW4ZVJ>, Earliest review date of Apr. 3, 2017, Downloaded on Jul. 17, 2018.
- “Spigen Rugged Armor Galaxy S8 Case with Resilient Shock Absorption and Carbon Fiber Design for Samsung Galaxy S8 (2017)—Black”, <https://www.amazon.com/Spigen-Rugged-Designed-Samsung-Galaxy/dp/B06XNNJ4KM>, Earliest review date of Apr. 7, 2017, Downloaded on Jul. 17, 2018.
- Spigen, “Spigen Rugged Armor Extra”, <https://www.youtube.com/watch?v=ILUEjn1P2hk>, Published May 26, 2017, downloaded on Jan. 9, 2020.
- “Spigen Rugged Armor Huawei P10 Plus Case with Resilient Shock Absorption and Carbon Fiber Design for Huawei P10 Plus(2017)—

(56)

**References Cited**

## OTHER PUBLICATIONS

Rugged Armor”, <https://www.amazon.com/dp/B06XFZW779>, Earliest review date of May 26, 2017, Downloaded on Jul. 18, 2018.

“Spigen Rugged Armor Galaxy J7 2017 Case, J7 Prime, J7 2017(AT &T), J7 Sky Pro, J7 Perx case with Resilient Shock Absorption and Carbon Fiber Design for Samsung Galaxy J7 V 2017—Black”, <https://www.amazon.com/Spigen-Rugged-Resilient-Absorption-Samsung/dp/B06WRRF36B>, Earliest review date of May 31, 2017, Downloaded on Jan. 15, 2019.

“Spigen Rugged Armor Huawei P10 Lite Case with Resilient Shock Absorption and Carbon Fiber Design for Huawei P10 Lite (2017)—Black”, <https://www.amazon.com/dp/B06XC�Q3S4>, Earliest review date of Jun. 7, 2017, Downloaded on Jul. 18, 2018.

“Spigen Rugged Armor Huawei P10 Case with Resilient Shock Absorption and Carbon Fiber Design for Huawei P10 (2017)—Black”, <https://www.amazon.com/dp/B06XCTQR1W>, Earliest review date of Jun. 8, 2017, Downloaded on Jul. 18, 2018.

“Spigen Rugged Armor HTC U11 Case with Resilient Shock Absorption and Carbon Fiber Design for HTC U 11 (2017)—Black”, <https://www.amazon.com/dp/B07234FLGX>, Earliest review date of Jun. 17, 2017, Downloaded on Jul. 18, 2018.

“Spigen Rugged Armor Huawei P8 Lite 2017 Case with Resilient Shock Absorption and Carbon Fiber Design for Huawei P8 Lite (2017)/nova lite/P9 lite 2017/Honor 8 lite—Black”, <https://www.amazon.com/dp/B06XFVXMLN>, Earliest review date of Jun. 24, 2017, Downloaded on Jul. 18, 2018.

“Spigen Rugged Armor Extra Galaxy Temp Case with Resilient Shock Absorption and Carbon Fiber Design for Galaxy Temp (2017)—Black”, <https://www.amazon.com/Spigen-Rugged-Galaxy-Resilient-Absorption/dp/B01MTEQVNB>, Earliest review date of Jul. 6, 2017, downloaded on Jan. 9, 2020.

“Spigen Rugged Armor Sony Xperia XZ Premium Case with Resilient Shock Absorption and Carbon Fiber Design for Sony

Xperia XZ Premium (2017)—Black”, <https://www.amazon.com/dp/B072PRXPQC>, Earliest review date of Jul. 14, 2017, Downloaded on Jul. 18, 2018.

“Spigen Rugged Armor OnePlus 5 Case with Resilient Shock Absorption and Carbon Fiber Design for OnePlus 5 (2017)—Black”, <https://www.amazon.com/dp/B06XG19W3G>, Earliest review date of Jul. 25, 2017, Downloaded on Jul. 17, 2018.

“Spigen Rugged Armor Moto Z2 Play Case with Resilient Shock Absorption and Carbon Fiber Design for Moto Z2 Play—Black”, <https://www.amazon.com/dp/B071WR4H9V>, Earliest review date of Jul. 27, 2017, Downloaded on Jul. 17, 2018.

“Spigen Rugged Armor Galaxy Note 8 Case with Resilient Shock Absorption and Carbon Fiber Design for Galaxy Note 8 (2017)—Matte Black”, <https://www.amazon.com/Spigen-Rugged-Galaxy-Resilient-Absorption/dp/B073RWJ6Z7>, Earliest review date of Aug. 26, 2017, Downloaded on Jan. 15, 2019.

“Spigen Rugged Armor Galaxy Note 8 Case with Resilient Shock Absorption and Carbon Fiber Design for Galaxy Note 8 (2017)—Matte Black”, <https://www.amazon.com/Spigen-Rugged-Designed-Samsung-Galaxy/dp/B073RWJ6Z7>, Earliest review date of Aug. 26, 2017, Downloaded on Jul. 17, 2018.

“Spigen Rugged Crystal Designed for Samsung Galaxy Note 8 Case (2017)—Crystal Clear”, <https://www.amazon.com/Spigen-Rugged-Crystal-Designed-Samsung/dp/B073RWTZ5M>, Earliest review date of Aug. 30, 2017, downloaded on Jan. 9, 2020.

“Spigen Rugged Armor Moto E4 Case with Resilient Shock Absorption and Carbon Fiber Design for Moto E4 (2017)—Black”, <https://www.amazon.com/Spigen-Rugged-Armor-Designed-Motorola/dp/B073RVC6YY>, Earliest review date of Sep. 5, 2017, Downloaded on Jul. 17, 2018.

“Spigen Rugged Armor Extra Designed for Apple iPhone 7 Case (2016)—Black”, <https://www.amazon.com/Spigen-Rugged-iPhone-Resilient-Absorption/dp/B06XC8WL7P>, Earliest review date of Sep. 7, 2017, downloaded on Jan. 9, 2020.

\* cited by examiner

FIG. 1

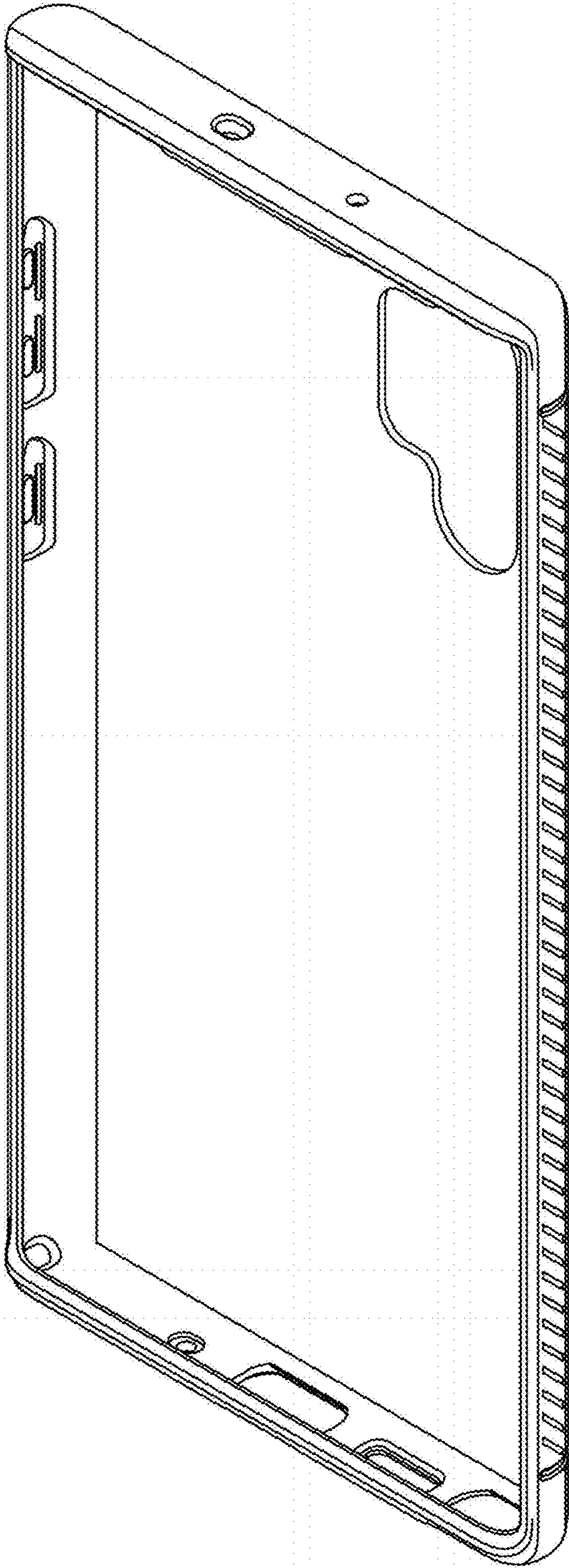

FIG. 2

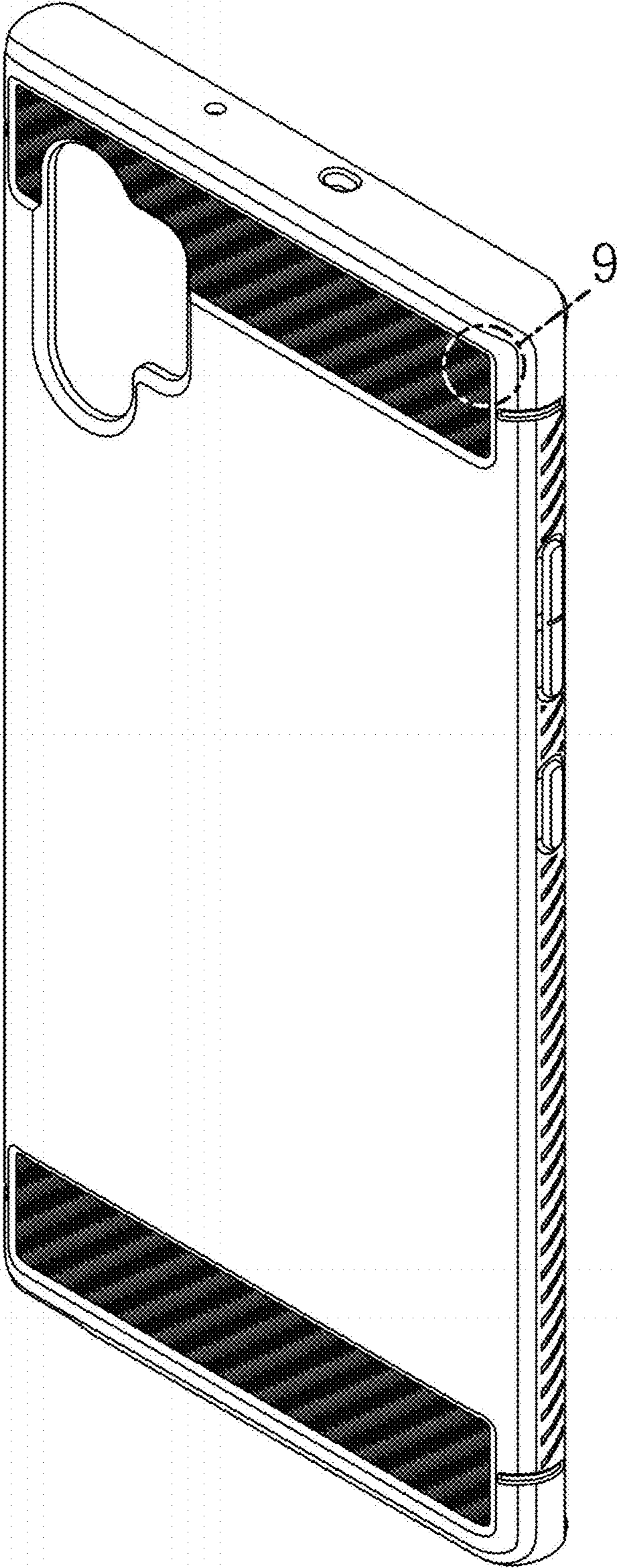

FIG. 3

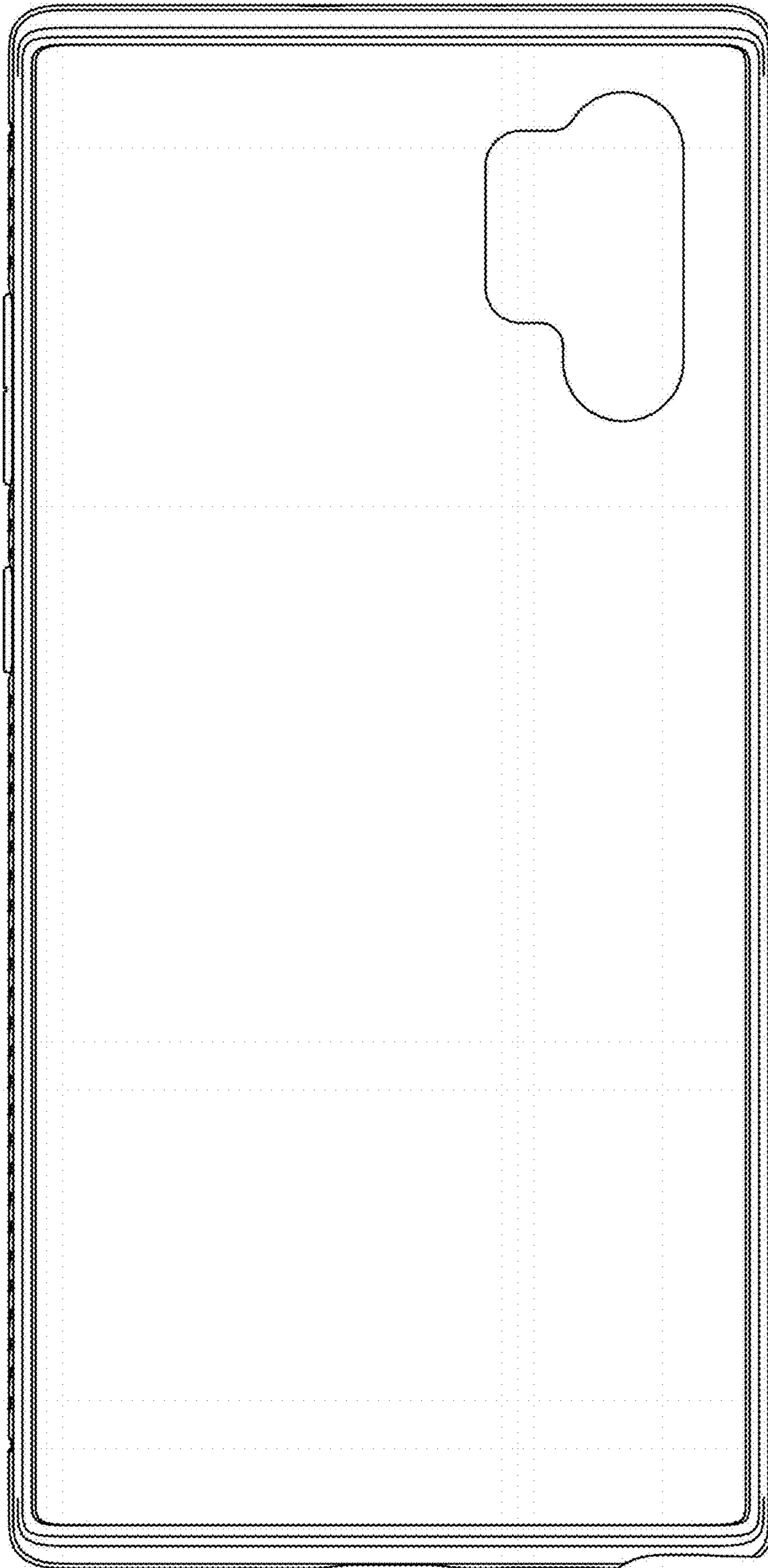

FIG. 4

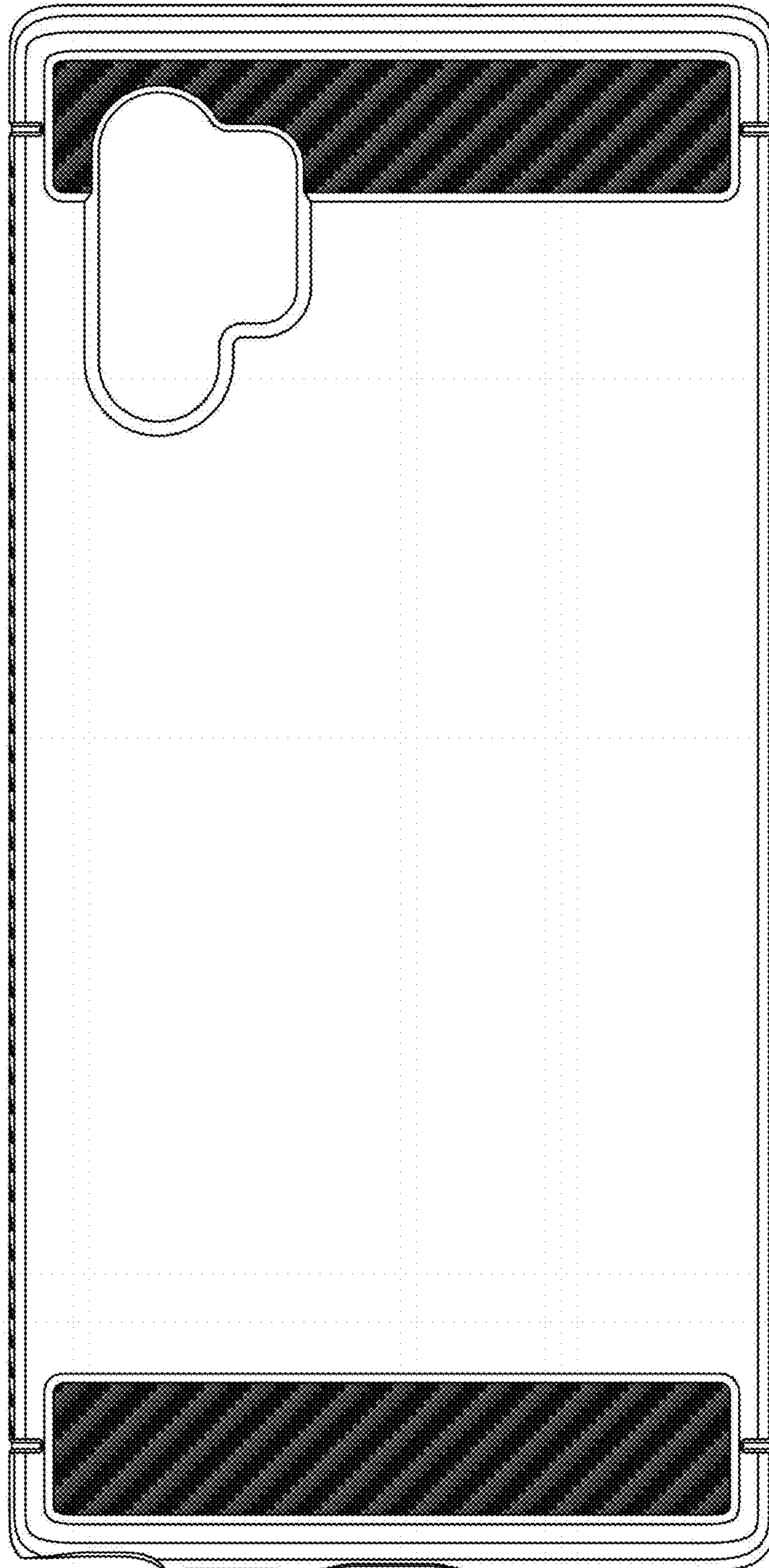



FIG. 5

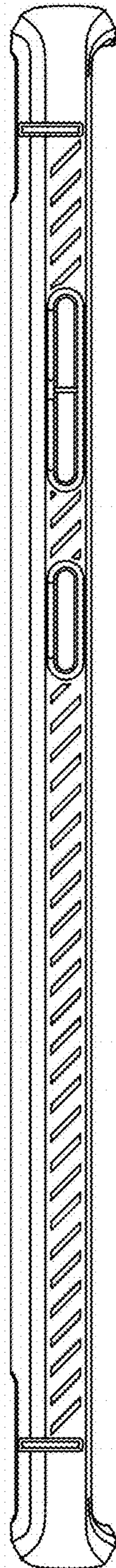

FIG. 6

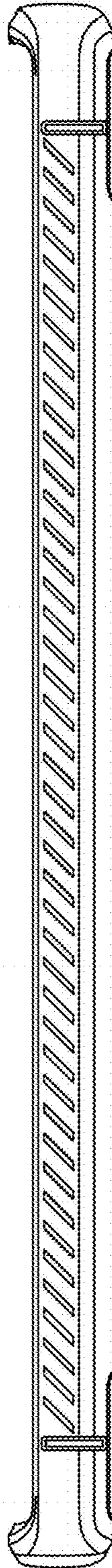

FIG. 7

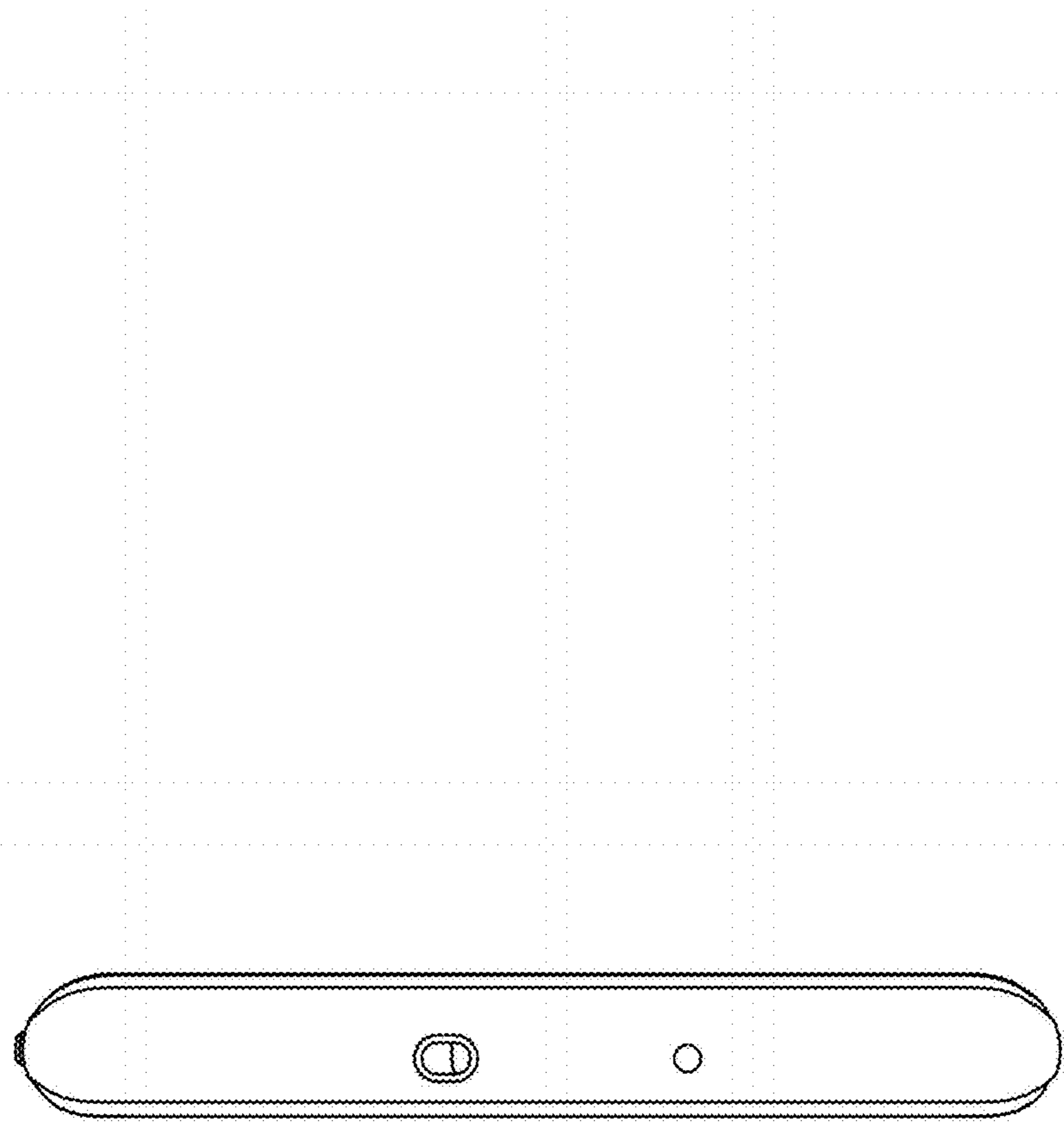

FIG. 8

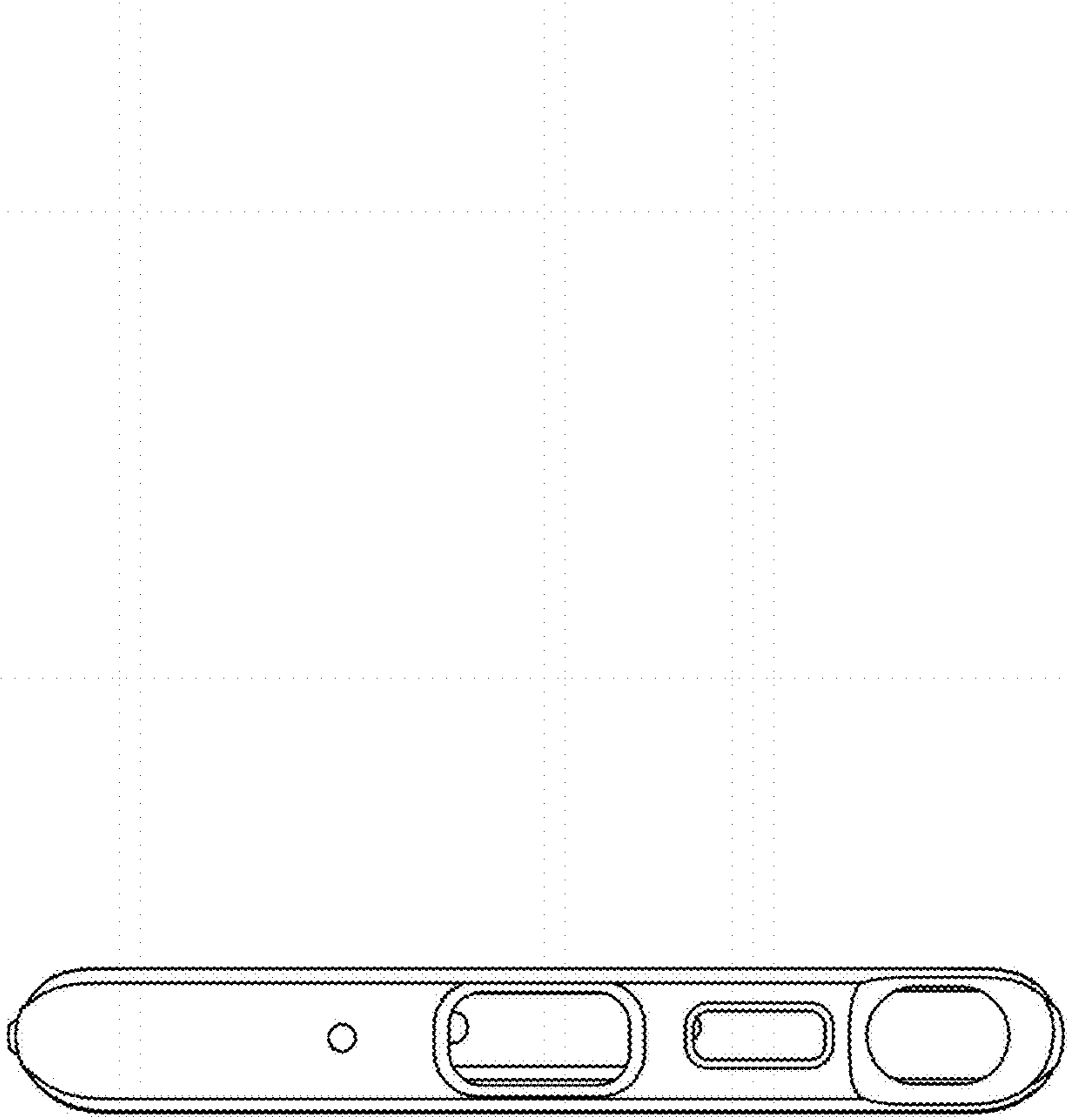

FIG. 9

