



US00D931777S

(12) **United States Design Patent** (10) **Patent No.:** **US D931,777 S**
Ueda et al. (45) **Date of Patent:** **** Sep. 28, 2021**

(54) **AUTOMOTIVE WHEEL**
(71) Applicant: **SONY CORPORATION**, Tokyo (JP)
(72) Inventors: **Arinobu Ueda**, Tokyo (JP); **Daisuke Ishii**, Kanagawa (JP)
(73) Assignee: **SONY CORPORATION**, Tokyo (JP)
(**) Term: **15 Years**
(21) Appl. No.: **29/728,600**
(22) Filed: **Mar. 19, 2020**
(30) **Foreign Application Priority Data**
Dec. 27, 2019 (JP) 2019-029280
Dec. 27, 2019 (JP) 2019-029281
(51) **LOC (13) Cl.** **12-16**
(52) **U.S. Cl.**
USPC **D12/209; D21/563**
(58) **Field of Classification Search**
USPC D12/204-213; D21/563
CPC B60B 7/00; B60B 7/02; B60B 7/04; B60B 7/01; B60B 7/06; B60B 3/02; B60B 3/04; B60B 3/06; B60B 3/10; B60B 1/00; B60B 1/08; B60B 1/10; B60B 1/12
See application file for complete search history.

(56) **References Cited**
U.S. PATENT DOCUMENTS
D574,311 S * 8/2008 Chung D12/209
D655,657 S * 3/2012 Juergens D12/209
D660,767 S * 5/2012 von Holzhausen D12/209
D686,132 S * 7/2013 Truebsbach D12/209
D756,287 S * 5/2016 Koglin D12/211
D756,878 S * 5/2016 Valencia Pollex D12/209
D781,769 S * 3/2017 Valencia Pollex D12/211
D788,003 S * 5/2017 Conforzi D12/209
D790,422 S * 6/2017 Hodges D12/209
D798,217 S * 9/2017 Valencia Pollex D12/211

D826,126 S * 8/2018 Valencia Pollex D12/209
D826,826 S * 8/2018 Back D12/209
D838,224 S * 1/2019 Valencia Pollex D12/209
D869,367 S * 12/2019 Rosello Visa D12/209
D877,028 S * 3/2020 Kusunoki D12/209
D879,002 S * 3/2020 Daniel D12/209
D887,941 S * 6/2020 Han D12/209
D892,014 S * 8/2020 Cenana D12/209
D913,182 S * 3/2021 Ma D12/209

* cited by examiner
Primary Examiner — Stacia A Cadmus
(74) *Attorney, Agent, or Firm* — Michael Best and Friedrich LLP

(57) **CLAIM**
The ornamental design for an automotive wheel, as shown and described.

DESCRIPTION
FIG. 1 is a front, top, right perspective view of a first embodiment of an automotive wheel showing our new design;
FIG. 2 is a front, top perspective view thereof;
FIG. 3 is a front elevational view thereof;
FIG. 4 is a left side elevational view thereof;
FIG. 5 is a right side elevational view thereof;
FIG. 6 is a top plan view thereof;
FIG. 7 is a bottom plan view thereof.
FIG. 8 is a front, top, right perspective view of a second embodiment of an automotive wheel showing our new design;
FIG. 9 is a front, top perspective view of FIG. 8;
FIG. 10 is a front elevational view of FIG. 8;
FIG. 11 is a left side elevational view of FIG. 8;
FIG. 12 is a right side elevational view of FIG. 8;
FIG. 13 is a top plan view of FIG. 8; and,
FIG. 14 is a bottom plan view of FIG. 8.
Rear elevational views of the embodiments of FIGS. 1 and 8 are not part of the claimed design.

1 Claim, 14 Drawing Sheets

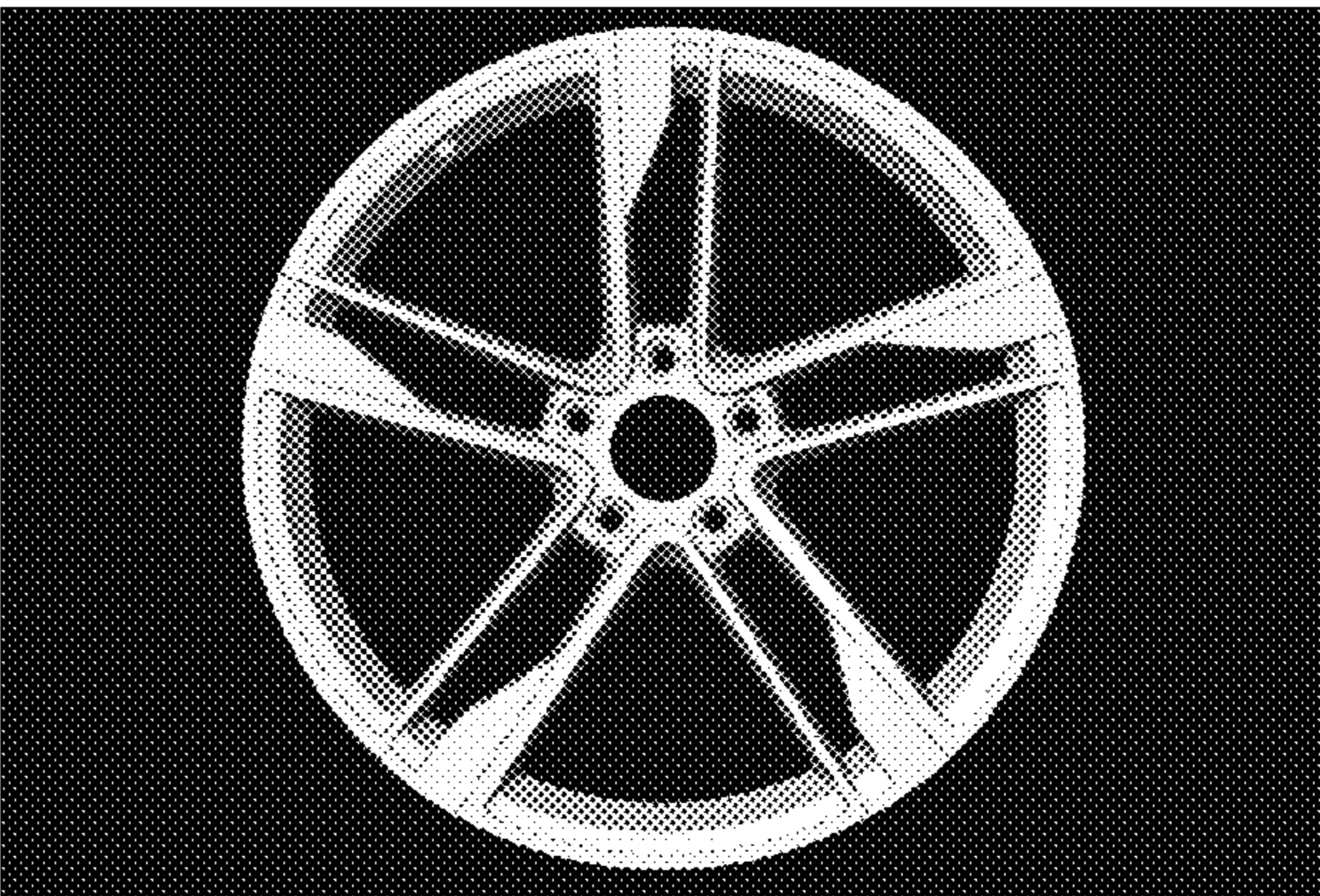
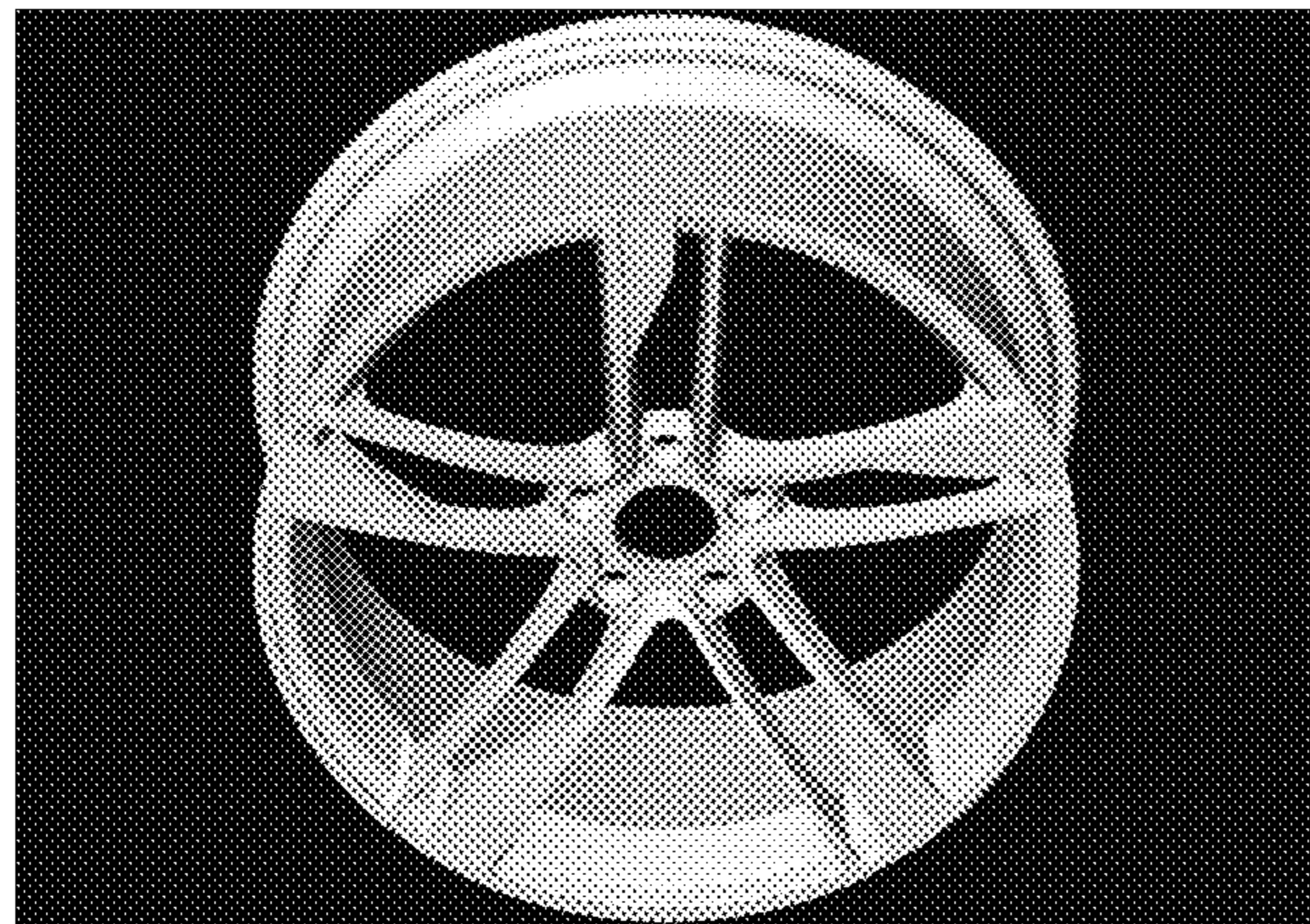

FIG.1



FIG.2

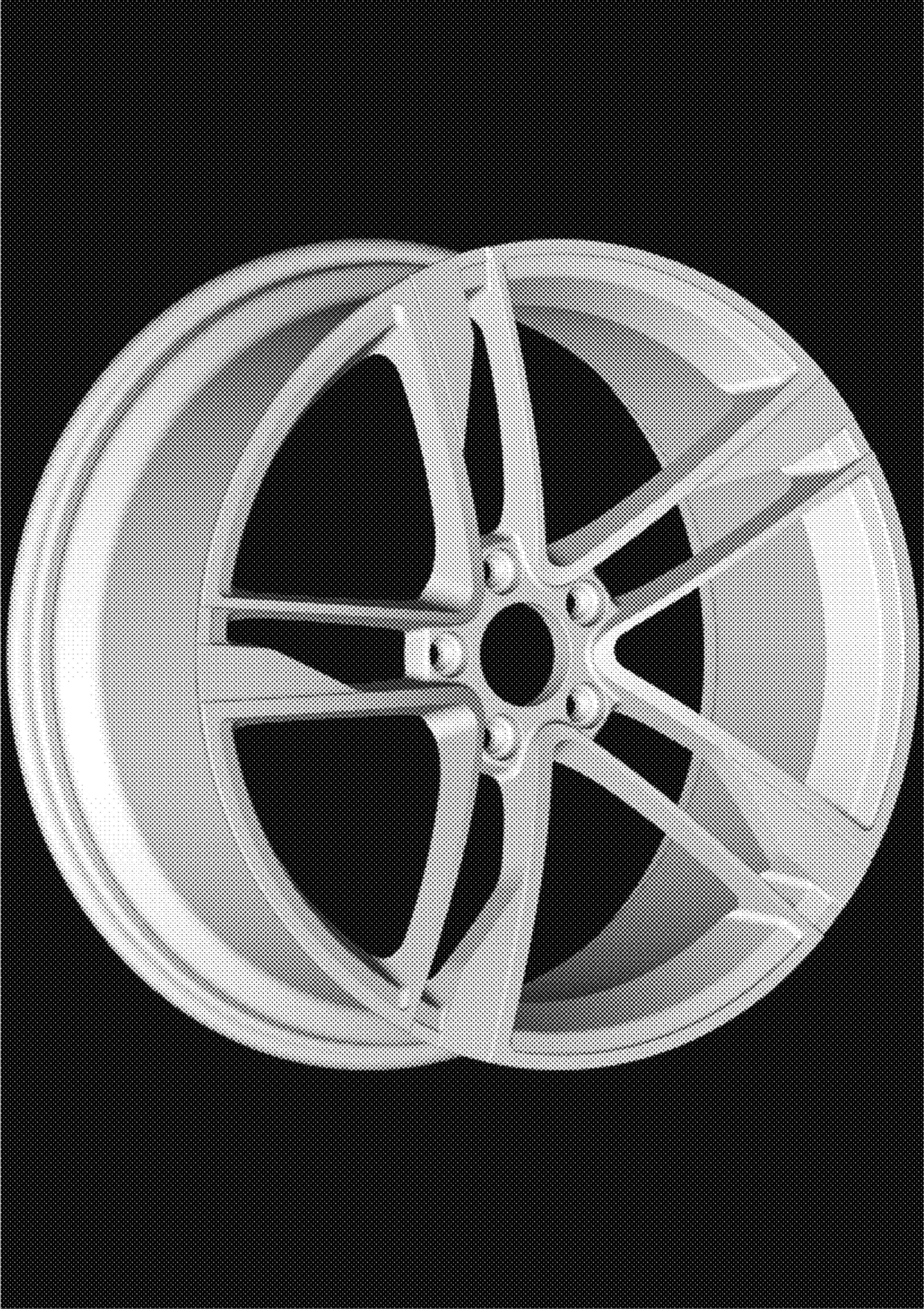

FIG.3



FIG.4

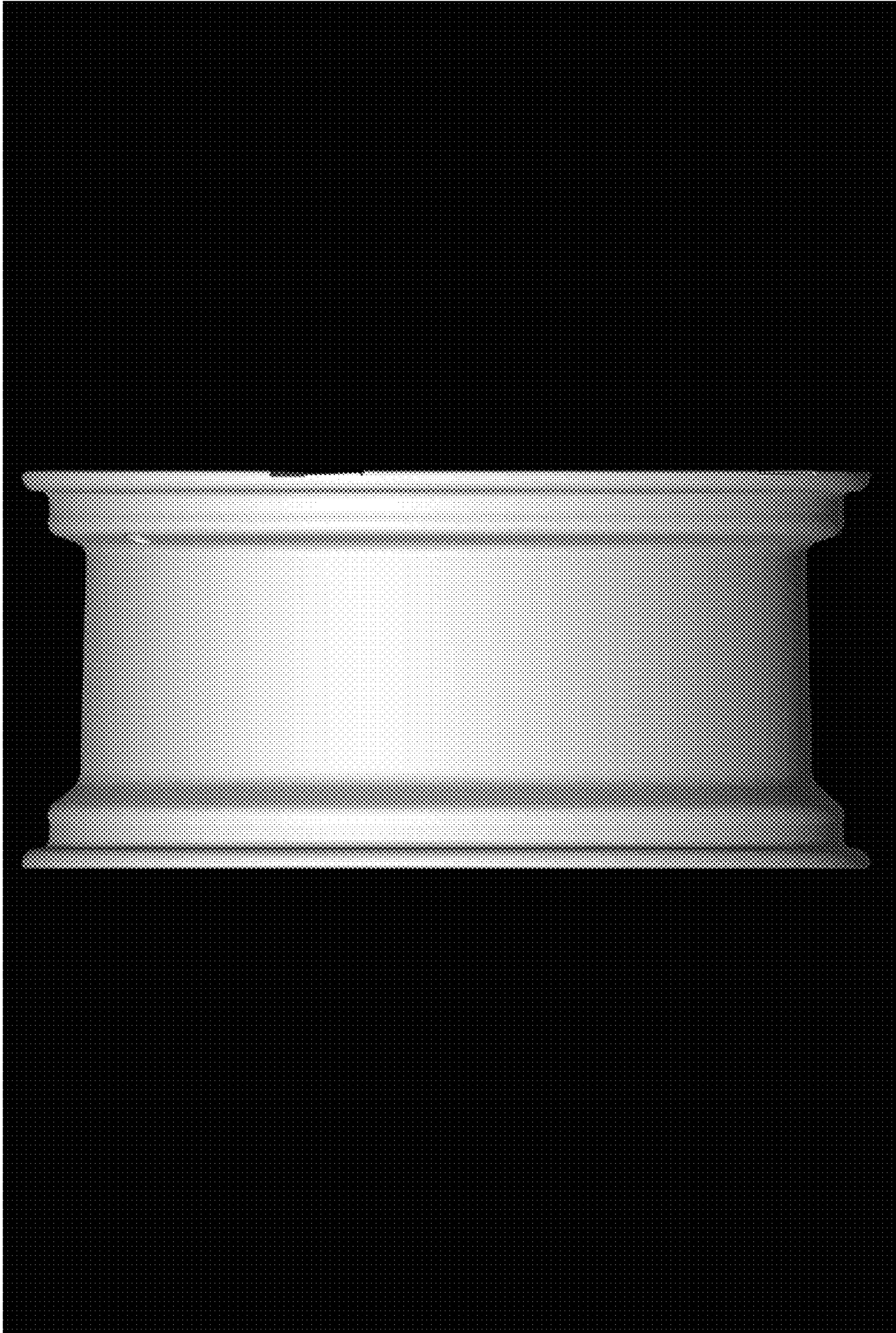

FIG. 5

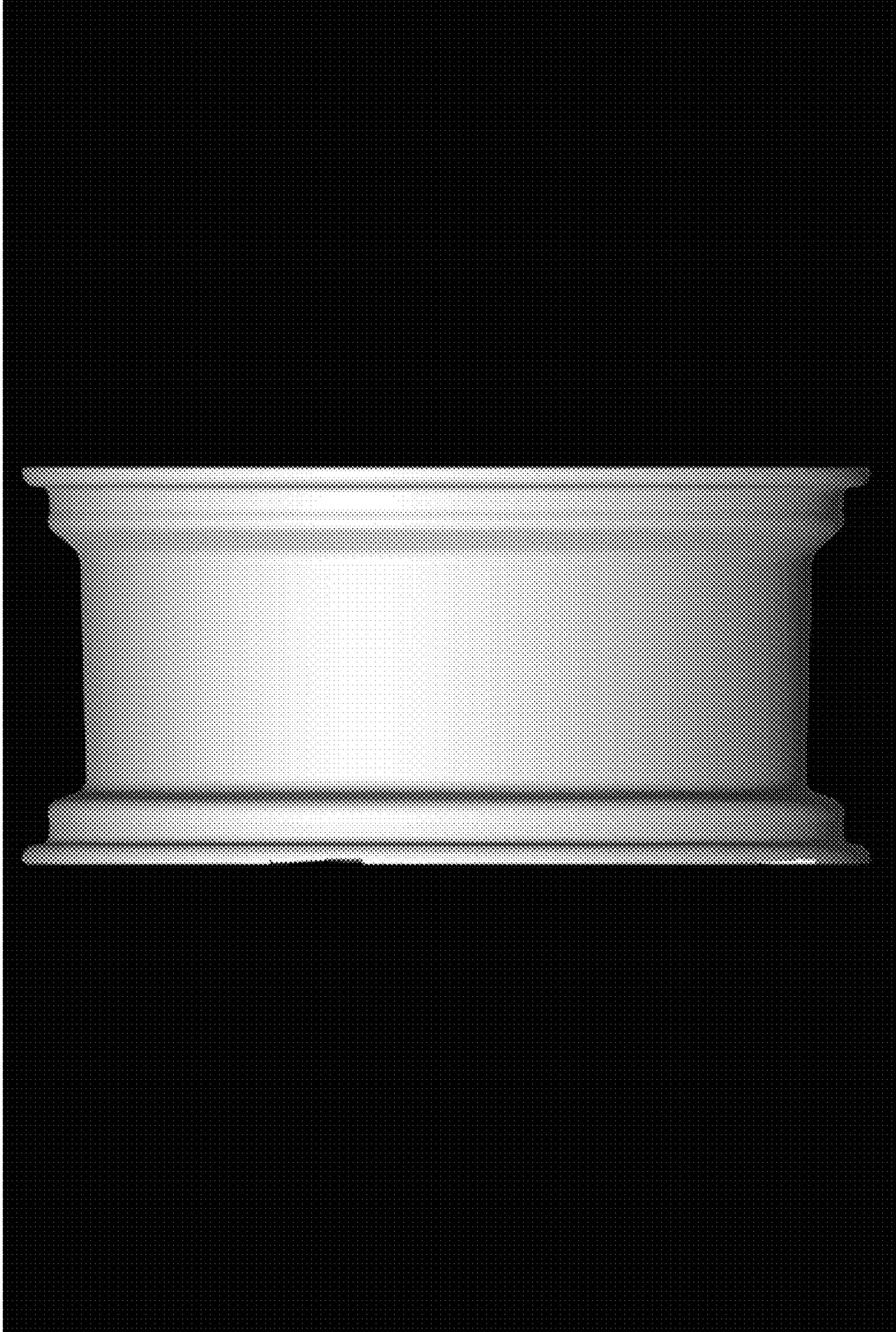

FIG.6

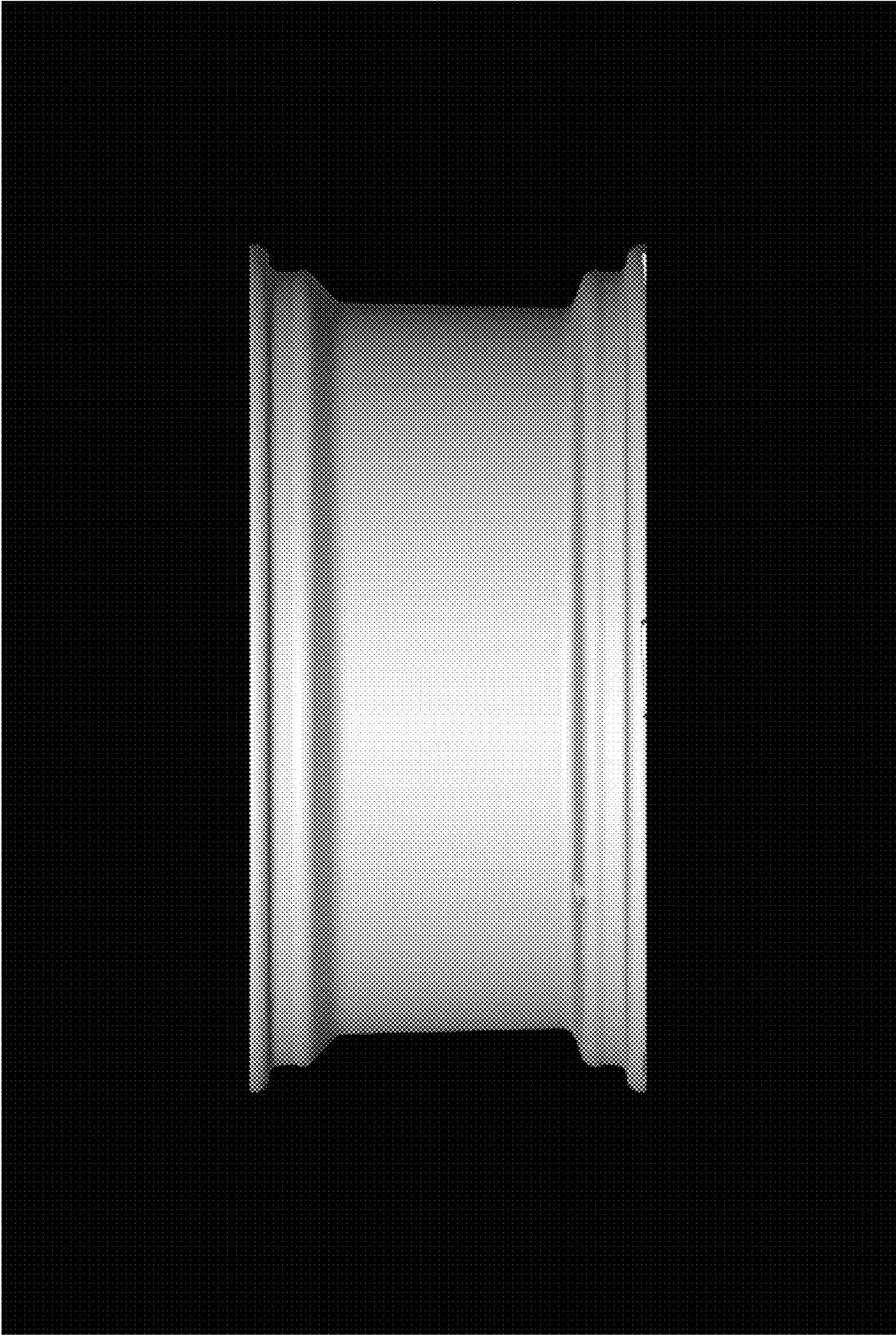

FIG.7

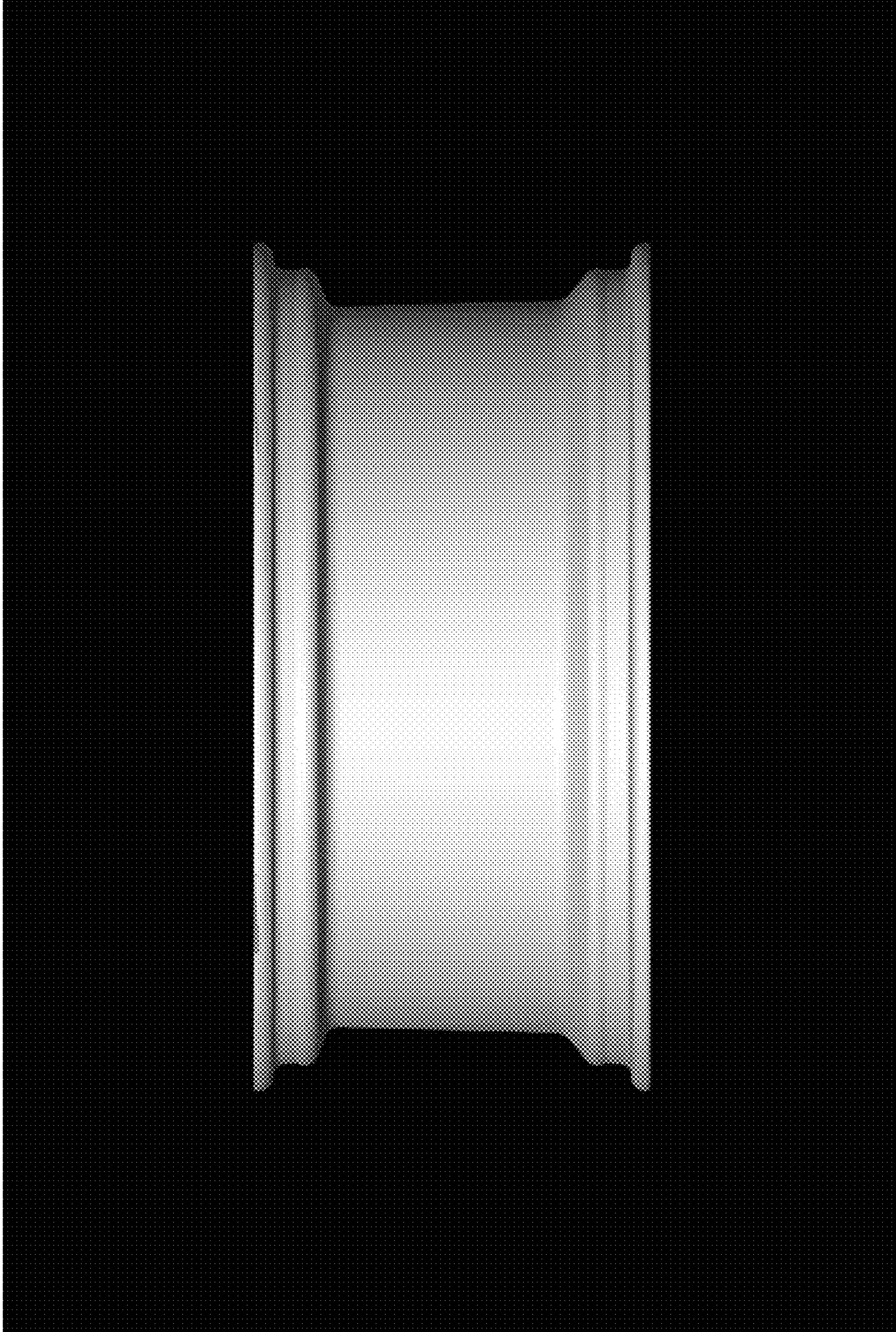

FIG.8



FIG. 9

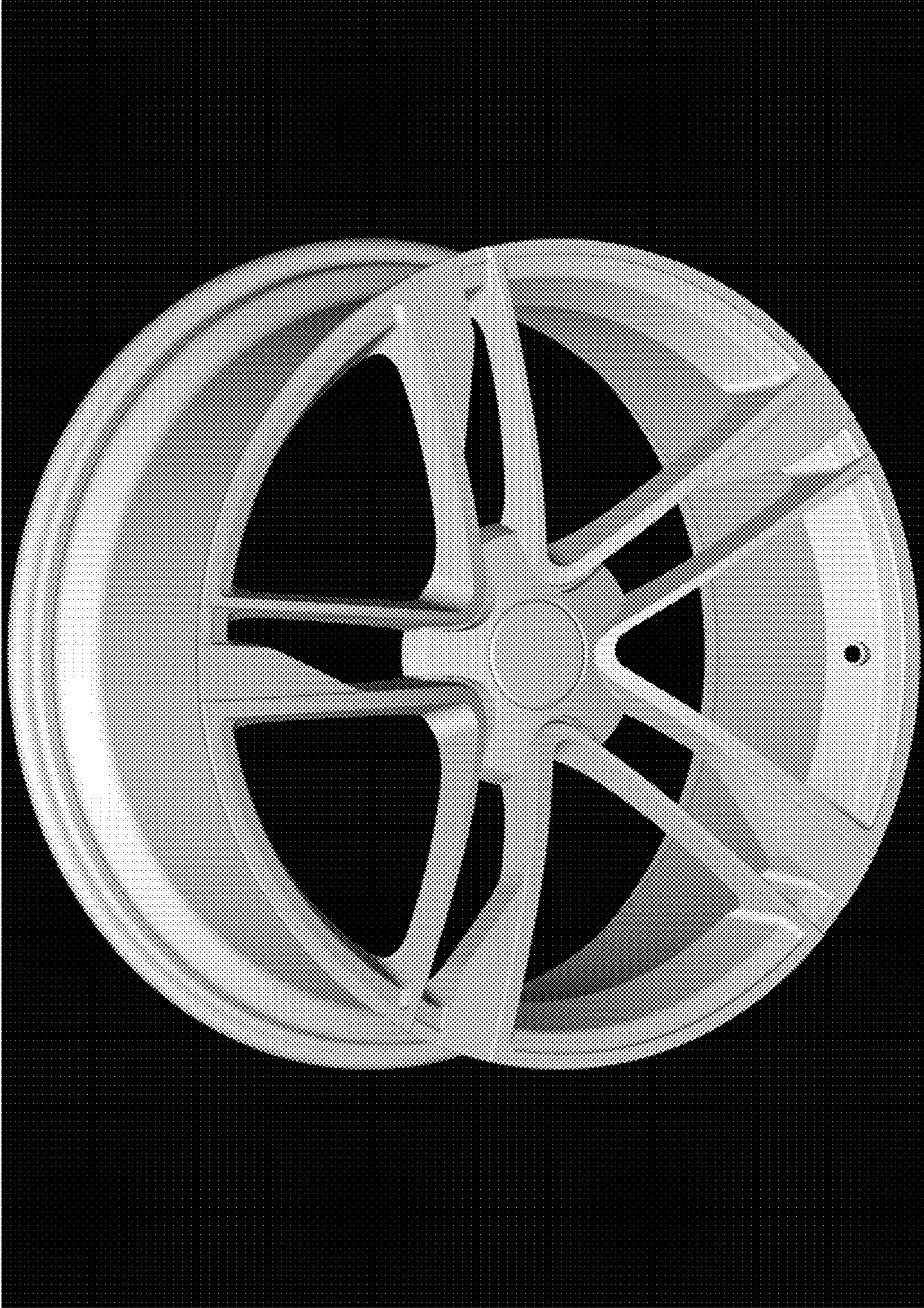

FIG.10



FIG.11

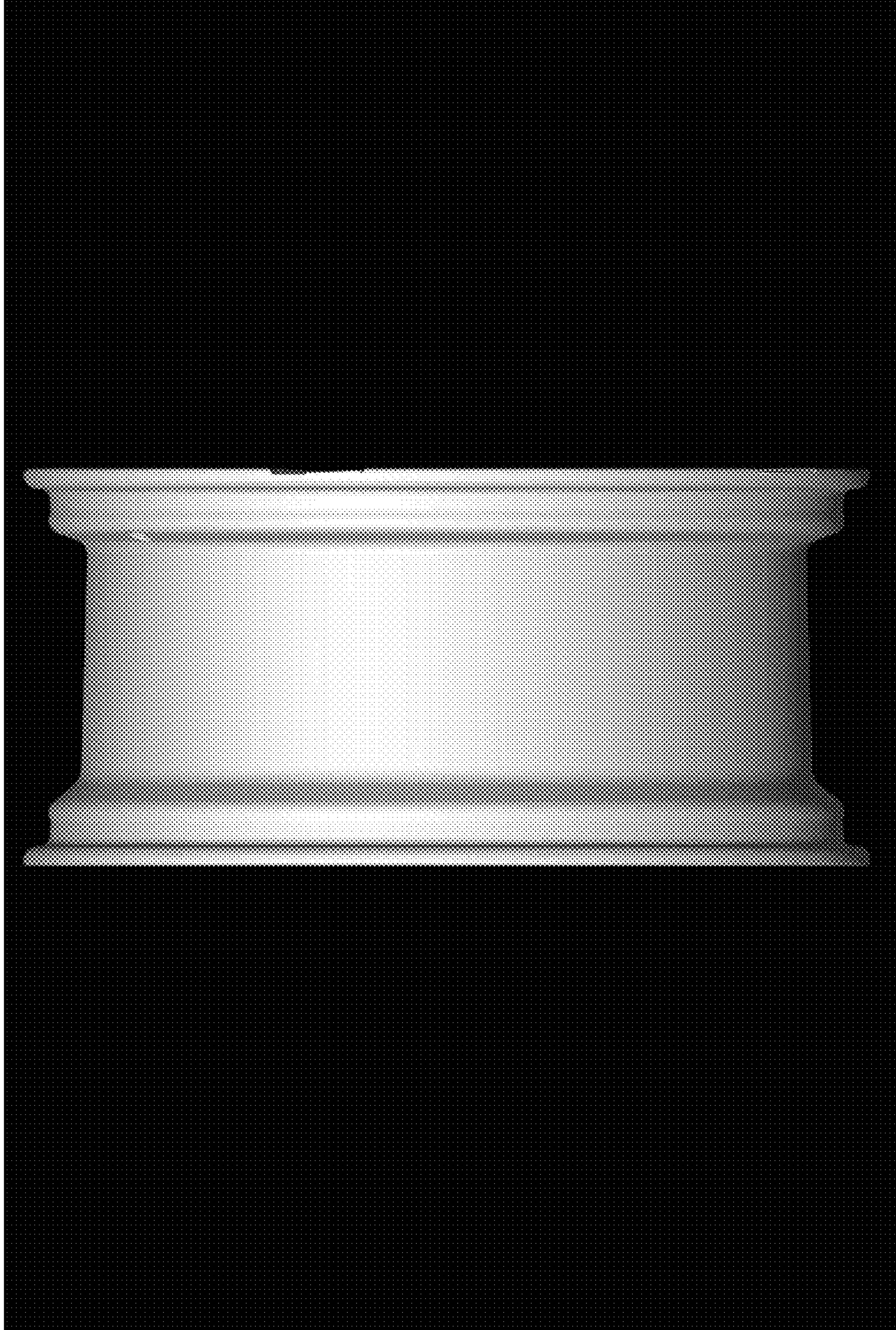

FIG.12

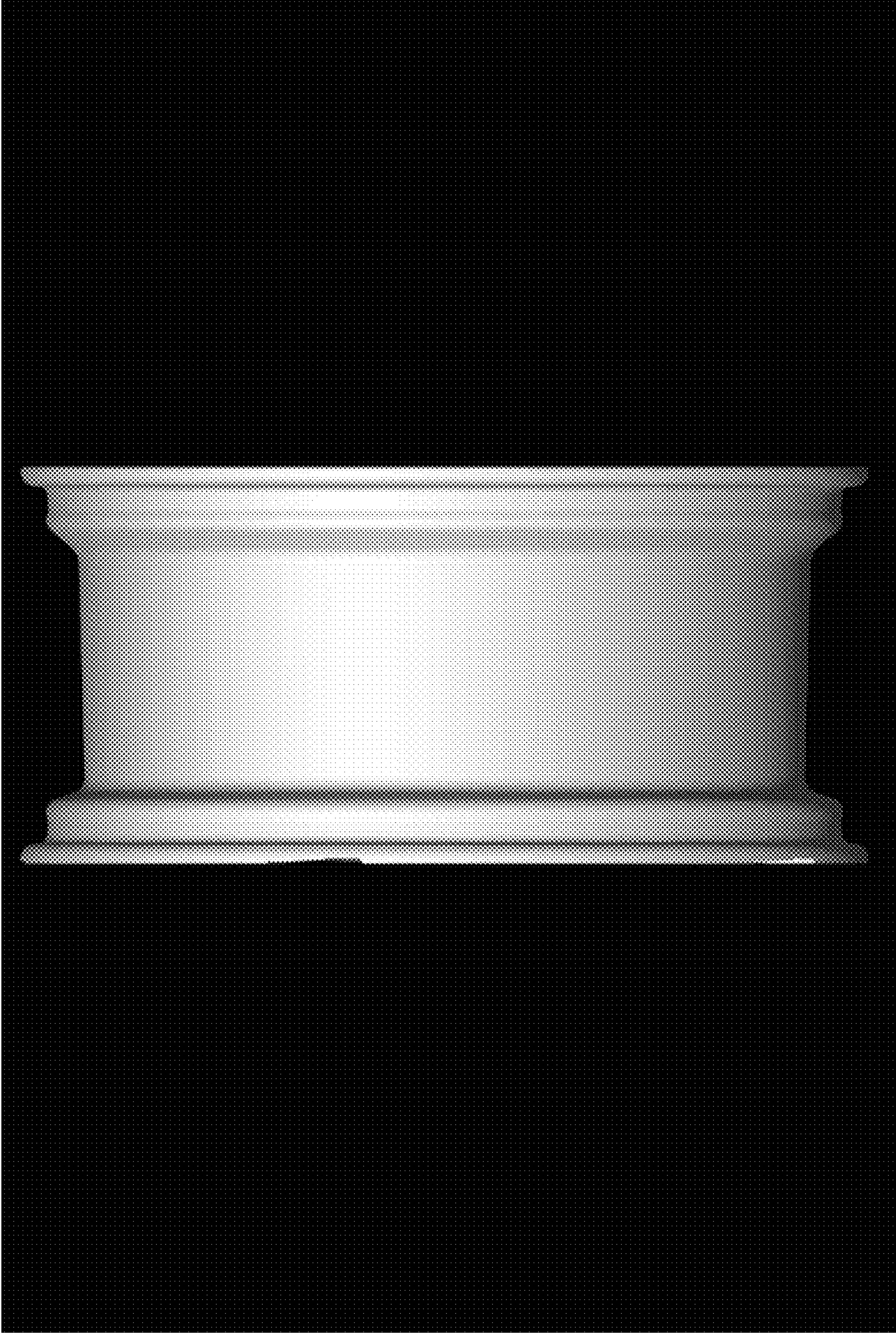

FIG.13

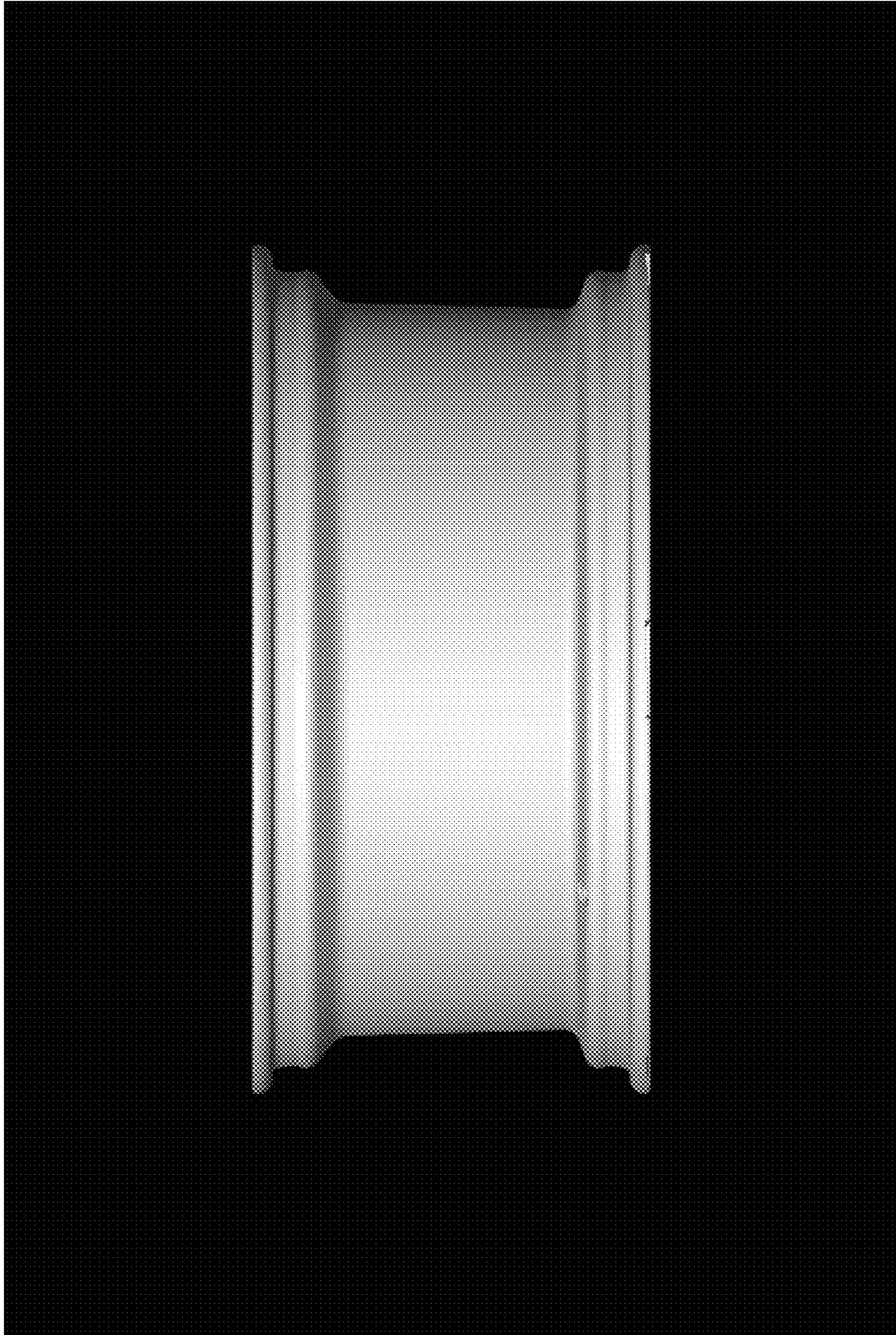

FIG.14

