



US00D931575S

(12) **United States Design Patent** (10) **Patent No.:** **US D931,575 S**
Rodriguez et al. (45) **Date of Patent:** **** Sep. 28, 2021**

(54) **PAIR OF PANTS WITH ZIPPER AND DRAWSTRINGS**

(71) Applicants: **Yana Rodriguez**, San Jose, CA (US); **Vladimir Sukhanov**, San Jose, CA (US); **Joseph Weintz**, Campbell, CA (US)

(72) Inventors: **Yana Rodriguez**, San Jose, CA (US); **Vladimir Sukhanov**, San Jose, CA (US); **Joseph Weintz**, Campbell, CA (US)

(**) Term: **15 Years**

(21) Appl. No.: **29/719,053**

(22) Filed: **Dec. 31, 2019**

(51) **LOC (13) Cl.** **02-02**

(52) **U.S. Cl.**
USPC **D2/742; D2/853**

(58) **Field of Classification Search**
USPC **D2/742, 731, 728, 853**
CPC **A41D 1/06; A44B 11/10; A44B 19/00; A44B 1/18**
See application file for complete search history.

(56) **References Cited**

U.S. PATENT DOCUMENTS

D481,196 S *	10/2003	Rocha	D2/742
D506,303 S *	6/2005	Rocha	2/69
D619,332 S *	7/2010	Pouches	D2/742
D710,069 S *	8/2014	Grotto	D2/742
D756,071 S *	5/2016	Onderick	D2/853
D782,159 S *	3/2017	Pollitt	D2/742
D822,949 S *	7/2018	Emanuel	D2/742
D839,541 S *	2/2019	Pollitt	D2/742
D877,458 S *	3/2020	Pollitt	D2/742
D915,741 S *	4/2021	Gonzalez	D2/853
2014/0157490 A1 *	6/2014	Moran	A41D 1/06 2/236

(Continued)

OTHER PUBLICATIONS

FASKUNOIE Men's 3/4 Linen Cotton Shorts, posted Jun. 22, 2018 [online], (retrieved Jun. 1, 2021). Retrieved from the internet, https://www.amazon.com/dp/B07DXFWQMB/ref=sspa_dk_detail_3?psc=1&pd_rd_i=B07DXFWQMB&pd_rd_w=HoCAm&pf_rd_p=91afecf5-8b2e-41e%E2%80%A6 (Year: 2018).*

Primary Examiner — Kevin K Rudzinski
Assistant Examiner — J. Thorn, Sr.

(57) **CLAIM**

The ornamental design for a pair of pants with zipper and drawstrings, as shown and described.

DESCRIPTION

FIG. 1 is a front-top perspective view of a pair of pants with zipper and drawstrings showing my new design; FIG. 2 is a front-bottom perspective view thereof; FIG. 3 is a rear-top perspective view thereof; FIG. 4 is a rear elevational view thereof; FIG. 5 is a front elevational view thereof; FIG. 6 is a top plan view thereof; FIG. 7 is a bottom plan view thereof; FIG. 8 is a left elevational view thereof; FIG. 9 is a right elevational view thereof; FIG. 10 is a magnified view taken about box 10 in FIG. 5; FIG. 11 is a magnified view taken about box 11 in FIG. 4; FIG. 12 is a magnified view taken about box 12 in FIG. 7; FIG. 13 is a magnified view taken about box 13 in FIG. 1; FIG. 14 is a magnified view taken about box 14 in FIG. 2; and, FIG. 15 is a magnified view taken about box 15 in FIG. 3. The broken lines in the drawings depict portions of the pair of pants with zipper and drawstrings that form no part of the claimed design.

1 Claim, 15 Drawing Sheets

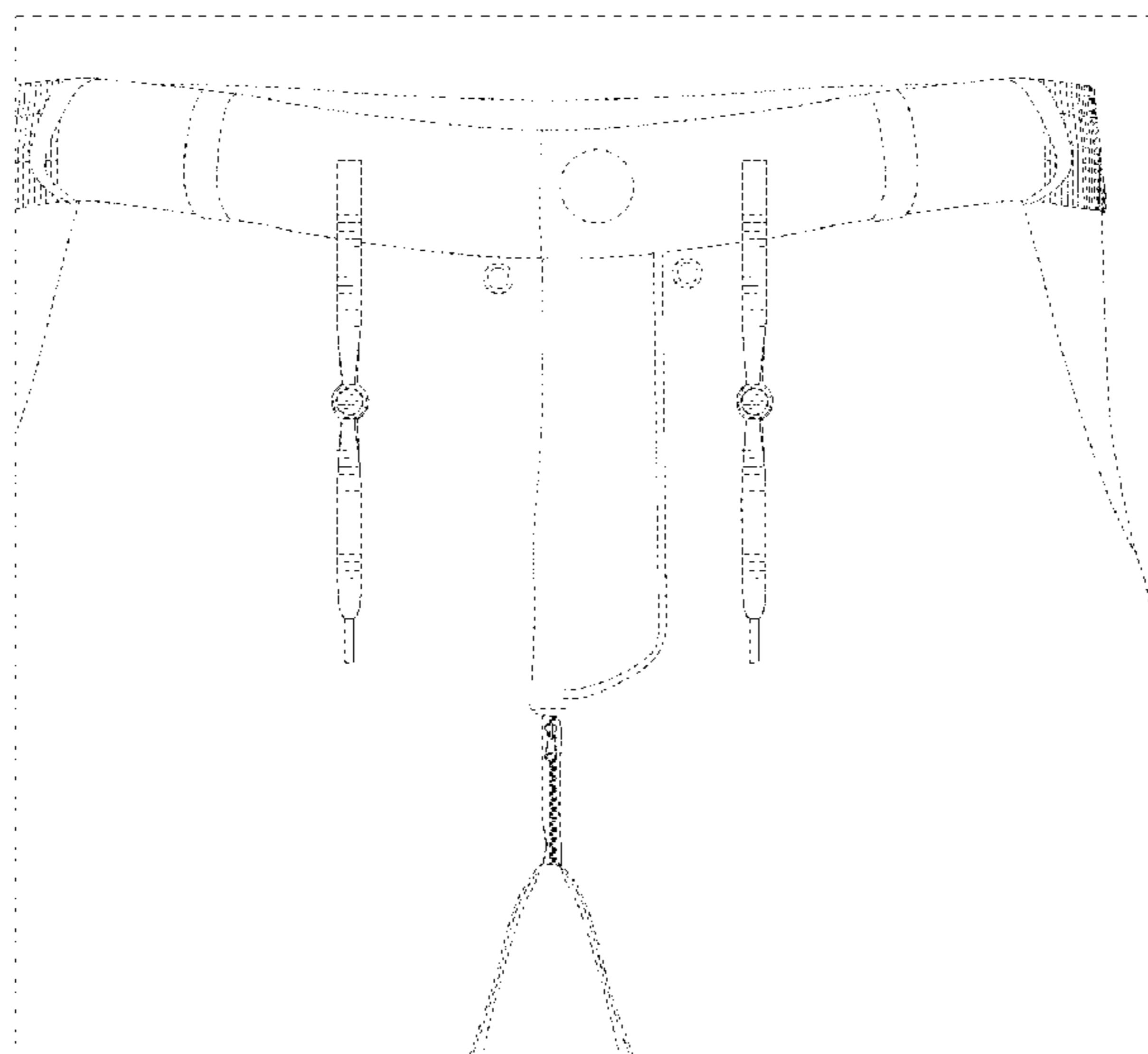

(56)

References Cited

U.S. PATENT DOCUMENTS

2015/0201685 A1* 7/2015 Brohmer A41D 13/065
2/23
2019/0029344 A1* 1/2019 Moore A41F 9/025
2021/0037896 A1* 2/2021 Mercer A41B 9/005

* cited by examiner

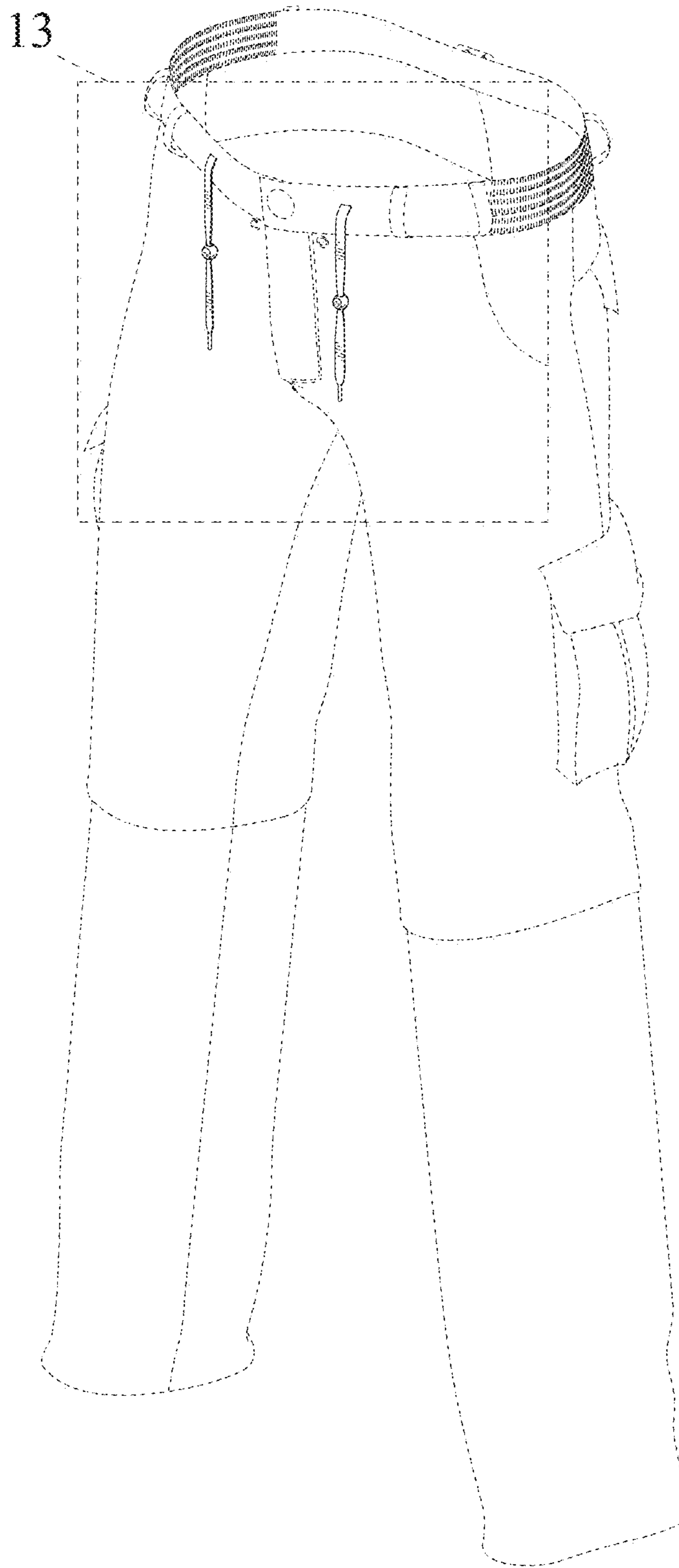

FIG. 1

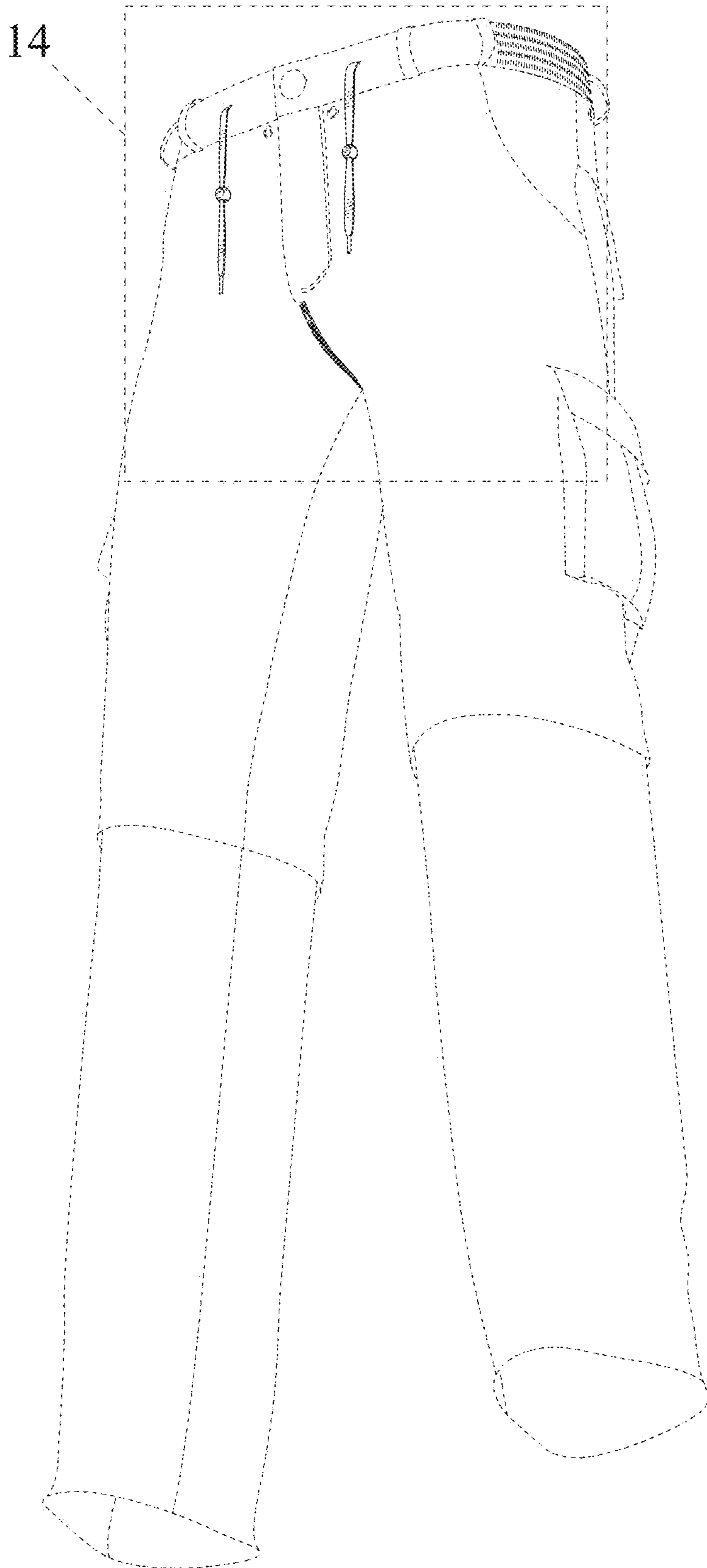

FIG. 2

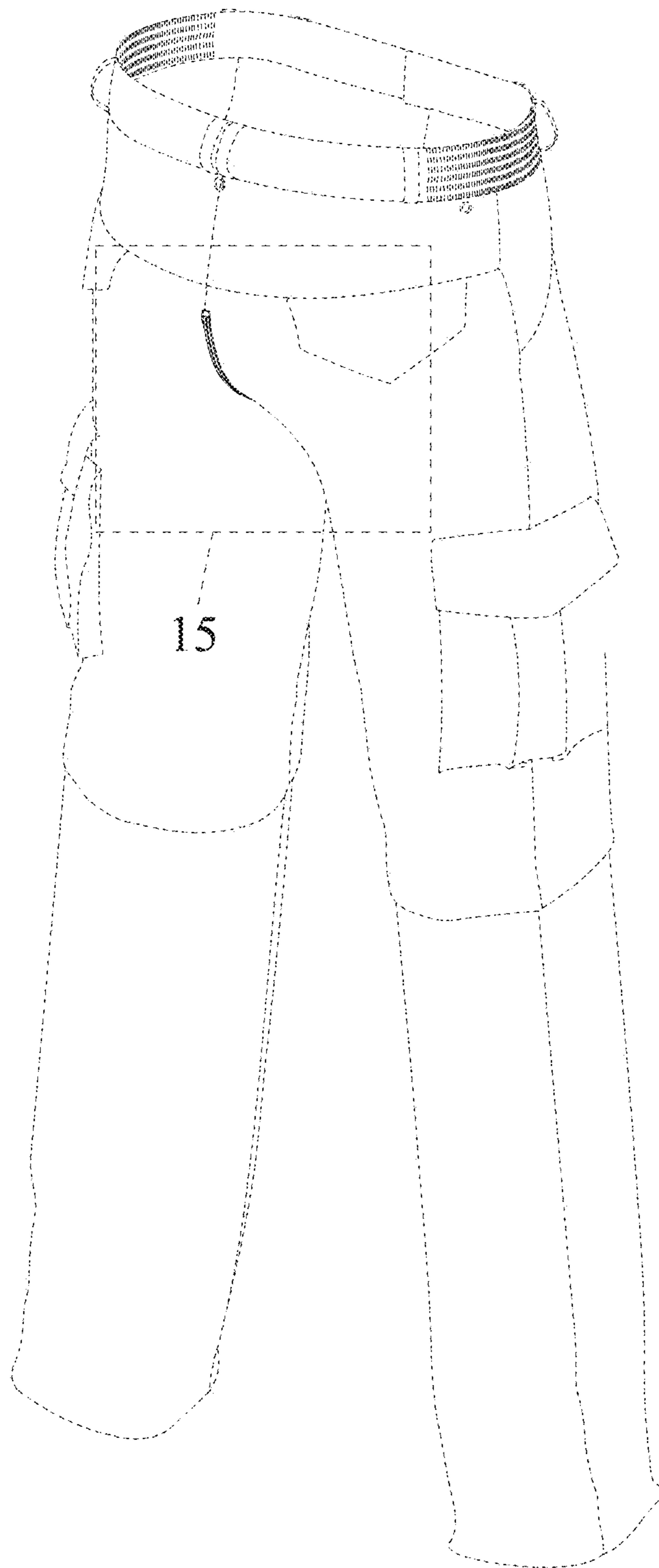

FIG. 3

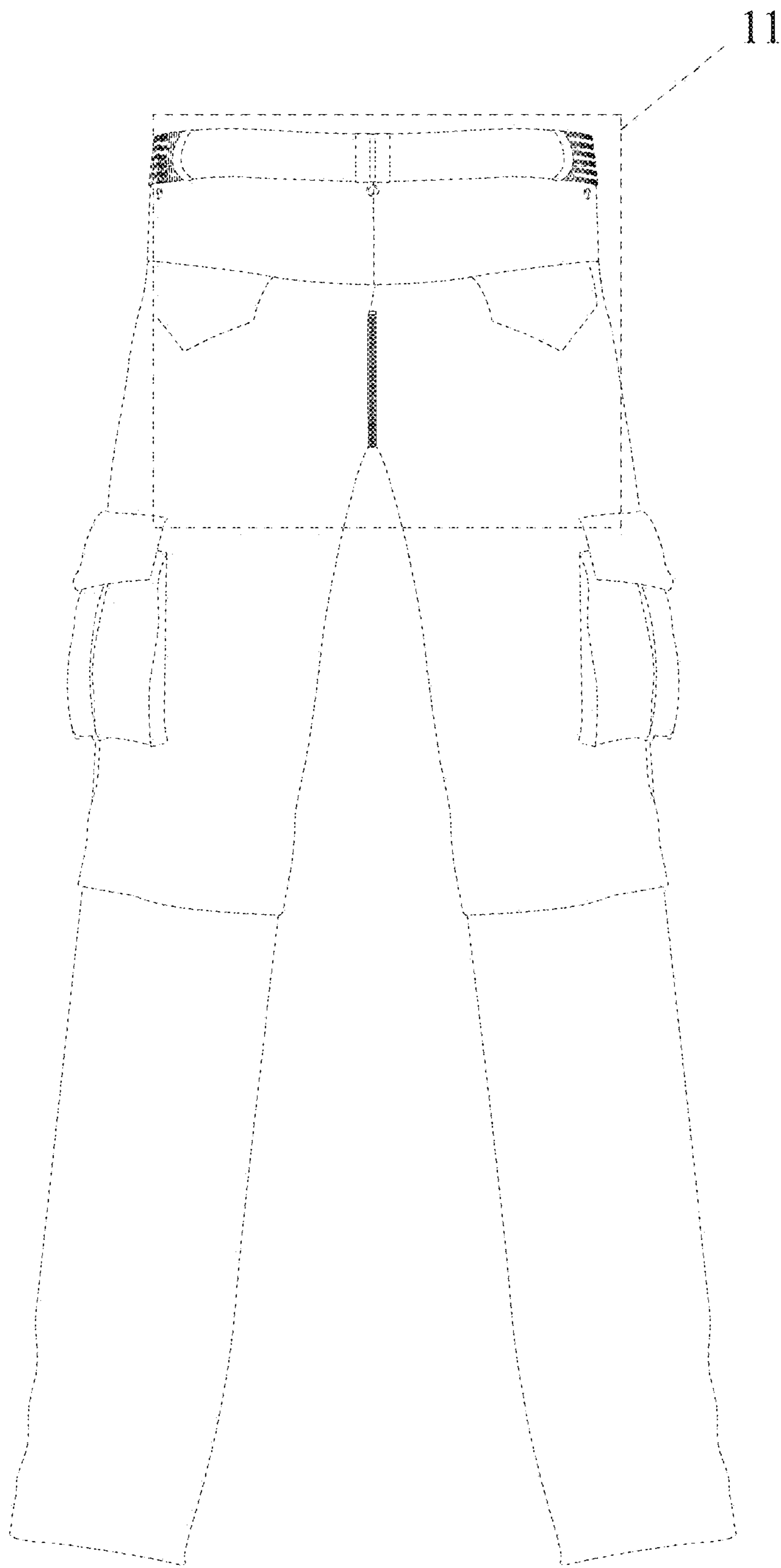

FIG. 4

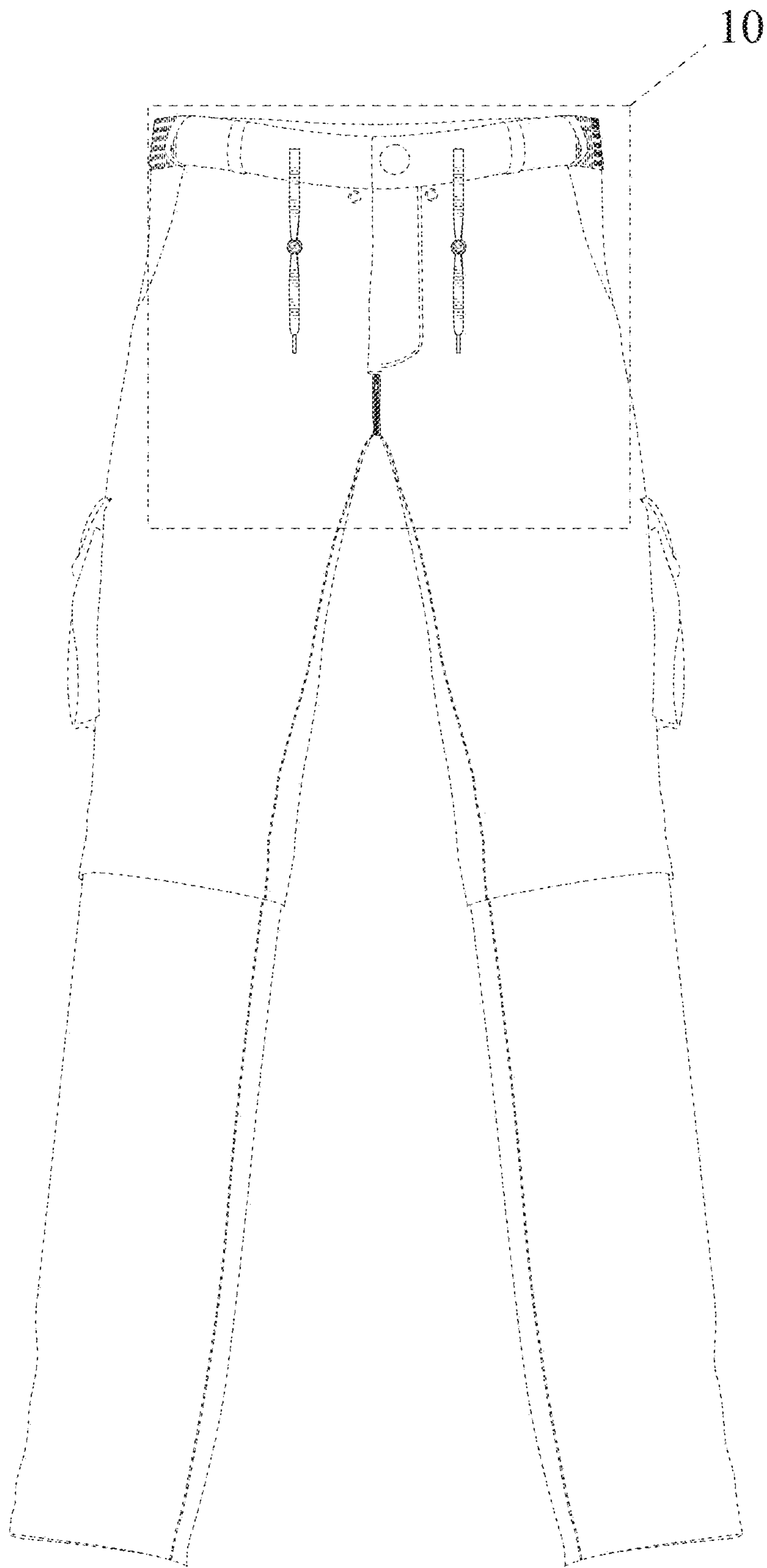

FIG. 5

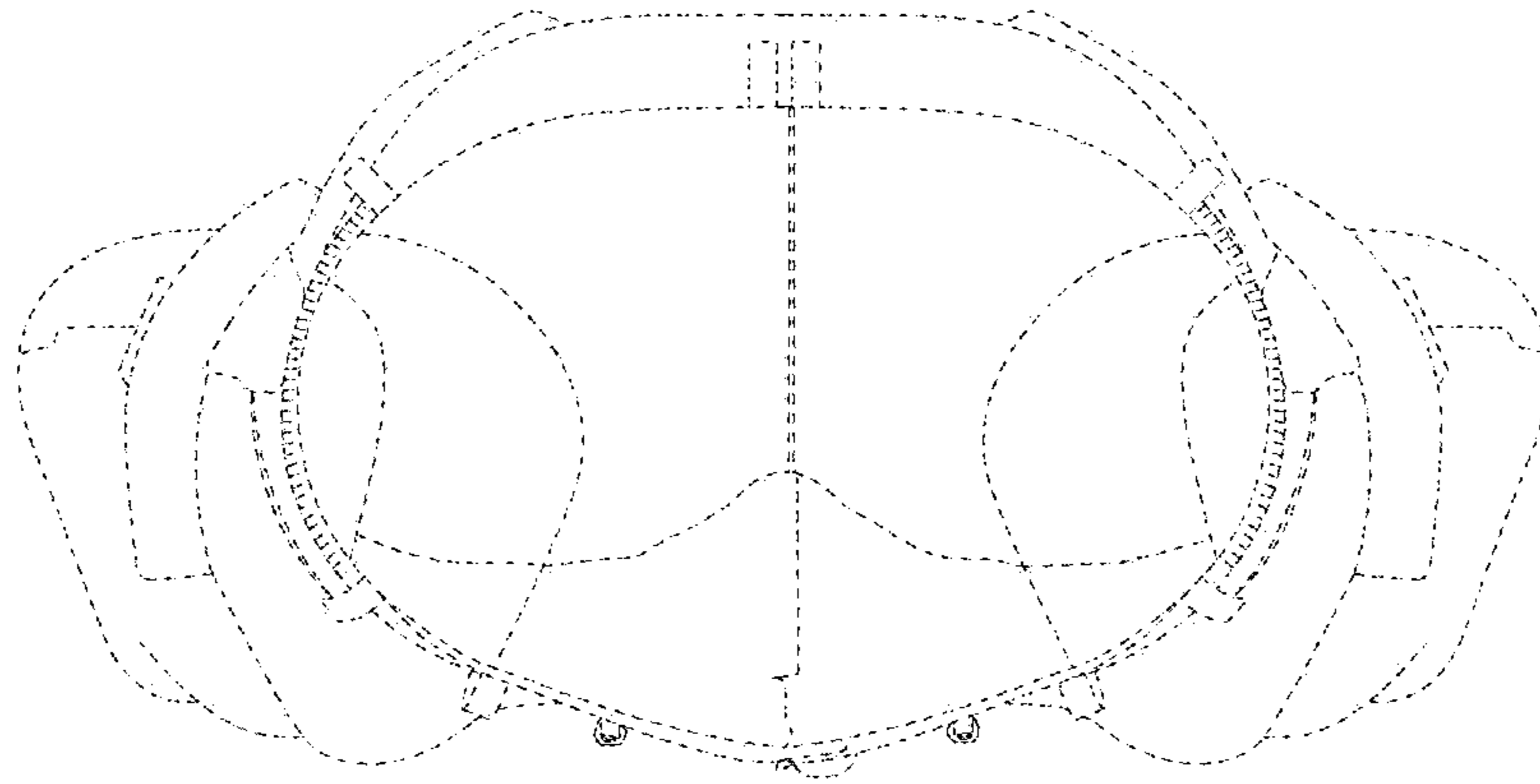

FIG. 6

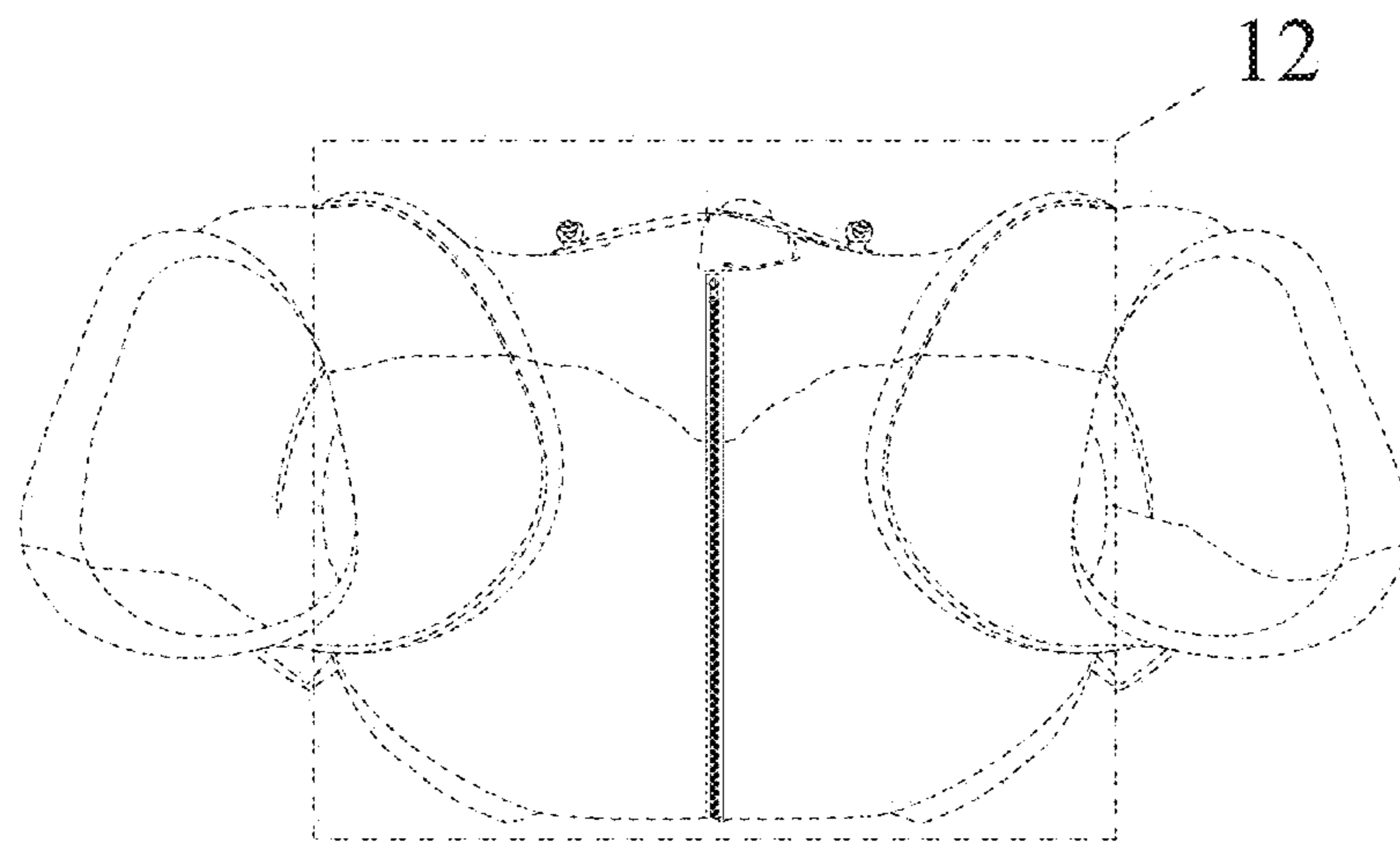

FIG. 7

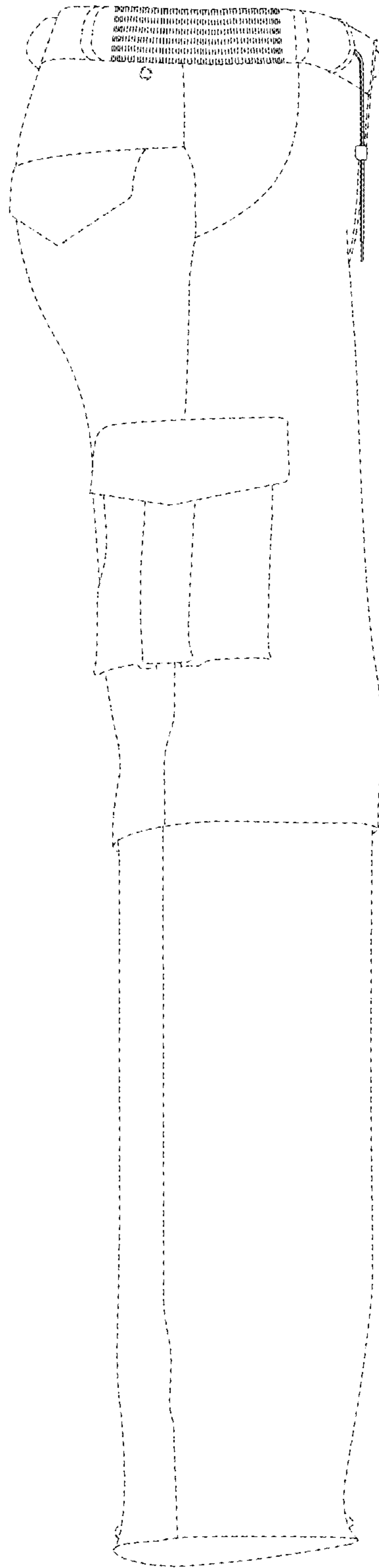

FIG. 8

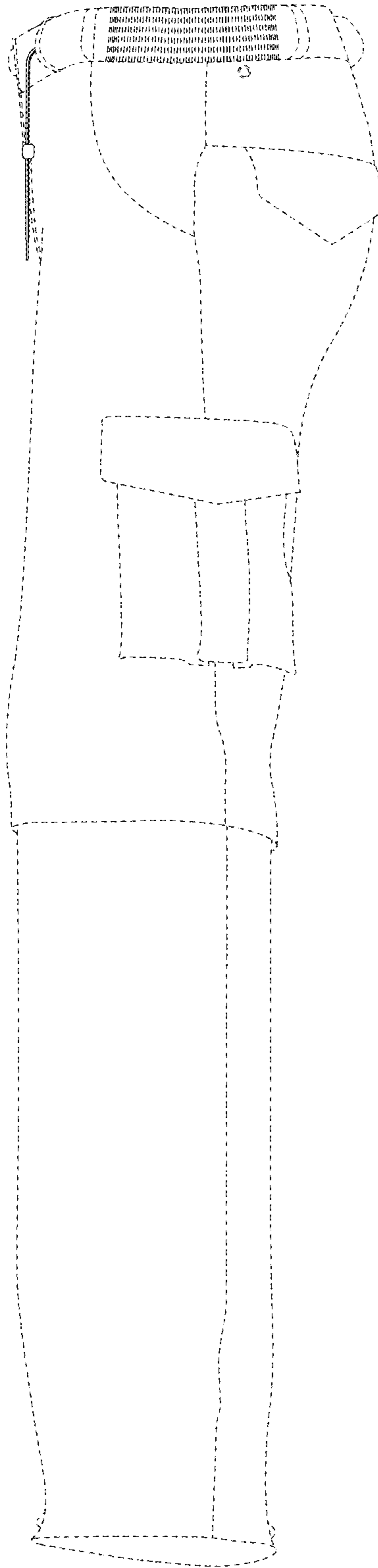

FIG. 9

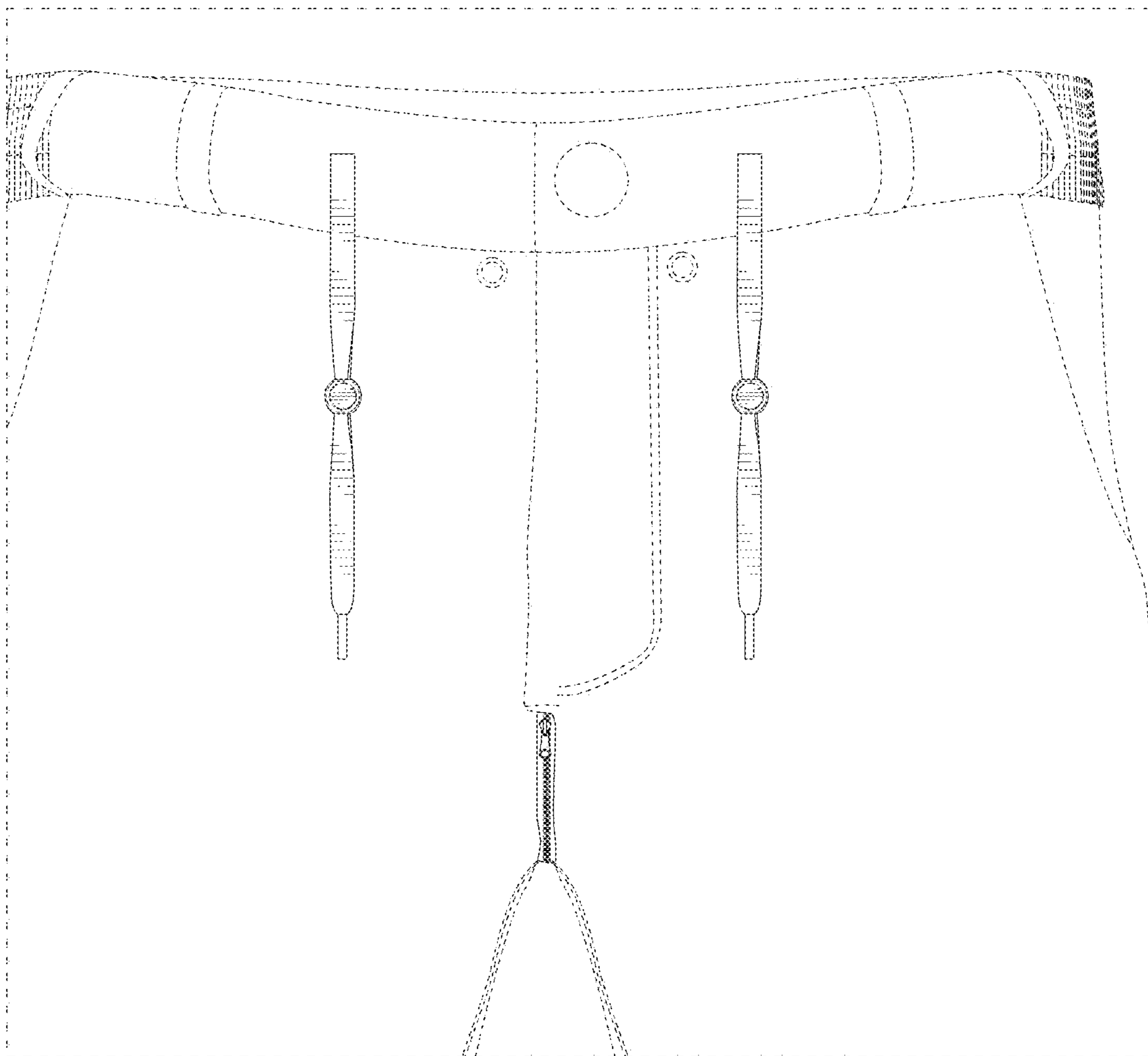

FIG. 10

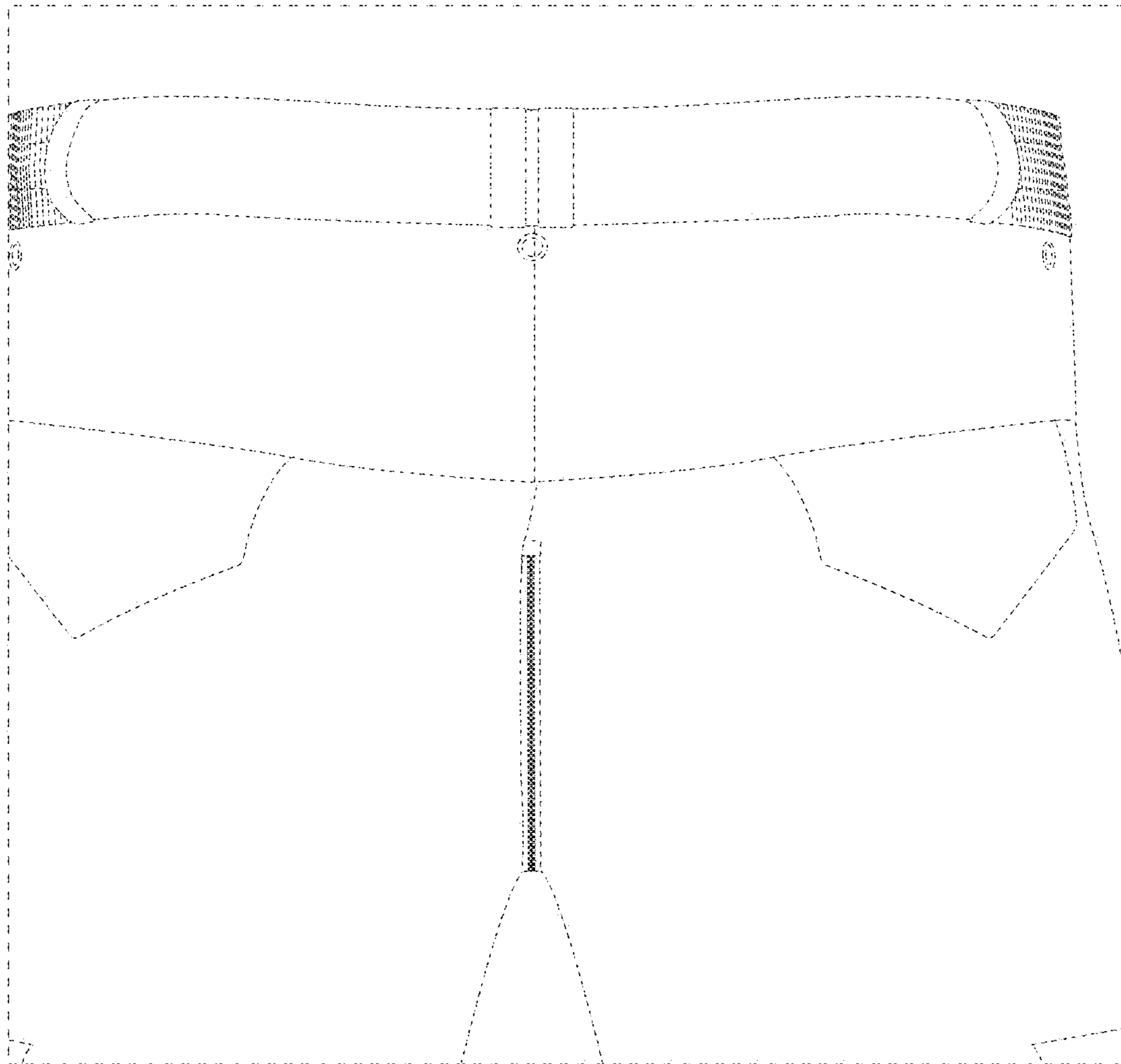

FIG. 11

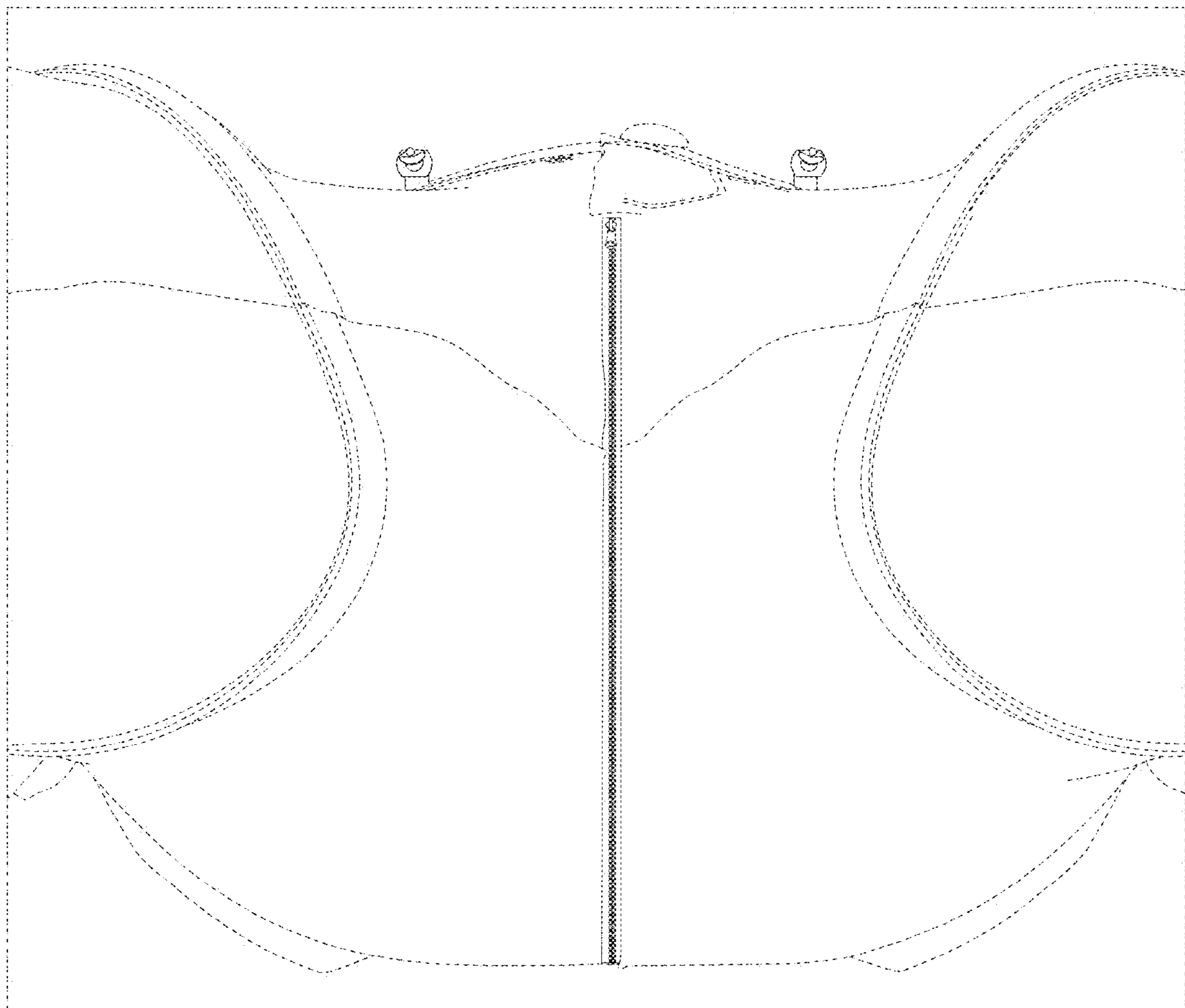

FIG. 12

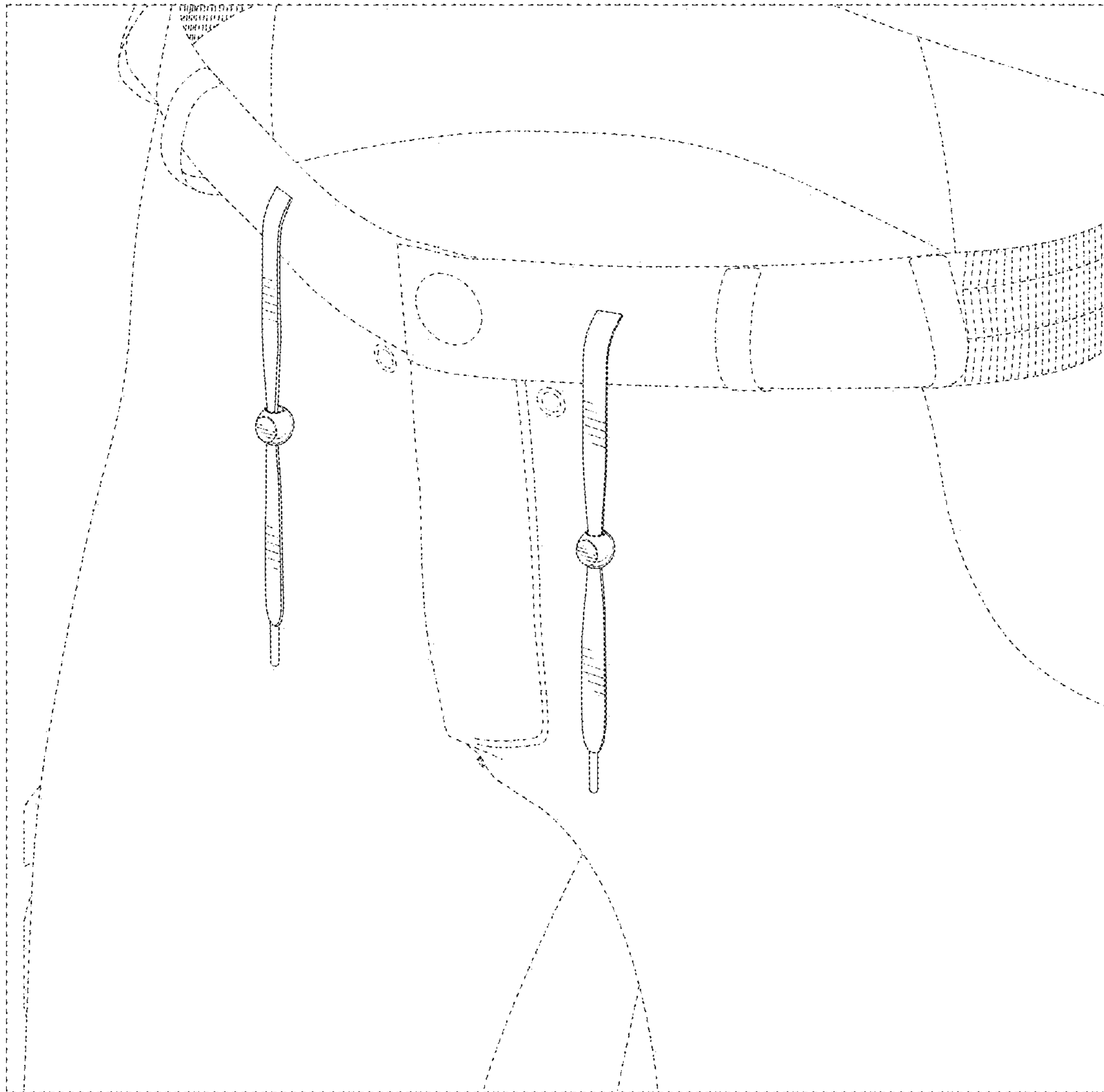

FIG. 13

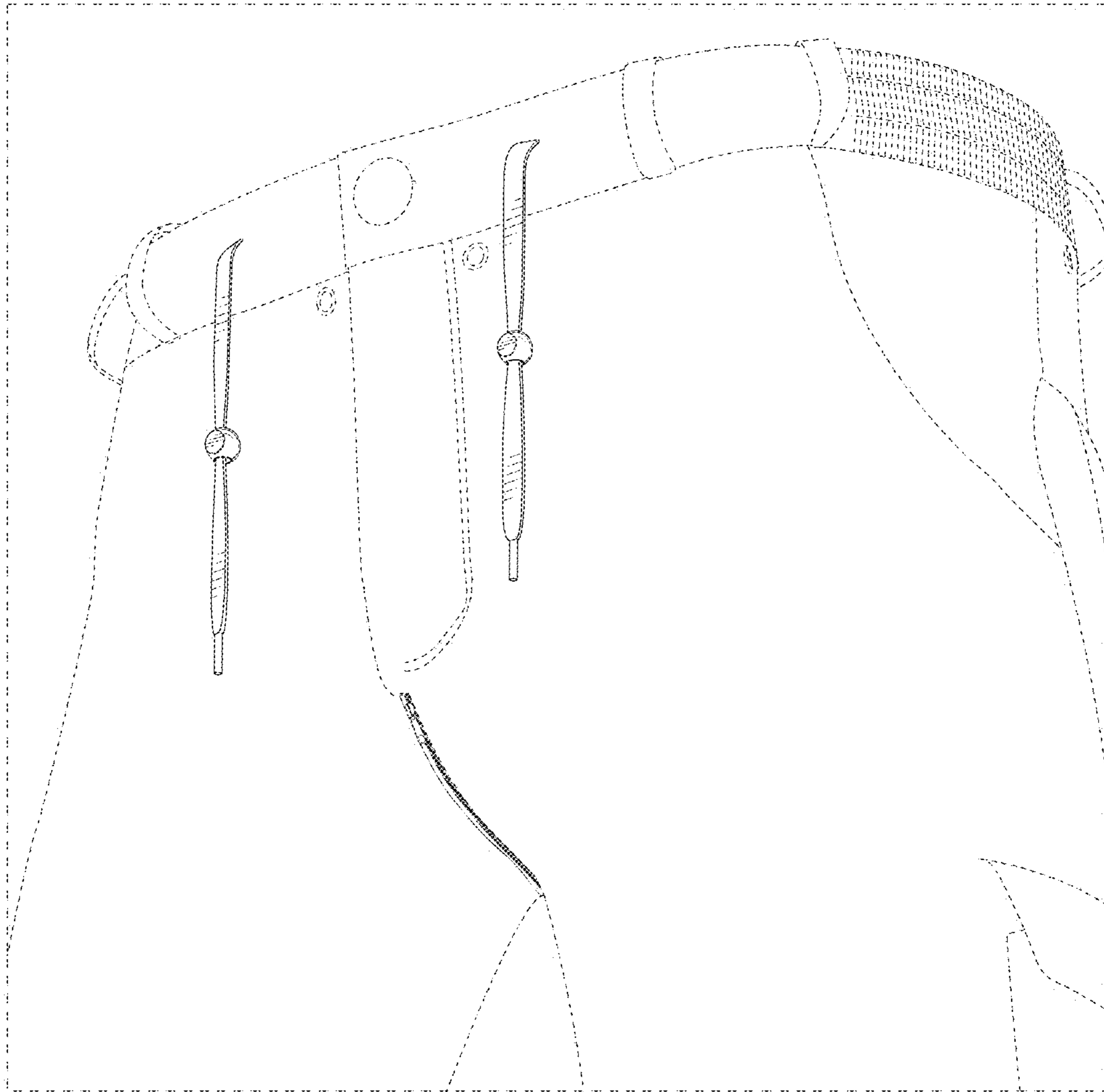

FIG. 14

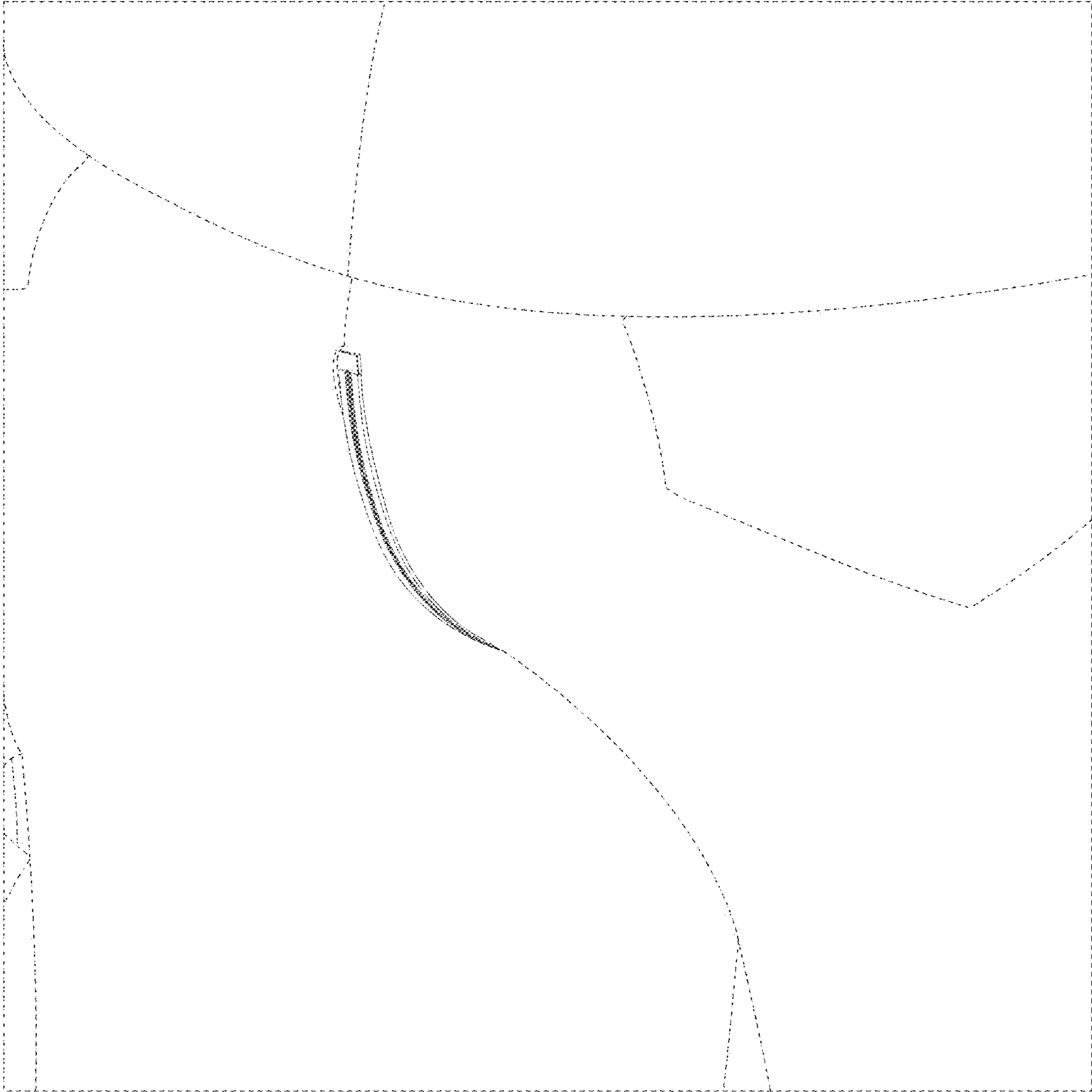

FIG. 15