



US00D931537S

(12) **United States Design Patent** (10) **Patent No.:** **US D931,537 S**  
**Werner** (45) **Date of Patent:** **\*\* Sep. 21, 2021**

(54) **CORDLESS HAIR CLIPPER**

(71) Applicant: **Andis Company**, Sturtevant, WI (US)

(72) Inventor: **Edwin A. Werner**, Union Grove, WI (US)

(73) Assignee: **Andis Company**, Sturtevant, WI (US)

(\*\*) Term: **15 Years**

(21) Appl. No.: **29/689,575**

(22) Filed: **Apr. 30, 2019**

(51) **LOC (13) Cl.** ..... **28-03**

(52) **U.S. Cl.**  
USPC ..... **D28/53**

(58) **Field of Classification Search**  
USPC ..... D28/49-54

(Continued)

(56) **References Cited**

U.S. PATENT DOCUMENTS

3,589,007 A \* 6/1971 Walton ..... B26B 19/28  
30/140

3,659,180 A 4/1972 Urbush  
(Continued)

OTHER PUBLICATIONS

Andis 01557 Professional Master, www.amazon.com, 1 page, reviewed as early as Feb. 2015 (Year: 2015).\*

*Primary Examiner* — Jennifer Rivard

(74) *Attorney, Agent, or Firm* — Reinhart Boerner Van Deuren s.c.

(57) **CLAIM**

I claim the ornamental design for a cordless hair clipper, as shown and described.

**DESCRIPTION**

FIG. 1 is a perspective view from above of an embodiment of the claimed design;

FIG. 2 is a perspective view from below of the claimed design of FIG. 1;

FIG. 3 is a top view of the claimed design of FIG. 1;

FIG. 4 is a bottom view of the claimed design of FIG. 1;

FIG. 5 is a left side view of the claimed design of FIG. 1;

FIG. 6 is a right side view of the claimed design of FIG. 1;

FIG. 7 is a front view of the claimed design of FIG. 1;

FIG. 8 is a rear view of the claimed design of FIG. 1;

FIG. 9 is a perspective view from above of an embodiment of the claimed design;

FIG. 10 is a perspective view from below of the claimed design of FIG. 9;

FIG. 11 is a top view of the claimed design of FIG. 9;

FIG. 12 is a bottom view of the claimed design of FIG. 9;

FIG. 13 is a left side view of the claimed design of FIG. 9;

FIG. 14 is a right side view of the claimed design of FIG. 9;

FIG. 15 is a front view of the claimed design of FIG. 9;

FIG. 16 is a rear view of the claimed design of FIG. 9;

FIG. 17 is a perspective view from above of another embodiment of the claimed design;

FIG. 18 is a perspective view from below of the claimed design of FIG. 17;

FIG. 19 is a top view of the claimed design of FIG. 17;

FIG. 20 is a bottom view of the claimed design of FIG. 17;

FIG. 21 is a left side view of the claimed design of FIG. 17;

FIG. 22 is a right side view of the claimed design of FIG. 17;

FIG. 23 is a front view of the claimed design of FIG. 17;

FIG. 24 is a rear view of the claimed design of FIG. 17;

FIG. 25 is a perspective view from above of a further embodiment of the claimed design;

FIG. 26 is a perspective view from below of the claimed design of FIG. 25;

FIG. 27 is a top view of the claimed design of FIG. 25;

FIG. 28 is a bottom view of the claimed design of FIG. 25;

FIG. 29 is a left side view of the claimed design of FIG. 25;

FIG. 30 is a right side view of the claimed design of FIG. 25;

FIG. 31 is a front view of the claimed design of FIG. 25; and,

FIG. 32 is a rear view of the claimed design of FIG. 25.

The ornamental design which is claimed is shown in solid lines in the drawings. The broken lines in the drawings are for illustrative purposes only and form no part of the claimed design.

**1 Claim, 24 Drawing Sheets**

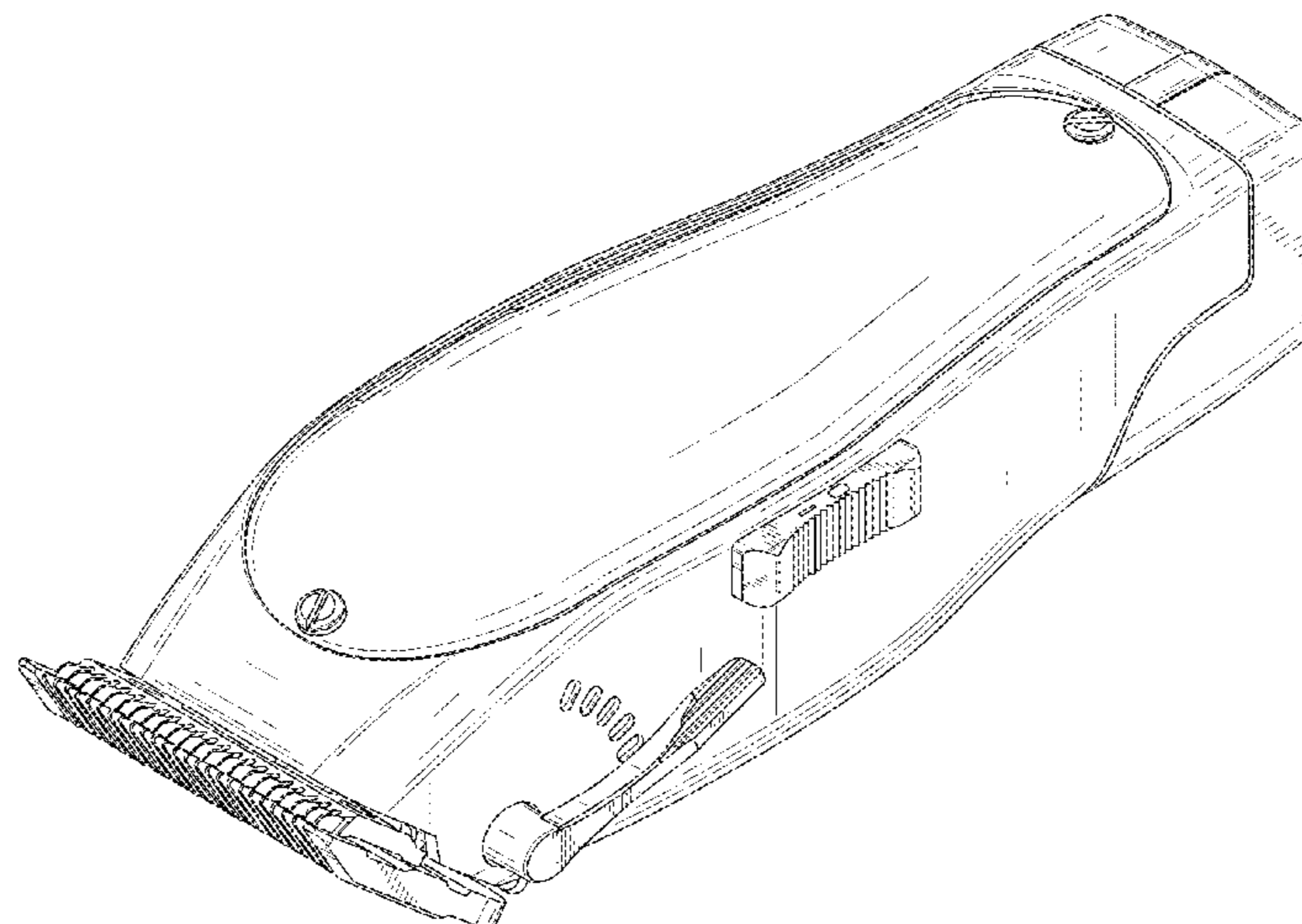

(58) **Field of Classification Search**

CPC ..... B26B 19/00-08; B26B 19/10-12; B26B  
 19/20-24; B26B 19/26-265; B26B  
 19/38-3826; B26B 19/3873-3893; B26B  
 19/42

See application file for complete search history.

(56) **References Cited**

U.S. PATENT DOCUMENTS

6,112,414	A	9/2000	Andis et al.	
D534,689	S *	1/2007	Gross .....	D28/53
D571,504	S *	6/2008	Long .....	D28/54
D715,490	S *	10/2014	Aulwes .....	D28/54
9,038,276	B2 *	5/2015	Arndt .....	B26B 19/06 30/208
D749,786	S *	2/2016	Werner .....	D28/53
D790,133	S *	6/2017	Aulwes .....	D28/54
D821,652	S *	6/2018	Skuhra .....	D28/53
10,059,013	B2 *	8/2018	Skuhra .....	B26B 19/3853
10,137,581	B2	11/2018	Werner	
D844,245	S *	3/2019	Wu .....	D28/53
D846,192	S *	4/2019	Wu .....	D28/53
D847,432	S *	4/2019	Aulwes .....	D28/54
D851,834	S *	6/2019	Peterson, Jr. ....	D28/53
D865,292	S *	10/2019	Peterson, Jr. ....	D28/53
D869,768	S *	12/2019	Cowan .....	D28/53
D898,998	S *	10/2020	Werner .....	D28/53
2003/0051346	A1 *	3/2003	McCambridge ....	B26B 19/3846 30/122
2013/0200823	A1 *	8/2013	Chan .....	H02K 33/16 318/3
2016/0075039	A1 *	3/2016	Werner .....	B26B 19/205 30/201

\* cited by examiner

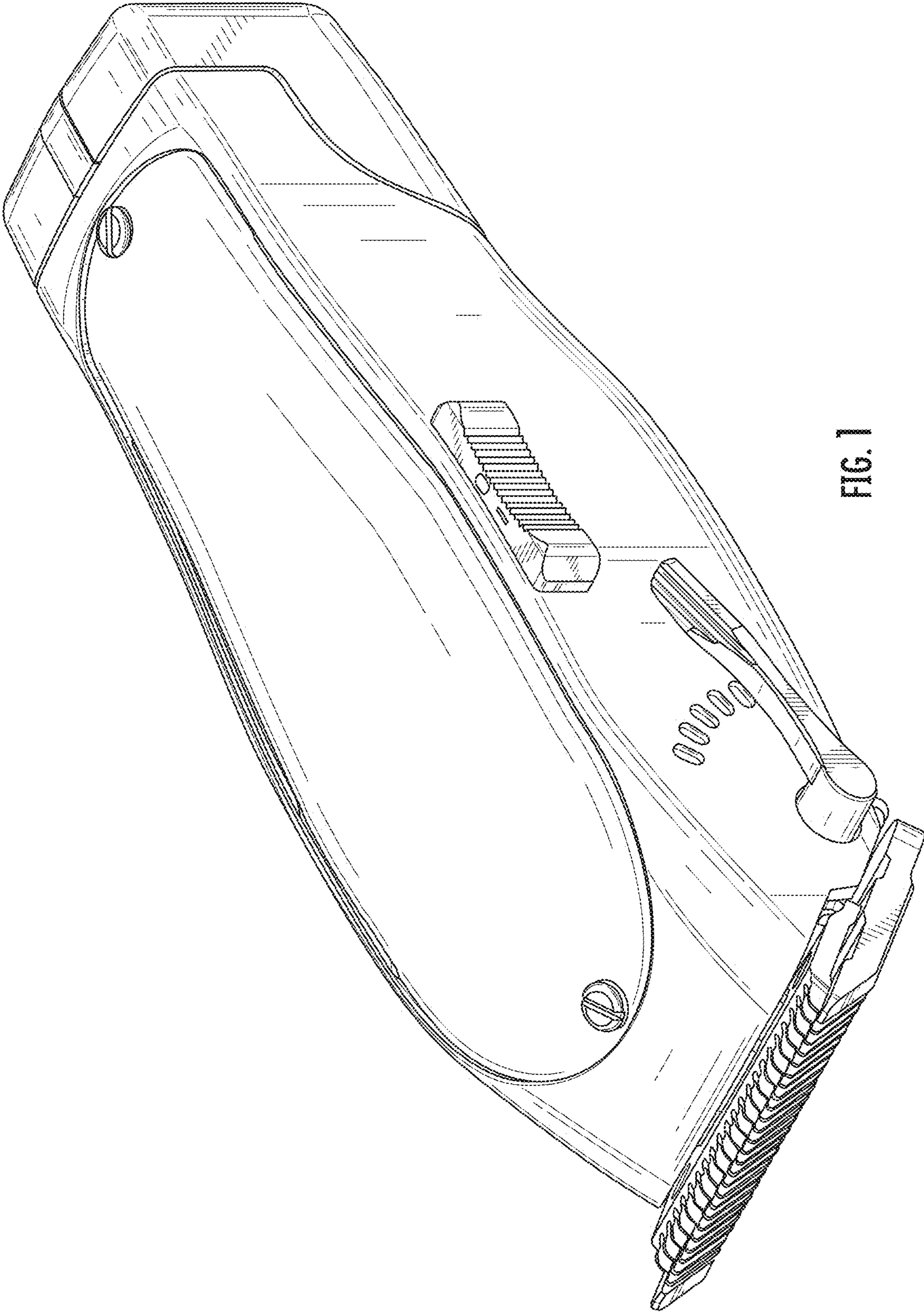

FIG. 1

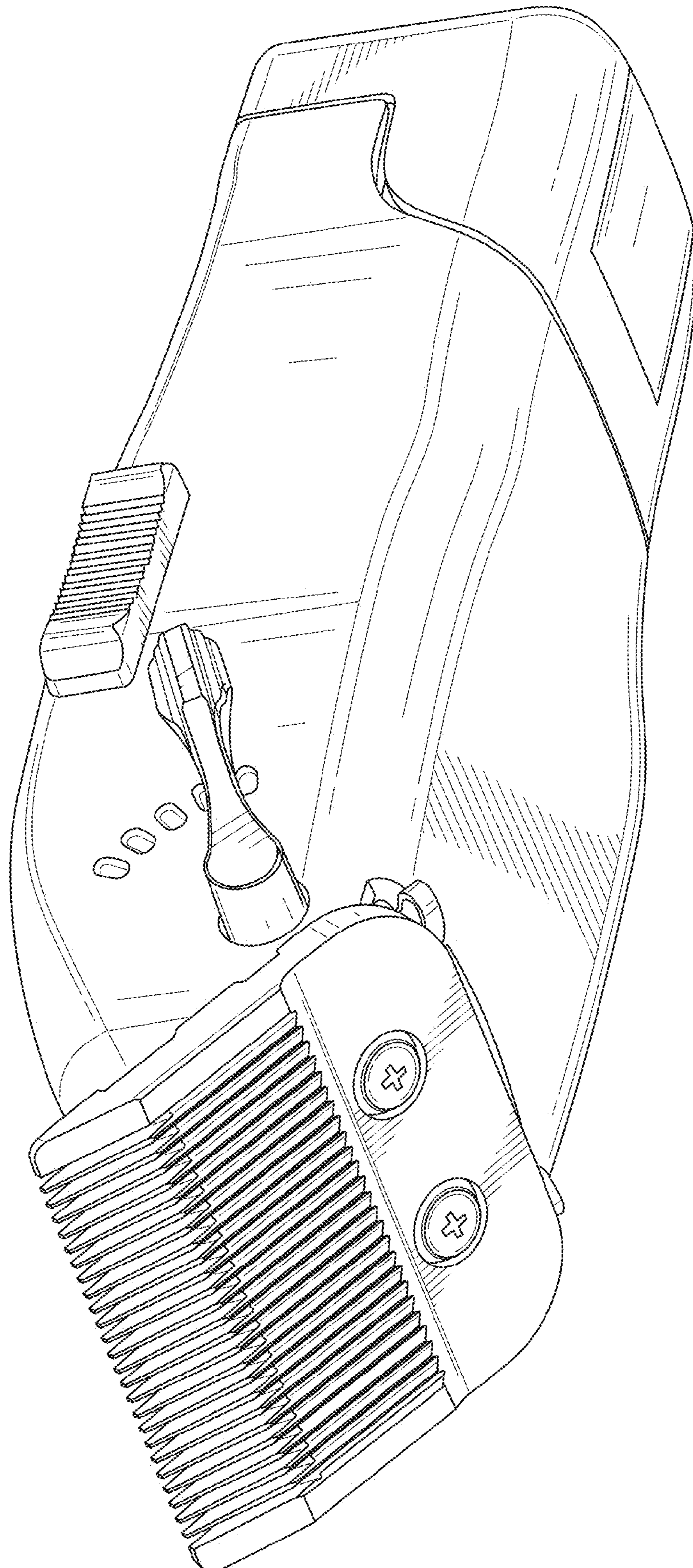

FIG. 2

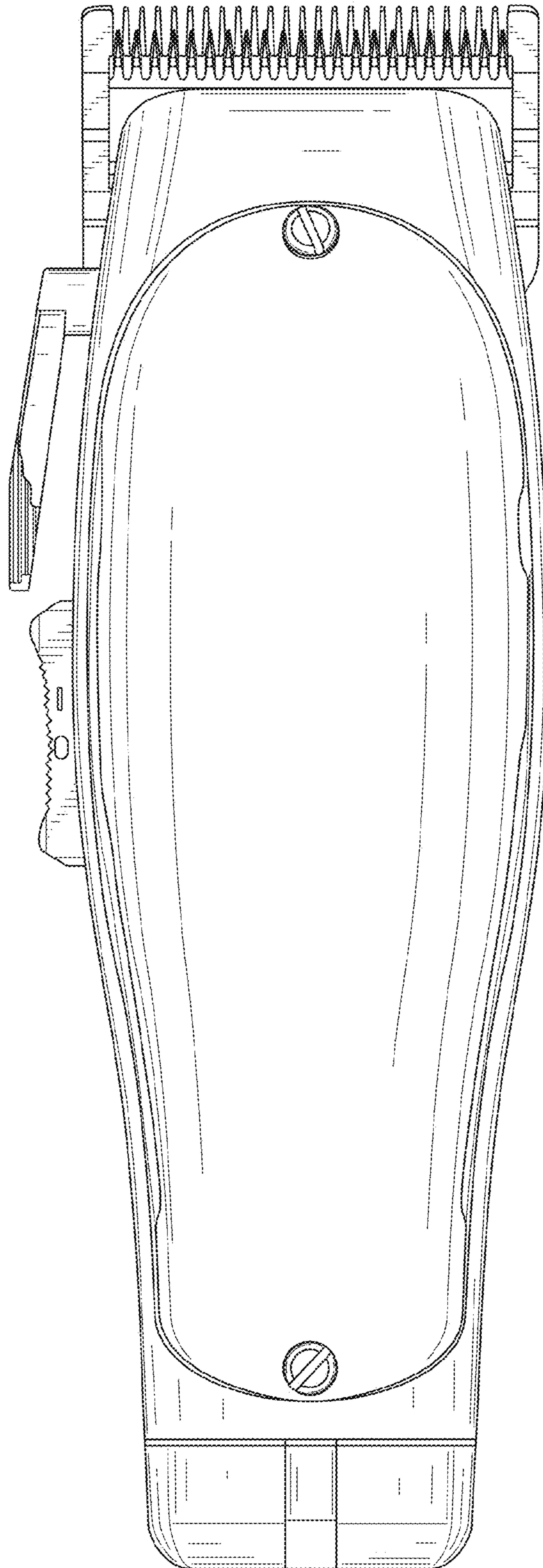

FIG. 3

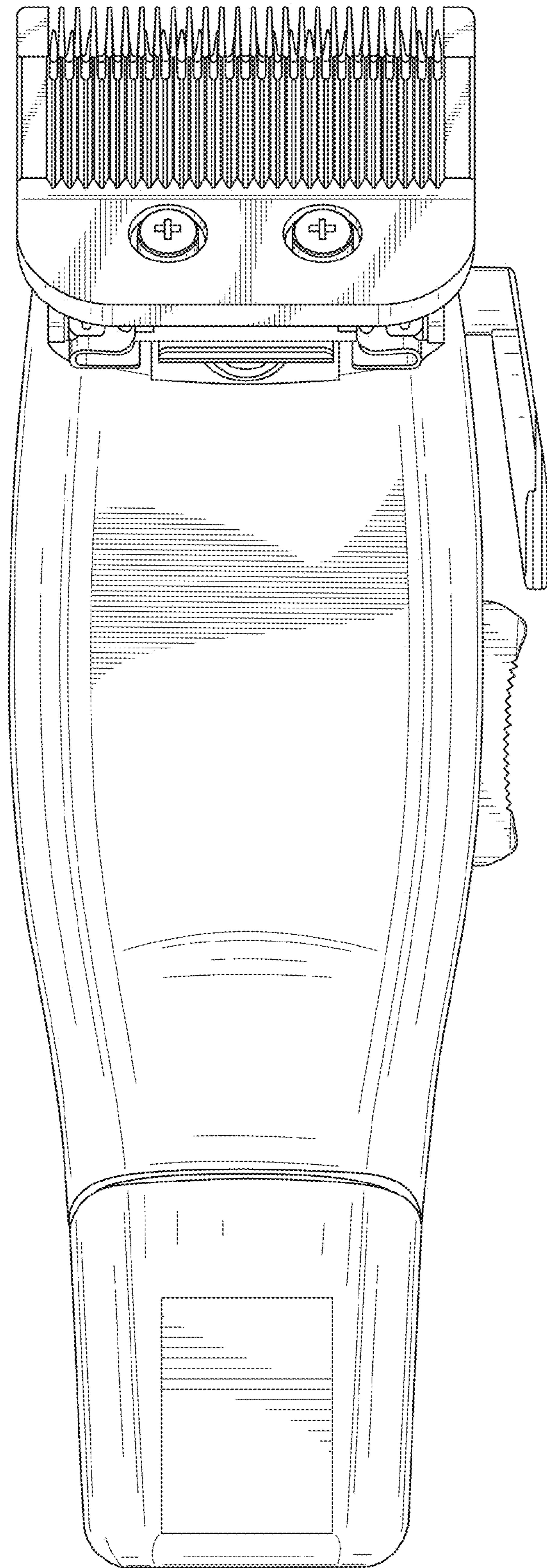

FIG. 4

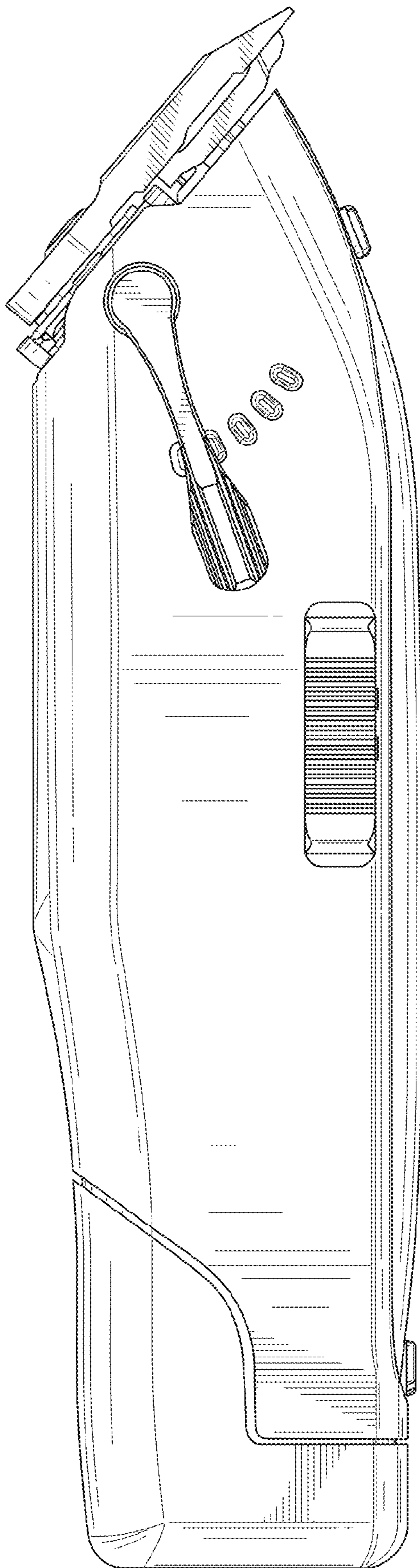

FIG. 5

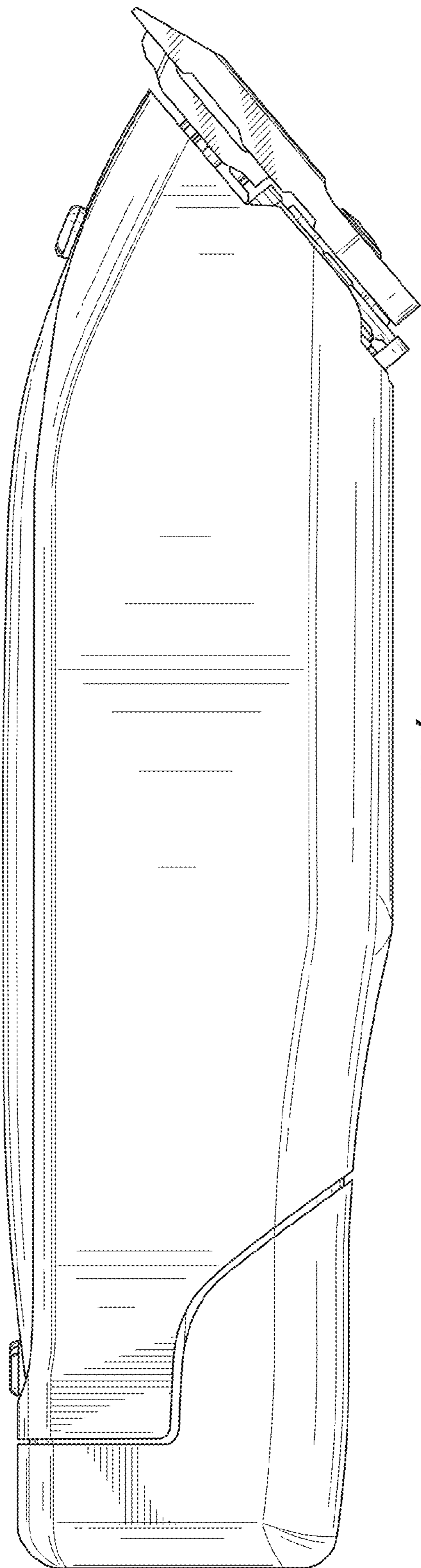

FIG. 6

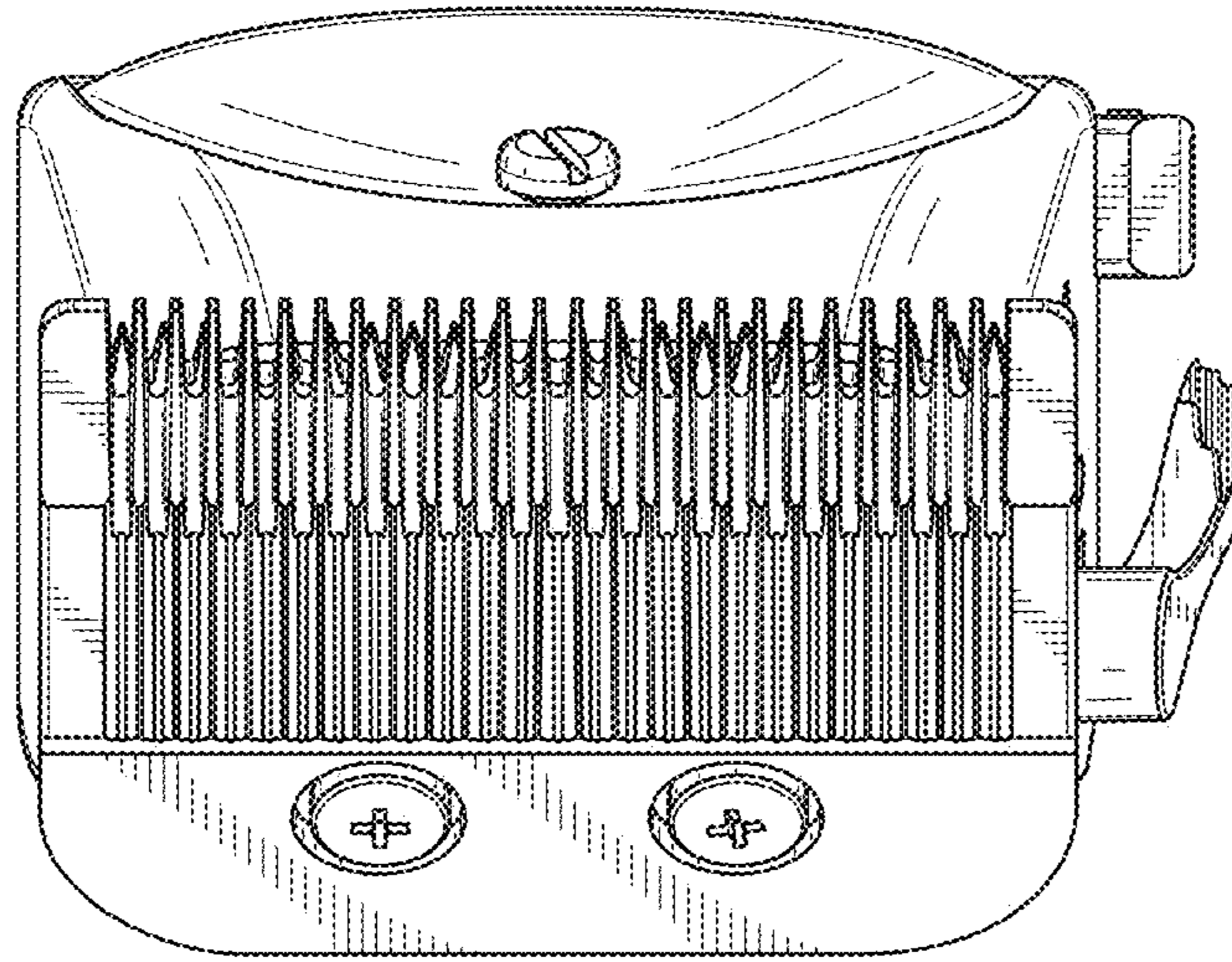

FIG. 7

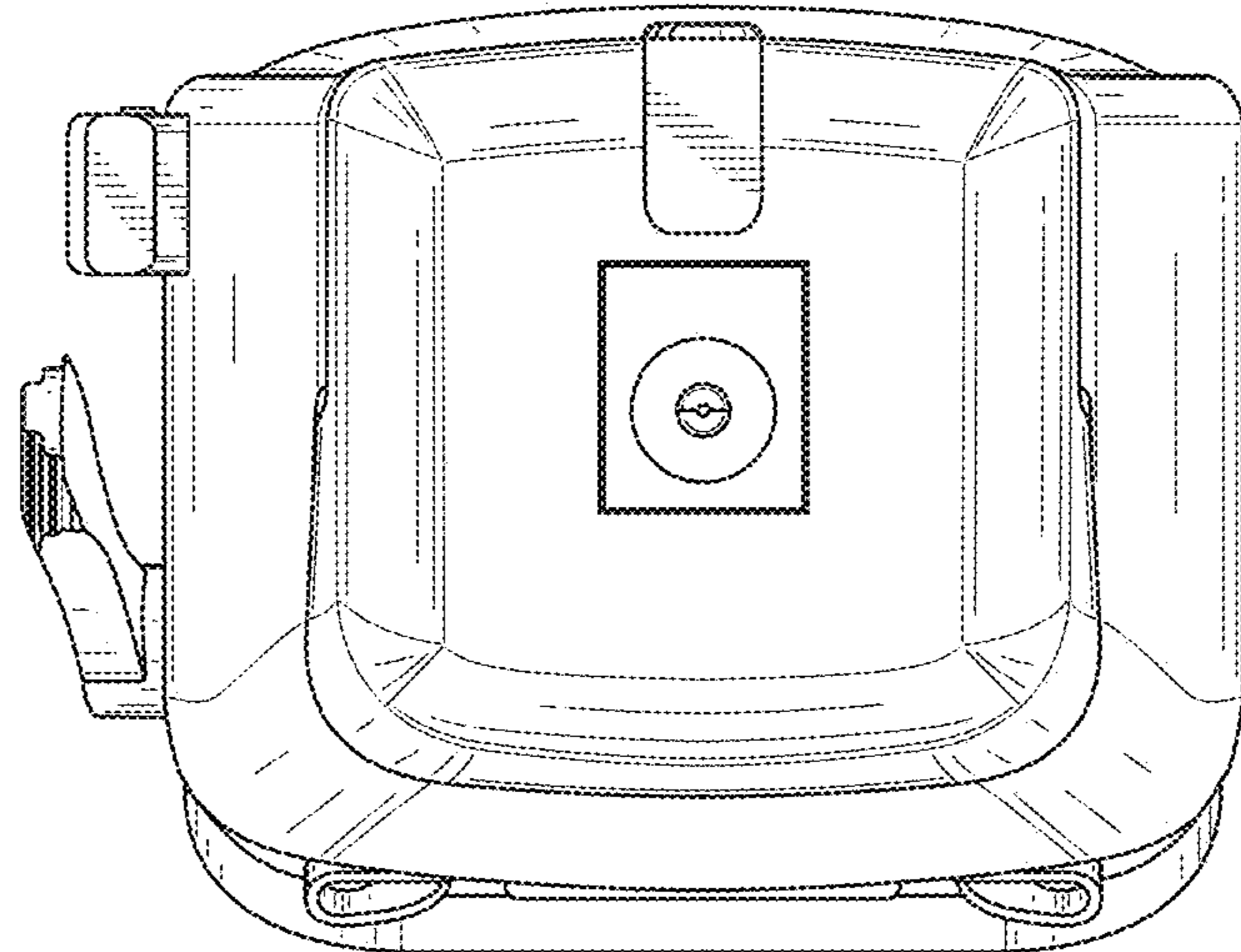

FIG. 8



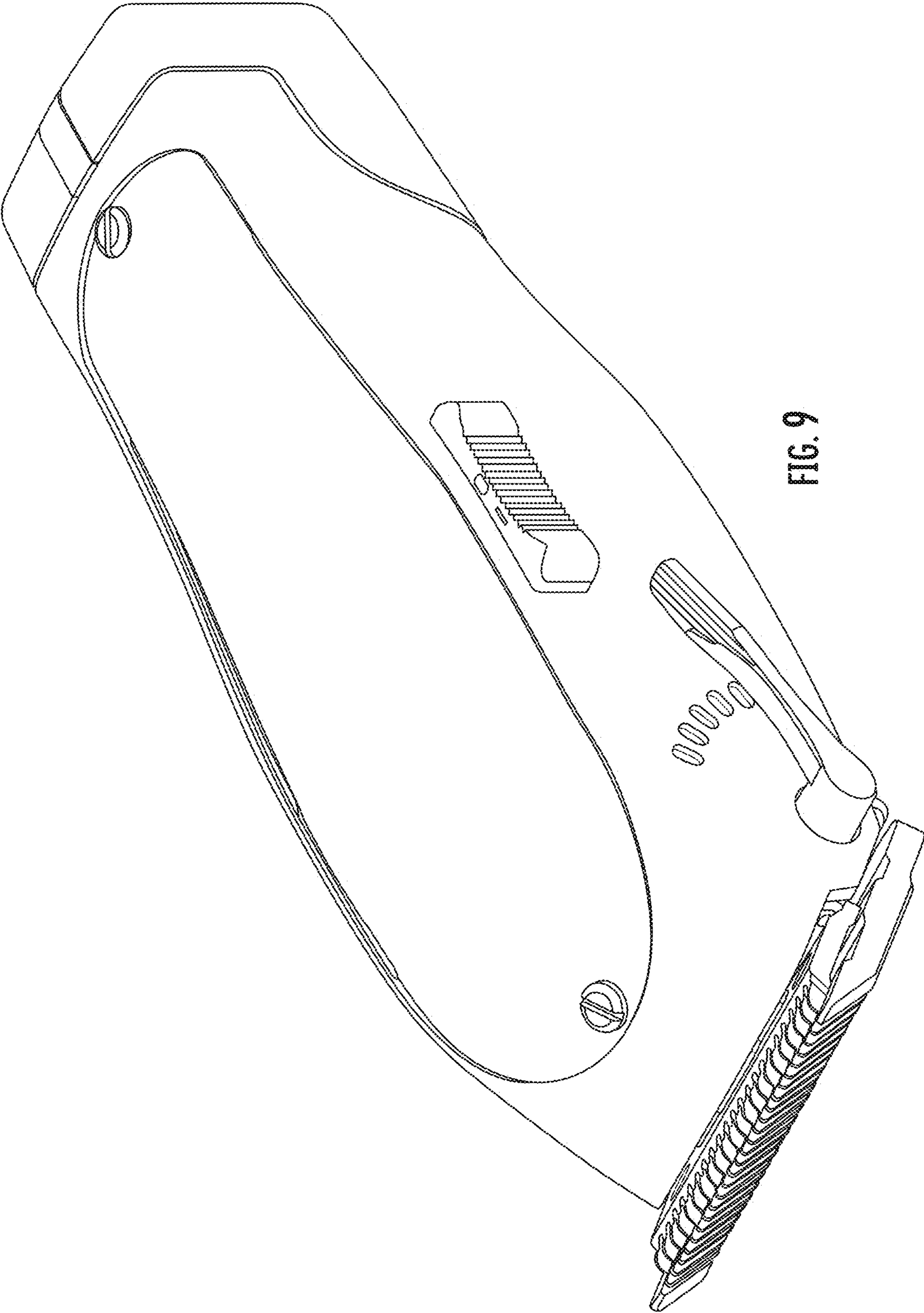

FIG. 9

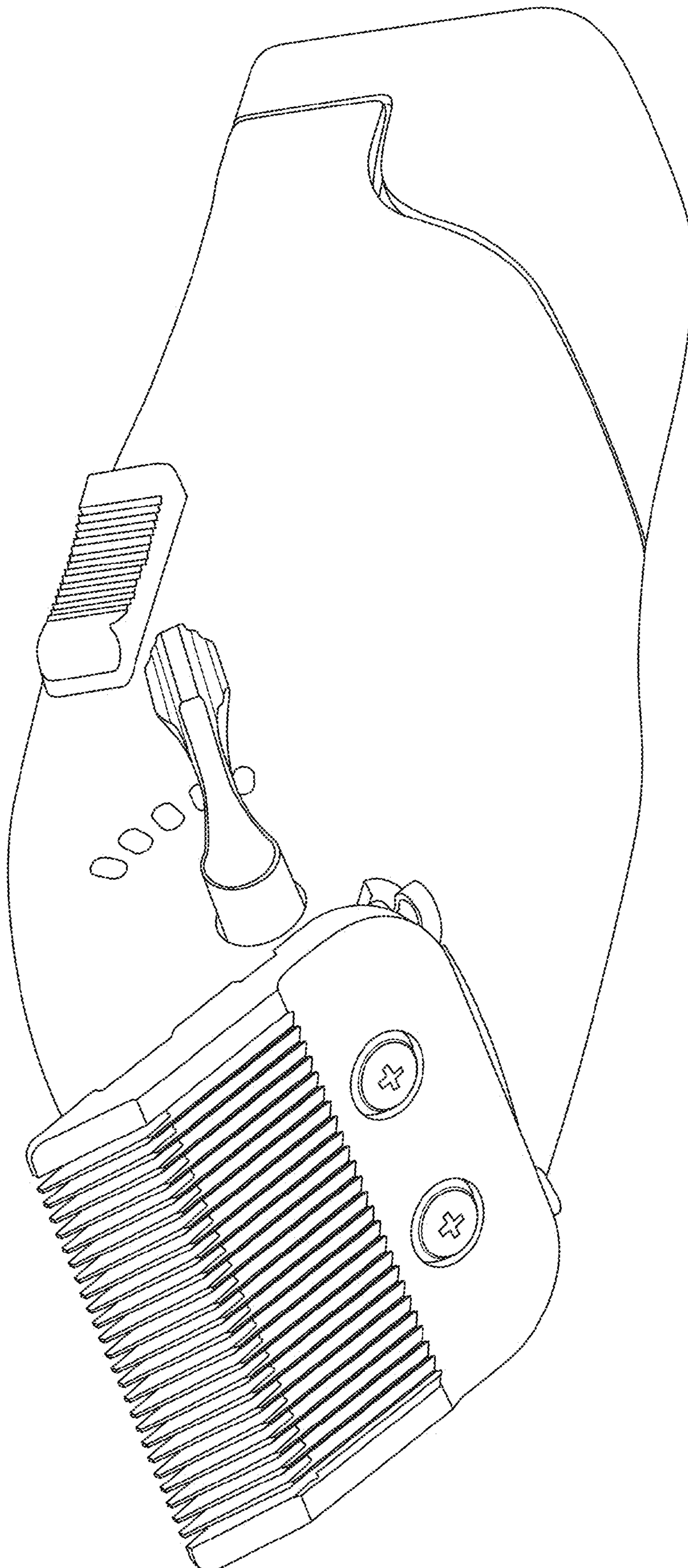

FIG. 10

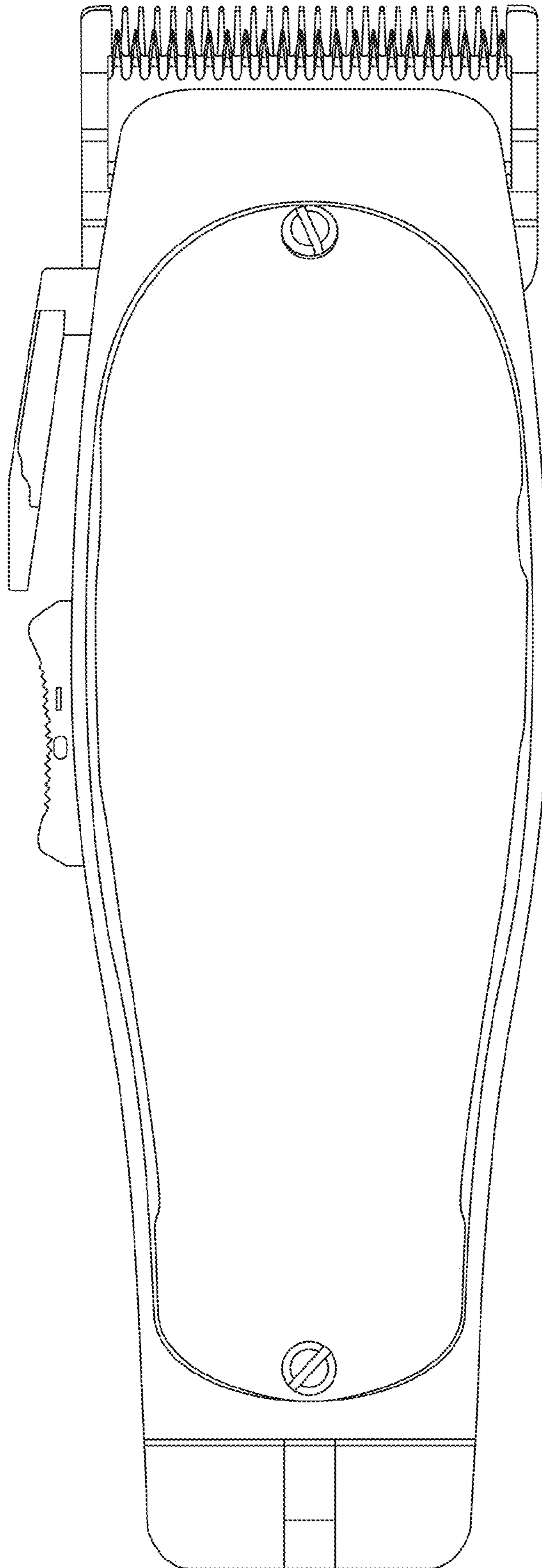

FIG. 11

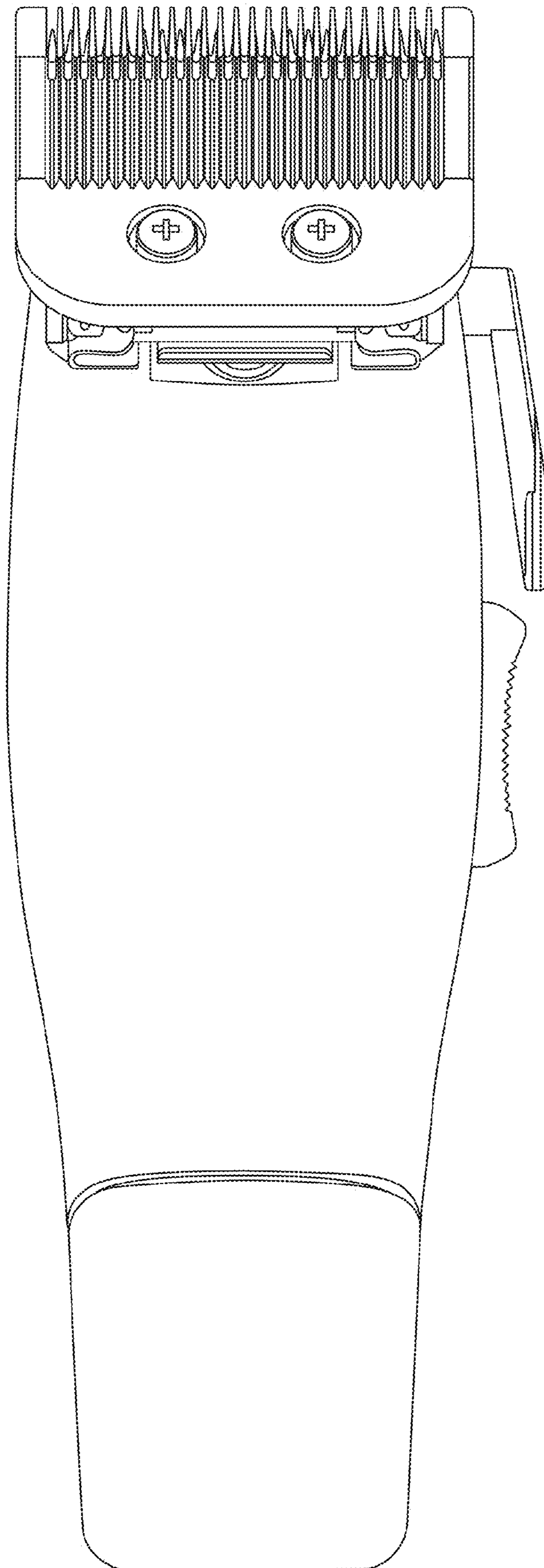

FIG. 12

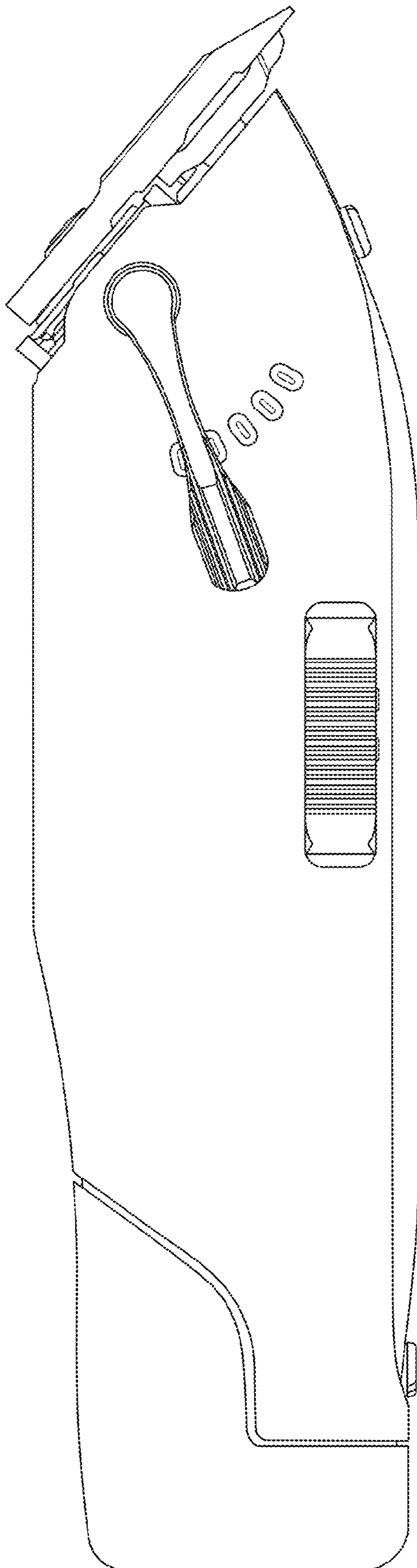

FIG. 13

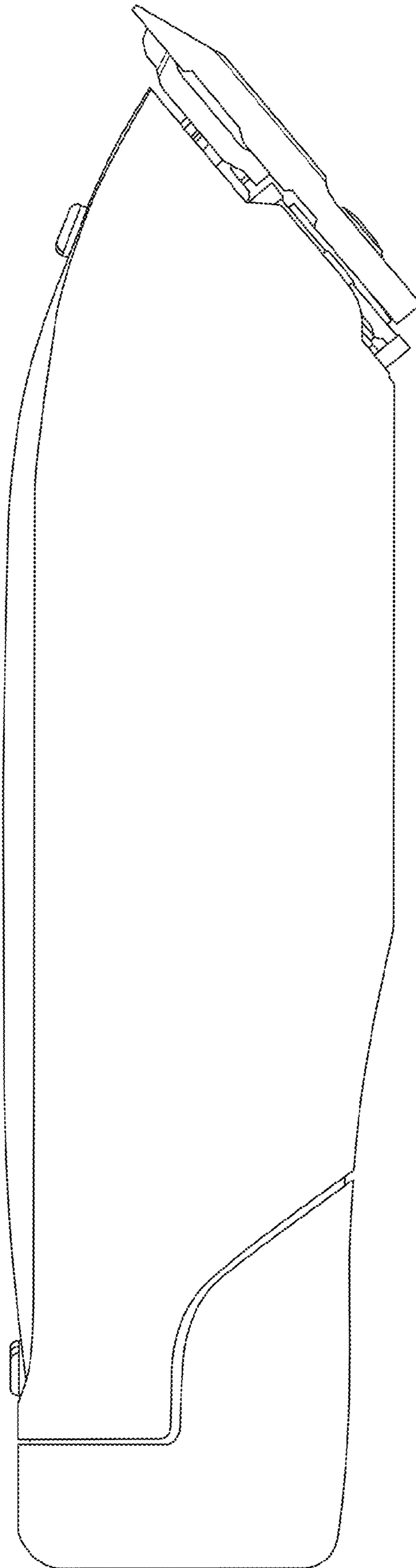

FIG. 14

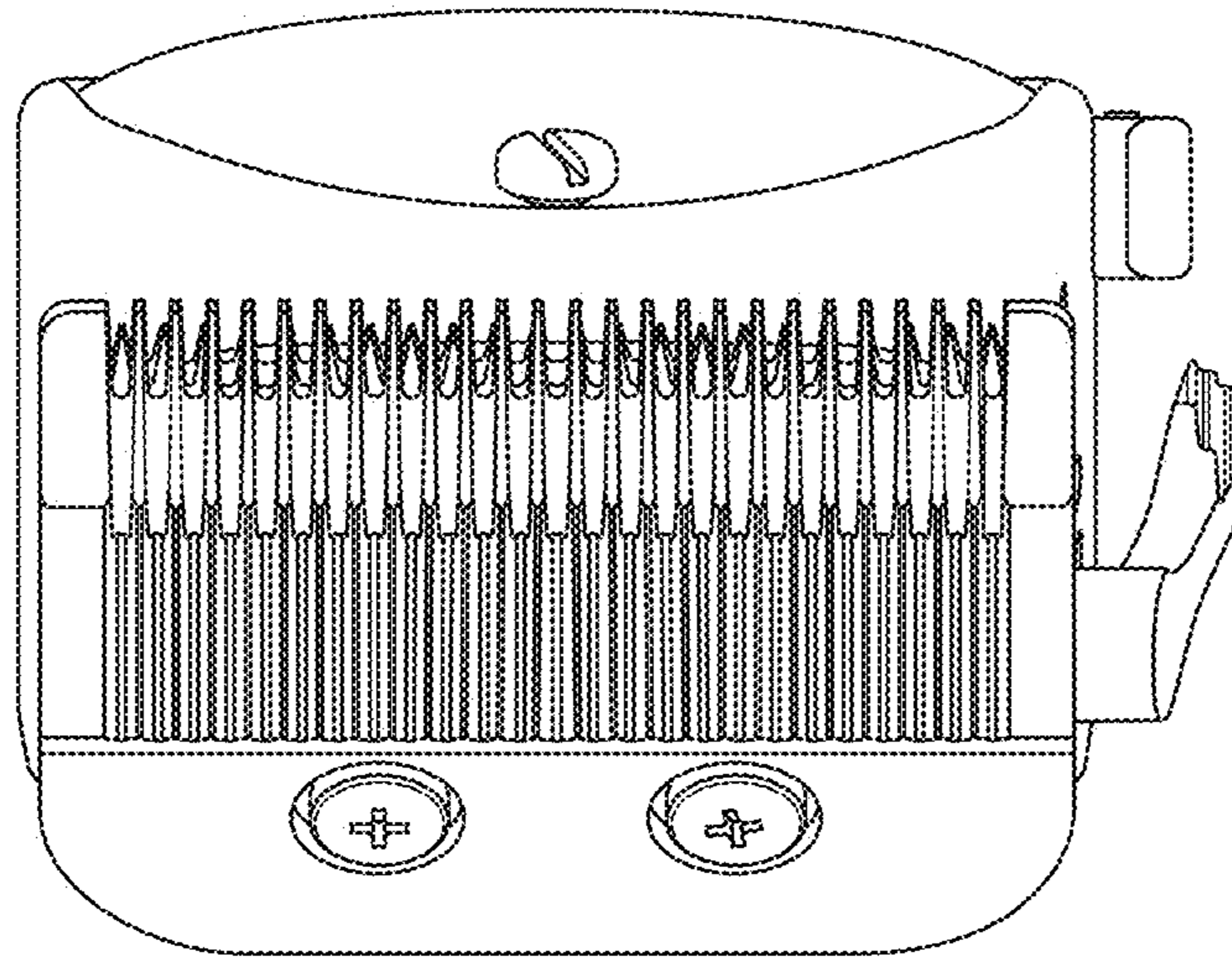

FIG. 15

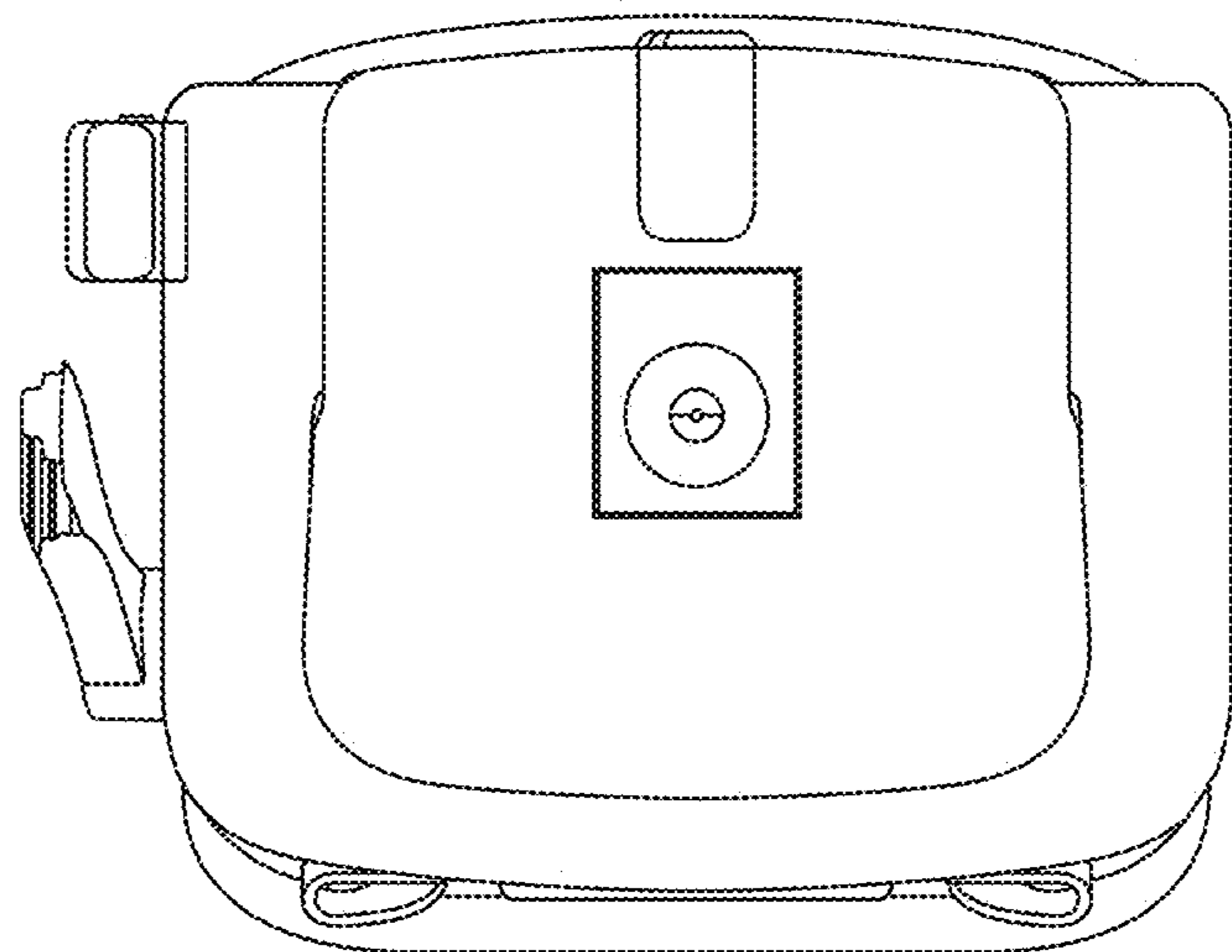

FIG. 16

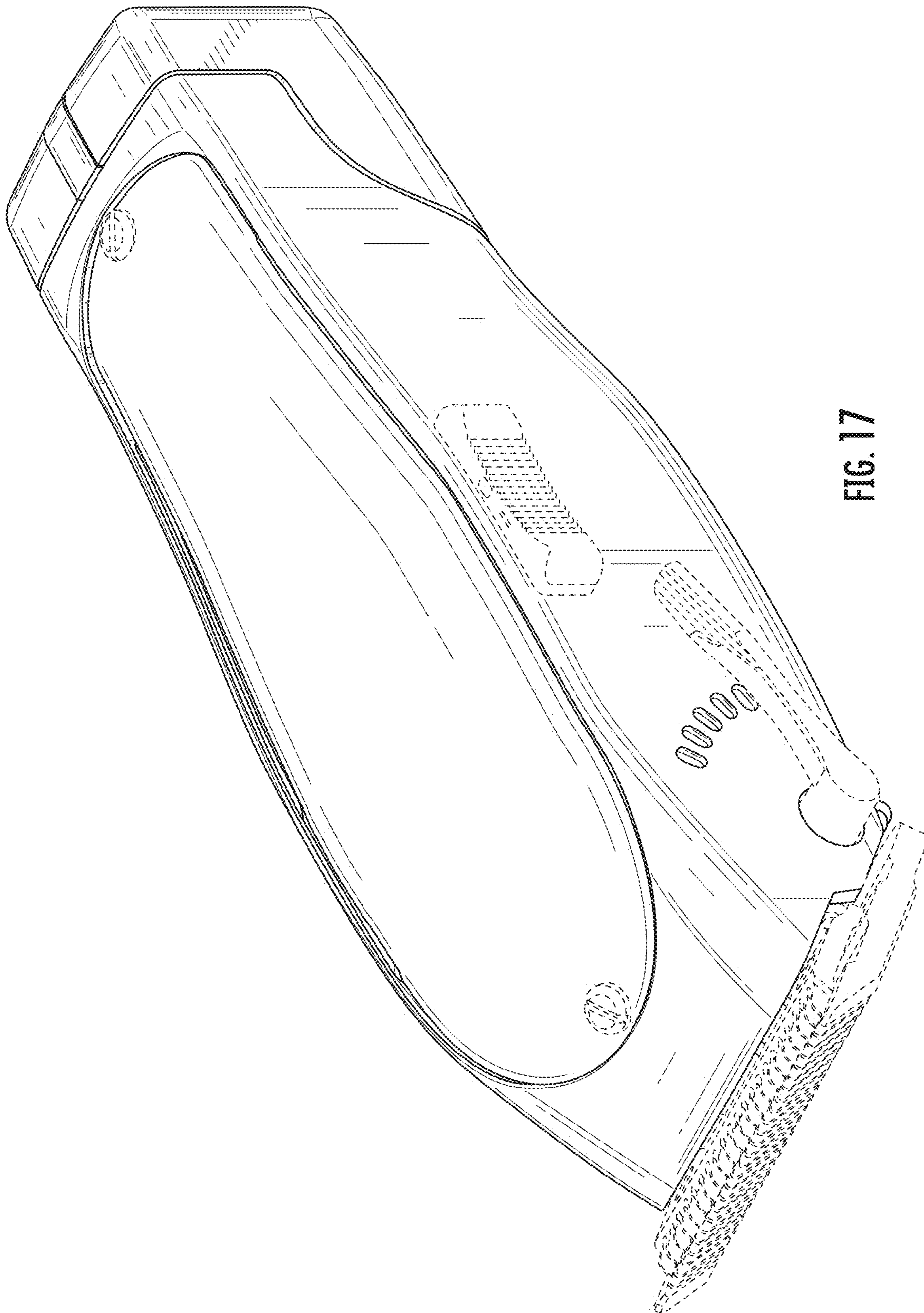

FIG. 17

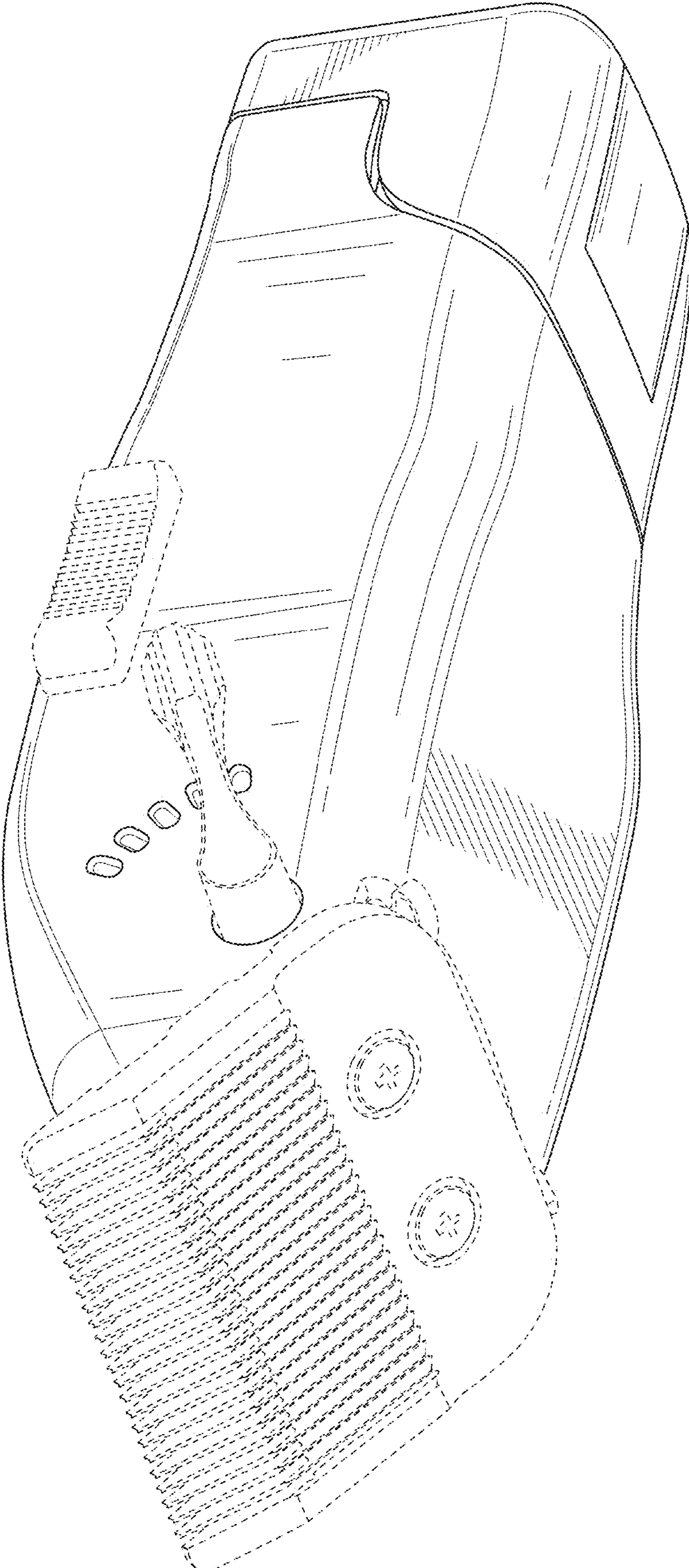

FIG. 18



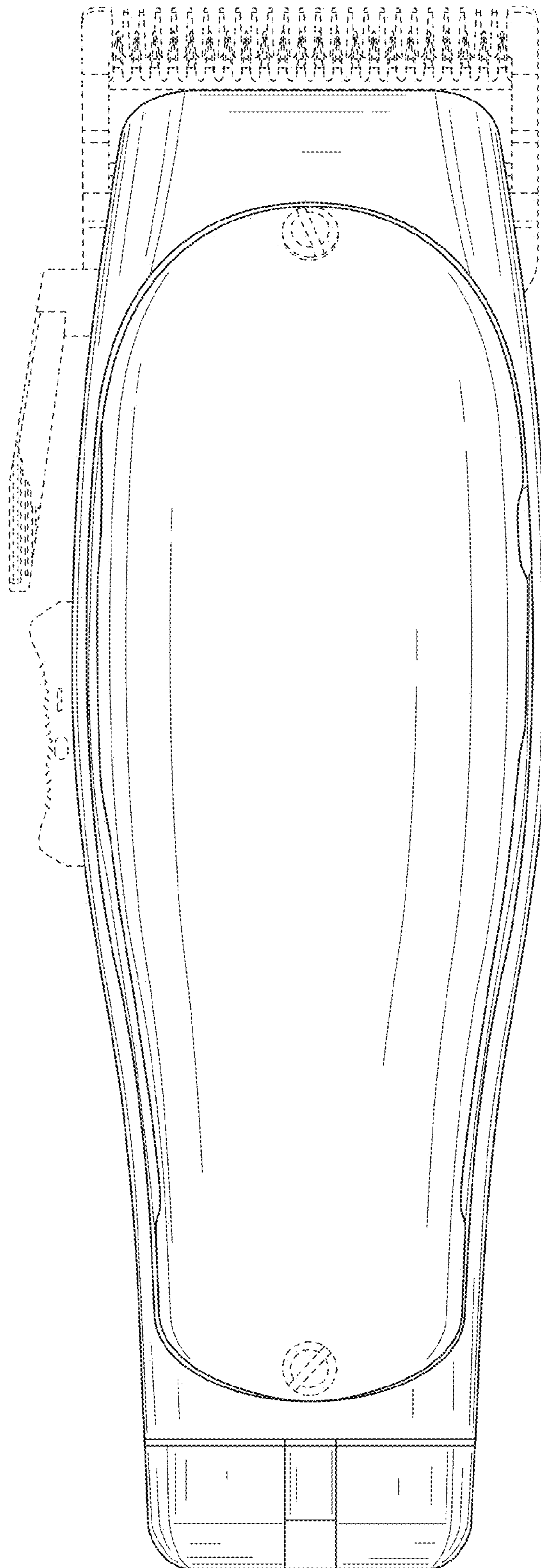

FIG. 19

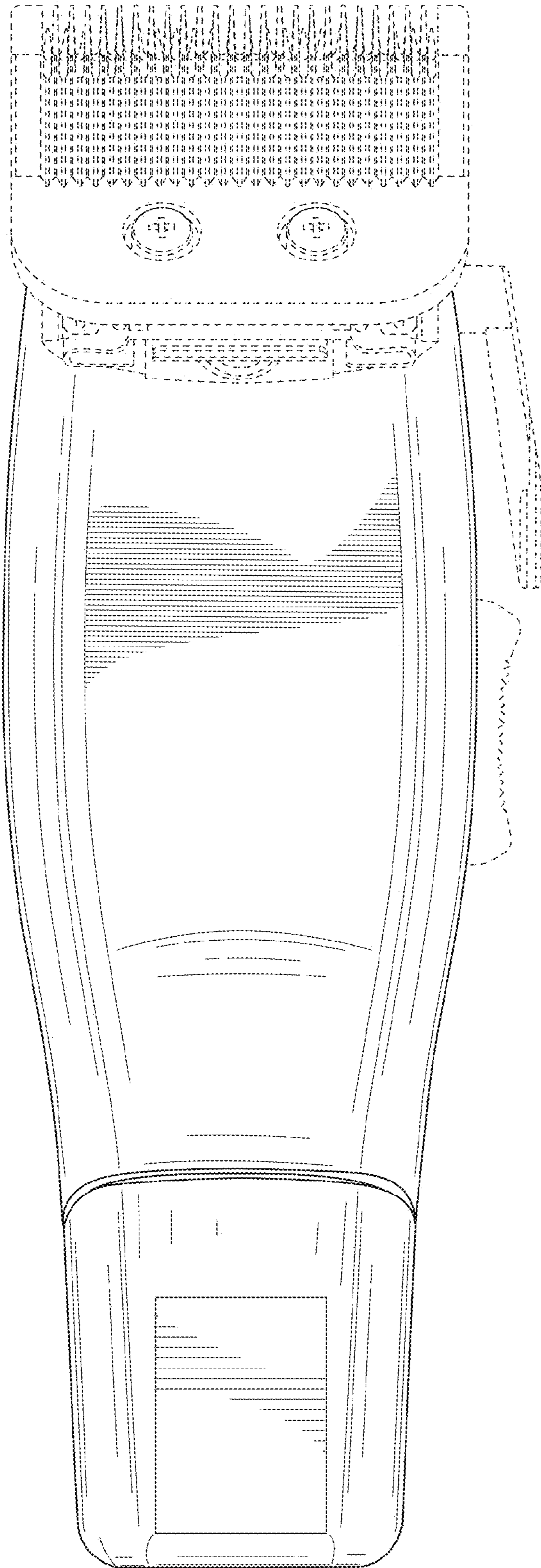

FIG. 20

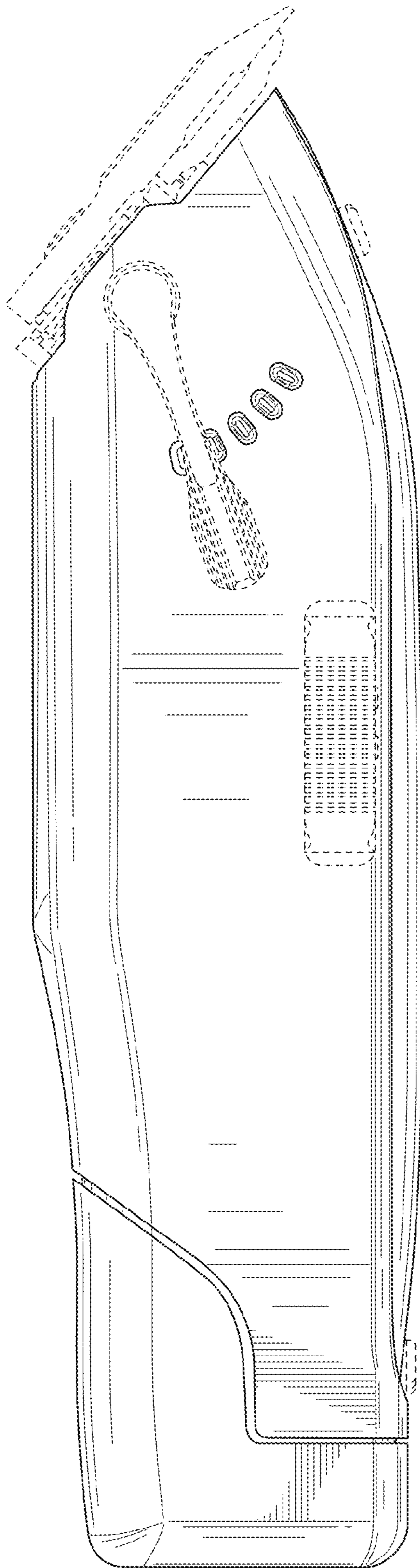

FIG. 21

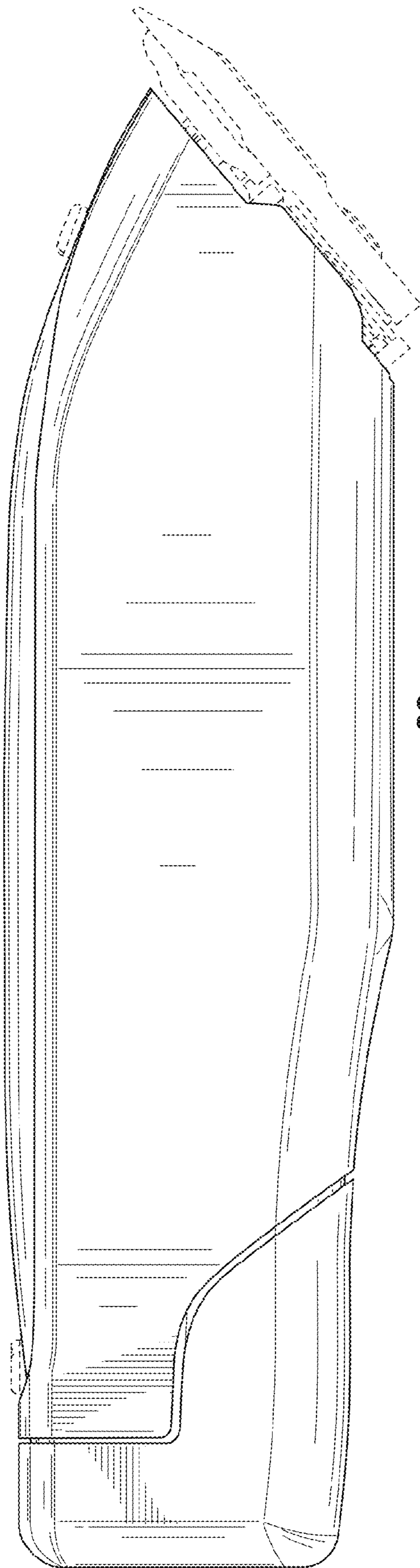

FIG. 22

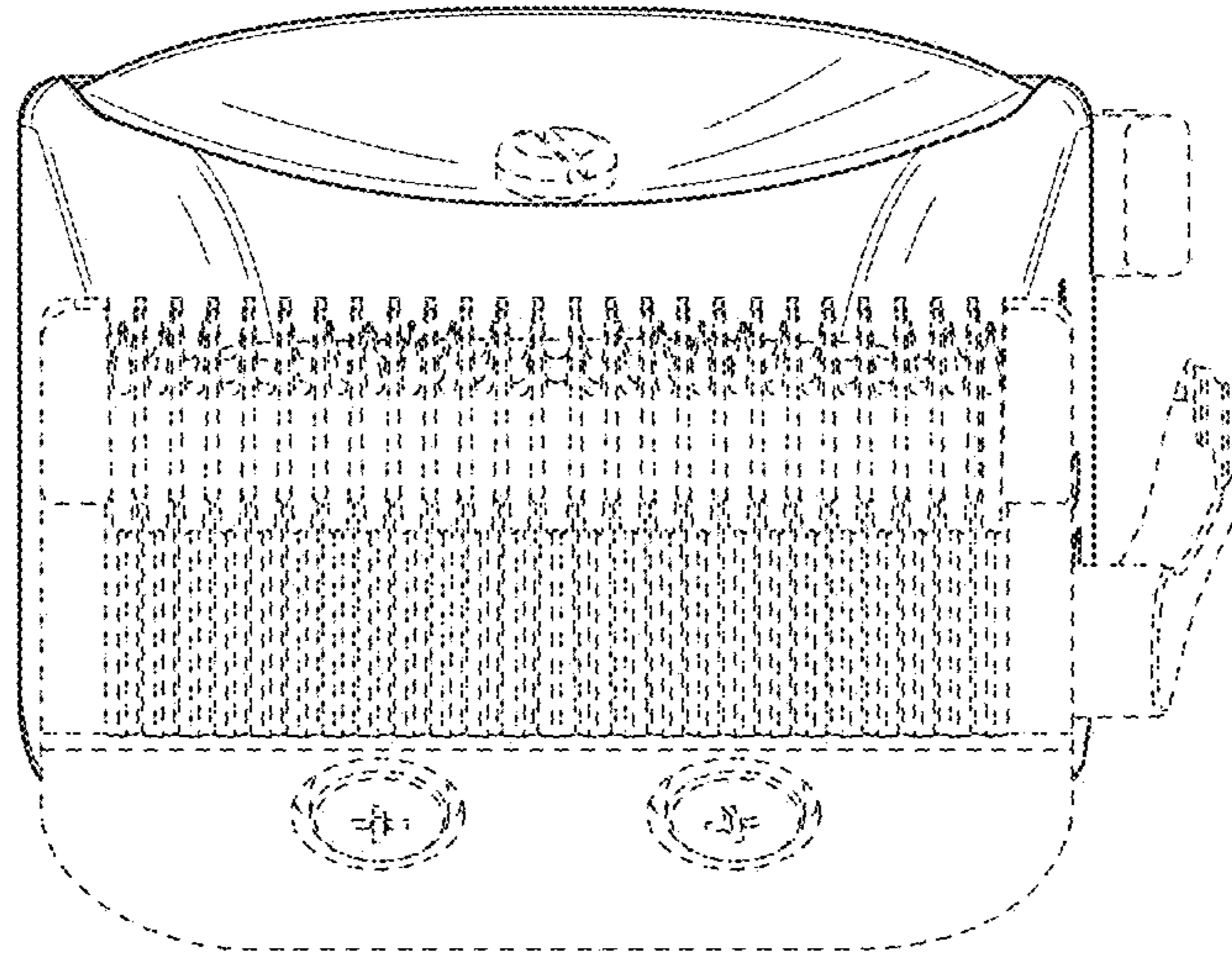

FIG. 23

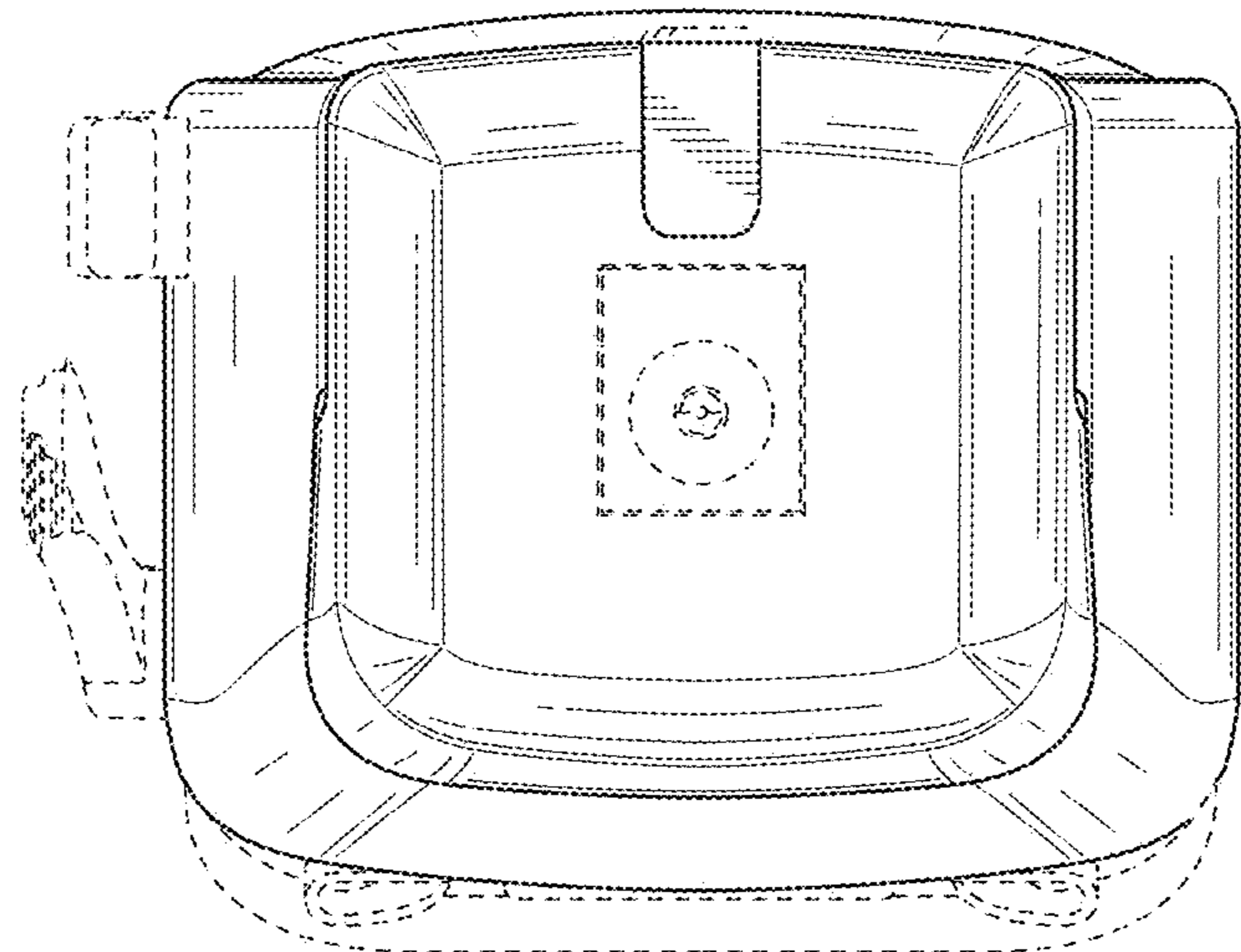

FIG. 24

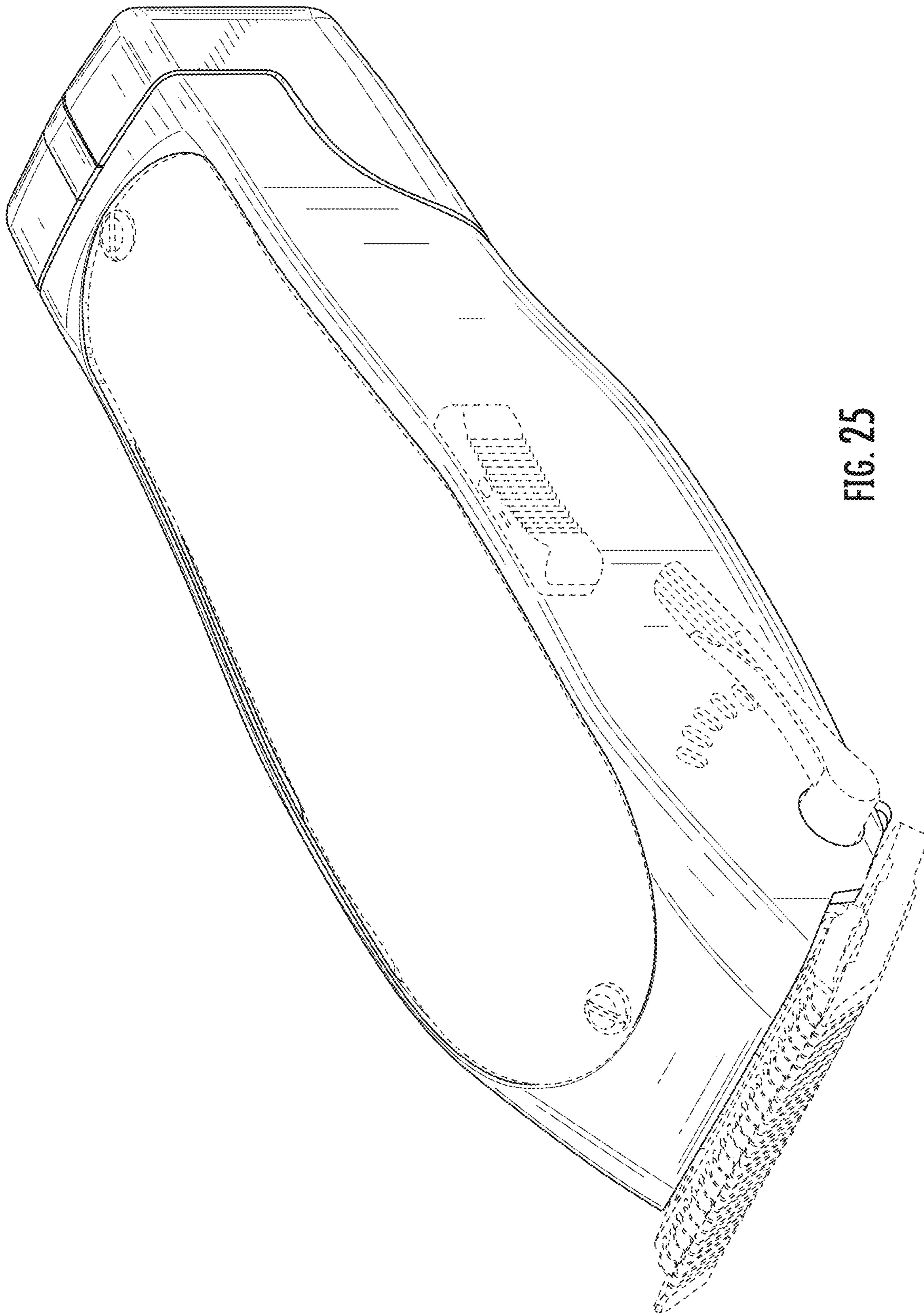

FIG. 25

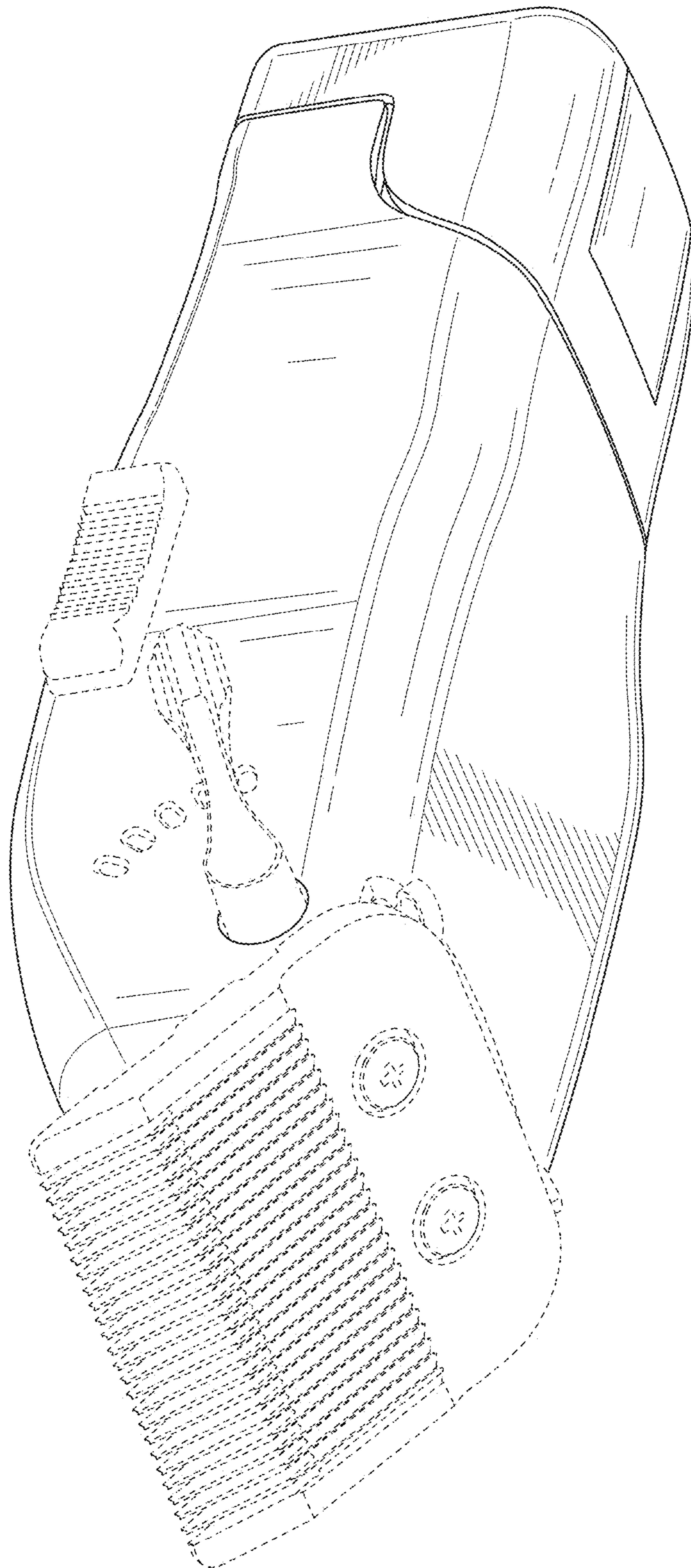

FIG. 26

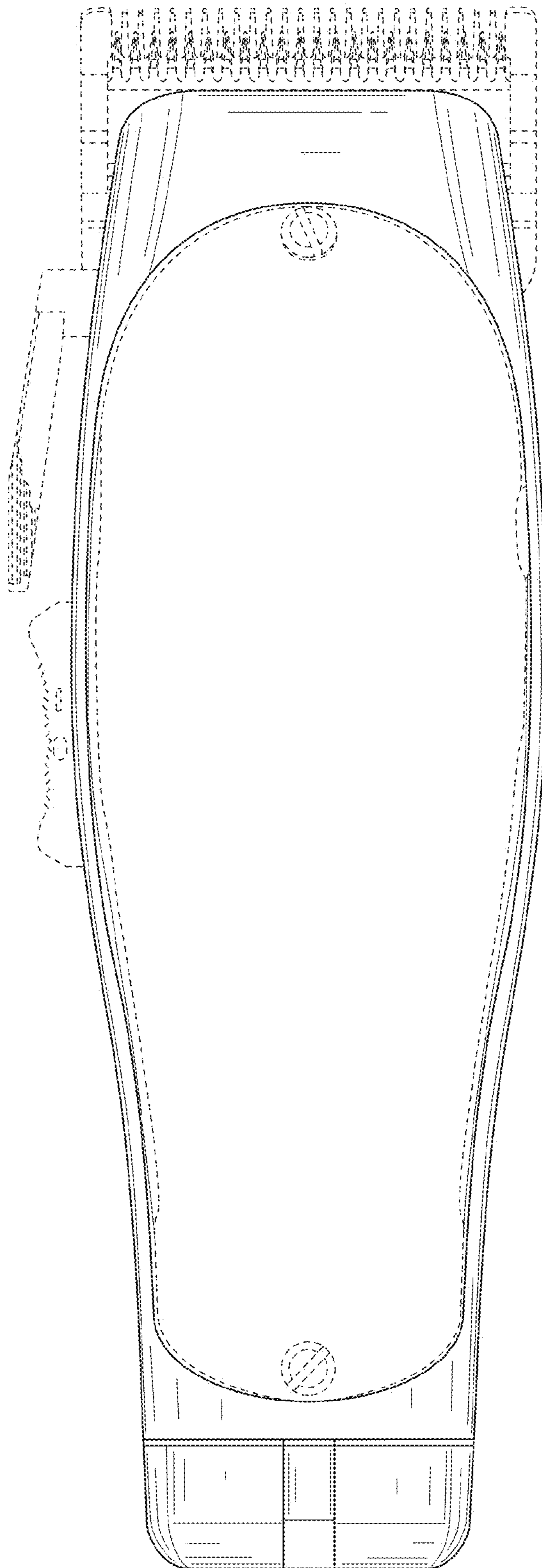

FIG. 27

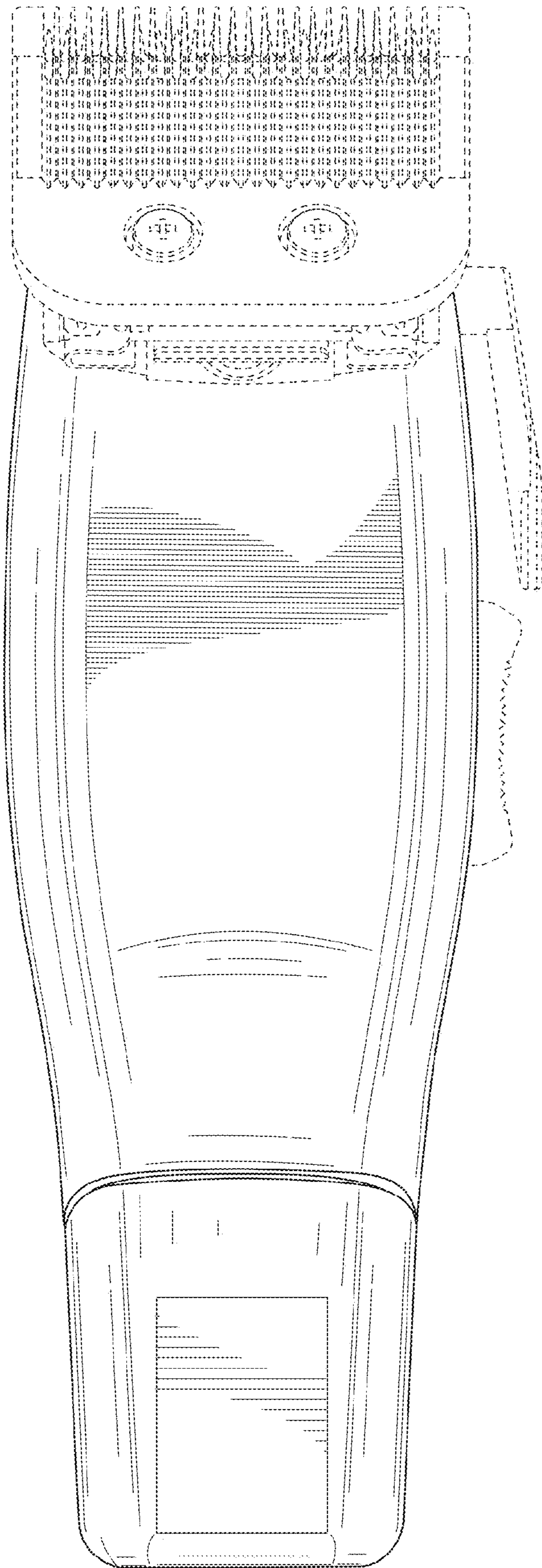

FIG. 28



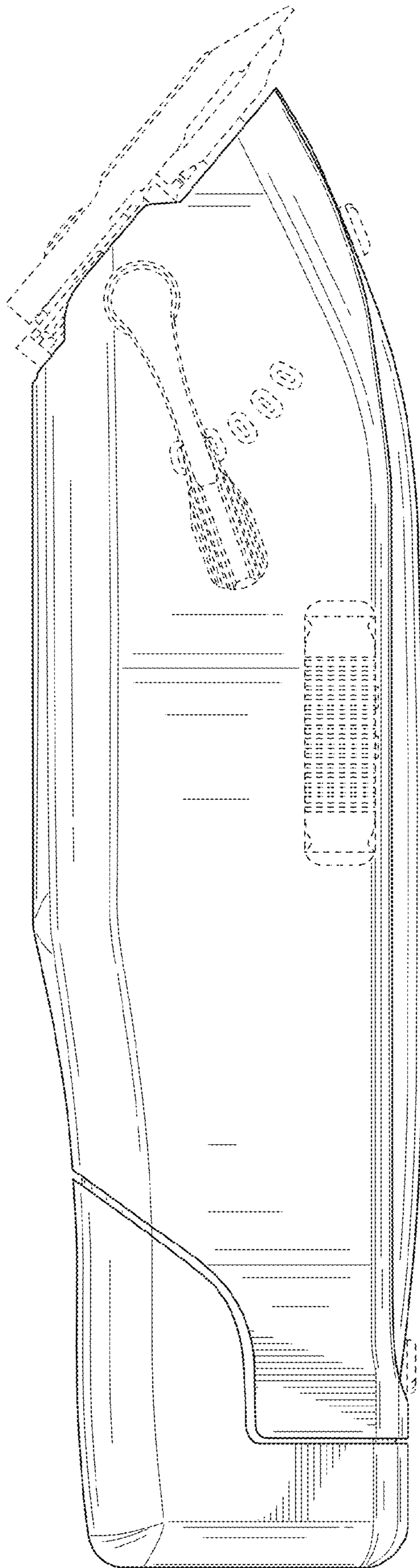

FIG. 29

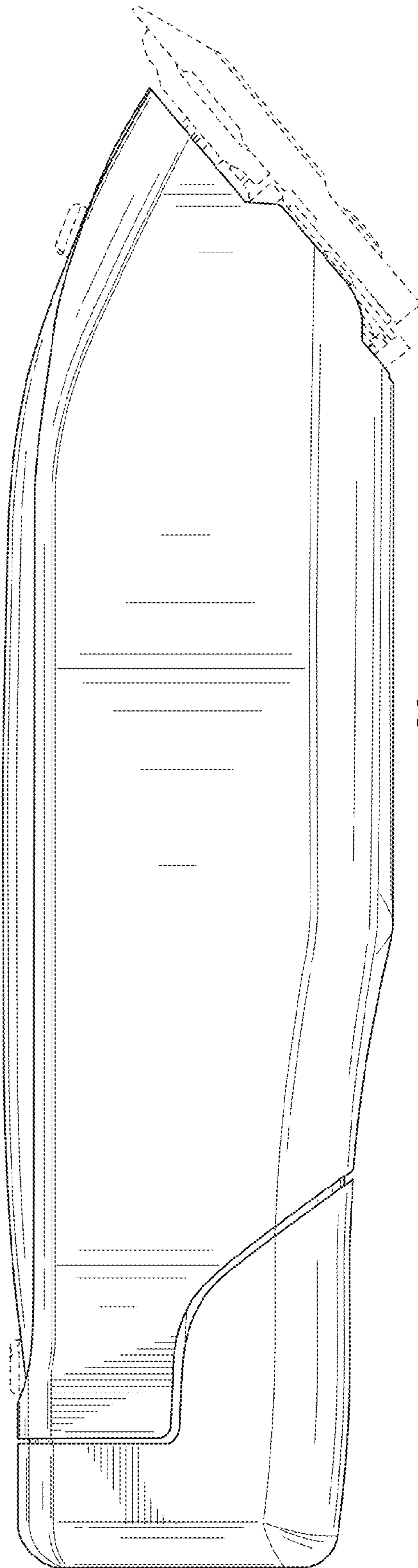

FIG. 30

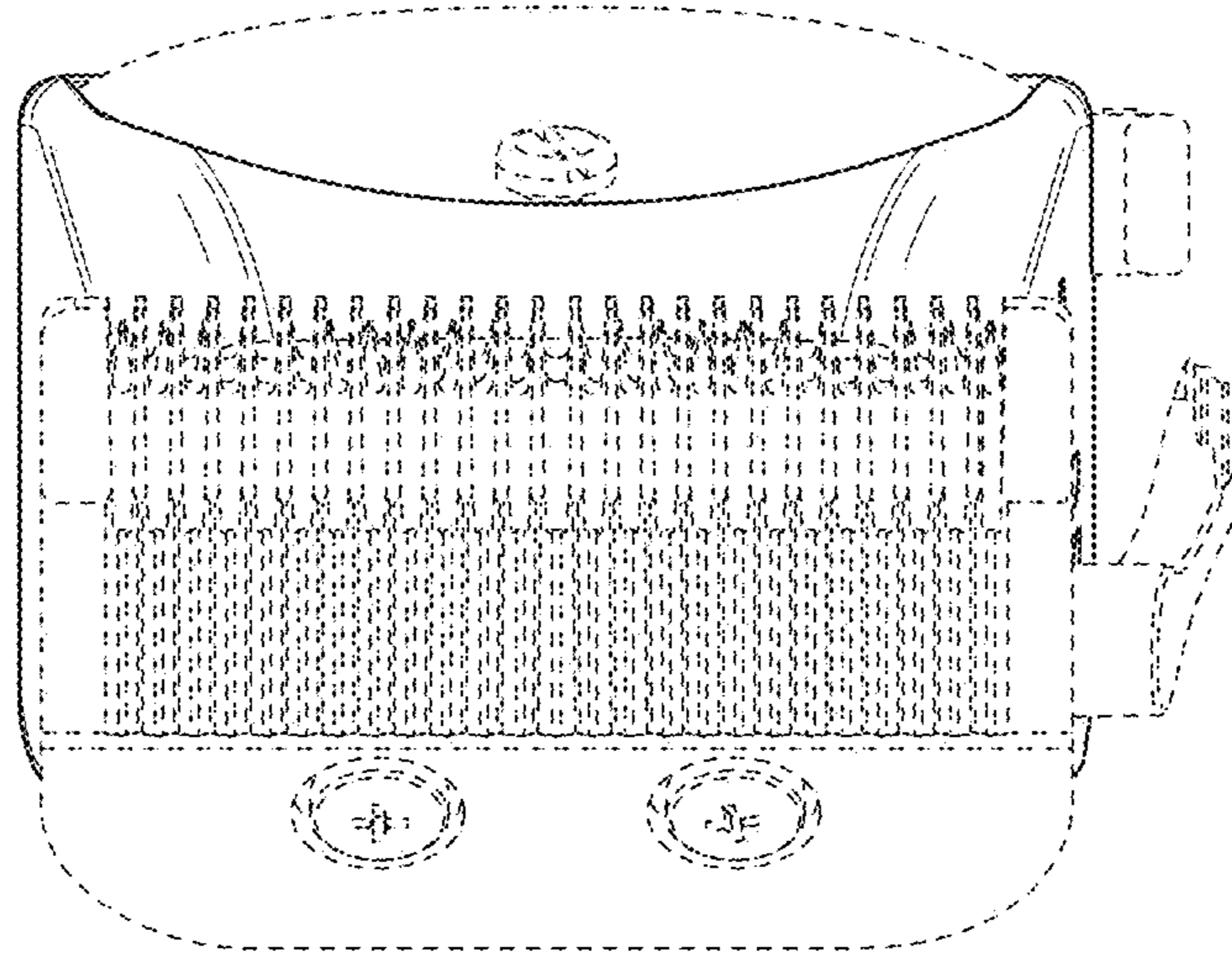

FIG. 31

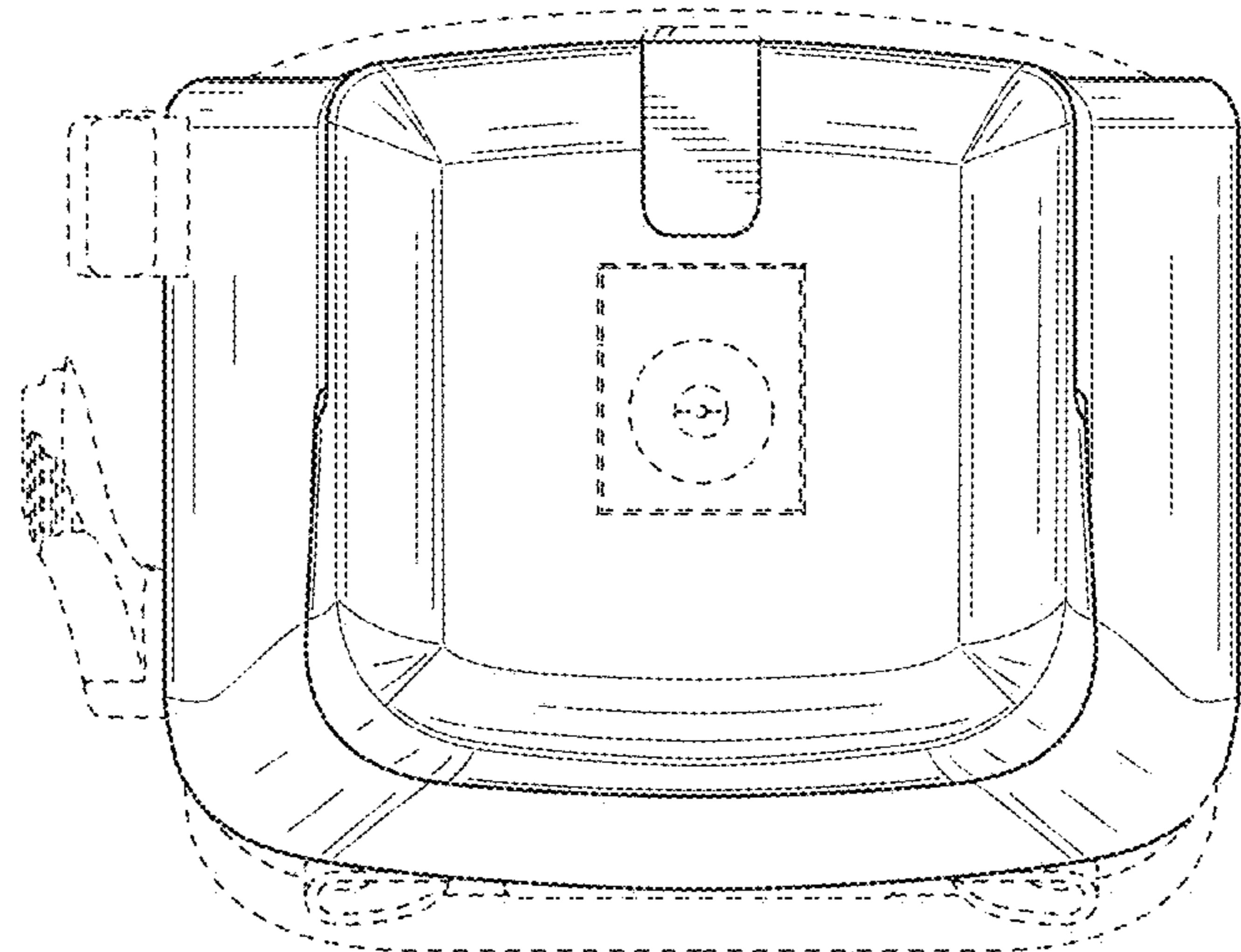

FIG. 32