

US00D931530S

(12) **United States Design Patent**
Lee et al.

(10) **Patent No.:** **US D931,530 S**
(45) **Date of Patent:** **** Sep. 21, 2021**

(54) **BODY DRIER**
(71) Applicant: **LG ELECTRONICS INC.,** Seoul (KR)
(72) Inventors: **Seungyup Lee,** Seoul (KR); **Sangyoon Lee,** Seoul (KR); **Byungsoo Oh,** Seoul (KR)
(73) Assignee: **LG Electronics Inc.,** Seoul (KR)
(**) Term: **15 Years**
(21) Appl. No.: **29/728,135**
(22) Filed: **Mar. 16, 2020**

(30) **Foreign Application Priority Data**
Sep. 27, 2019 (KR) 30-2019-0046711
(51) **LOC (13) Cl.** **28-03**
(52) **U.S. Cl.**
USPC **D28/9**
(58) **Field of Classification Search**
USPC D28/12, 54.1, 58; D23/357, 361, 385
CPC F26B 21/004; A45D 20/00; A47K 10/48;
B05B 1/04
See application file for complete search history.

(56) **References Cited**
U.S. PATENT DOCUMENTS
3,785,523 A * 1/1974 Goldstein A47K 10/44
221/42
3,878,621 A * 4/1975 Duerre A47K 10/48
34/90
4,961,272 A * 10/1990 Lee A47K 10/48
34/202

6,349,484 B1 * 2/2002 Cohen A47K 10/48
34/225
6,962,005 B1 * 11/2005 Khosropour A47K 10/48
34/218
7,900,371 B1 * 3/2011 Bullard A47K 10/48
34/202
8,112,899 B1 * 2/2012 Duckworth A47K 10/48
34/202
2004/0000067 A1 * 1/2004 Baumann A47K 10/48
34/90
2009/0145002 A1 * 6/2009 Brewer A45D 20/12
34/443
2013/0025149 A1 * 1/2013 Farousi A47K 10/48
34/88
2020/0305660 A1 * 10/2020 Benvenisti A47K 10/48

* cited by examiner

Primary Examiner — Zenia I Bennett
(74) *Attorney, Agent, or Firm* — Birch, Stewart, Kolasch & Birch, LLP

(57) **CLAIM**
We claim the ornamental design for a body drier, as shown and described.

DESCRIPTION
FIG. 1 is a perspective view of a body drier showing the new design;
FIG. 2 is a front elevation view thereof;
FIG. 3 is a rear elevation view thereof;
FIG. 4 is a left-side elevation view thereof;
FIG. 5 is a right-side elevation view thereof;
FIG. 6 is a top plan view thereof;
FIG. 7 is a bottom plan view thereof; and,
FIG. 8 is a partial enlarged view thereof.
Broken lines illustrate environmental condition only and form no part of the claimed design.

1 Claim, 8 Drawing Sheets

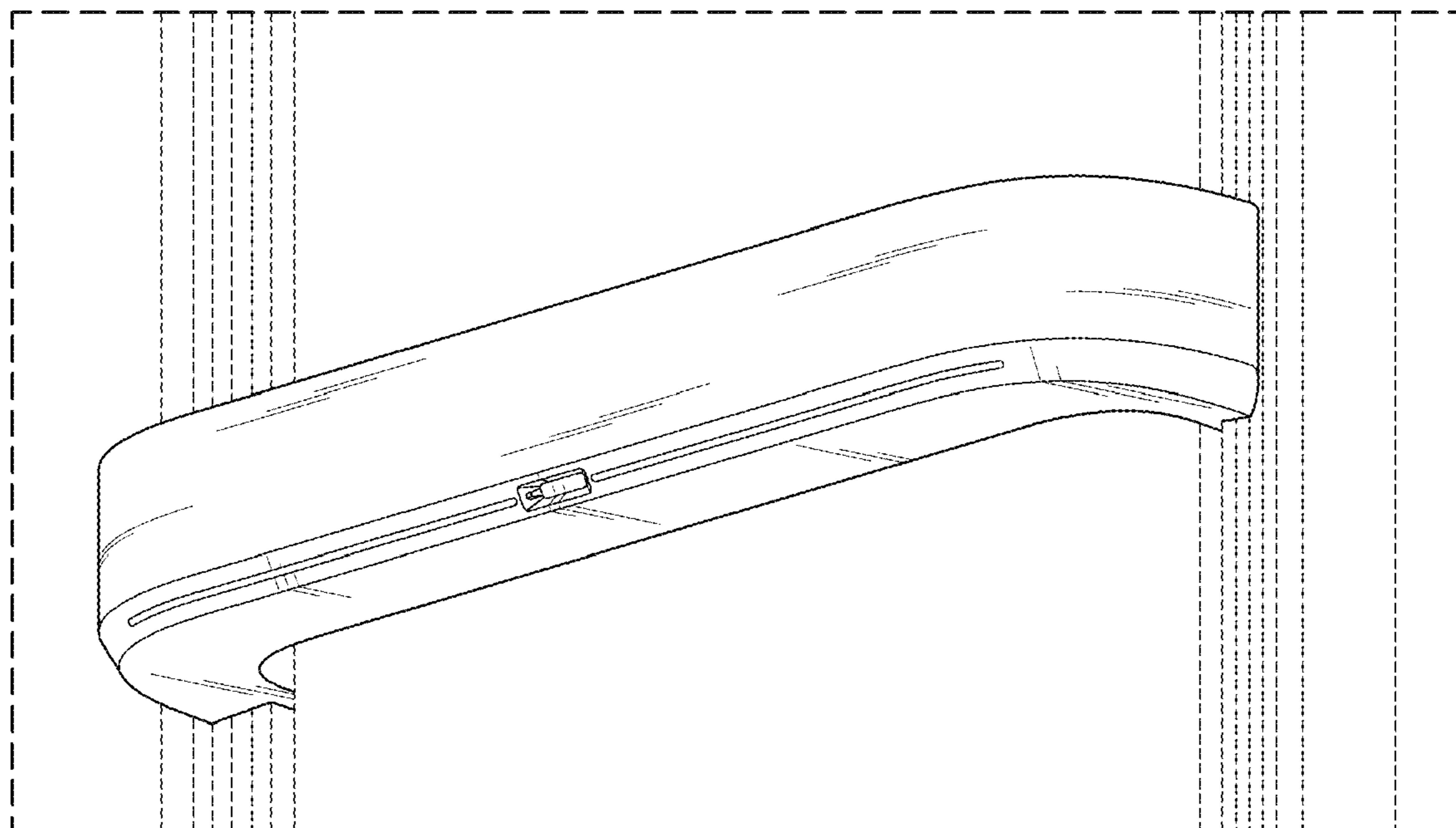

FIG. 1

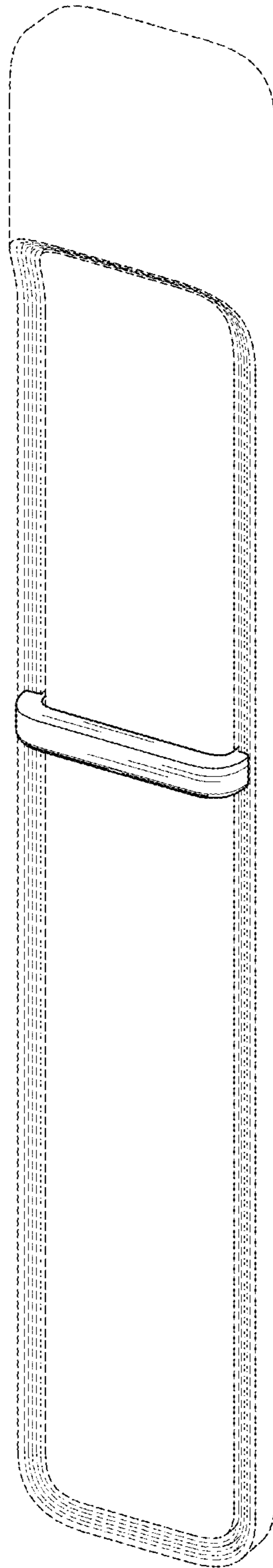

FIG. 2

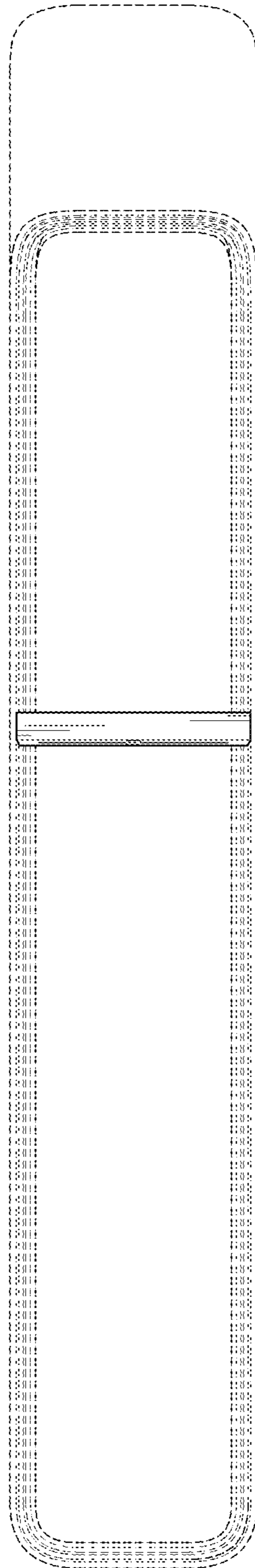

FIG. 3

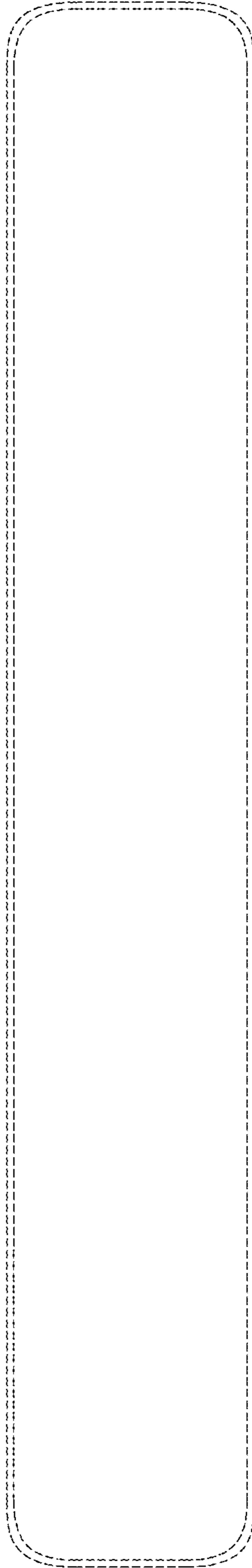

FIG. 4

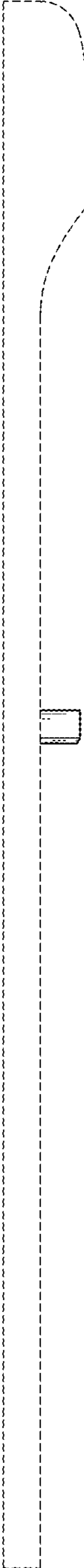

FIG. 5

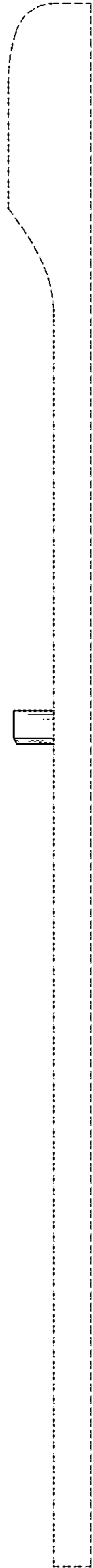

FIG. 6



FIG. 7

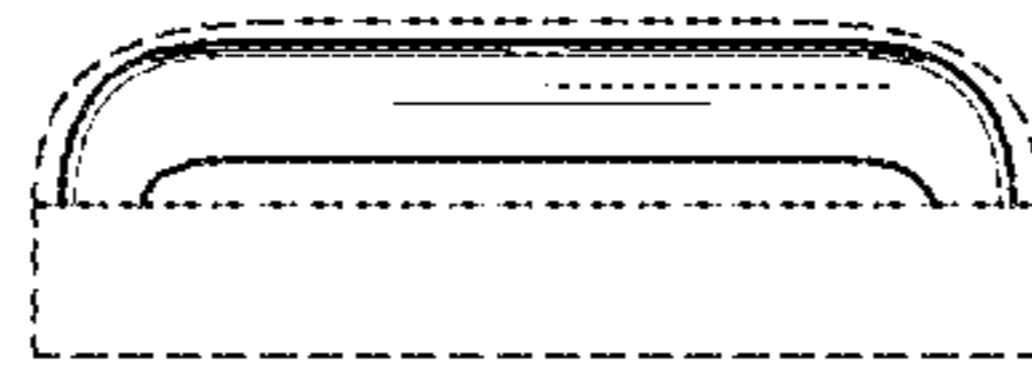

FIG. 8

