



US00D931482S

(12) **United States Design Patent** (10) **Patent No.:** **US D931,482 S**
Guerizec (45) **Date of Patent:** **** Sep. 21, 2021**

- (54) **MESSAGE APPLIANCE**
- (71) Applicant: **DECATHLON**, Villeneuve d'Ascq (FR)
- (72) Inventor: **Johann Guerizec**, Fâches-Thumesnil (FR)
- (73) Assignee: **DECATHLON**, Villeneuve d'Ascq (FR)
- (**) Term: **15 Years**
- (21) Appl. No.: **29/711,014**
- (22) Filed: **Oct. 28, 2019**
- (30) **Foreign Application Priority Data**
Apr. 29, 2019 (EM) 006402756-0001
- (51) **LOC (13) Cl.** **28-03**
- (52) **U.S. Cl.**
USPC **D24/211**
- (58) **Field of Classification Search**
USPC D24/133, 186, 211, 212, 213, 214, 215;
D12/114, 178; D21/679; D8/303;
D30/160
CPC A61H 15/00; A61H 7/001; A61H
2015/0014; A61H 7/007
See application file for complete search history.

- (56) **References Cited**
U.S. PATENT DOCUMENTS
D246,727 S * 12/1977 Holkesvick D24/211
D248,493 S * 7/1978 Moncrief 601/120
D256,503 S * 8/1980 Moustakas D24/212
D269,375 S * 6/1983 Masuda D24/211
D271,051 S * 10/1983 McCoy D21/679
D285,117 S * 8/1986 Snyder D24/211
D337,827 S * 7/1993 Seng D24/211
D345,610 S * 3/1994 Shih D24/211
D347,898 S * 6/1994 Belcher D24/200

- D371,202 S * 6/1996 Zajas D24/211
- 5,577,996 A * 11/1996 Gardner A61H 15/0092
601/118
- D398,400 S * 9/1998 Havelind D24/211
- D399,569 S * 10/1998 Wier D24/212
- D446,584 S * 8/2001 Chen D21/662
- D448,851 S * 10/2001 Louis D24/211
- D648,034 S * 11/2011 Rice D24/215
- D650,487 S * 12/2011 Briscoe D24/211
- D654,970 S * 2/2012 Daves D21/662
- D657,009 S * 4/2012 Krull D21/672
- D674,107 S * 1/2013 Prudent D24/211
- D699,794 S * 2/2014 Wauldron D21/662

(Continued)

OTHER PUBLICATIONS

Decathlon, "Massage Kit 3 in 1", Oct. 18, 2020. <https://www.decathlon.com/products/3-in-1-massage-kit-discovery-100-massage-ball-stick-and-roller?variant=30301616668734>. Shown on p. 1. (Year: 2020).*

Primary Examiner — Cynthia Ramirez
Assistant Examiner — Michael A Maharajh
(74) *Attorney, Agent, or Firm* — Fross, Zelnick, Lehrman & Zissu, PC; Charles T. J. Weigell, Esq.

(57) **CLAIM**

The ornamental design for a massage appliance, as shown and described.

DESCRIPTION

FIG. 1 is a front perspective view of a massage appliance showing my new design;
FIG. 2 is a front view thereof;
FIG. 3 is a back view thereof;
FIG. 4 is a left side view thereof, shown at an enlarged scale;
FIG. 5 is a right side view thereof, shown at an enlarged scale;
FIG. 6 is a top view thereof; and,
FIG. 7 is a bottom view thereof.

1 Claim, 5 Drawing Sheets

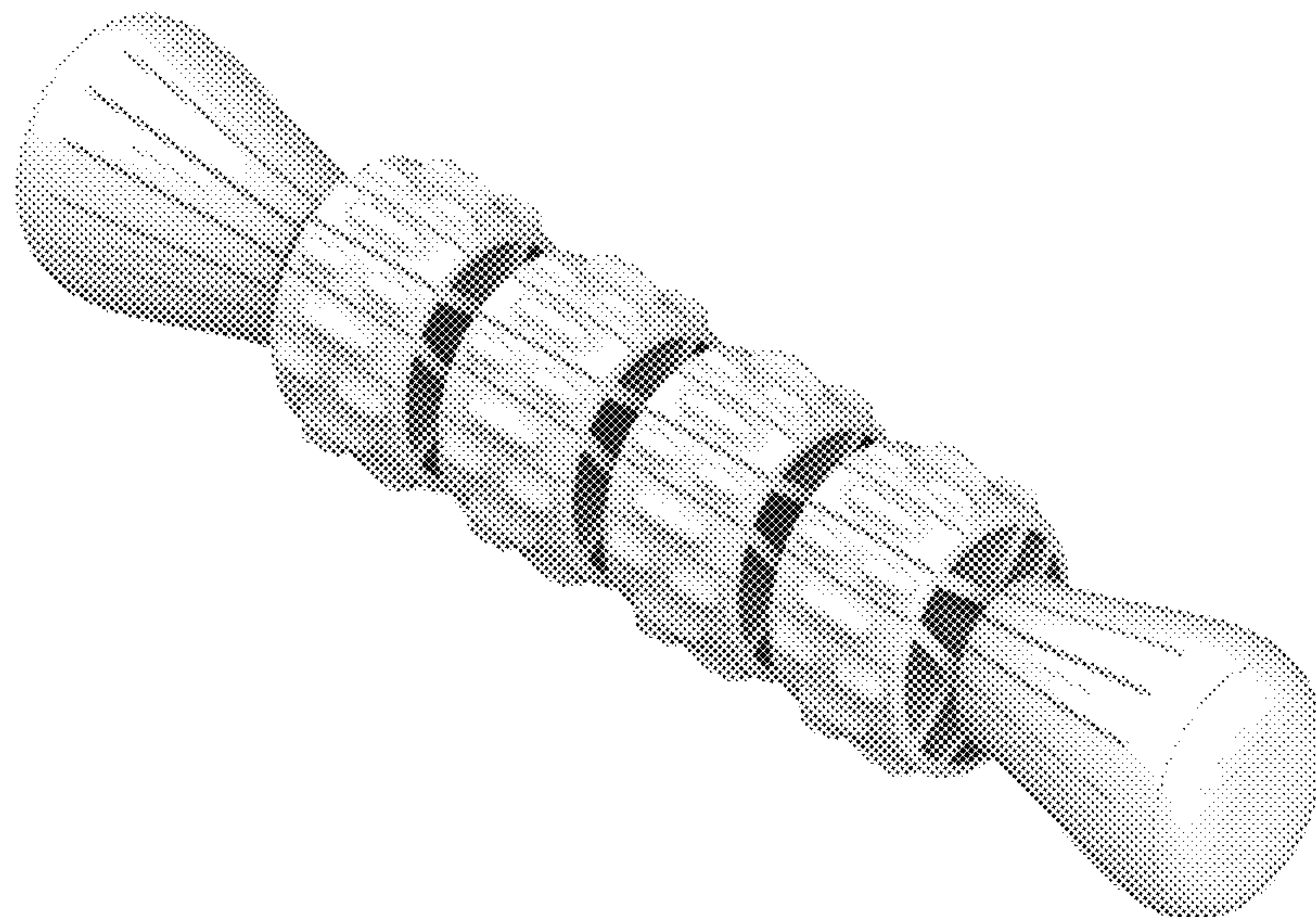

(56)

References Cited

U.S. PATENT DOCUMENTS

D700,346 S * 2/2014 Palizzi D24/211
D704,852 S * 5/2014 Yang D24/211
D723,710 S * 3/2015 Ishibashi D24/215
D738,519 S * 9/2015 Phillips D24/211
D744,663 S * 12/2015 Holland D24/211
D750,841 S * 3/2016 Lewis D28/91.2
D754,868 S * 4/2016 Hendrickson D24/211
D802,782 S * 11/2017 Cross D24/211
9,808,665 B1 * 11/2017 Demarais A61H 15/0092
D838,376 S * 1/2019 Liu D24/211
D848,009 S * 5/2019 O'Keefe D24/211
D866,785 S * 11/2019 Tarashchansky D24/215
D885,599 S * 5/2020 Guerizec D24/211
2008/0200851 A1 * 8/2008 Faussett A61H 15/0092
601/119
2011/0257569 A1 * 10/2011 Robins A61H 15/00
601/137
2013/0012848 A1 * 1/2013 Forrest A61H 15/02
601/19
2013/0096472 A1 * 4/2013 Bertram A61H 15/0092
601/120
2013/0116099 A1 * 5/2013 Briscoe A61H 15/0092
482/139
2014/0243718 A1 * 8/2014 Black A61H 7/003
601/120
2015/0374576 A1 * 12/2015 Dagan A61H 15/0092
601/119
2016/0008213 A1 * 1/2016 Cheng A61H 15/0092
601/120
2018/0263843 A1 * 9/2018 Chen A61H 15/02
2019/0151189 A1 * 5/2019 Morris A61H 15/00
2019/0343713 A1 * 11/2019 Boghosian A61H 15/0092
2020/0188219 A1 * 6/2020 Piucci, Jr. A61H 1/00
2020/0397650 A1 * 12/2020 Morris A61H 15/0092

* cited by examiner

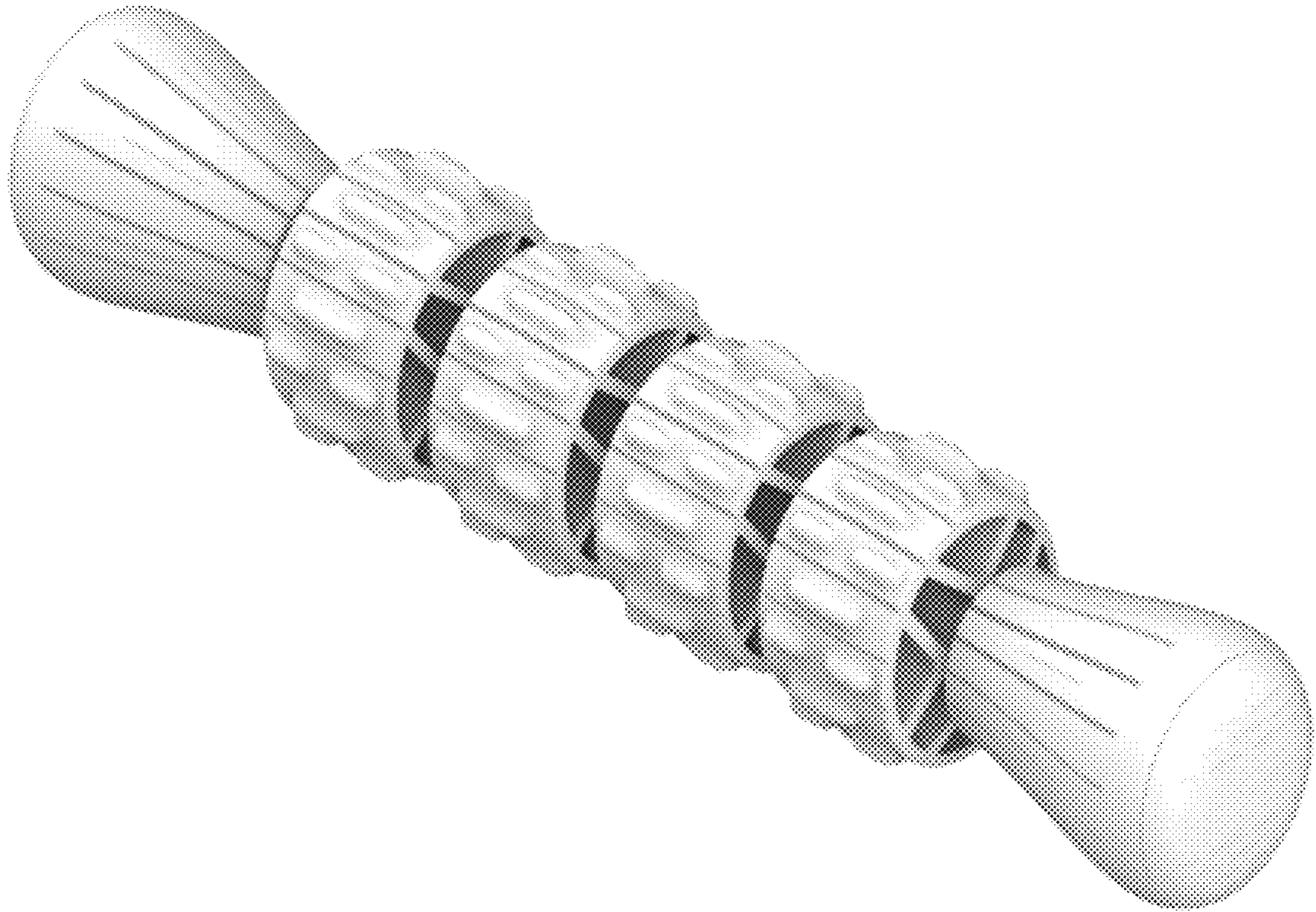

FIG. 1

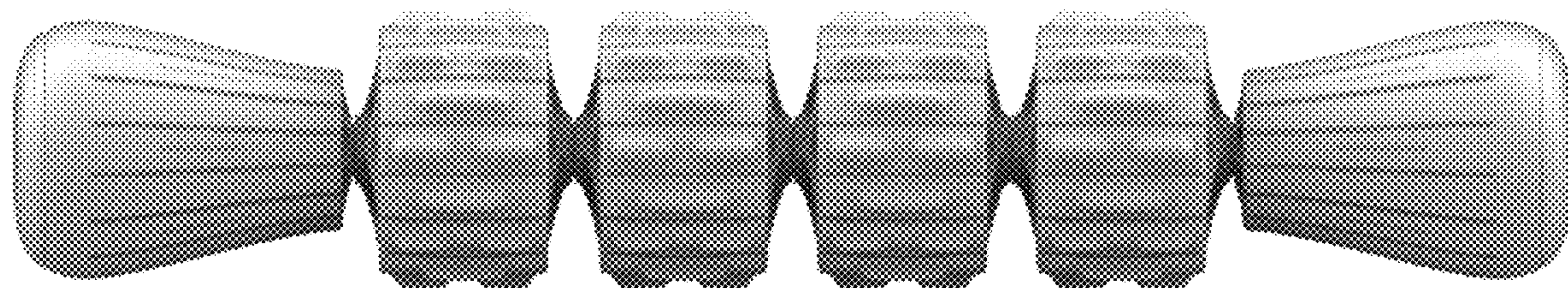

FIG. 2

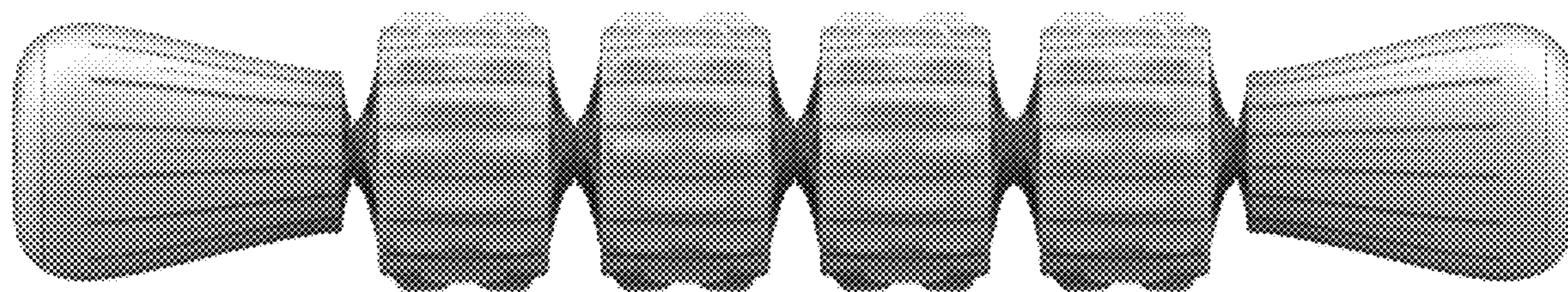

FIG. 3

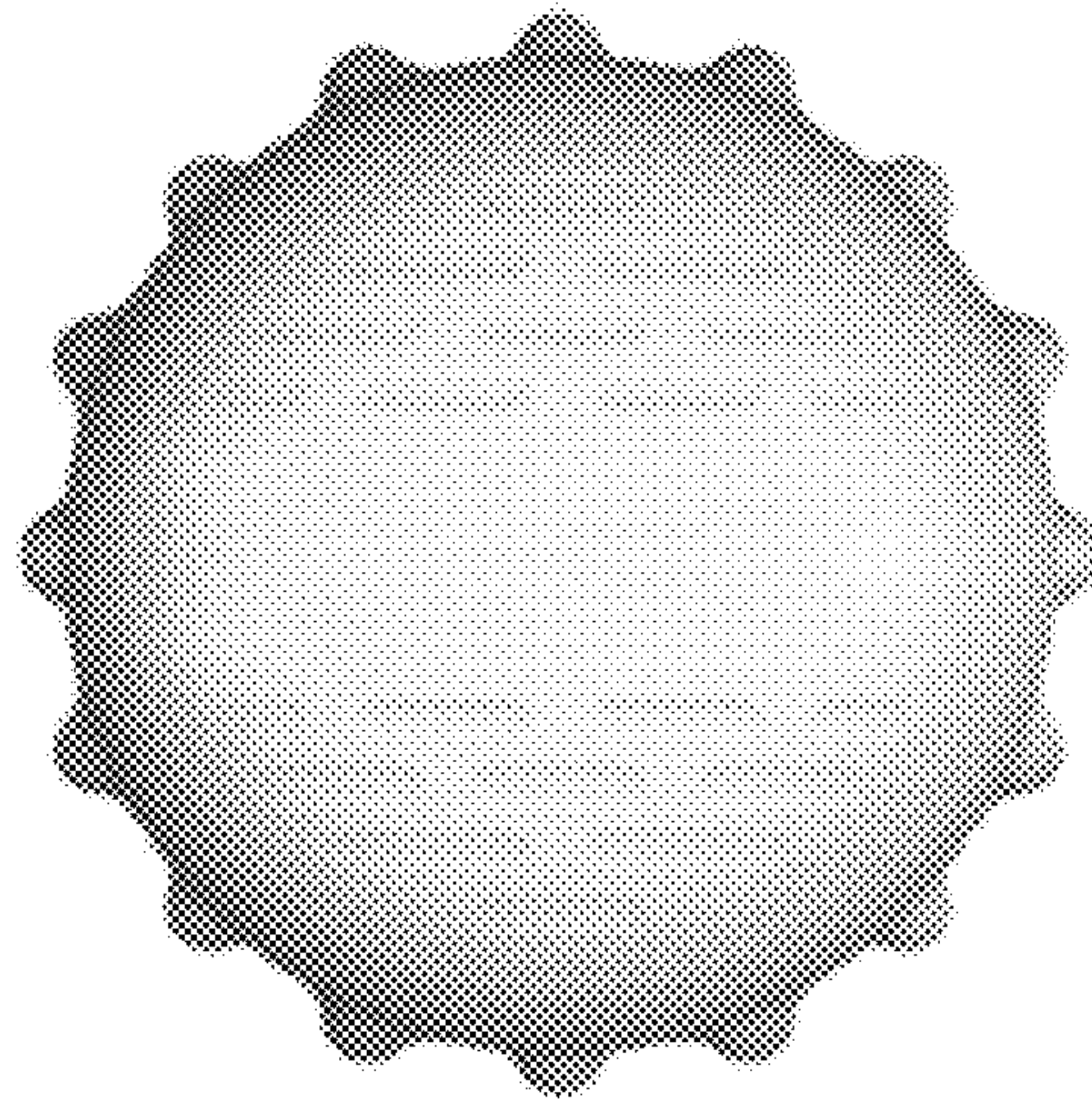

FIG. 4

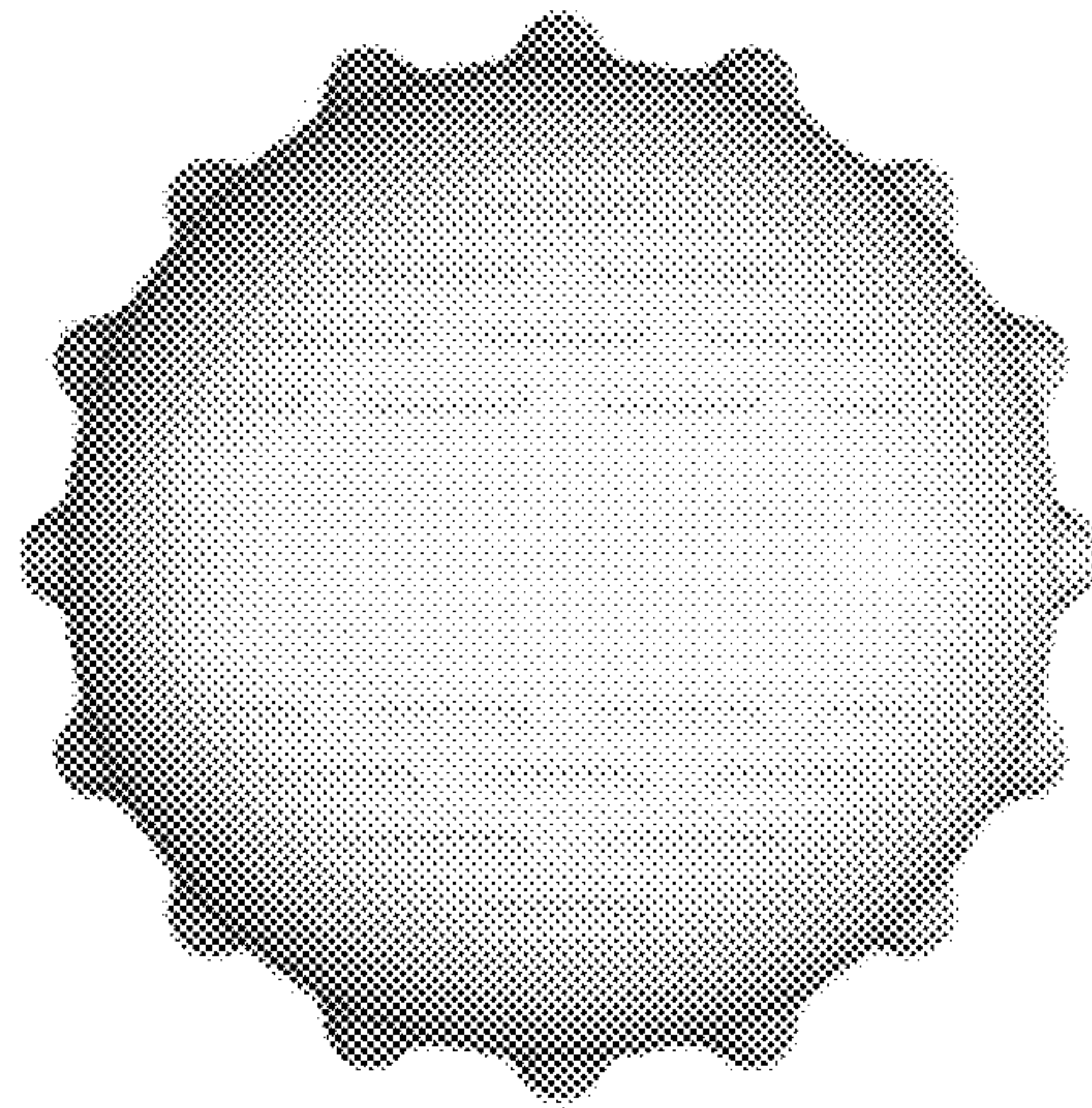

FIG. 5

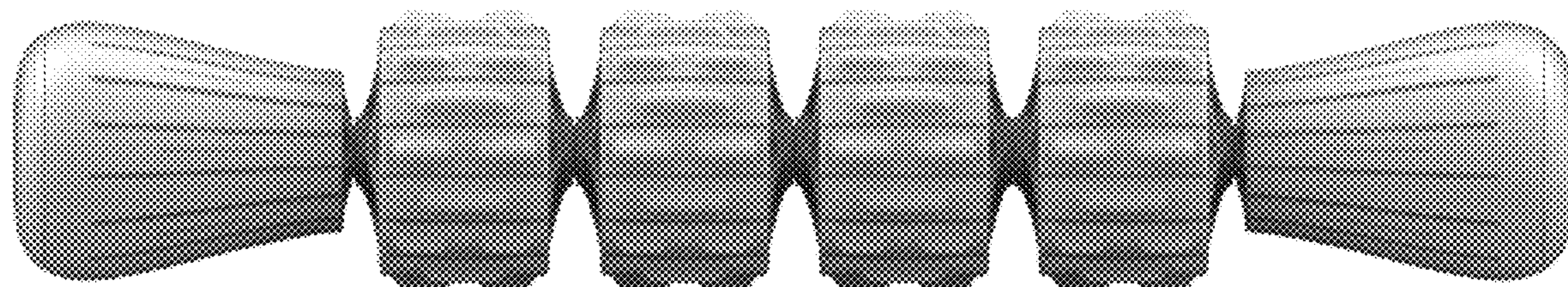

FIG. 6

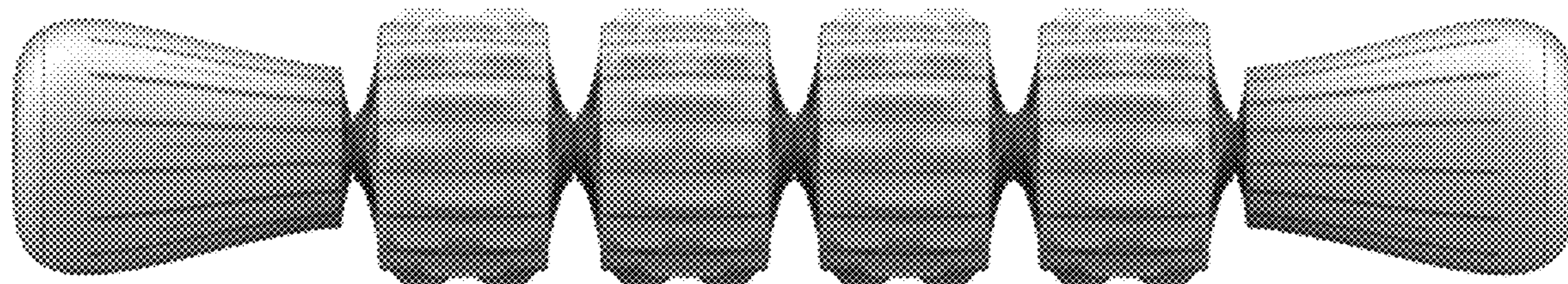

FIG. 7