



US00D931463S

(12) **United States Design Patent** (10) **Patent No.:** **US D931,463 S**
Achleitner (45) **Date of Patent:** **** Sep. 21, 2021**

(54) **MEDICAL IMAGING APPARATUS**

(71) Applicant: **Siemens Healthcare GmbH**, Erlangen (DE)

(72) Inventor: **Roman Achleitner**, Nuremberg (DE)

(73) Assignee: **Siemens Healthcare GmbH**, Erlangen (DE)

(**) Term: **15 Years**

(21) Appl. No.: **29/735,523**

(22) Filed: **May 21, 2020**

(30) **Foreign Application Priority Data**

Nov. 22, 2019 (EM) 007277728

(51) **LOC (13) Cl.** **24-01**

(52) **U.S. Cl.**
USPC **D24/158**

(58) **Field of Classification Search**
USPC D24/158-161, 185, 186, 107
CPC .. A61B 5/05; A61B 5/055; A61B 6/03; A61B 6/035

See application file for complete search history.

(56) **References Cited**

U.S. PATENT DOCUMENTS

D420,134 S *	2/2000	Kitayama	D24/159
D683,023 S *	5/2013	Andersson	D24/158
D701,313 S *	3/2014	Ohmukai	D24/158
D716,948 S *	11/2014	Yokoyama	D24/158
D785,181 S *	4/2017	Grosshauser	D24/158
D785,182 S *	4/2017	Grosshauser	D24/158
D785,801 S *	5/2017	Grosshauser	D24/158

D842,994 S *	3/2019	Avranches	D24/158
D843,577 S *	3/2019	Zhi	D24/158
D843,578 S *	3/2019	Avranches	D24/158
D868,262 S *	11/2019	Achleitner	D24/158
2012/0140899 A1 *	6/2012	Bailey	A61B 6/035 378/198
2020/0175733 A1 *	6/2020	Yu	A61B 6/485

OTHER PUBLICATIONS

Computed Tomography, posted at siemens-healthineers.com, no posting date, retrieved Nov. 7, 2020, online, URL: <https://www.siemens-healthineers.com/en-us/computed-tomography> (Year: 2020).*

* cited by examiner

Primary Examiner — Lilyana Bekic

Assistant Examiner — Mary Shannon Malley

(74) *Attorney, Agent, or Firm* — Schiff Hardin LLP

(57) **CLAIM**

The ornamental design for a medical imaging apparatus, as shown and described.

DESCRIPTION

FIG. 1 is a front view of a medical imaging apparatus showing our new design;

FIG. 2 is a back elevational view thereof;

FIG. 3 is a top plan view thereof;

FIG. 4 is a bottom plan view thereof;

FIG. 5 is a right-side elevational view thereof;

FIG. 6 is a left-side elevational view thereof; and,

FIG. 7 is a perspective view taken generally from the top, front, left-hand side thereof.

The broken lines shown in the drawings represent portions of the medical imaging apparatus that form no part of the claimed design.

1 Claim, 7 Drawing Sheets

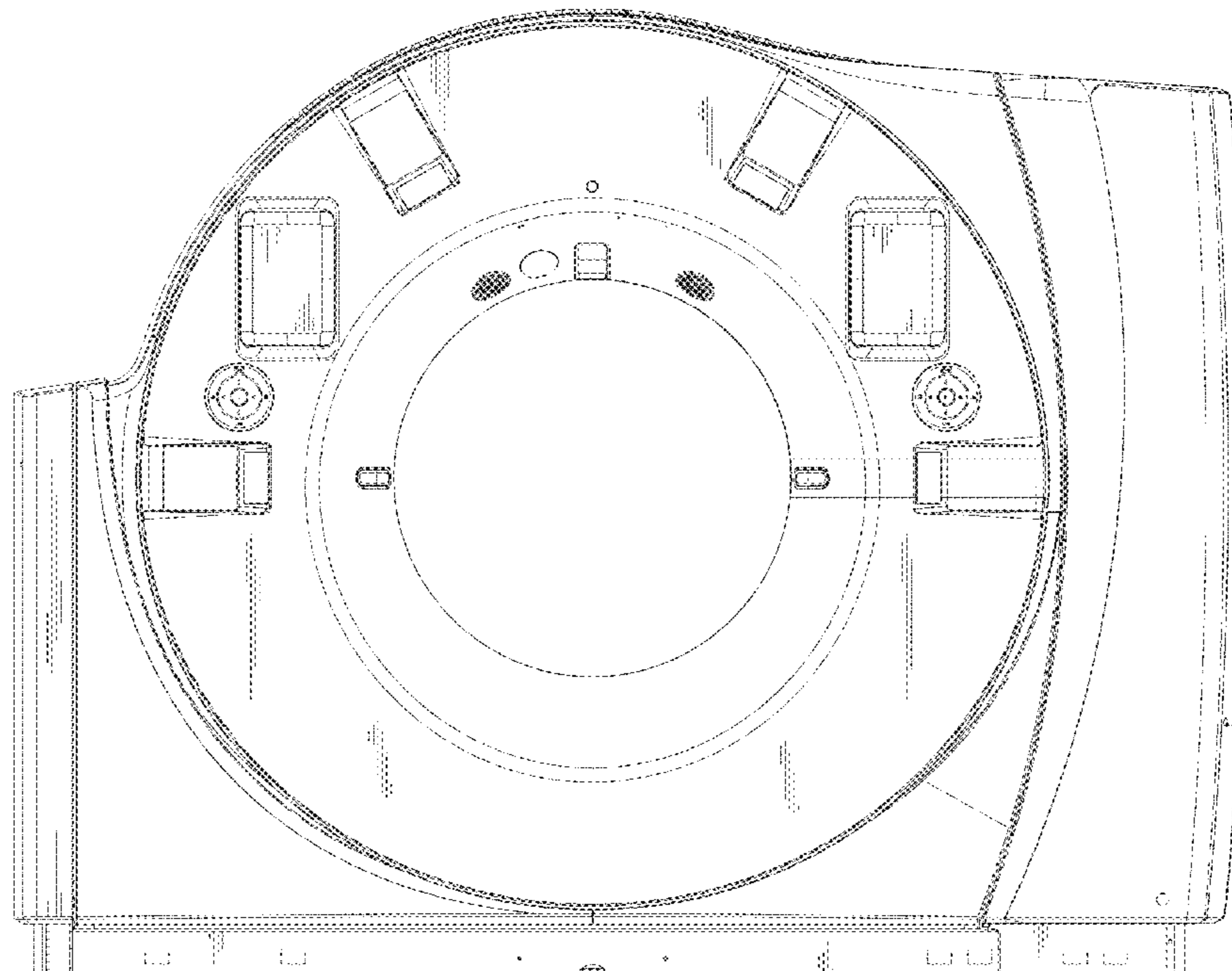

FIG. 1

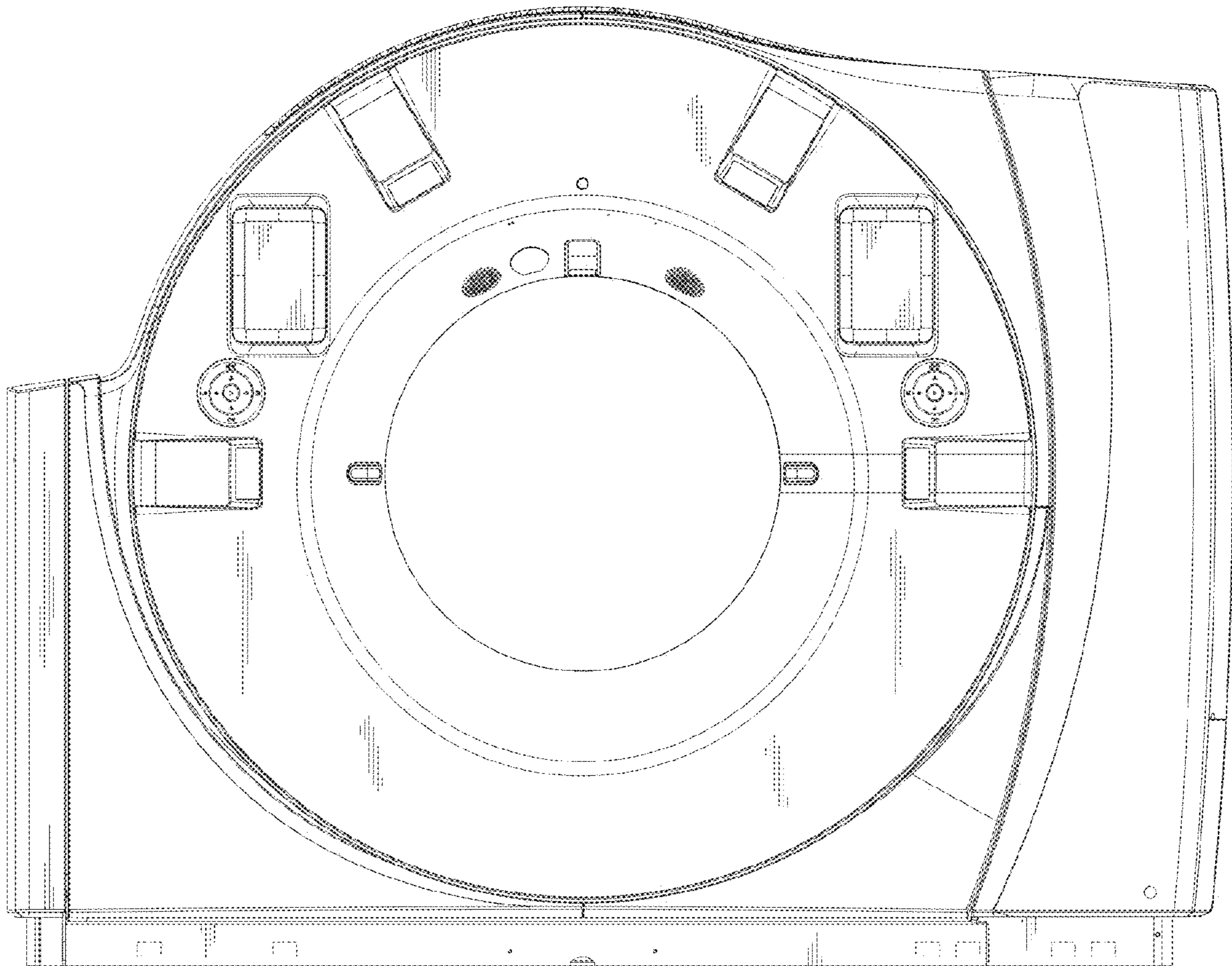

FIG. 2

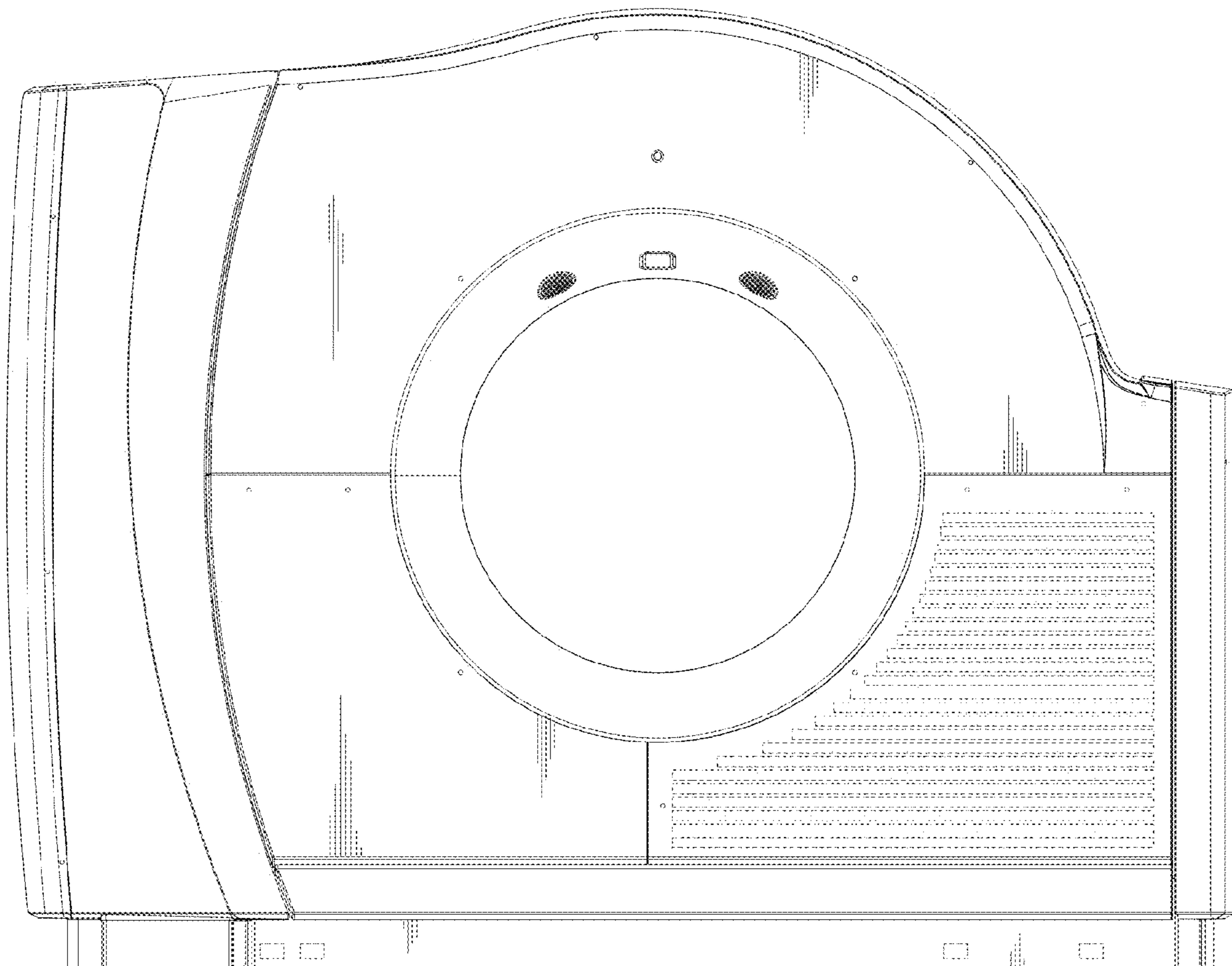

FIG. 3

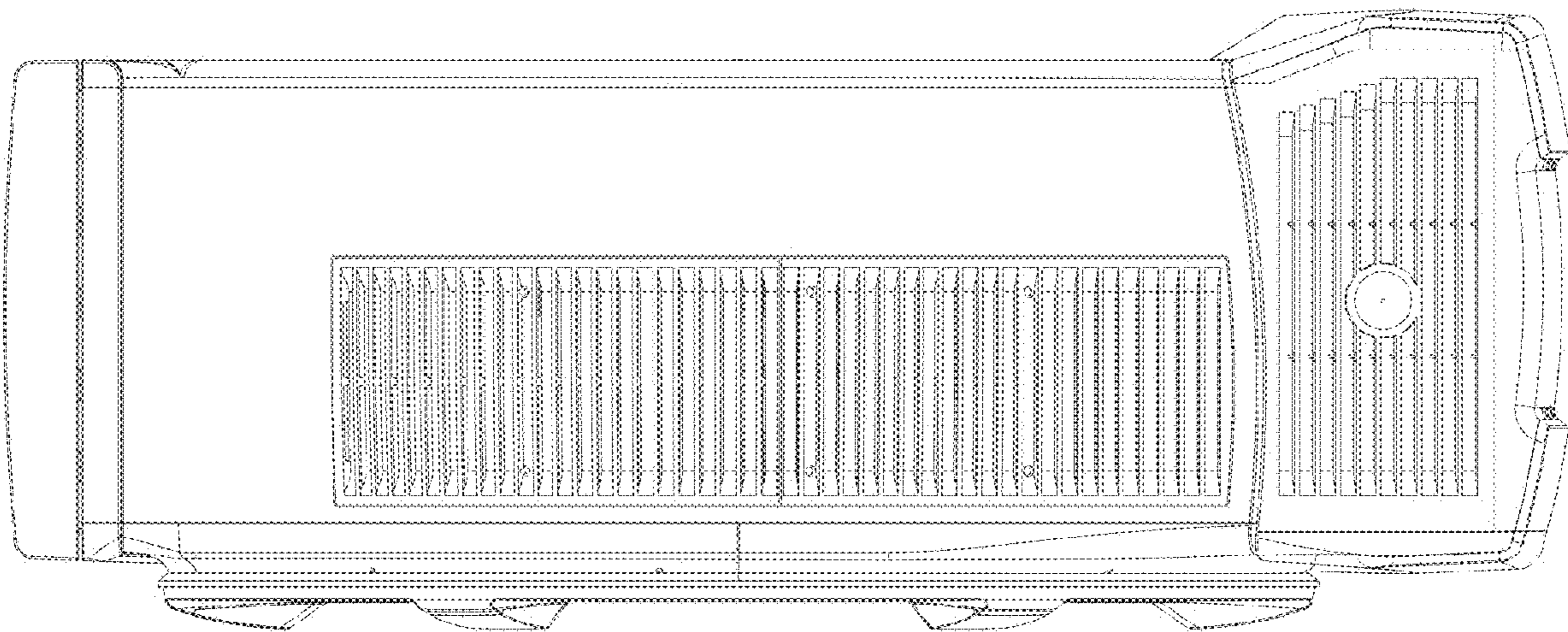

FIG. 4

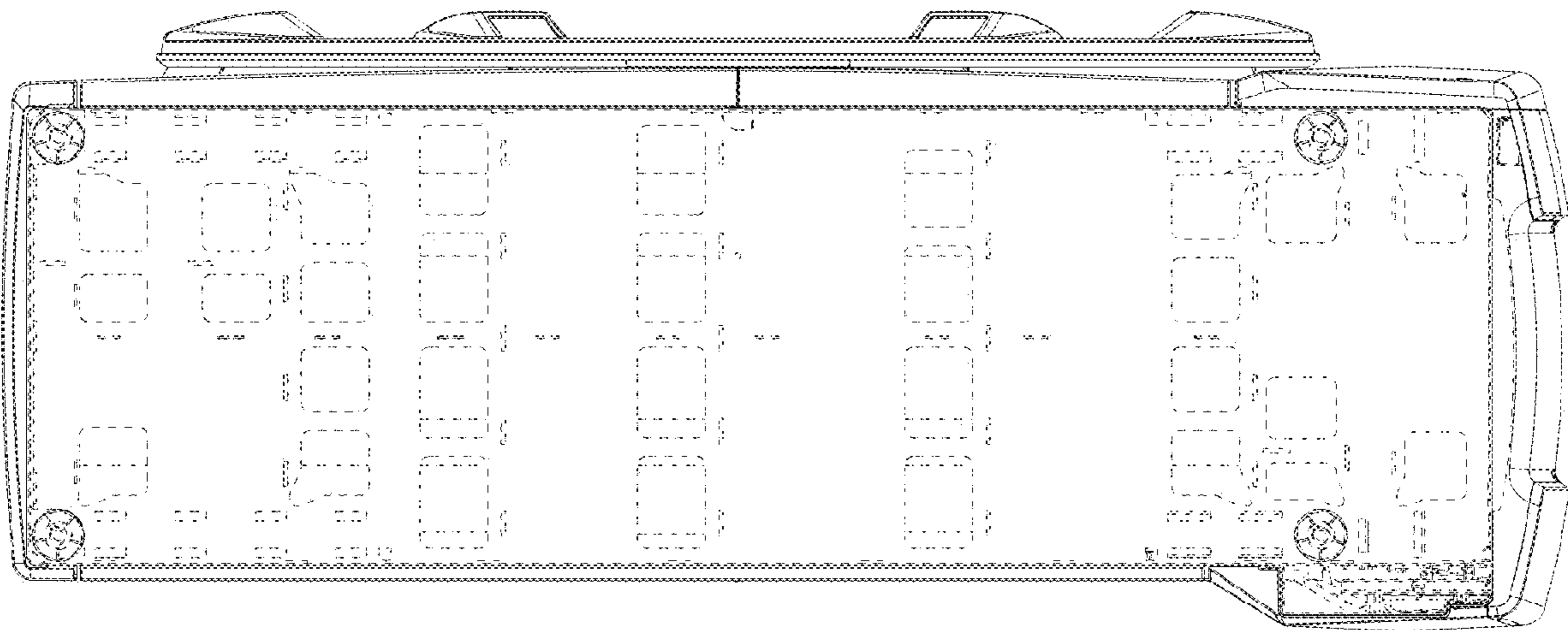

FIG. 5

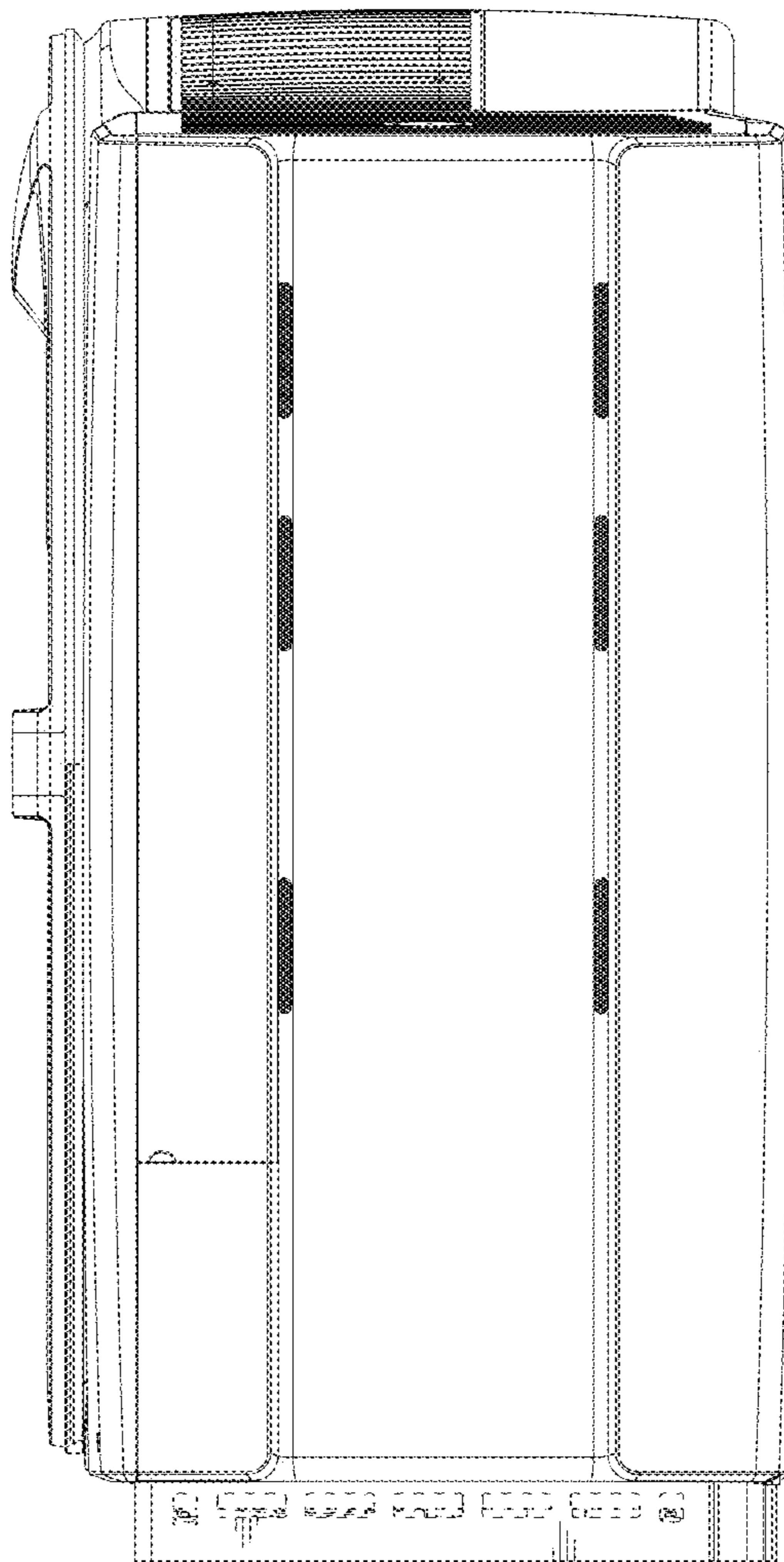

FIG. 6

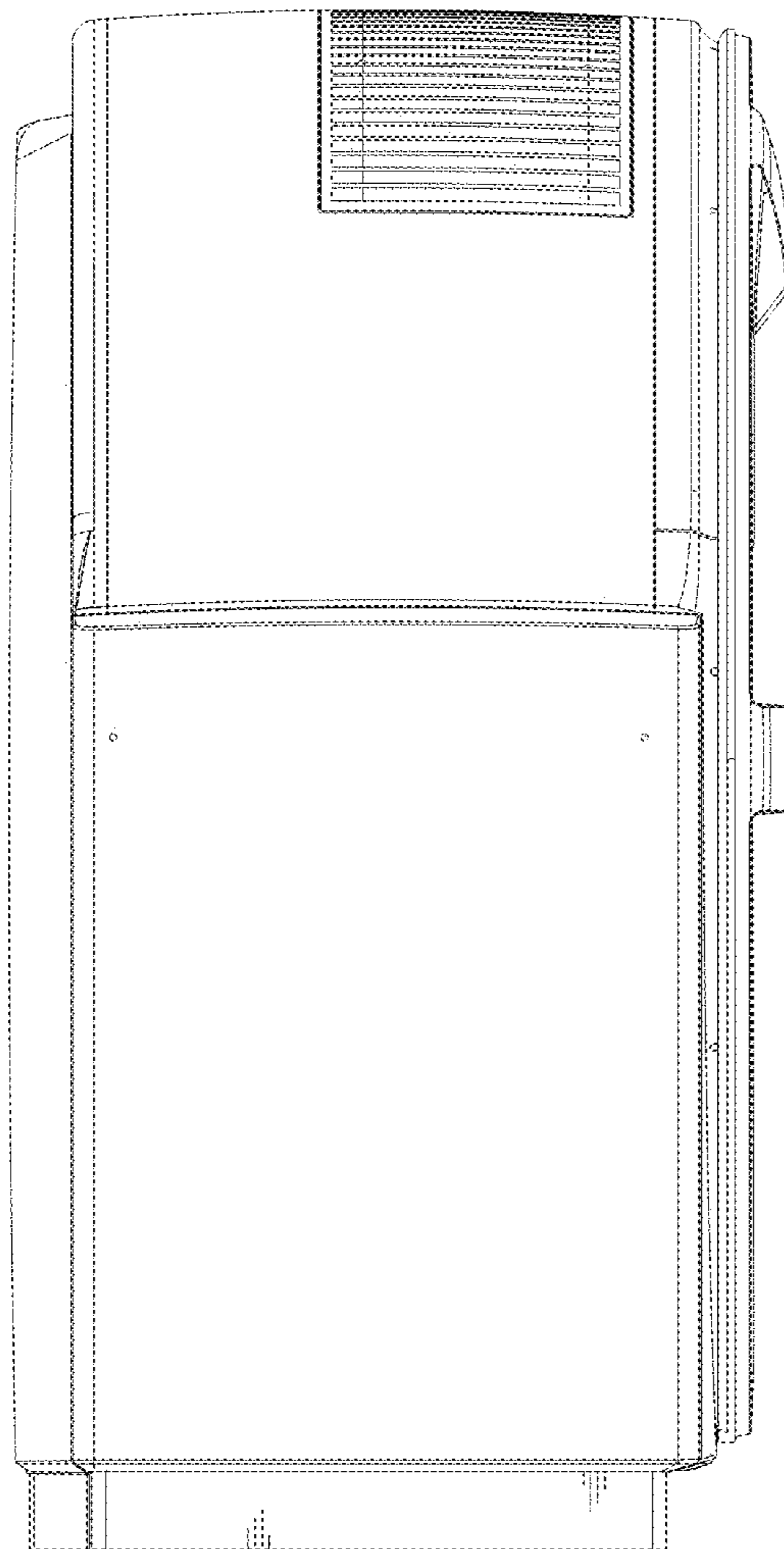

FIG. 7

