



US00D931371S

(12) **United States Design Patent**
Garfinkle

(10) **Patent No.:** **US D931,371 S**

(45) **Date of Patent:** **** Sep. 21, 2021**

(54) **COMBINED CURVED CARD HOLDER WITH TRAY CLIP**

(71) Applicant: **Benjamin Garfinkle**, Piedmont, CA (US)

(72) Inventor: **Benjamin Garfinkle**, Piedmont, CA (US)

(**) Term: **15 Years**

(21) Appl. No.: **29/754,231**

(22) Filed: **Oct. 8, 2020**

(51) **LOC (13) Cl.** **20-03**

(52) **U.S. Cl.**
USPC **D20/43**

(58) **Field of Classification Search**
USPC D6/325, 328; D8/321, 349, 354, 355, D8/366, 371, 380, 381; D20/10, 13, 17, D20/19, 29, 38, 39, 41, 42, 43, 99; D25/119

CPC G09F 7/00; G09F 7/02; G09F 7/16; G09F 9/00; G09F 9/3026; G09F 9/33; G09F 9/35; G09F 13/00; G09F 13/22; G09F 15/00; G09F 15/0056; G09F 15/0068; G06F 3/14; H01R 13/514

See application file for complete search history.

(56) **References Cited**

U.S. PATENT DOCUMENTS

- D128,793 S * 8/1941 Bonnell D25/119
- 2,679,846 A * 6/1954 Addison B42F 21/08 40/360
- D382,977 S * 8/1997 Gearing D25/119
- D446,249 S * 8/2001 Bjerke D20/44
- D485,313 S * 1/2004 Healy D20/43
- D513,280 S * 12/2005 Kosir D20/44

- D522,297 S * 6/2006 Miller D6/580
- D536,954 S * 2/2007 Sjoberg D8/373
- D546,104 S * 7/2007 Miller D6/580
- D552,687 S * 10/2007 Smalley D20/44
- D573,267 S * 7/2008 Brinton D25/119
- D573,268 S * 7/2008 Lundsgaard D25/119
- D614,239 S * 4/2010 Garfinkle D20/44
- D614,241 S * 4/2010 Garfinkle D20/44
- D616,946 S * 6/2010 Garfinkle D20/43
- D656,196 S * 3/2012 Gross D20/10
- D690,366 S * 9/2013 Bouwhuis D20/43
- D696,205 S * 12/2013 Woodlief D13/155
- D759,758 S * 6/2016 Garfinkle D20/43
- D807,570 S * 1/2018 Klus D26/138
- D855,702 S * 8/2019 Garfinkle D20/43
- D869,075 S * 12/2019 Trzecielski D26/138
- 2009/0064554 A1 * 3/2009 Alves G09F 3/204 40/652

* cited by examiner

Primary Examiner — Mary Ann Calabrese

Assistant Examiner — Catherine Ho

(74) *Attorney, Agent, or Firm* — Nathan Koenig

(57) **CLAIM**

I claim the ornamental design for a combined curved card holder with tray clip, as shown and described.

DESCRIPTION

FIG. 1 is a perspective view of a combined curved card holder with tray clip, showing my new design;
 FIG. 2 is a left side view of FIG. 1;
 FIG. 3 is a right side view of FIG. 1;
 FIG. 4 is a front view of FIG. 1;
 FIG. 5 is a back view of FIG. 1;
 FIG. 6 is a bottom view of FIG. 1; and,
 FIG. 7 is a top view of FIG. 1.

1 Claim, 2 Drawing Sheets

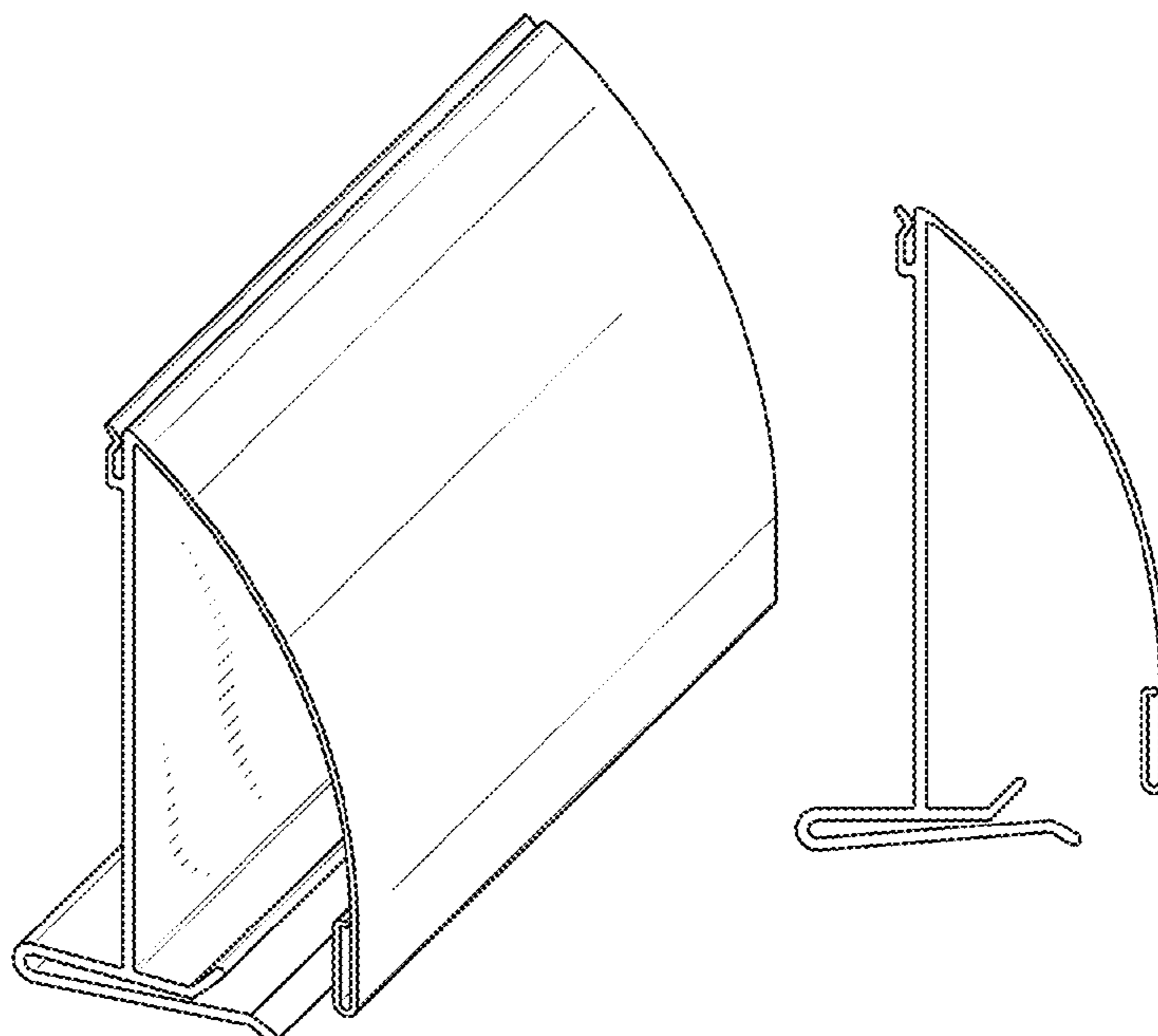

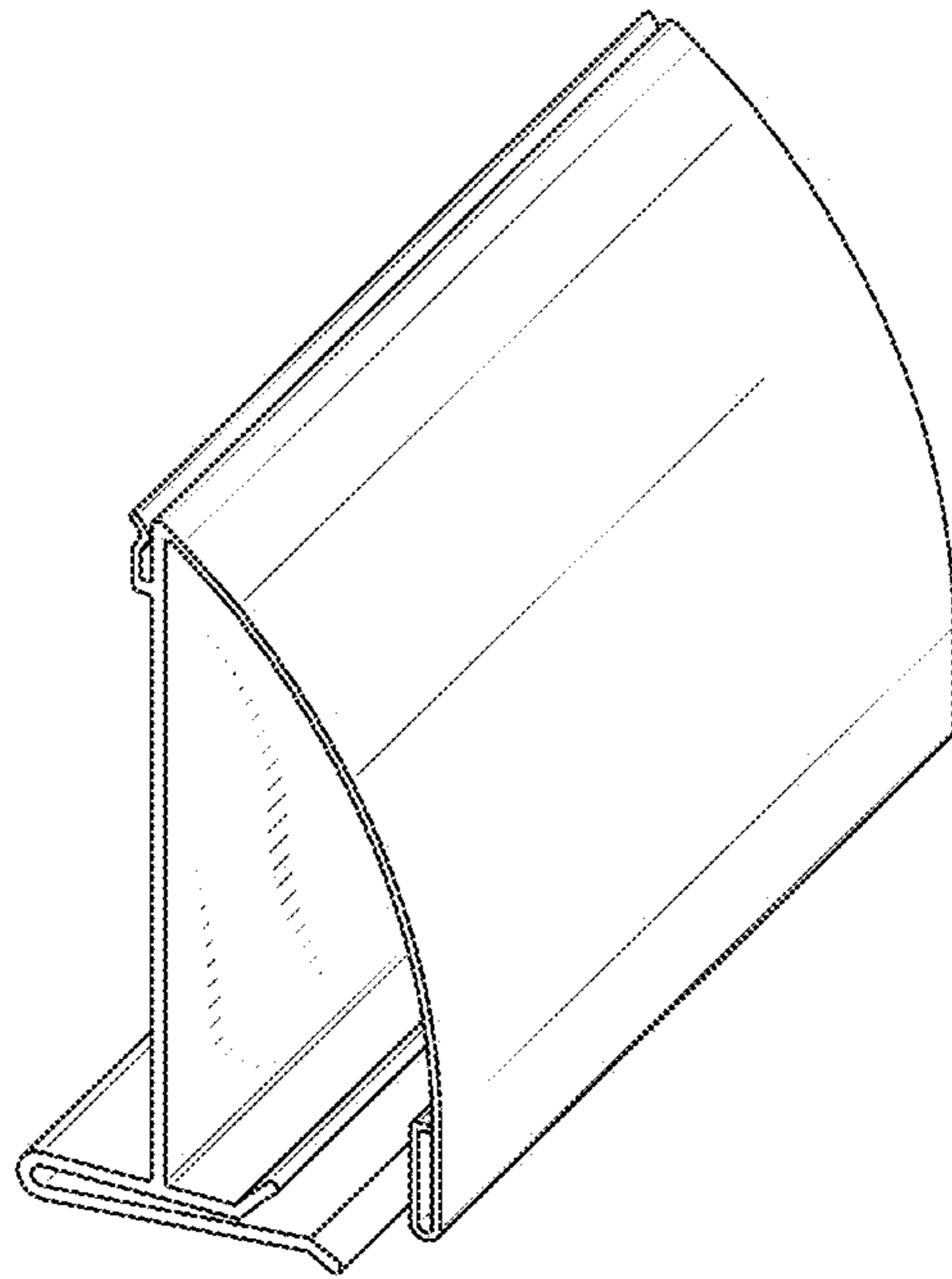

FIG. 1

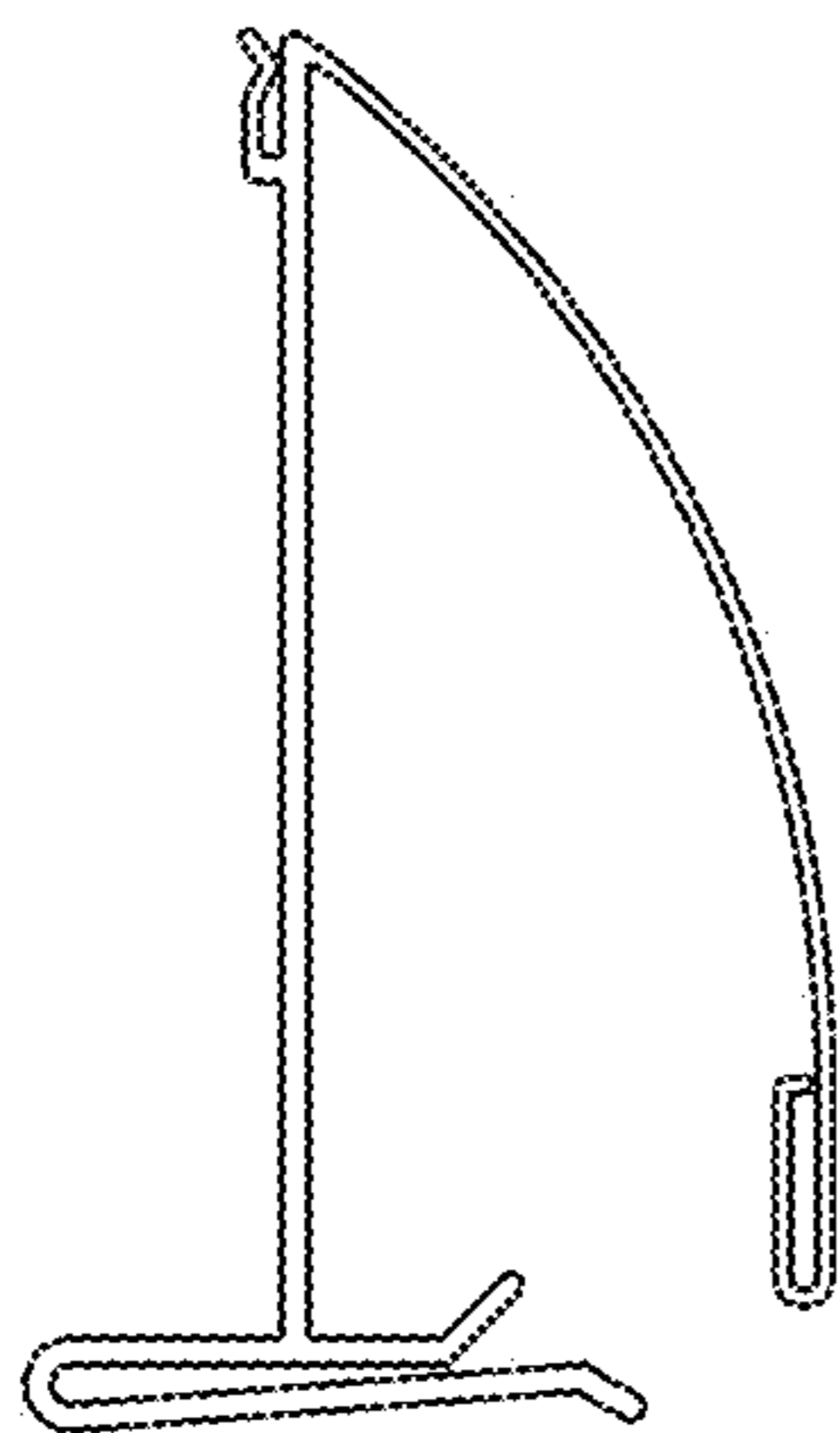

FIG. 2

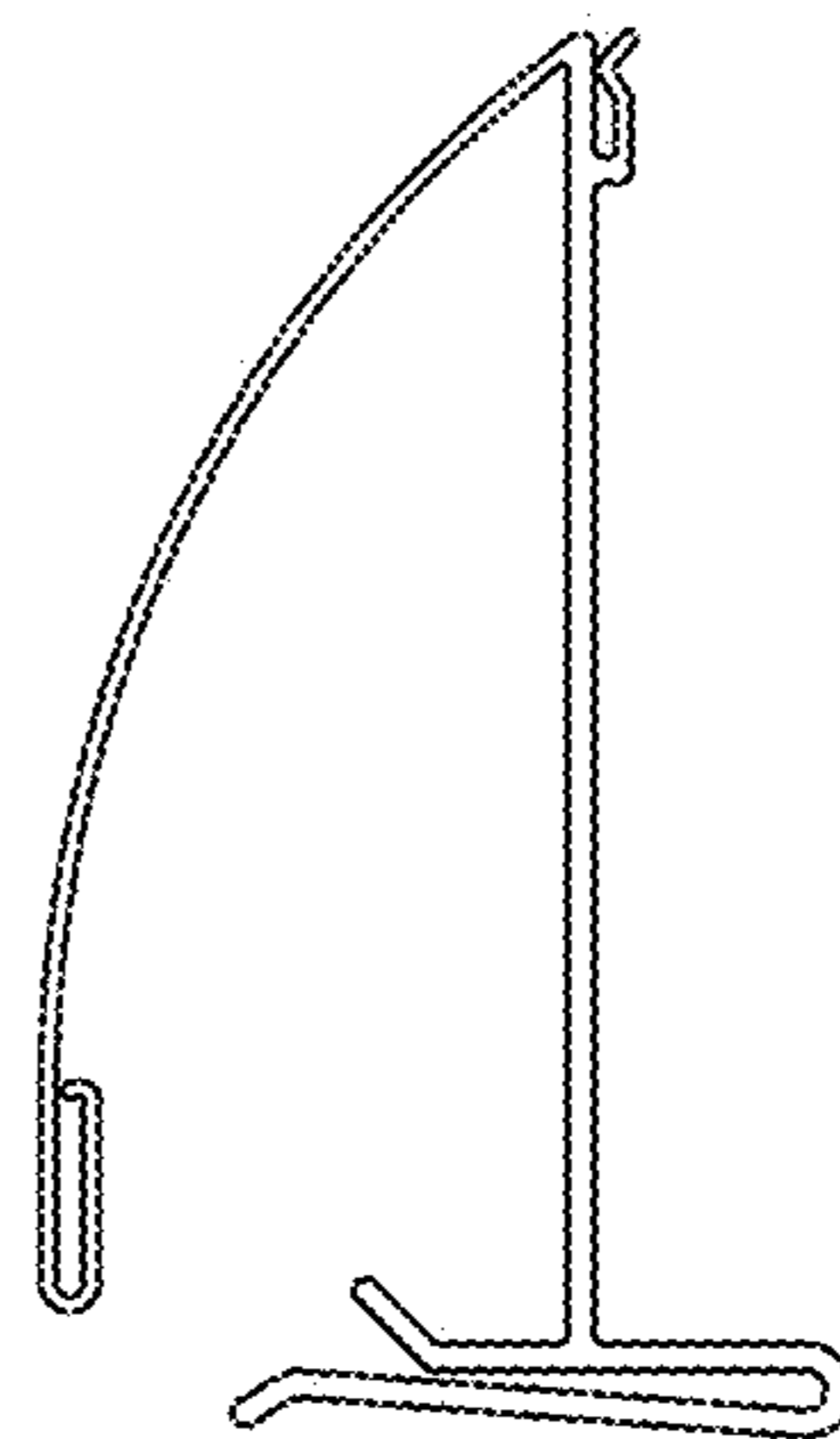

FIG. 3

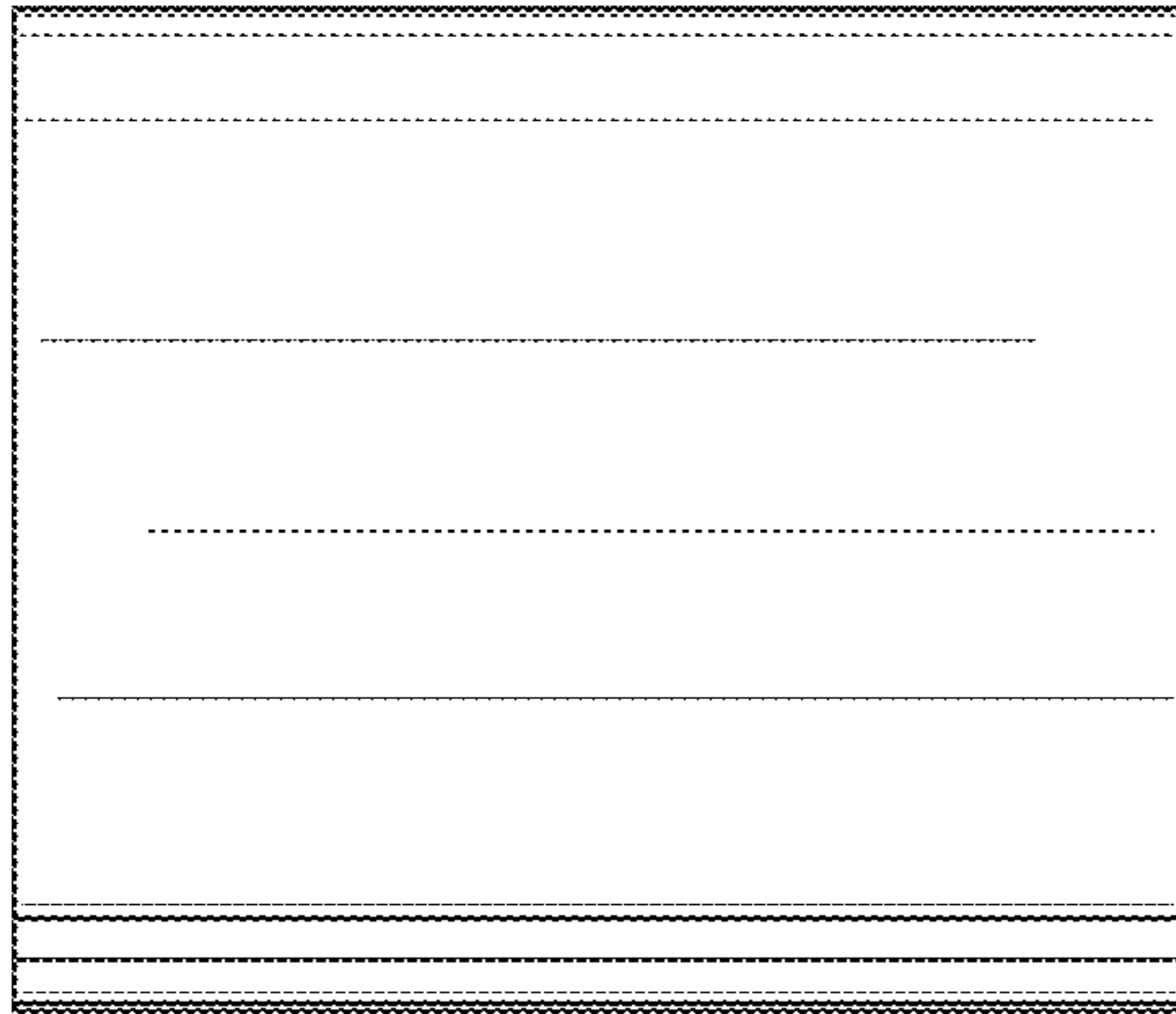

FIG. 4

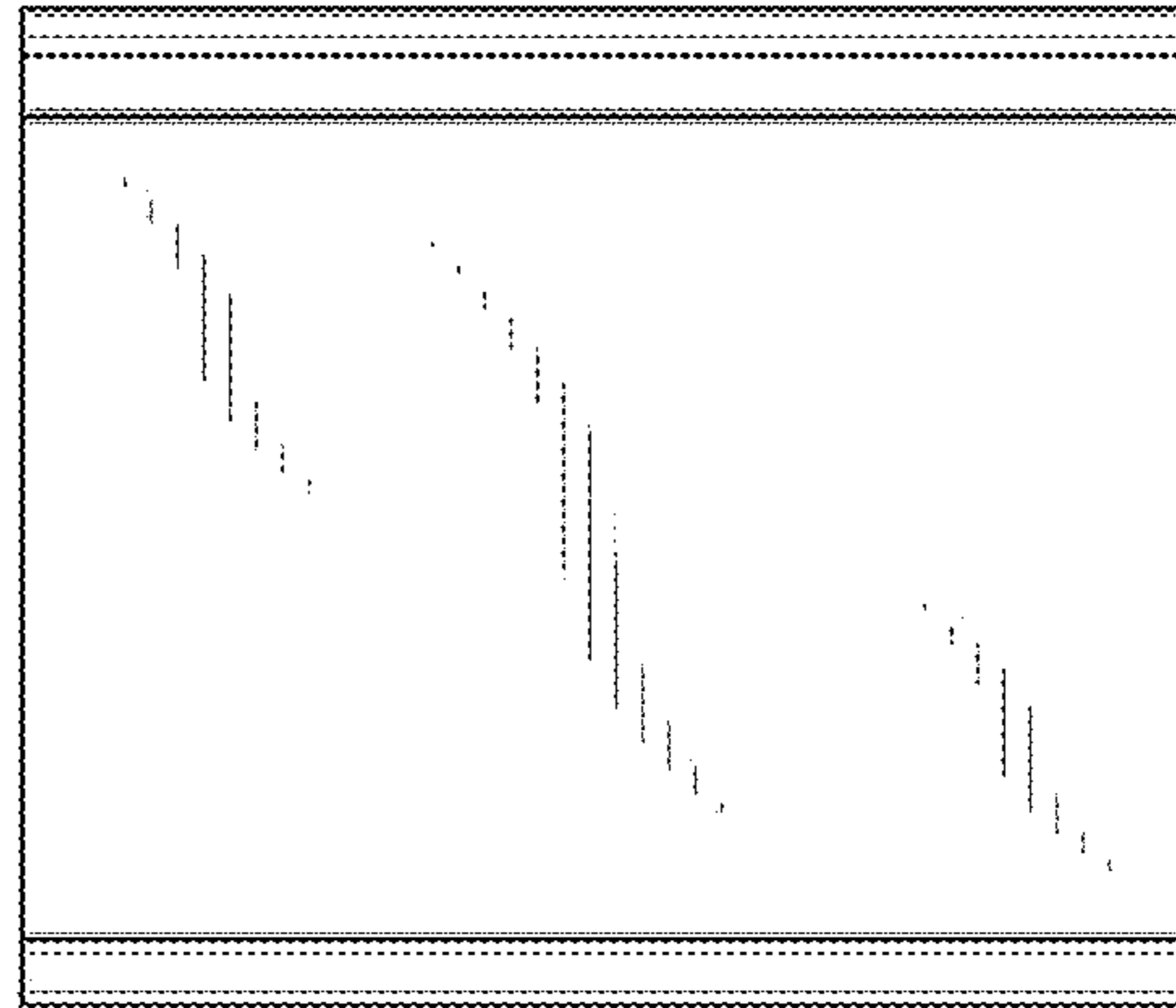

FIG. 5

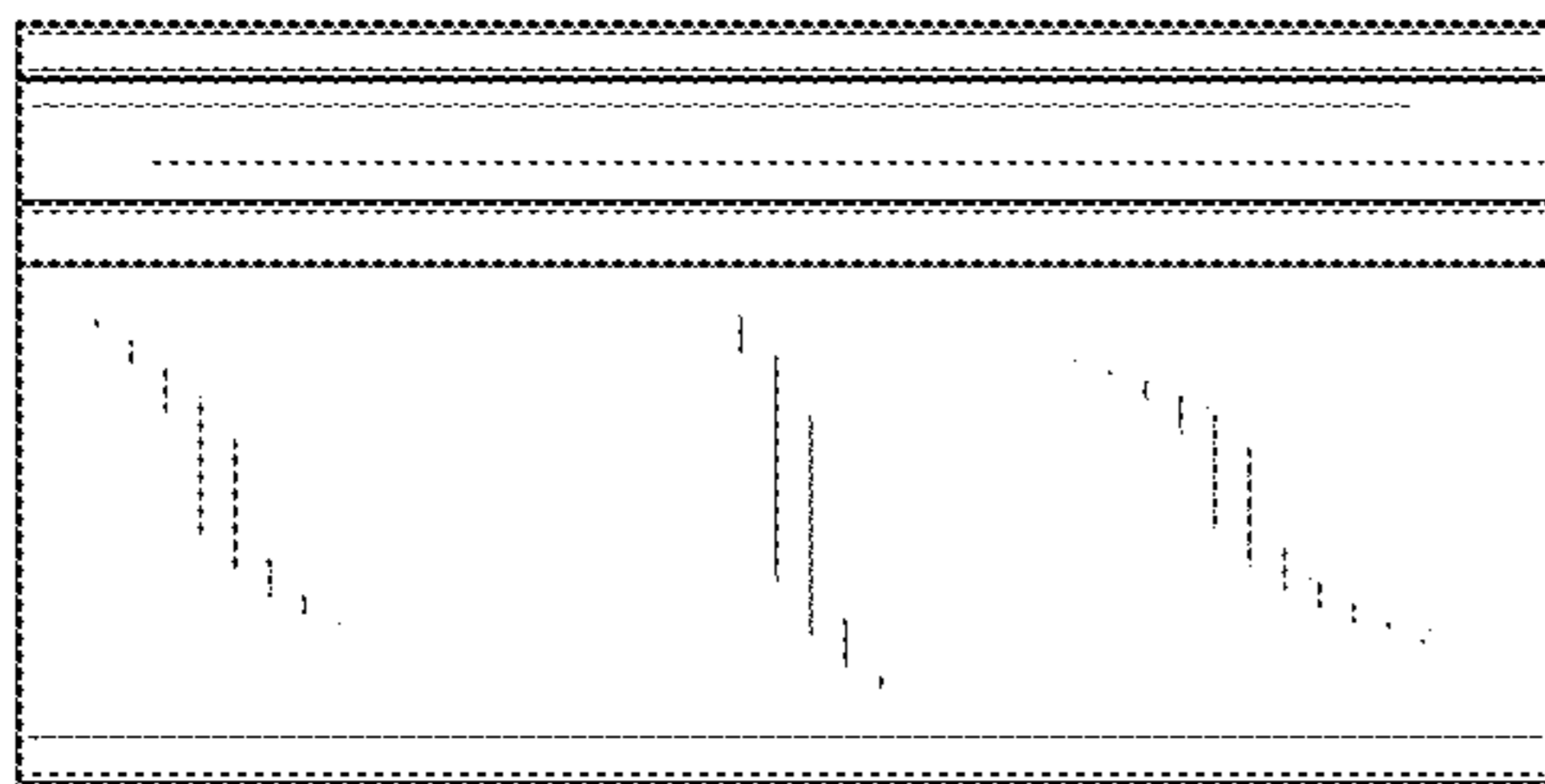

FIG. 6

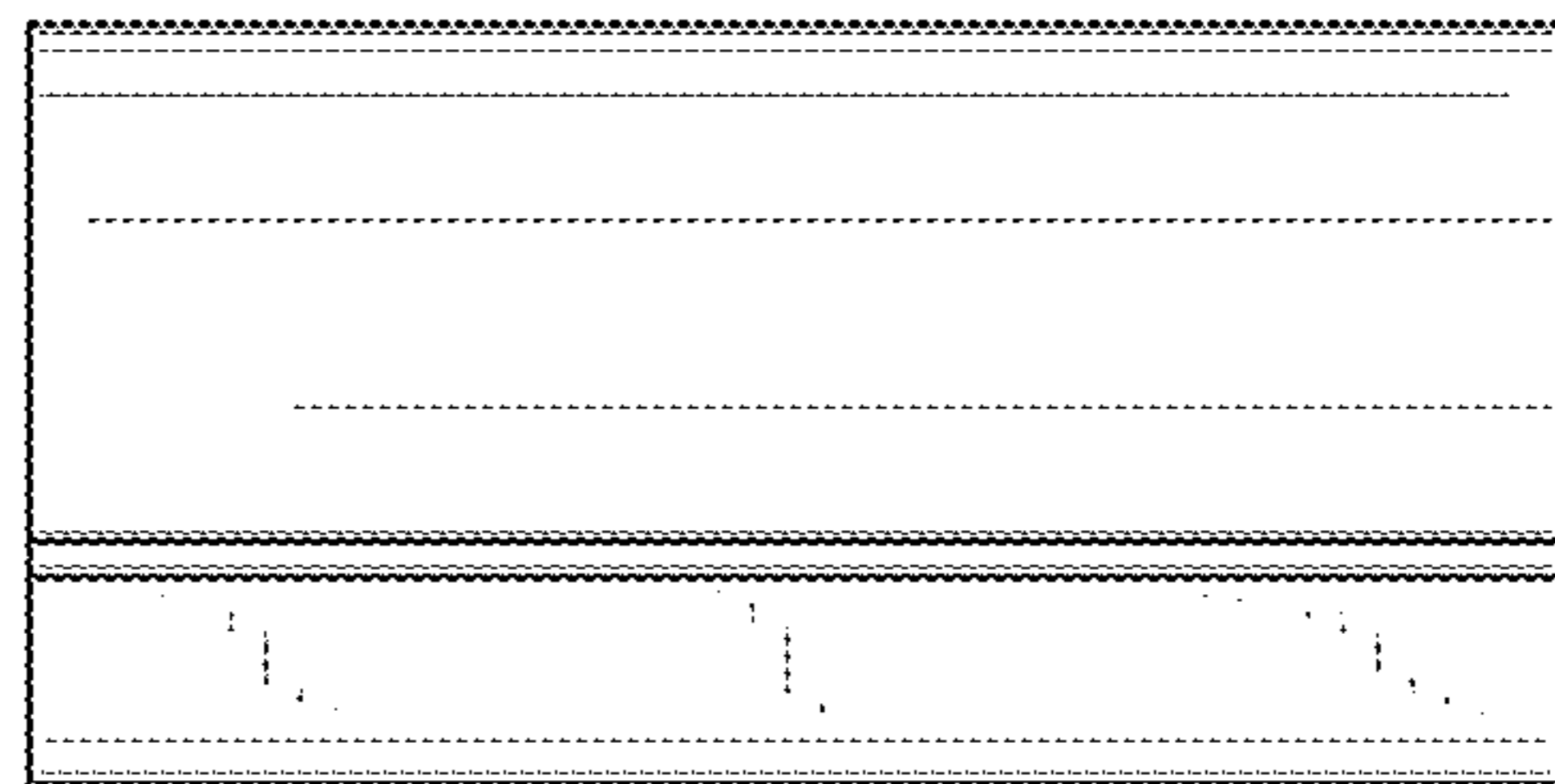

FIG. 7