



US00D931355S

(12) **United States Design Patent** (10) **Patent No.:** **US D931,355 S**
Aggarwal et al. (45) **Date of Patent:** **** *Sep. 21, 2021**

(54) **360 DEGREE STEREO SINGLE SENSOR CAMERA**

(56) **References Cited**

(71) Applicant: **DreamVu, Inc.**, Philadelphia, PA (US)

D435,576 S * 12/2000 McBride D16/203

(72) Inventors: **Rajat Aggarwal**, Ludhiana (IN);
Arunraj Janakiraman, Villupuram (IN);
Jasmin Jayendra Joshi, Rajkot (IN);
Sri Naga Sai Harsha Ch, Machilipatnam (IN)

D435,577 S * 12/2000 McBride D16/203

6,795,109 B2 9/2004 Peleg et al.

6,812,970 B1 * 11/2004 McBride G08B 13/19619

348/151

8,520,138 B1 8/2013 Seale

D689,220 S * 9/2013 Zhang D26/2

(Continued)

FOREIGN PATENT DOCUMENTS

(73) Assignee: **DREAMVU, INC.**, Lafayette, CA (US)

CN 104777835 A 7/2015

(*) Notice: This patent is subject to a terminal disclaimer.

DE 202017104934 U1 11/2017

(Continued)

(**) Term: **15 Years**

OTHER PUBLICATIONS

(21) Appl. No.: **29/640,341**

Afshari et al. Hardware implementation of an omnidirectional camera with real-time 3D imaging capability. IEEE Xplore. 3DTV Conference: The True Vision—Capture, Transmission and Display of 3D Video (3DTV-CON), Jun. 2011. 4 pages.

(22) Filed: **Mar. 14, 2018**

(Continued)

(30) **Foreign Application Priority Data**

Feb. 27, 2018 (IN) 303030

Primary Examiner — Ramzi Almatrahi

(51) **LOC (13) Cl.** **16-01**

(74) *Attorney, Agent, or Firm* — Wilson Sonsini Goodrich & Rosati

(52) **U.S. Cl.**
USPC **D16/203**

(57) **CLAIM**

(58) **Field of Classification Search**
USPC D16/200, 202–206, 218, 219, 242;
D26/1–3; 313/315, 318.01; 348/143,
348/148, 151, 373–376; 396/419, 427,
396/535, 539–541
CPC G03B 17/02; G03B 19/04; G03B 17/56;
G03B 17/04; G03B 15/03; H04N 5/2251;
H04N 5/2252; H04N 5/2253; H04N
5/2254; H04N 7/181; H04N 7/183; H04N
7/18; G08B 13/1963; G08B 13/19619;
G08B 13/19632

The ornamental design for a 360 degree stereo single sensor camera, as shown.

DESCRIPTION

See application file for complete search history.

FIG. 1 is a front view of a 360 degree stereo single sensor camera showing our new design;
FIG. 2 is a back view thereof;
FIG. 3 is a top view thereof;
FIG. 4 is a bottom view thereof;
FIG. 5 is a left side view thereof;
FIG. 6 is a right side view thereof; and,
FIG. 7 is a perspective view thereof.

1 Claim, 7 Drawing Sheets

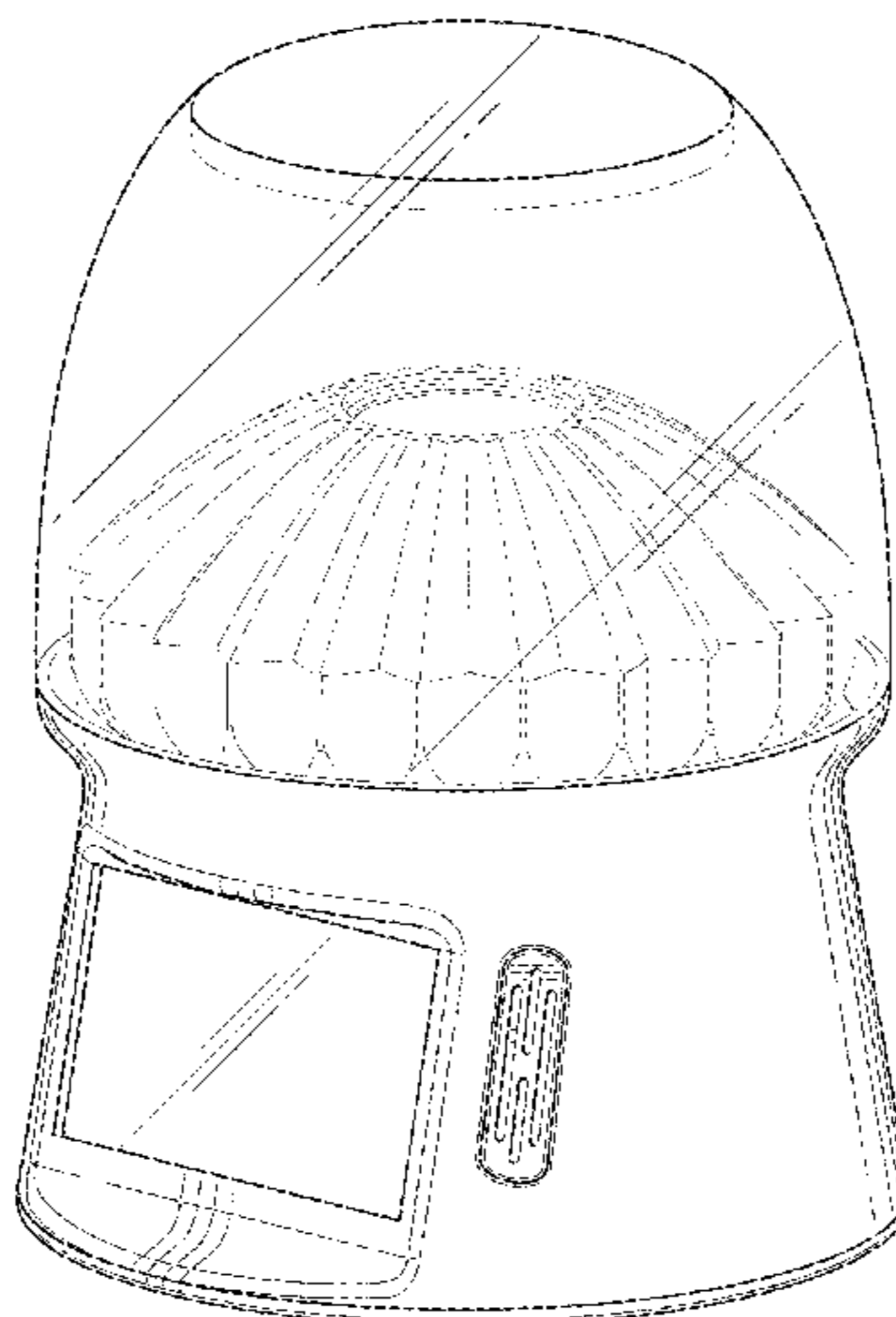

(56)

References Cited

U.S. PATENT DOCUMENTS

8,548,269	B2	10/2013	Zargarpour et al.	
D705,334	S *	5/2014	Fransson	D16/203
D740,873	S *	10/2015	Scalisi	D16/203
D749,161	S *	2/2016	Scalisi	D16/203
D768,223	S *	10/2016	Wu	D16/203
D813,290	S *	3/2018	Song	D16/203
9,930,225	B2	3/2018	Villmer et al.	
D836,148	S *	12/2018	Jeong	D16/203
10,154,249	B2	12/2018	Namboodiri et al.	
2001/0038413	A1	11/2001	Peleg et al.	
2003/0220971	A1	11/2003	Kressin et al.	
2004/0001138	A1	1/2004	Weerashinghe et al.	
2004/0263611	A1	12/2004	Cutler et al.	
2014/0104378	A1	4/2014	Kauff et al.	
2015/0341557	A1	11/2015	Chapdelaine-Couture et al.	
2016/0295108	A1	10/2016	Cao	
2016/0352982	A1	12/2016	Weaver et al.	
2016/0353090	A1	12/2016	Esteban et al.	
2017/0142337	A1	5/2017	Kokaram et al.	
2017/0347044	A1	11/2017	Douady-Pleven et al.	
2017/0363949	A1	12/2017	Valente et al.	
2018/0208311	A1	7/2018	Zhang et al.	
2018/0220156	A1	8/2018	Kim	
2018/0324355	A1	11/2018	Wang	
2019/0349567	A1	11/2019	Aggarwal et al.	

FOREIGN PATENT DOCUMENTS

EP	2428036	B1	9/2015
IN	201627038877	A	12/2016
IN	201847001601	A	2/2018
KR	100960781	B1	6/2010
KR	20170109297	A	9/2017
WO	WO-2019161289	A1	8/2019

OTHER PUBLICATIONS

Aggarwal et al. Panoramic Stereo Videos Using A Single Camera. IEEE Conference on Computer Vision & Pattern Recognition (CVPR). IEEE Xplore; Dec. 12, 2016.

Anderson et al. JUMP: Virtual reality video. ACM Transactions on Graphics, 35(6):1-13. Nov. 2016.

Co-pending U.S. Appl. No. 29/640,347, filed Mar. 14, 2018.

Fingas, Jon. Samsung's 360 Round camera livestreams 3D VR. Engadget.com. Product review published Oct. 18, 2017. 1 page. URL:< <https://www.engadget.com/2017/10/18/samsung-360-round-vr-camera/>.

FLIR. Accurate 360° Spherical Imaging With Multiple Pre-Calibrated Sensors. FLIR White Paper Series. Web Product Brochure. Published on May 4, 2015; FLIR Integrated Imaging Solutions, Inc. 3 pages. URL:< <https://www.ptgrey.com/Whitepaper/360-spherical-precalibrated-cameras>.

Gurrieri et al. Stereoscopic cameras for the real-time acquisition of panoramic 3D images and videos. Proceedings of SPIE—The International Society for Optical Engineering 8648:1-17, Mar. 2013.

Nokia. OZO Technologies. Web product brochure. © 2018 Nokia. Printed Feb. 13, 2019. 7 pages. URL: <https://ozo.nokia.com/>.

Occam Vision Group. Omni Stereo—Omnidirectional camera, panoramic video and depth. Web product brochure. Occam Vision Group. Accessed Feb. 13, 2019. URL:<<http://occamvisiongroup.com/product/omni-stereo/>>.

PCT/US19/18332 International Search Report dated Jun. 18, 2019.

Statt, Nick. Facebook's new Surround 360 video cameras let you move around inside live-action scenes. The Verge.com; Vox Media, Inc.; Published Apr. 19, 2017. 6 pages. URL:<<https://www.theverge.com/2017/4/19/15345738/facebook-surround-360-video-cameras-f8-conference-2017>>.

U.S. Appl. No. 16/277,521 Office Action dated Jan. 30, 2020.

* cited by examiner

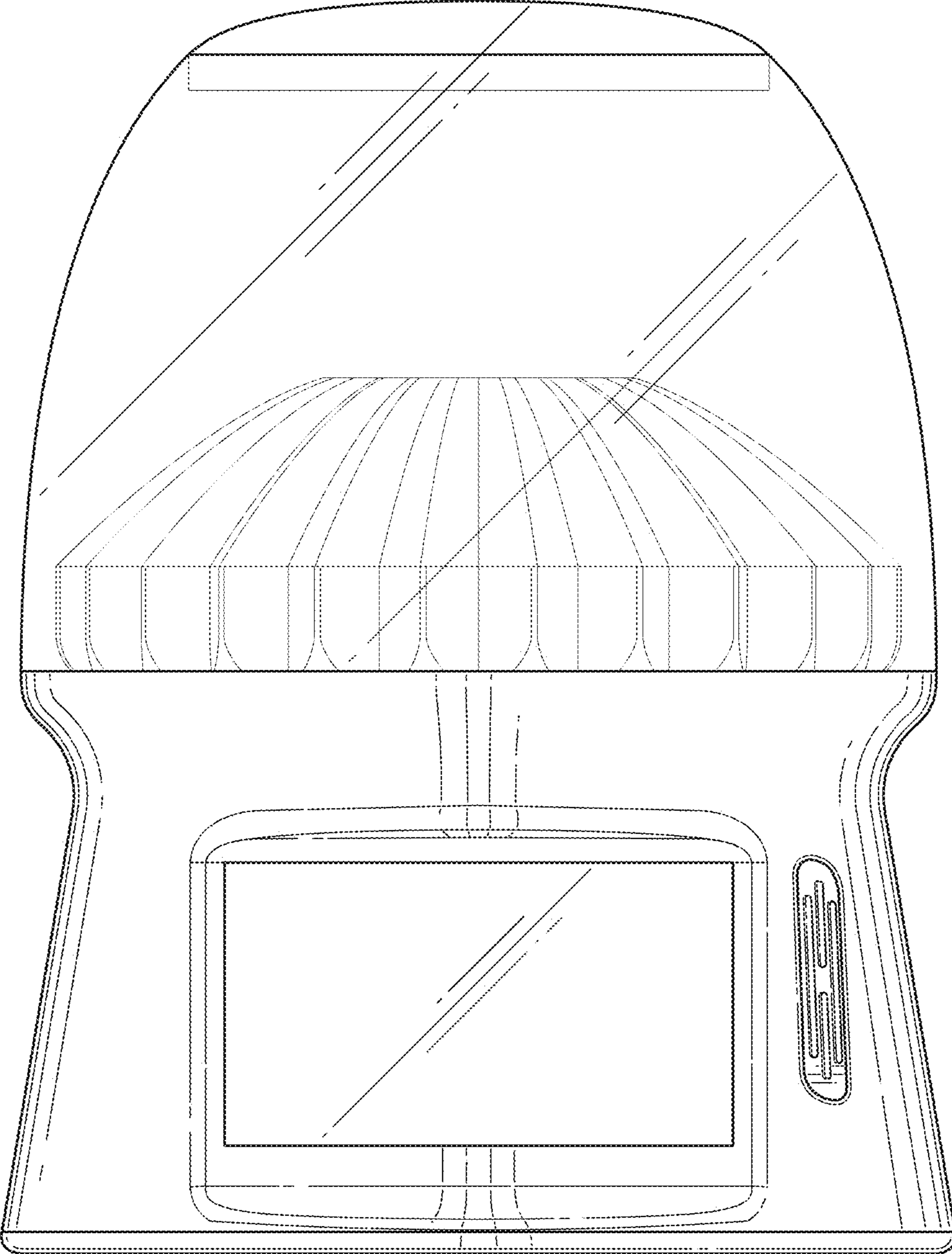

FIG. 1

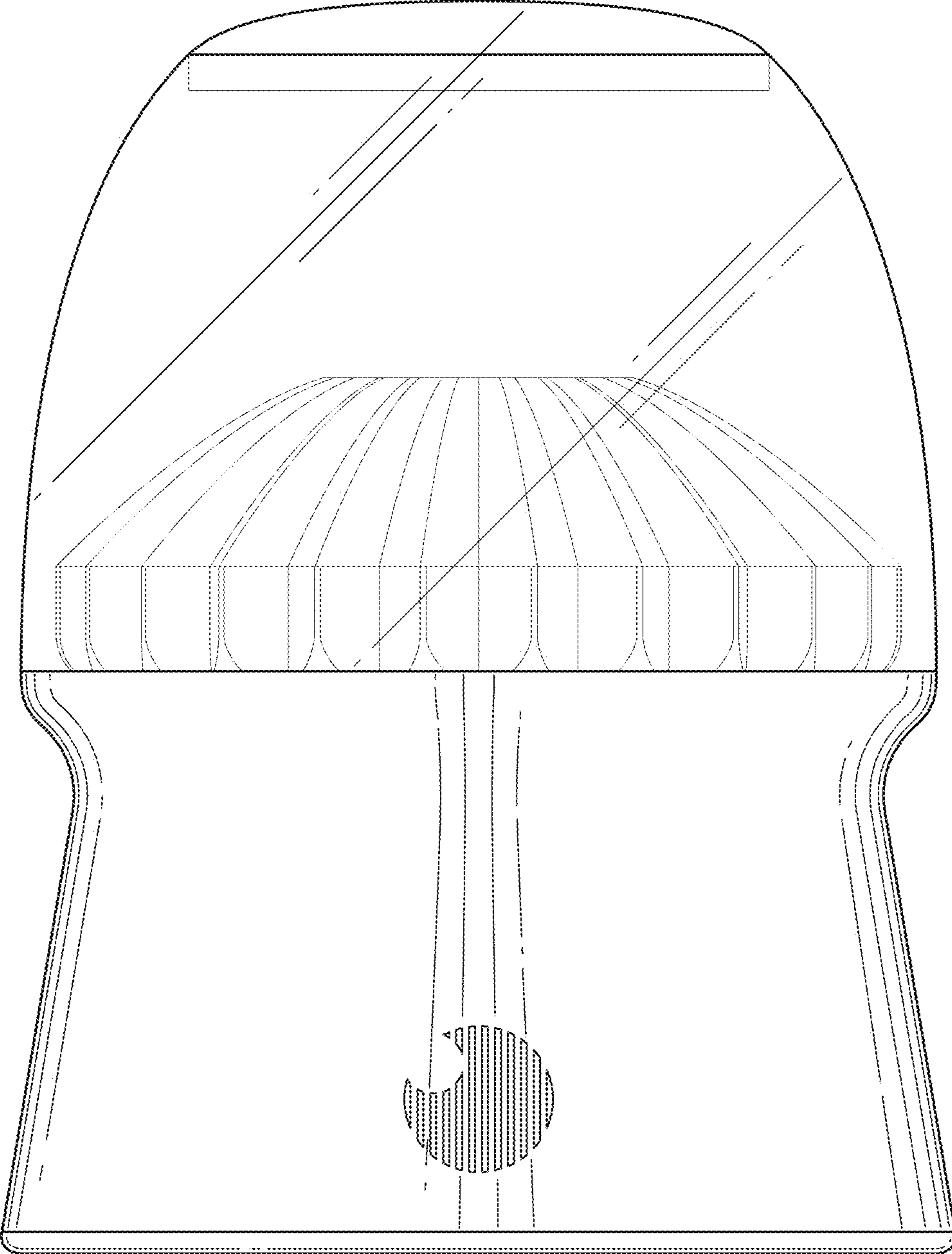

FIG. 2

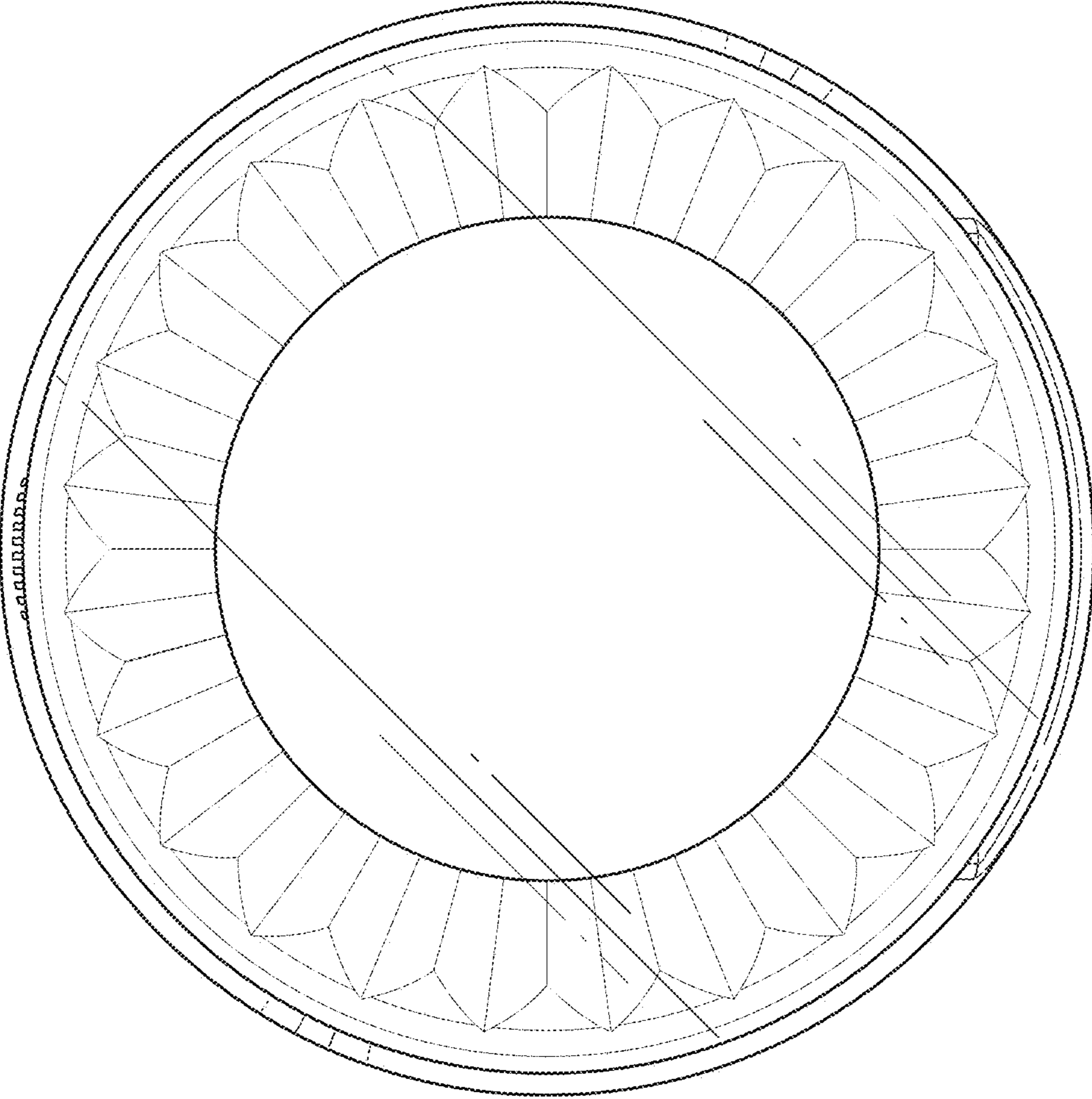

FIG. 3

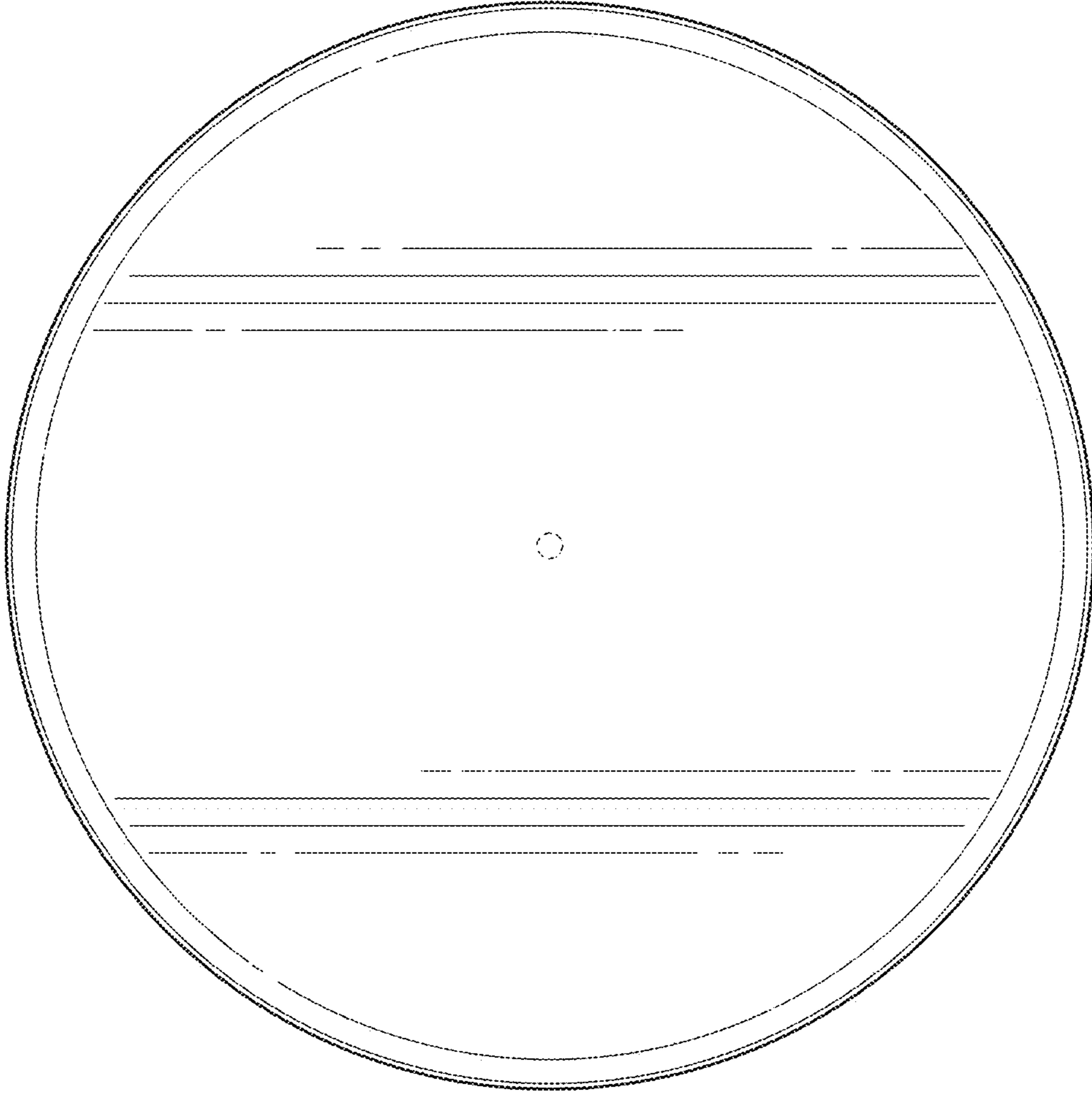

FIG. 4

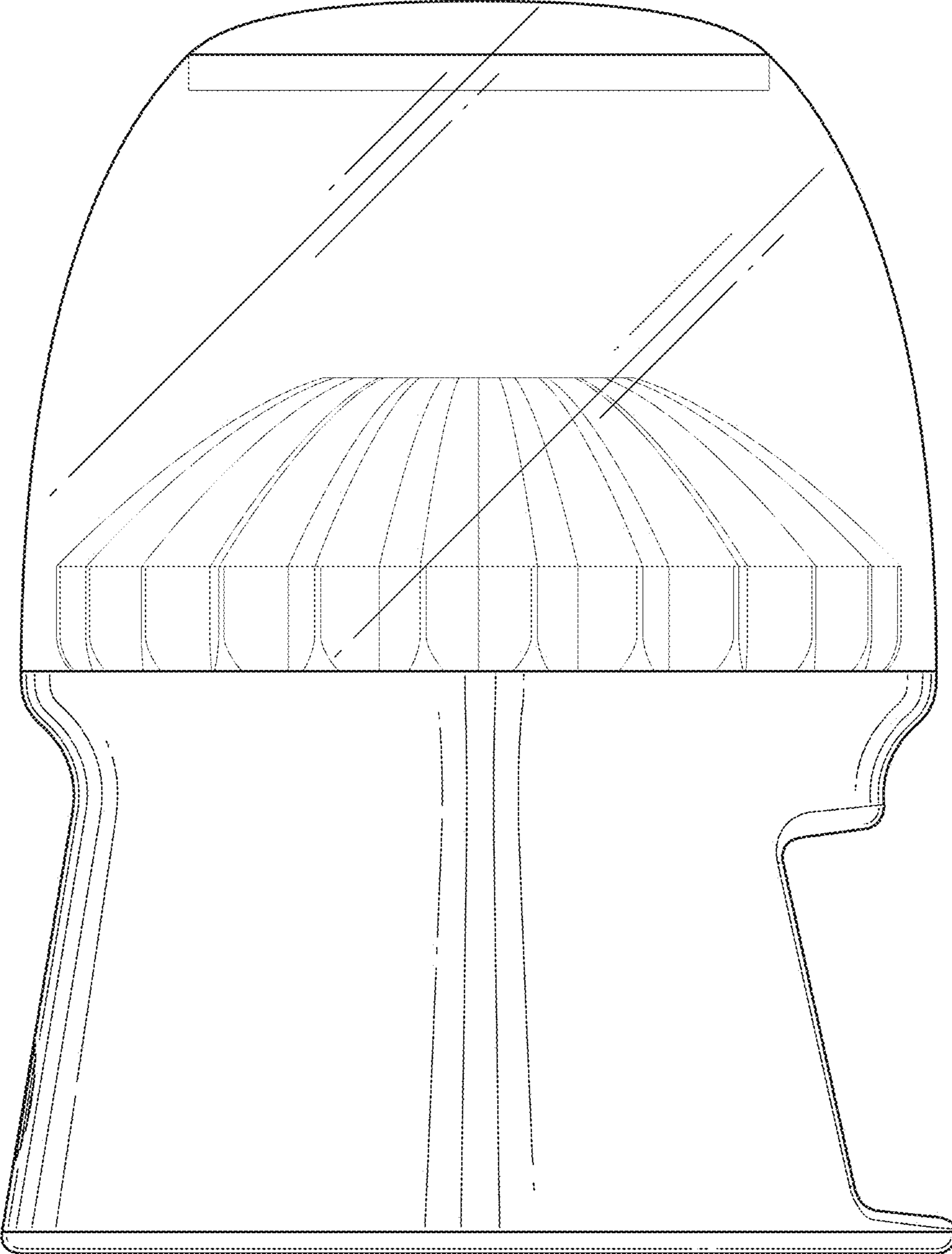

FIG. 5

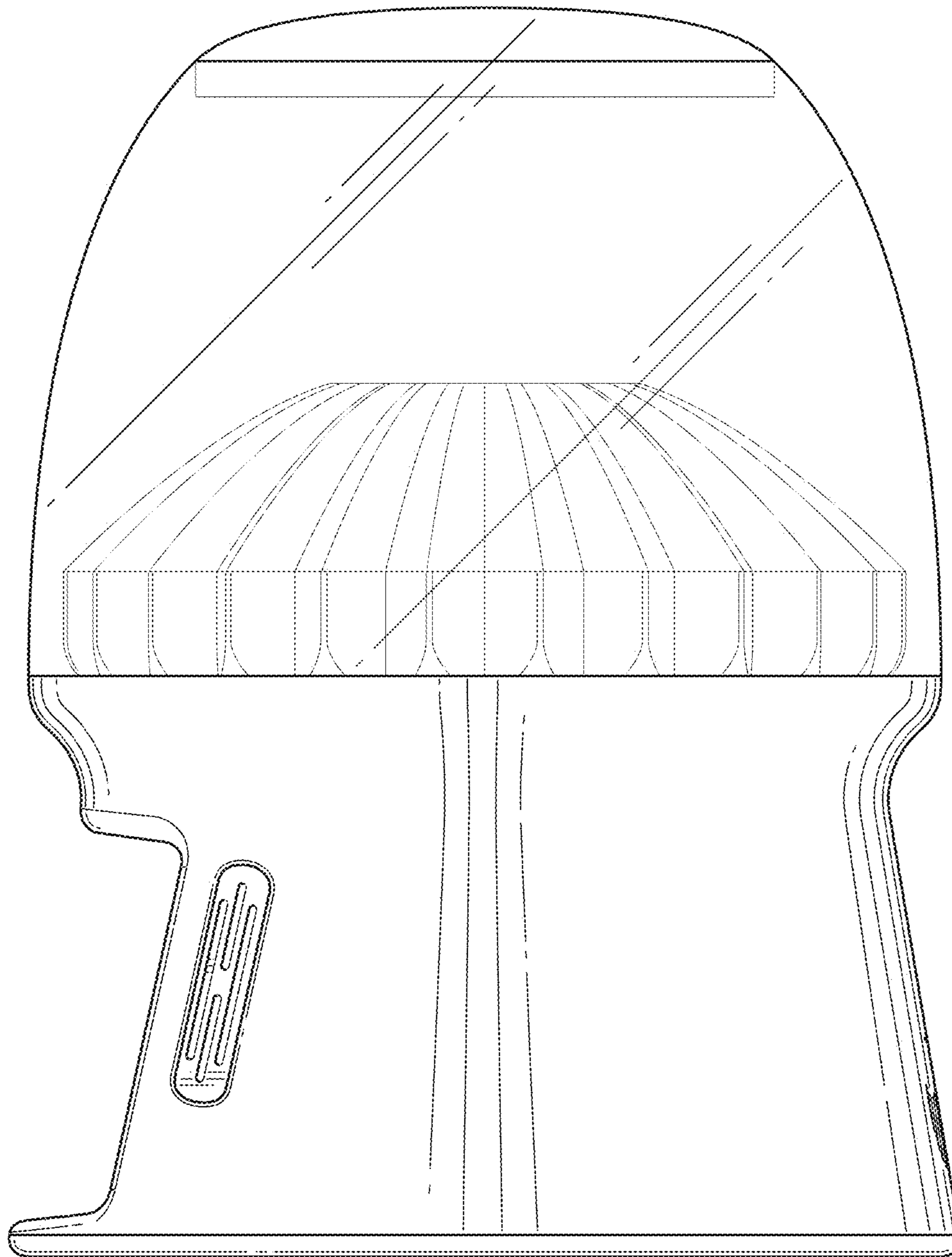

FIG. 6

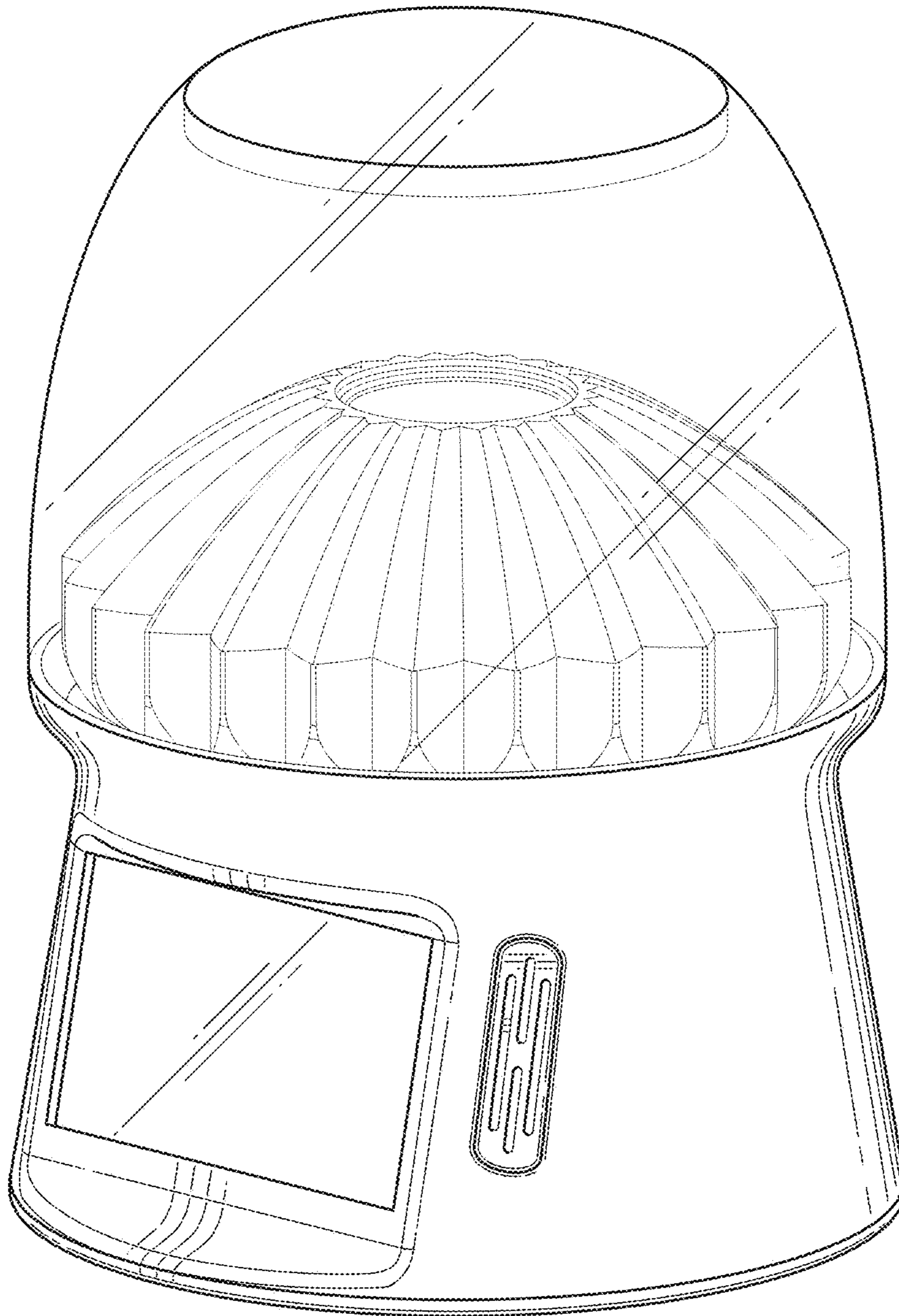

FIG. 7