



US00D931160S

(12) **United States Design Patent** (10) **Patent No.:** **US D931,160 S**
Forrest et al. (45) **Date of Patent:** **** Sep. 21, 2021**

(54) **FRONT BUMPER FOR A VEHICLE**

(71) Applicant: **Bayerische Motoren Werke Aktiengesellschaft, Munich (DE)**

(72) Inventors: **Robert Peter Forrest, Munich (DE); Karl-Johann Elmitt, Eching (DE)**

(73) Assignee: **Bayerische Motoren Werke Aktiengesellschaft, Munich (DE)**

(**) Term: **15 Years**

(21) Appl. No.: **29/734,741**

(22) Filed: **May 15, 2020**

(30) **Foreign Application Priority Data**

Nov. 18, 2019 (DE) 402019101251.6

(51) **LOC (13) Cl.** **12-16**

(52) **U.S. Cl.**
USPC **D12/169**

(58) **Field of Classification Search**
USPC D12/169, 163, 196, 86, 90-92;
296/180.1, 180.2; 293/102, 115, 117, 120
CPC B60R 19/52; B60R 2019/25; B62D 25/084
See application file for complete search history.

(56) **References Cited**

U.S. PATENT DOCUMENTS

- D514,990 S 2/2006 Nagashima
- D536,285 S 2/2007 Sycha
- D716,199 S * 10/2014 Beermann D12/169
- D735,096 S * 7/2015 Nissl D12/169
- D748,543 S * 2/2016 Nissl D12/169
- D772,119 S 11/2016 De Bono
- D772,122 S * 11/2016 Zurian D12/169
- D787,377 S * 5/2017 Al Attar D12/92
- D787,990 S * 5/2017 Kozub D12/169
- D803,100 S * 11/2017 Forschner D12/92

- D803,112 S * 11/2017 Tomita D12/169
- D823,746 S * 7/2018 Lim D12/169
- D823,747 S * 7/2018 Tsarukyan D12/169
- D825,412 S * 8/2018 Luk D12/169
- D825,414 S * 8/2018 De Bono D12/169
- D855,510 S * 8/2019 Nissl D12/169
- D864,056 S * 10/2019 Morikawa D12/169
- D866,415 S * 11/2019 Kezha D12/169
- D867,233 S * 11/2019 Peplowski D12/169

(Continued)

FOREIGN PATENT DOCUMENTS

- WO WO DM/065775 11/2004
- WO WO DM/066886 9/2005

(Continued)

Primary Examiner — Melody N Brown

(74) *Attorney, Agent, or Firm* — Crowell & Moring LLP

(57) **CLAIM**

The ornamental design for a front bumper for a vehicle, as shown and described.

DESCRIPTION

This application contains subject matter related to the following co-pending U.S. design patent applications: Application Ser. No. 29/734,746, filed herewith and entitled “Front Bumper for a Vehicle”; and Application Ser. No. 29/734,740, filed herewith and entitled “Front Bumper for a Vehicle”.

FIG. 1 is a front view of a front bumper for a vehicle according to the design;

FIG. 2 is a right, front perspective view thereof;

FIG. 3 is a left, bottom perspective view thereof;

FIG. 4 is a right side view thereof;

FIG. 5 is a left side view thereof;

FIG. 6 is a top view thereof;

FIG. 7 is a bottom view thereof; and,

FIG. 8 is a rear view thereof.

1 Claim, 8 Drawing Sheets

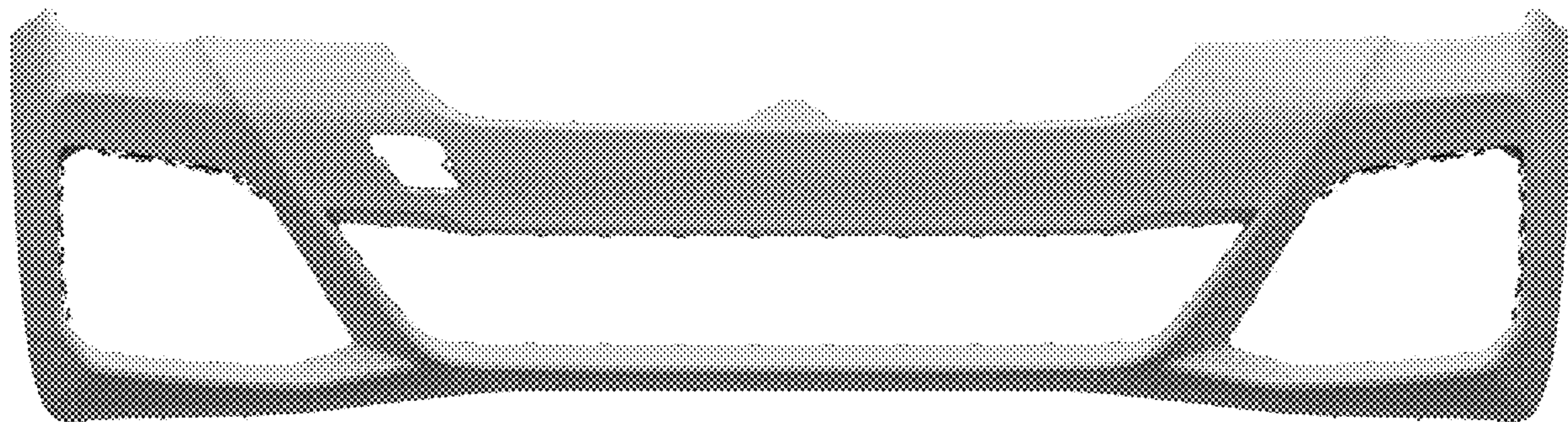

(56)

References Cited

U.S. PATENT DOCUMENTS

D875,624 S * 2/2020 Tanghe D12/169
D890,650 S * 7/2020 Kang D12/169
D890,652 S 7/2020 Al Attar
D891,323 S * 7/2020 Peplowski D12/169
D897,240 S * 9/2020 Al Attar D12/91

FOREIGN PATENT DOCUMENTS

WO WO DM/084038 1/2015
WO WO DM/203407 12/2019

* cited by examiner

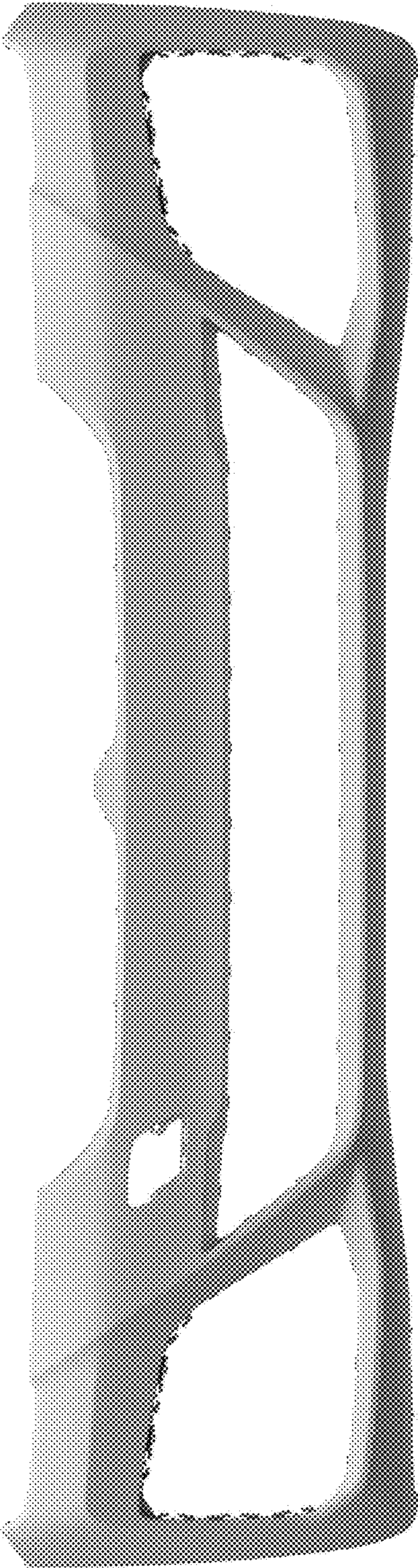

Fig. 1

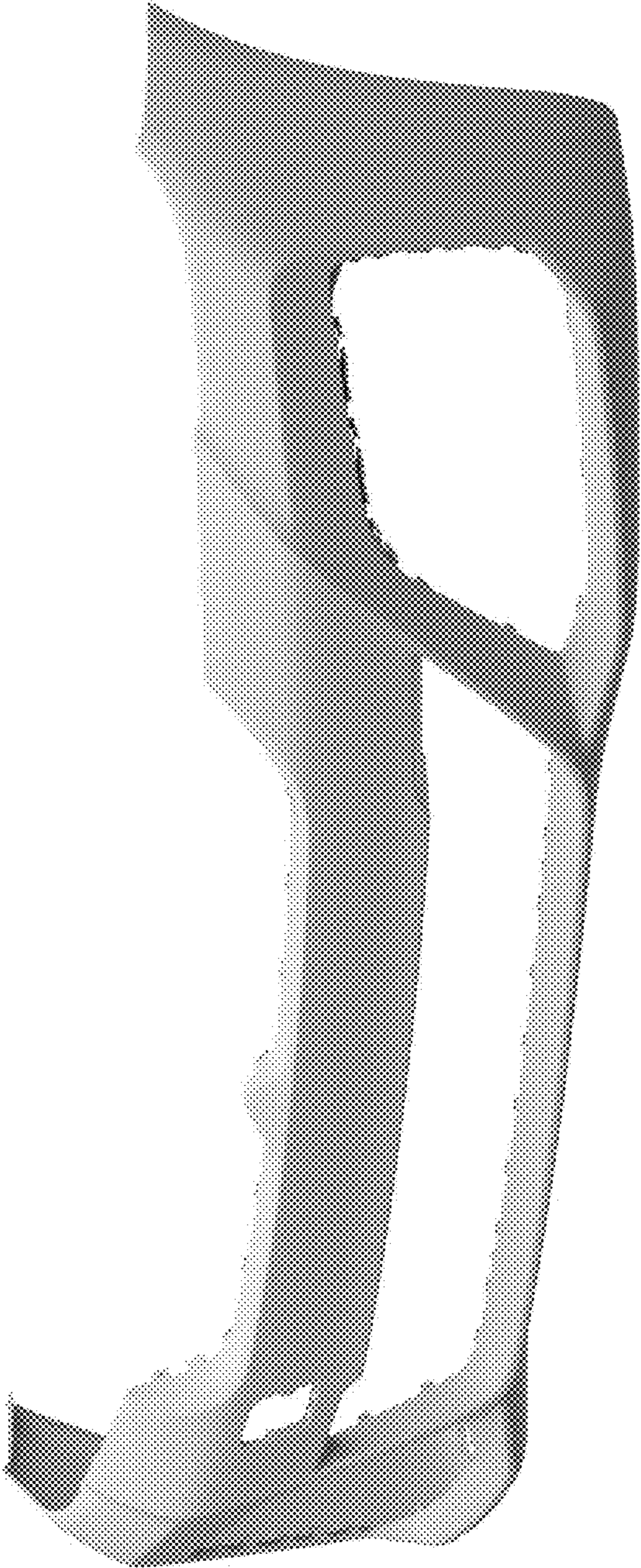

Fig. 2

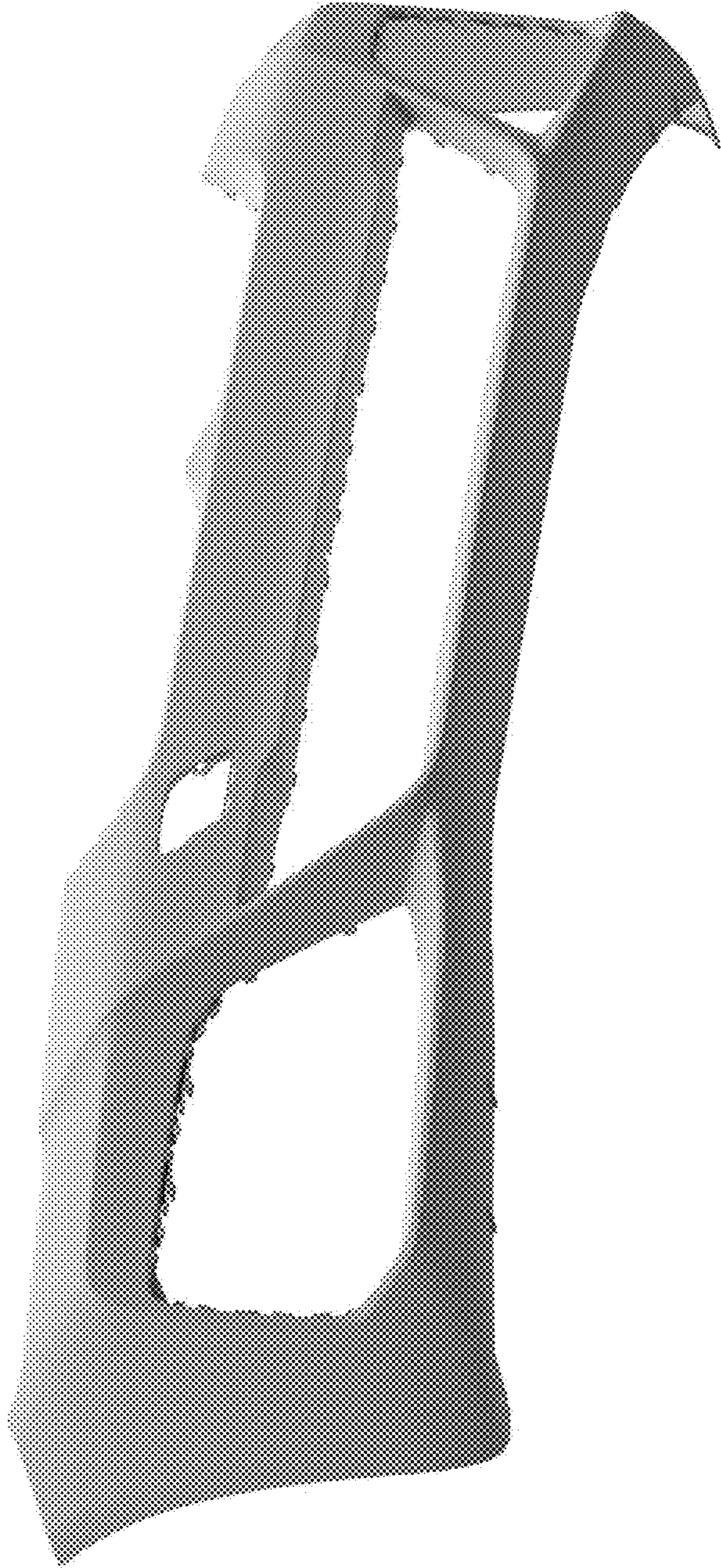

Fig. 3

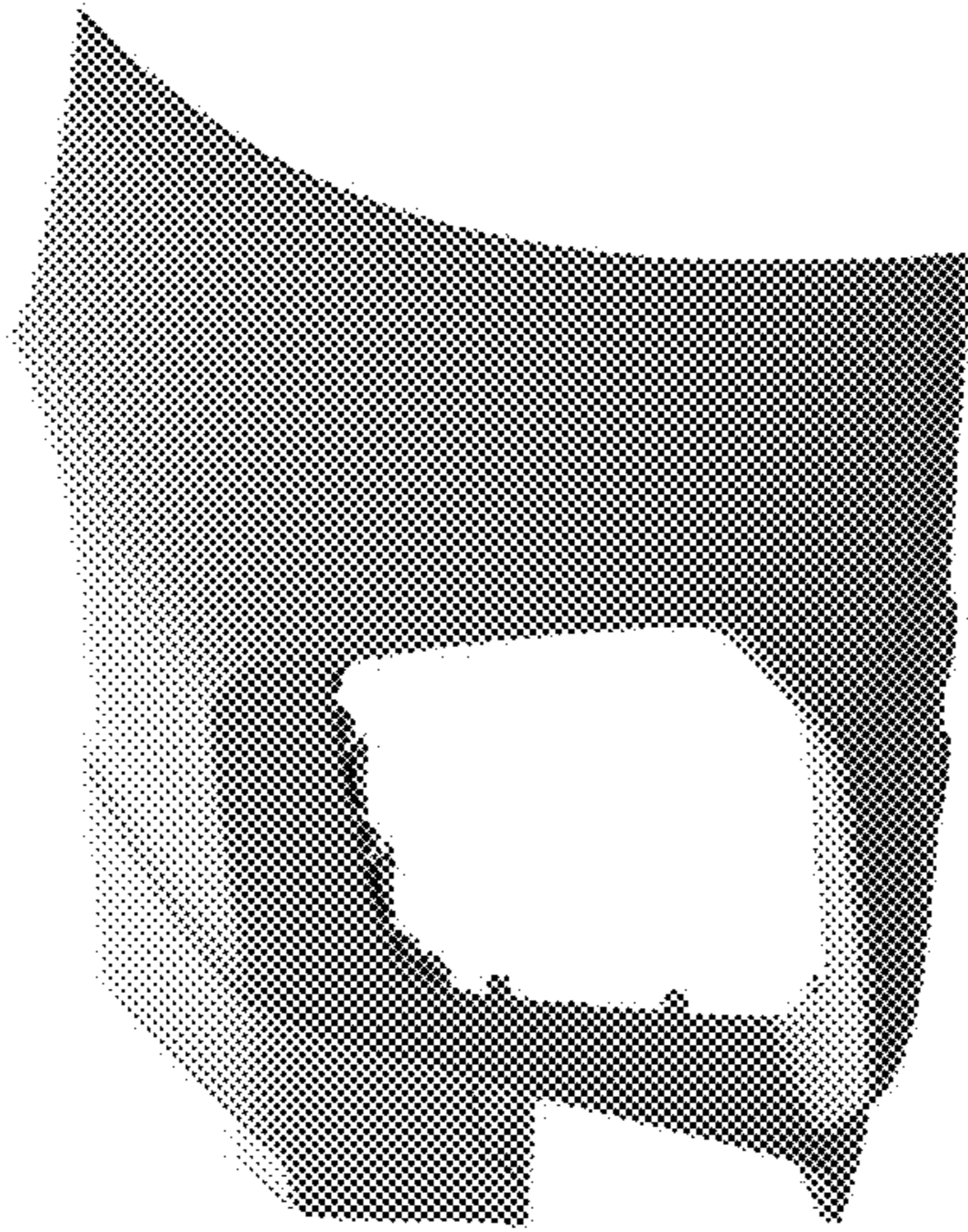

Fig. 4

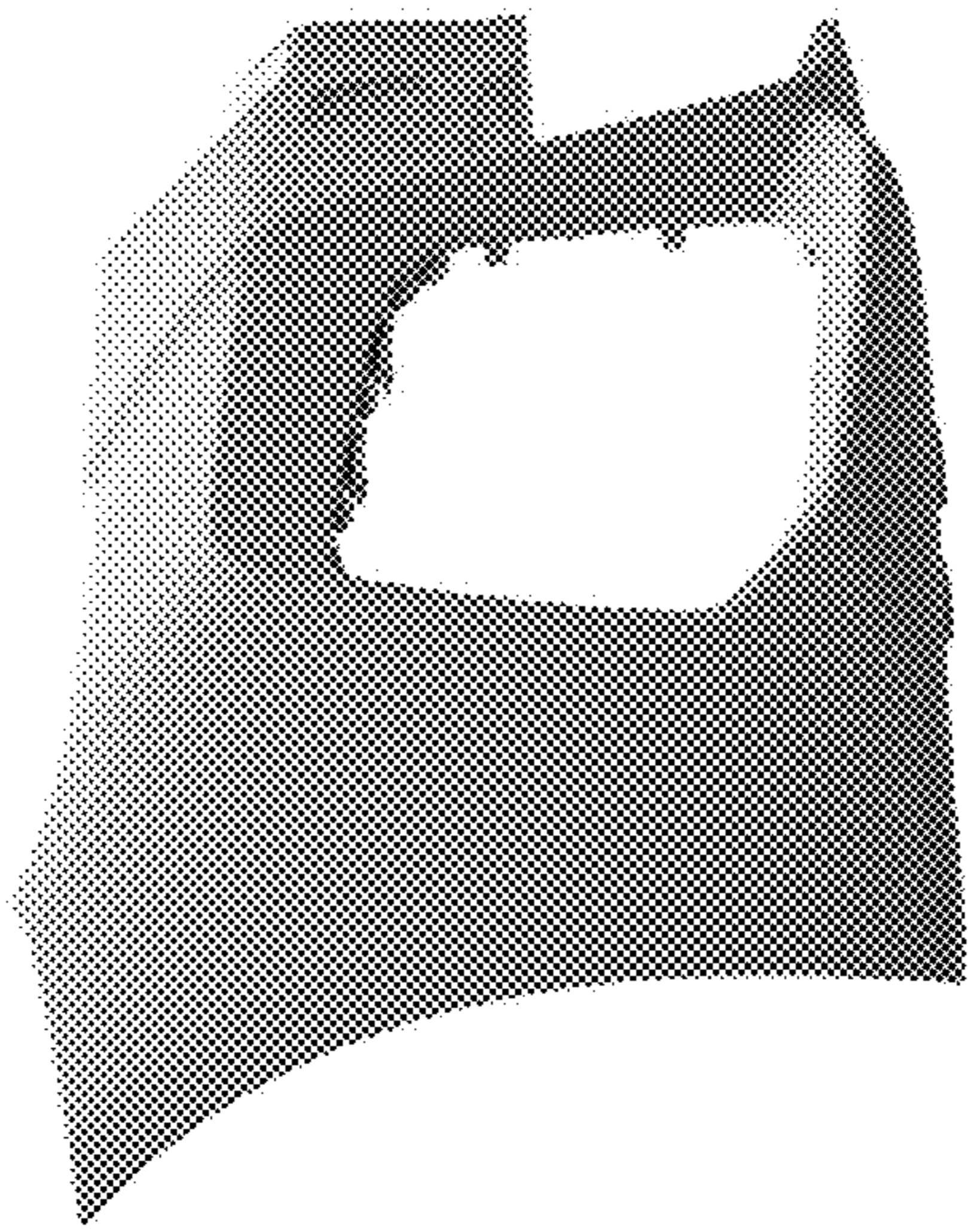

Fig. 5

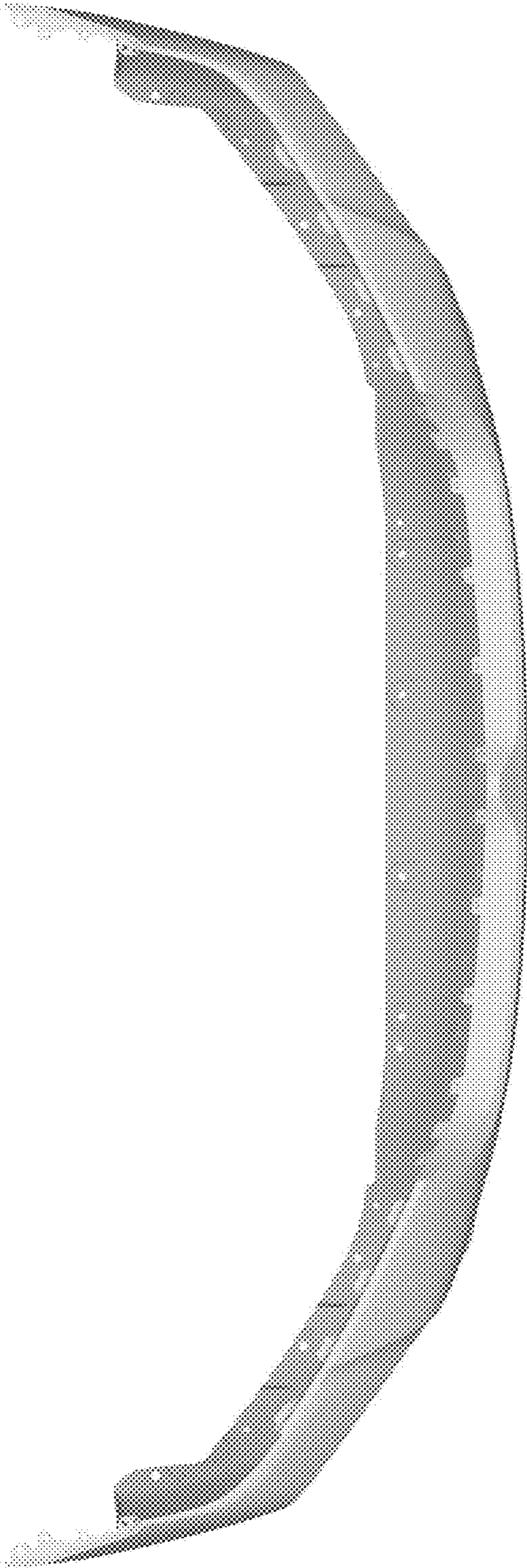

Fig. 6

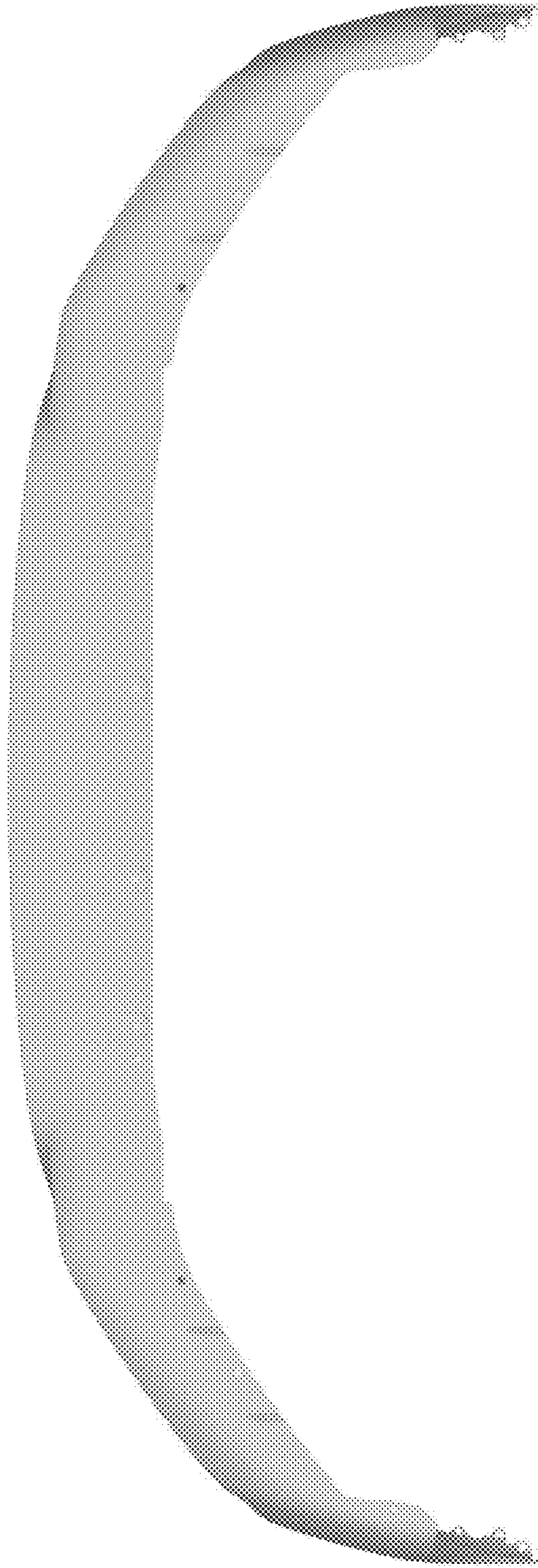

Fig. 7

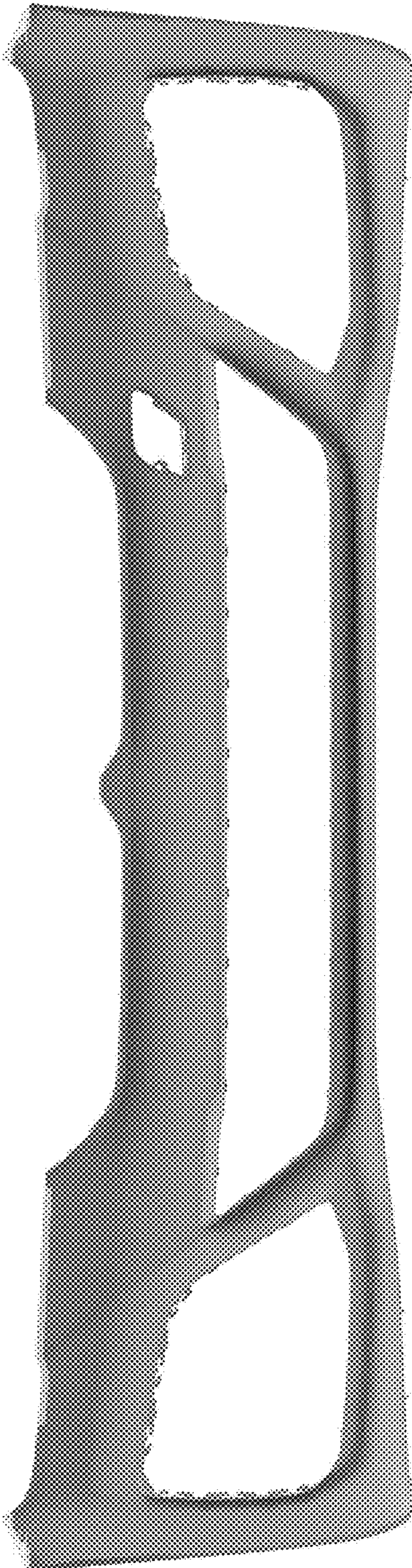

Fig. 8