



US00D931089S

(12) **United States Design Patent** (10) **Patent No.:** **US D931,089 S**
Guo (45) **Date of Patent:** **** Sep. 21, 2021**

(54) **ROOFTOP CARGO HOOKS**
(71) Applicant: **Zeshan Guo**, Gaoyou (CN)
(72) Inventor: **Zeshan Guo**, Gaoyou (CN)
(73) Assignee: **GLOBEGOU WZ CO., LTD**, Zhejiang (CN)
(**) Term: **15 Years**
(21) Appl. No.: **29/749,881**
(22) Filed: **Sep. 9, 2020**
(51) **LOC (13) Cl.** **08-05**
(52) **U.S. Cl.**
USPC **D8/367**
(58) **Field of Classification Search**
USPC D8/367, 356, 354, 349; D12/420, 223;
24/16 PB; 361/826
CPC B60R 7/043; B60R 7/08; A47C 7/52
See application file for complete search history.

(56) **References Cited**

U.S. PATENT DOCUMENTS

D42,169 S * 2/1912 Ford D8/371
3,919,740 A * 11/1975 Scherb A22C 15/006
452/187
5,094,417 A * 3/1992 Creed A47G 29/083
248/215
5,325,568 A * 7/1994 Bruhm B60P 7/0823
24/265 CD
5,647,619 A * 7/1997 DeLisio E05C 17/36
292/262
D398,220 S * 9/1998 Woods D8/367
D415,067 S * 10/1999 Tung D11/200
D426,764 S * 6/2000 Szabo D8/367
D480,946 S * 10/2003 Estep, Jr. D8/367
D549,559 S * 8/2007 Polano D8/367
7,322,655 B1 * 1/2008 Williams A47C 7/52
297/423.15

D573,875 S * 7/2008 Anderson D8/367
D623,505 S * 9/2010 Tu D8/367
D638,330 S * 5/2011 Fahrendorff D11/200
D694,096 S * 11/2013 DeFrancisci D8/367
D707,233 S * 6/2014 Sirichai D14/447
D707,536 S * 6/2014 Van Riper D8/367
8,910,347 B1 * 12/2014 Wilcox B65D 63/109
24/16 R
9,102,276 B1 * 8/2015 Virgin B60R 7/043
D767,977 S * 10/2016 Man D8/367
D790,345 S * 6/2017 Nolan D9/455
10,214,149 B2 * 2/2019 Nolan B60R 7/043
10,343,612 B1 * 7/2019 Allred B60R 7/14
10,391,920 B2 * 8/2019 Squires B60P 3/079
10,471,899 B2 * 11/2019 Ackeret B60R 7/08
D878,909 S * 3/2020 Krake D8/367
D885,873 S * 6/2020 Deng D8/367
D893,985 S 8/2020 Dankert
D899,234 S * 10/2020 Chen D8/367
D915,181 S * 4/2021 Chen D8/367
2011/0101055 A1 * 5/2011 O'Neill B60R 7/043
224/275
2011/0203441 A1 * 8/2011 Naylor G10G 5/005
84/327

* cited by examiner

Primary Examiner — Cynthia R Underwood
(74) *Attorney, Agent, or Firm* — Justin Lampel

(57) **CLAIM**

The ornamental design for a rooftop cargo hooks, as shown and described.

DESCRIPTION

FIG. 1 is a perspective view of the claimed design;
FIG. 2 is a right side view thereof;
FIG. 3 is a rear elevational view thereof;
FIG. 4 is a bottom plan view thereof;
FIG. 5 is a front side view thereof;
FIG. 6 is a top elevational view thereof; and,
FIG. 7 is a left side view thereof.

1 Claim, 7 Drawing Sheets

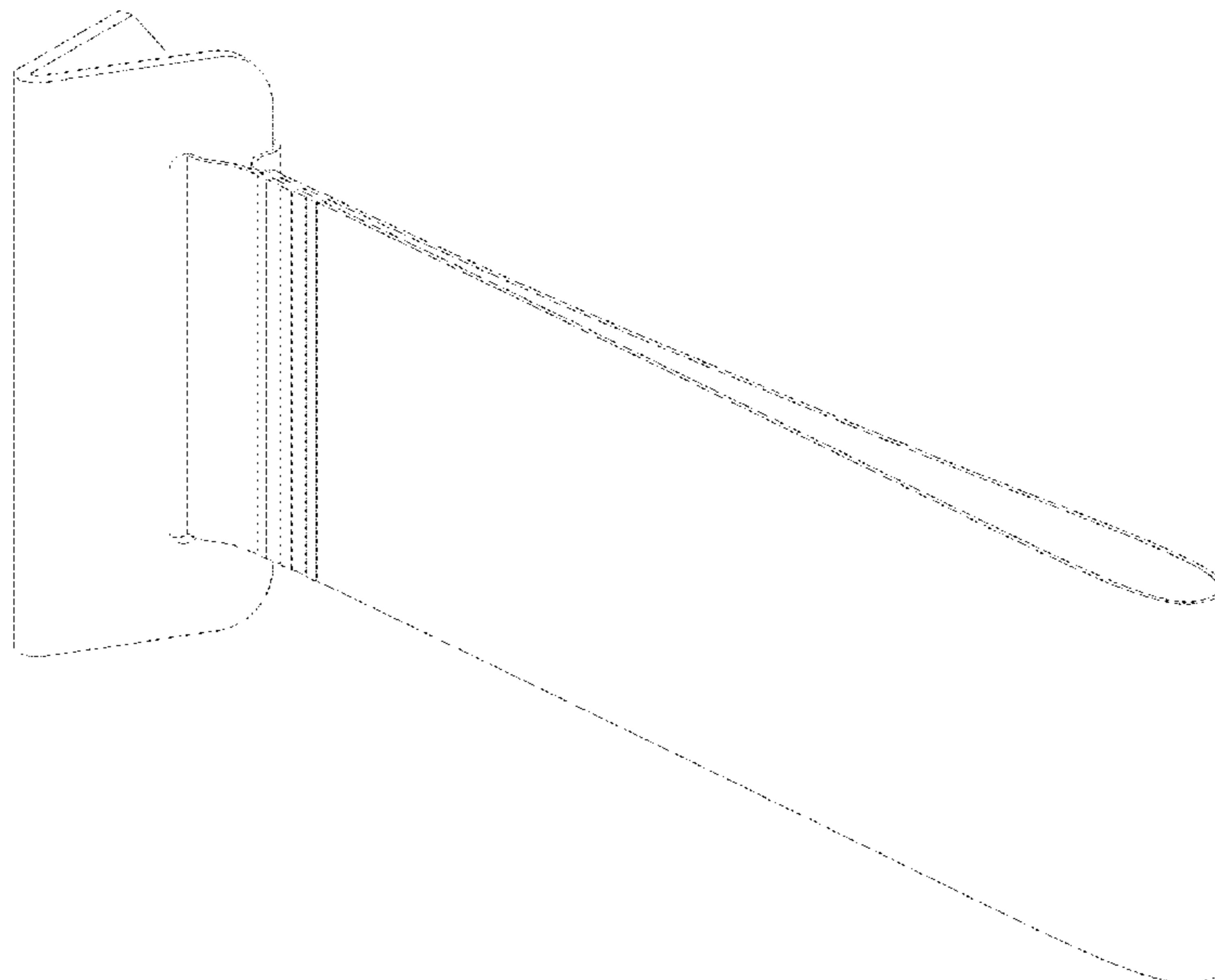

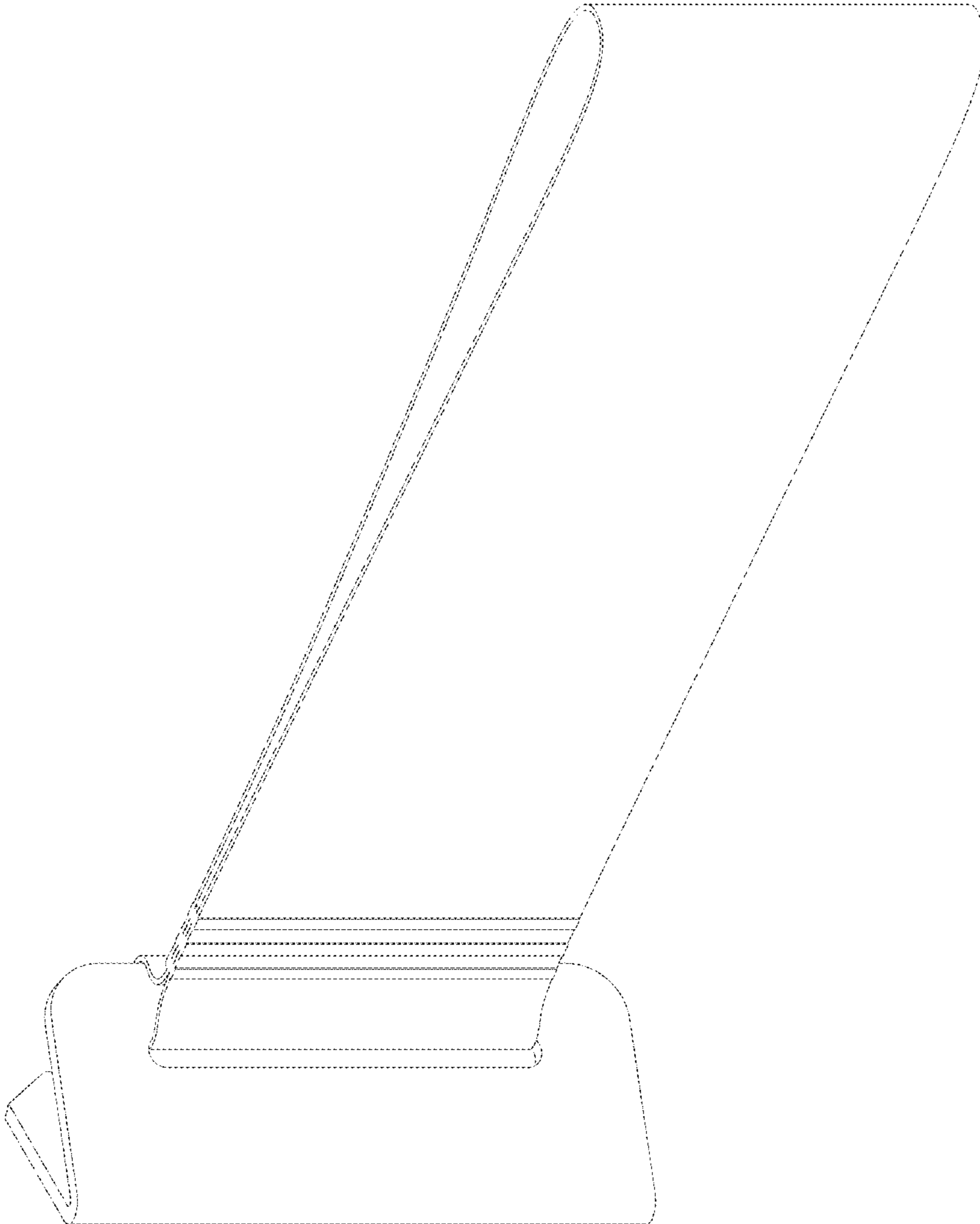

FIG. 1

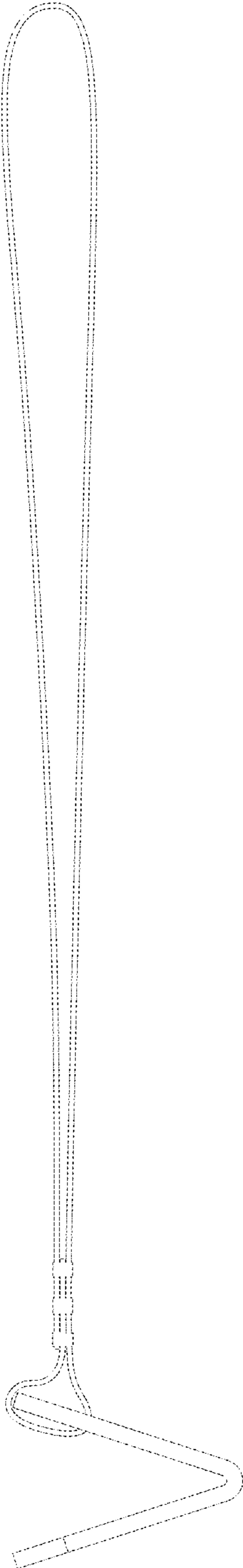

FIG. 2

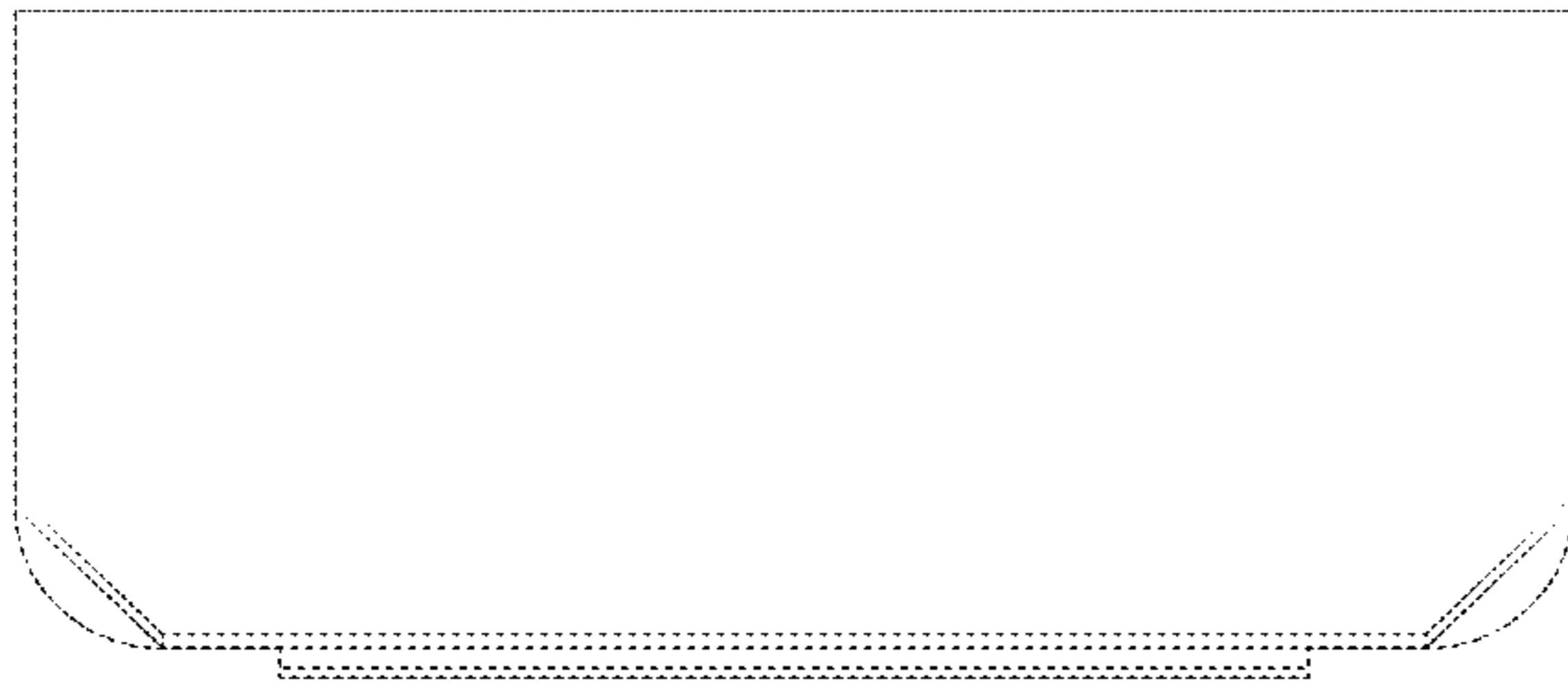

FIG. 3

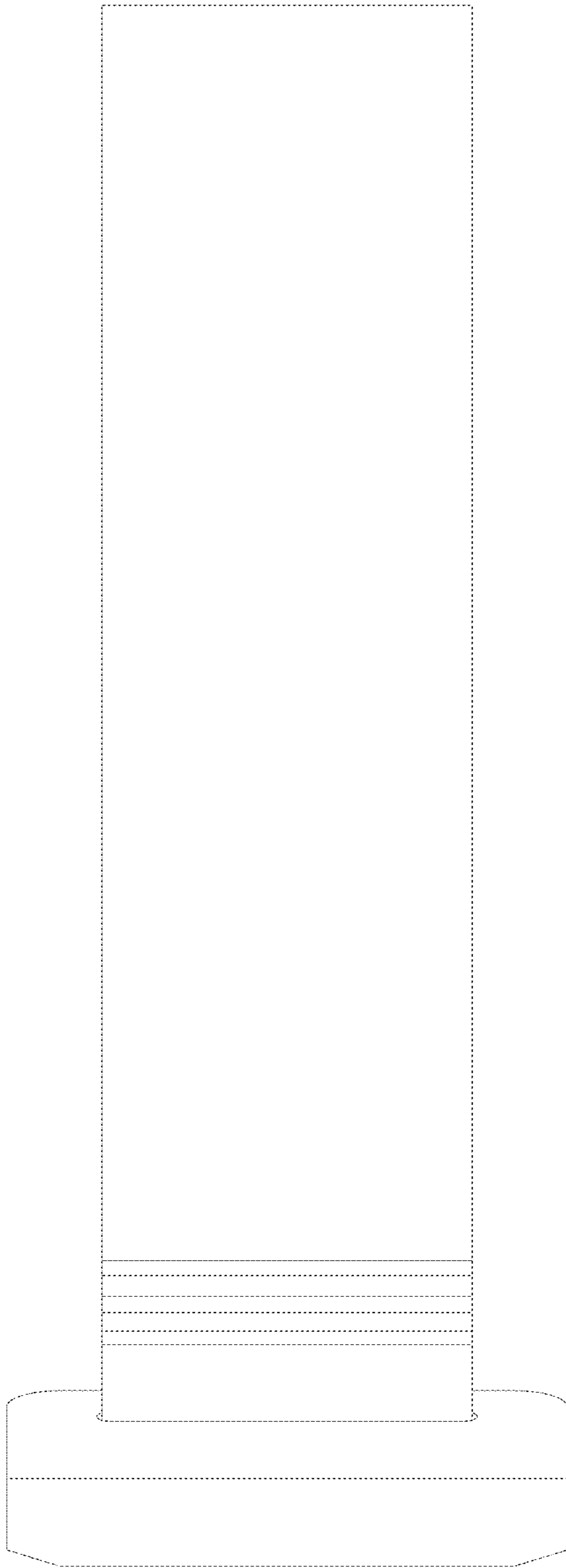

FIG. 4



FIG. 5

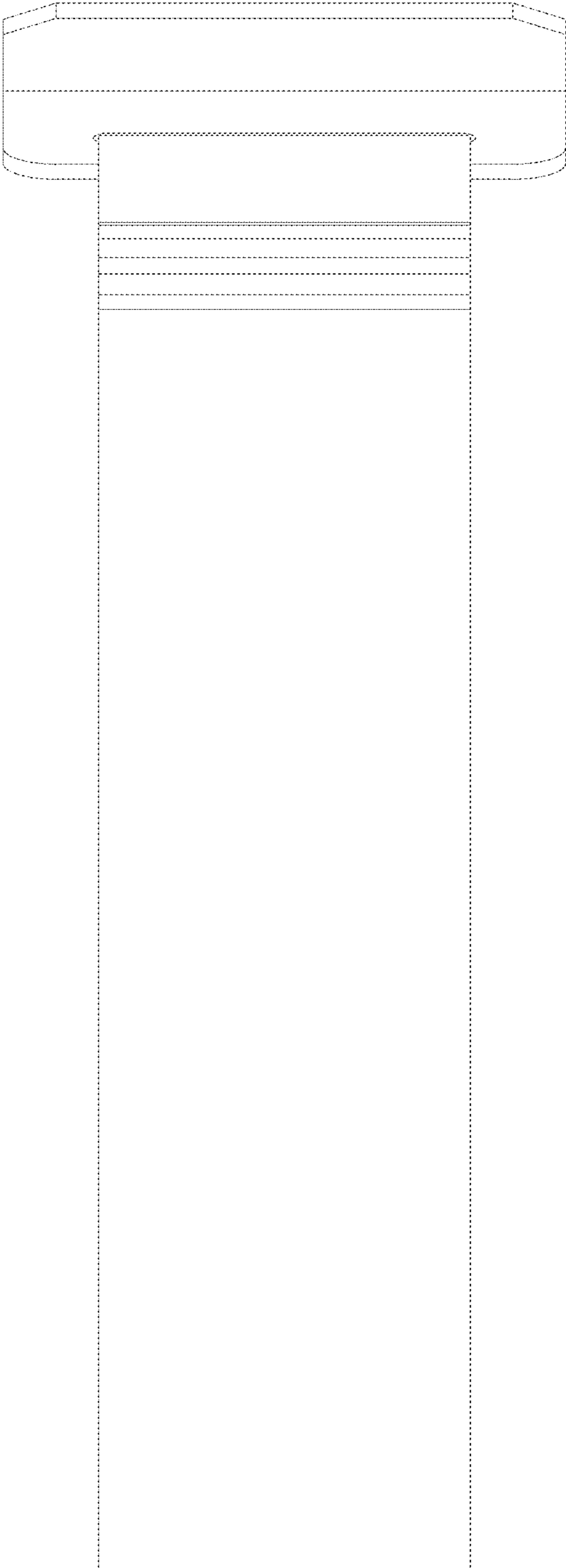

FIG. 6

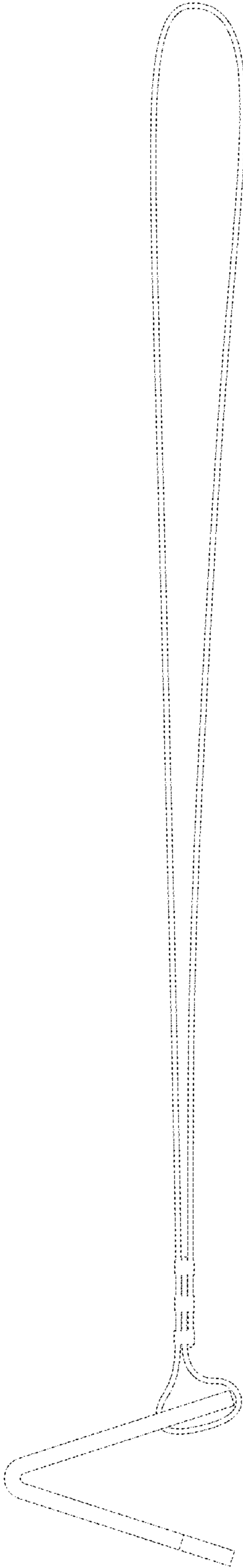

FIG. 7