



US00D931016S

(12) **United States Design Patent** (10) **Patent No.:** **US D931,016 S**
Davis et al. (45) **Date of Patent:** **** Sep. 21, 2021**

(54) **CONSOLE**
(71) Applicant: **WALKER EDISON FURNITURE COMPANY LLC**, Salt Lake City, UT (US)
(72) Inventors: **Matthew Davis**, Millcreek, UT (US); **Brad Bonham**, Draper, UT (US); **Richard Packer**, Kaysville, UT (US); **Tiffany Duhadway**, Salt Lake City, UT (US)
(73) Assignee: **Walker Edison Furniture Company LLC**, West Jordan, UT (US)

D66,028 S 11/1924 Lyons et al.
D66,889 S 3/1925 Schleicher
1,538,393 A 5/1925 Martin
D68,065 S 8/1925 Schleicher
D68,659 S 11/1925 Smith
D78,127 S 3/1929 Schleicher
D103,250 S 2/1937 Parrish
D120,370 S 5/1940 Bach

(Continued)

FOREIGN PATENT DOCUMENTS

CN 304163895 9/2017
CN 304770575 8/2018

(Continued)

(**) Term: **15 Years**

OTHER PUBLICATIONS

(21) Appl. No.: **29/720,732**

U.S. Appl. No. 29/611,963, filed Jul. 27, 2017, Davis.

(Continued)

(22) Filed: **Jan. 15, 2020**

(51) **LOC (13) Cl.** **06-04**

Primary Examiner — Cathron C Brooks

(52) **U.S. Cl.** **D6/657**

(74) *Attorney, Agent, or Firm* — Workman Nydegger

(58) **Field of Classification Search**

(57)

CLAIM

USPC D6/657, 659, 660, 661, 662, 662.1, 671, D6/671.1

The ornamental design for a console, as shown and described.

CPC . A47B 67/00; A47B 67/04; A47B 2220/0072; A47B 2220/01; A47B 85/00

DESCRIPTION

See application file for complete search history.

FIG. 1 is a front perspective view of a console showing the new design;

FIG. 2 is a front elevation view thereof;

FIG. 3 is a back elevation view thereof;

FIG. 4 is a top plan view thereof;

FIG. 5 is a bottom plan view thereof;

FIG. 6 is a right elevation view thereof; and,

FIG. 7 is a left elevation view thereof.

The broken lines in the drawings are for the purpose of illustrating portions of the article that form no part of the claimed design.

(56) **References Cited**

U.S. PATENT DOCUMENTS

245,925 A 8/1881 Kinsley
309,799 A 12/1884 Poulson
887,168 A 5/1908 Will
1,097,697 A 5/1914 Weston
D47,441 S 6/1915 Ullin
D47,600 S 7/1915 Koch
D61,344 S 8/1922 Mayer
1,475,088 A 11/1923 Specht et al.
D64,390 S 4/1924 Arons
D64,922 S 6/1924 Nail

1 Claim, 4 Drawing Sheets

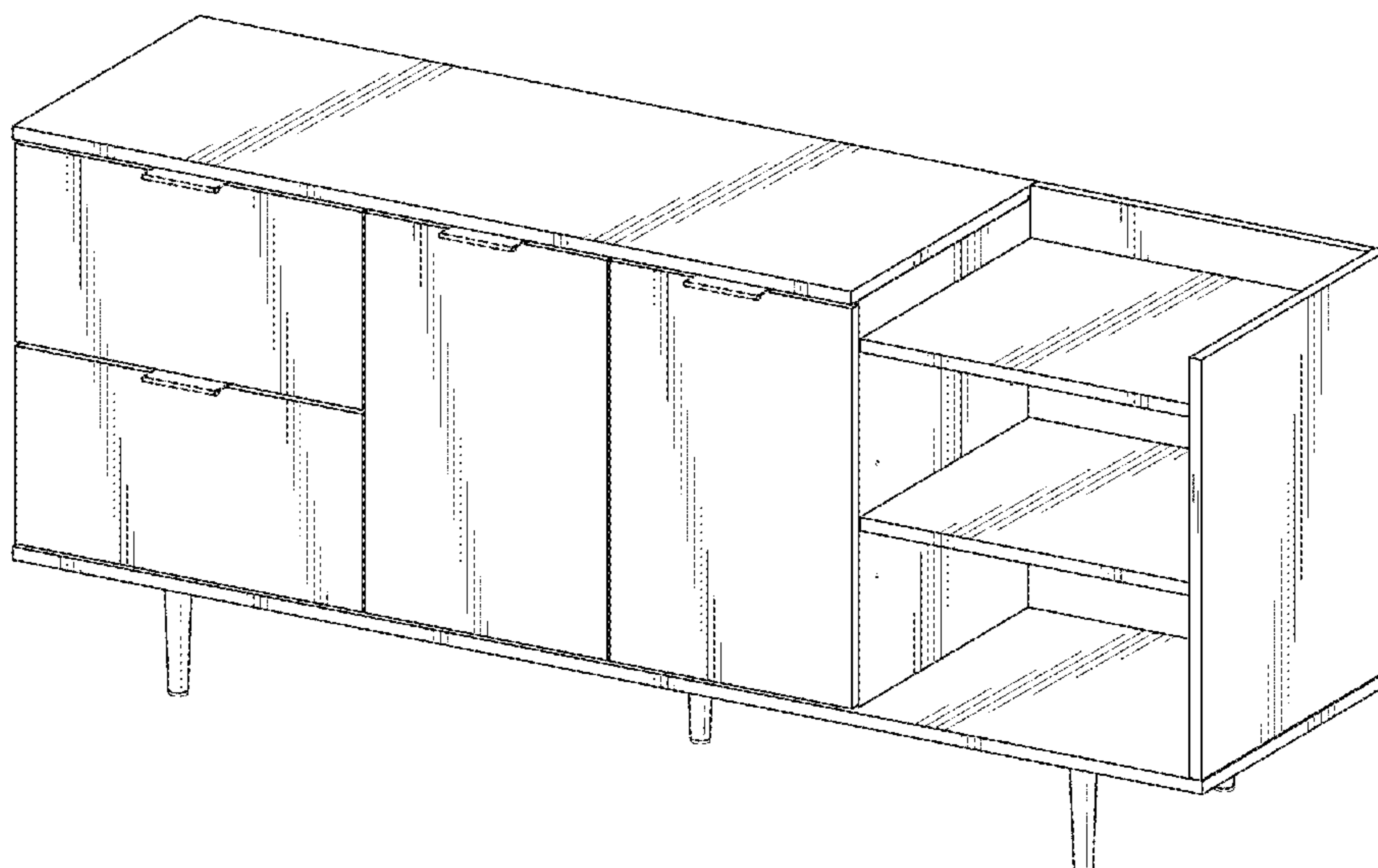

(56)

References Cited

FOREIGN PATENT DOCUMENTS

U.S. PATENT DOCUMENTS

D848,766 S 5/2019 Chen
 D848,767 S 5/2019 Smrstick
 D848,768 S 5/2019 Johnson
 D848,770 S 5/2019 Davis
 D849,457 S 5/2019 Kundig
 D850,815 S 6/2019 Nicoll
 D851,426 S 6/2019 Saotome
 D852,429 S 6/2019 Rathman
 D853,052 S 7/2019 Rathman
 D858,148 S 9/2019 Crutcher
 D859,038 S 9/2019 Davis
 D860,687 S 9/2019 Parikh
 D861,388 S * 10/2019 Bray D6/671
 D862,940 S * 10/2019 Bray D6/663
 D866,225 S 11/2019 Gelman
 D867,032 S * 11/2019 Bellini D6/671
 D869,201 S 12/2019 Davis
 D869,202 S 12/2019 Davis
 D870,492 S 12/2019 Young
 D870,493 S 12/2019 Young
 D874,192 S 2/2020 Velez
 D878,116 S 3/2020 Davis
 D878,816 S 3/2020 Davis
 D878,817 S 3/2020 Davis
 D878,823 S 3/2020 Davis
 D879,516 S 3/2020 Davis
 D882,989 S 5/2020 Davis
 D885,091 S 5/2020 Davis
 D886,499 S 6/2020 Davis
 D888,467 S 6/2020 Li
 D891,831 S 8/2020 Davis
 D894,641 S 9/2020 Davis
 D900,510 S 11/2020 Davis
 2004/0074858 A1 4/2004 Thuma
 2004/0079714 A1 4/2004 Andrew
 2004/0222721 A1 11/2004 Kelley
 2004/0237853 A1 12/2004 Sholz
 2005/0000241 A1 1/2005 Kucera
 2005/0103734 A1 5/2005 Saltzberg
 2007/0062983 A1 3/2007 Barnett
 2007/0138119 A1 6/2007 Schwerdlin
 2007/0236111 A1 10/2007 Gray
 2007/0236113 A1 10/2007 McCambridge
 2008/0116771 A1 5/2008 Green
 2008/0181587 A1 7/2008 Patil
 2008/0203042 A1 8/2008 Felsenthal
 2008/0216817 A1 9/2008 Yungbluth
 2009/0025414 A1 1/2009 Koga
 2009/0151375 A1 6/2009 Tarr
 2009/0170421 A1 7/2009 Adrian
 2009/0220221 A1 9/2009 Zhou
 2010/0307179 A1 12/2010 Fava
 2011/0000477 A1 1/2011 Kwon
 2011/0017691 A1 1/2011 Wu
 2011/0079688 A1 4/2011 Grove
 2011/0080261 A1 4/2011 Asofsky
 2011/0120166 A1 5/2011 Nadel
 2011/0220090 A1 9/2011 Atemboski
 2014/0116418 A1 5/2014 Thomas
 2014/0239136 A1 8/2014 Ortega
 2014/0252939 A1 9/2014 Tunzi
 2014/0265754 A1 9/2014 Patterson
 2014/0265807 A1 9/2014 Kendall
 2014/0318529 A1 10/2014 Nielsen
 2015/0182021 A1 7/2015 Chang
 2015/0323190 A1 11/2015 Stein
 2016/0018112 A1 1/2016 Phillips
 2016/0100698 A1 4/2016 Clark
 2016/0157605 A1 6/2016 Grad
 2016/0209102 A1 7/2016 Vulava
 2016/0223213 A1 8/2016 Grehova
 2016/0256032 A1 9/2016 Bhajak
 2017/0089587 A1 3/2017 Nemes
 2017/0211814 A1 7/2017 Bourne
 2018/0064246 A1 3/2018 Kassanoff

CN 305138614 5/2019
 EM 003068485-0003 4/2016
 EM 003254200-0003 6/2016
 EM 005646783-0006 9/2018
 GB 1162368 8/1969
 GB 4001474 5/2007
 GB 4032905 11/2013
 GB 4034171 7/2014
 GB 6041896 8/2018
 WO WOD076242-061 5/2011

OTHER PUBLICATIONS

U.S. Appl. No. 29/634,946, filed Jan. 25, 2018, Davis.
 U.S. Appl. No. 29/654,950, filed Jun. 28, 2018, Davis.
 U.S. Appl. No. 29/720,093, filed Jan. 9, 2020, Davis.
 U.S. Appl. No. 29/656,499, filed Jul. 12, 2018, Davis.
 U.S. Appl. No. 29/656,479, filed Jul. 12, 2018, Davis.
 U.S. Appl. No. 29/656,485, filed Jul. 12, 2018, Davis.
 U.S. Appl. No. 29/656,486, filed Jul. 12, 2018, Davis.
 U.S. Appl. No. 29/656,497, filed Jul. 12, 2018, Davis.
 U.S. Appl. No. 29/654,930, filed Jun. 28, 2018, Davis.
 U.S. Appl. No. 29/656,936, filed Jun. 28, 2018, Davis.
 U.S. Appl. No. 29/654,952, filed Jun. 28, 2018, Davis.
 U.S. Appl. No. 29/656,492, filed Jul. 12, 2018, Davis.
 U.S. Appl. No. 29/656,489, filed Jul. 12, 2018, Davis.
 U.S. Appl. No. 29/634,889, filed Jan. 25, 2018, Davis.
 U.S. Appl. No. 29/677,722, filed Jan. 23, 2019, Davis.
 U.S. Appl. No. 29/677,723, filed Jan. 23, 2019, Davis.
 U.S. Appl. No. 29/677,724, filed Jan. 23, 2019, Davis.
 U.S. Appl. No. 29/677,738, filed Jan. 23, 2019, Davis.
 U.S. Appl. No. 29/677,755, filed Jan. 23, 2019, Davis.
 U.S. Appl. No. 29/677,761, filed Jan. 23, 2019, Davis.
 U.S. Appl. No. 29/698,919, filed Jul. 22, 2019, Davis.
 U.S. Appl. No. 29/698,924, filed Jul. 22, 2019, Davis.
 U.S. Appl. No. 29/698,928, filed Jul. 22, 2019, Davis.
 U.S. Appl. No. 29/698,940, filed Jul. 22, 2019, Davis.
 U.S. Appl. No. 29/699,063, filed Jul. 23, 2019, Davis.
 U.S. Appl. No. 29/699,066, filed Jul. 23, 2019, Davis.
 U.S. Appl. No. 29/714,849, filed Nov. 26, 2019, Davis.
 U.S. Appl. No. 29/699,071, filed Jul. 23, 2019, Davis.
 U.S. Appl. No. 29/699,073, filed Jul. 23, 2019, Davis.
 U.S. Appl. No. 29/699,078, filed Jul. 23, 2019, Davis.
 U.S. Appl. No. 29/698,942, filed Jul. 22, 2019, Davis.
 U.S. Appl. No. 29/698,947, filed Jul. 22, 2019, Davis.
 U.S. Appl. No. 29/720,729, filed Jan. 15, 2020, Davis.
 U.S. Appl. No. 29/721,435, filed Jan. 21, 2020, Davis.
 U.S. Appl. No. 29/720,734, filed Jan. 15, 2020, Davis.
 U.S. Appl. No. 29/720,923, filed Jan. 16, 2020, Davis.
 U.S. Appl. No. 29/720,927, filed Jan. 16, 2020, Davis.
 U.S. Appl. No. 29/720,942, filed Jan. 16, 2020, Davis.
 U.S. Appl. No. 29/720,948, filed Jan. 16, 2020, Davis.
 U.S. Appl. No. 29/721,166, filed Jan. 17, 2020, Davis.
 U.S. Appl. No. 29/743,237, filed Jul. 20, 2020, Packer.
 U.S. Appl. No. 29/743,240, filed Jul. 20, 2020, Packer.
 U.S. Appl. No. 29/743,244, filed Jul. 20, 2020, Packer.
 U.S. Appl. No. 29/743,246, filed Jul. 20, 2020, Packer.
 U.S. Appl. No. 29/743,247, filed Jul. 20, 2020, Packer.
 U.S. Appl. No. 29/743,250, filed Jul. 20, 2020, Packer.
 U.S. Appl. No. 29/743,416, filed Jul. 21, 2020, Packer.
 U.S. Appl. No. 29/743,418, filed Jul. 21, 2020, Packer.
 U.S. Appl. No. 29/743,423, filed Jul. 21, 2020, Packer.
 U.S. Appl. No. 29/743,584, filed Jul. 22, 2020, Packer.
 U.S. Appl. No. 29/728,971, filed Mar. 23, 2020, Davis.
 Electric fireplace, image post date May 26, 2014, site visited Aug. 8, 2016, (online), <<https://www.tineye.com/search/3c3d0cbfb7030b3079ebefa0774a5b4e94120332/?pluginver>.
 Media Console with Electric Fireplace, image postdate Dec. 6, 2015, site visited Aug. 8, 2016, (online), <<http://www.overstock.com/Home-Garden/Media-Console-with-Electric-Fireplace-in-Barnwood/10309735/product.html?recset=05953330-aaa1-4640->

(56)

References Cited

OTHER PUBLICATIONS

a796-f225c2f8176d&refccid=MRISGBB2MZGZXYKK4EFVI25H6Q&recalg=809,828,512&recidx=1 #reviews.
 Tv Stand With Fireplace, image post date Sep. 12, 2015, site visited Aug. 8, 2016, (online), <https://www.tineye.com/search/77be8934bf07249cbb245c8ea0f719199437b185/>.
 Walker Edison TV Stand with Fireplace Insert, image post date Jul. 31, 2015, site visited Aug. 8, 2016, (online), <https://www.amazon.com/Walker-Edison-Fireplace-Insert-Espresso/dp/BOOPNONTAK.
 Manchester Fireplace TV Console, image post date Dec. 17, 2015, site visited Aug. 8, 2016, (online), <http://www.walmart.com/ip/Manchester-Media-Fireplace-Stand-for-TVs-up-to-70/46360223.
 Monet Fireplace; Canadian Tire Company website: http://www.canadiantire.ca/en/pdp/monet-fireplace-0643572p.html; retrieved on Dec. 21, 2016.
 TV and Media Consoles, image post date Sep. 21, 2013, site visited Oct. 26, 2016, (online), <http://web.archive.org/web/20130921074219/http://www.electrictvfireplacesdirect.com/Gallery/tv-and-media-consoles.html>.*
 "Kendall Electric Media Fireplace—Espresso" Dec. 24, 2012, amazon.com, site visited Mar. 6, 2018 <https://www.amazon.com/Kendall-Electric-Media-Fireplace-Espresso/dp/B009LIT6XQ/ref=cm_cr_arpan_d_product_top?ie=UTF8> (Year: 2012).*
 "Whalen Media Fireplace Console for TVs up to 70" Gray" Nov. 24, 2015, walmart.com, site visited Mar. 6, 2018 <https://www.walmart.com/ip/Whalen-Media-Fireplace-Console-for-TVs-up-to-70-Gray/54189794> (Year: 2015).*
 "Boston Loft Furnishings . . ." Nov. 7, 2016, themine.com, site visited Mar. 2, 2018 <https://www.themine.com/tv-stands/boston-loft-furnishings-reamrock-infrared-electric-fireplace-media-stand-with-convertible-corner_g2733659.html> (Year: 2016).
 "Ameriwood Home Everett 70-inch . . ." Dec. 6, 2016, overstock.com, site visited Mar. 2, 2018 <https://www.overstock.com/Home-Garden/Ameriwood-Home-Everett-70-inch-Sonoma-Oak-TV-Stand-with-Glass-Doors/12710691/product.html> (Year: 2016).*
 Metal Coffee Table; https://www.overstock.com/Home-Garden/42-Metal-Coffee-Table-42-x-24-x-18h/15951452/product.html Retrieved on Nov. 13, 2018.
 Modern Two-Tone Writing Desk; https://www.overstock.com/Home-Garden/44-Modern-Two-Tone-Writing-Desk/19684325/product.html Retrieved on Nov. 13, 2018.
 Czapla TV Stand for TVs up to 65"; https://www.allmodern.com/furniture/pdp/mercury-row-czapla-tv-stand-for-tvs-up-to-65-a000303456.html ; Retrieved on May 7, 2019.
 Nelson Media Cabinet; https://www.franceandson.com/collections/storage-shelving-media-cabinets/products/nelson-media-cabinet36051 ; Retrieved on May 7, 2019.
 Hal TV Stand for TVs up to 60"; https://www.allmodern.com/furniture/pdp/hal-tv-stand-for-tvs-up-to-60-a000176456.html; Retrieved on May 7, 2019.
 Wigington TV Stand for TVs up to 60"; https://www.allmodern.com/furniture/pdp/wigington-tv-stand-for-tvs-up-to-60-golv3670.html?pid; Retrieved on May 7, 2019.
 Cliffmay Slat Media Stand Light Oak Brown—Project 62; https://www.target.com/p/cliffmay-slat-media-stand-light-oak-brown-project-62-153/-/A-53517373?ref=tgt_adv_XS000000&AFID=google_pla_df&fndsrt=tao&CPNG=PLA_Furniture%2BShopping_Priority%2BBrands&adgroup=SC_Project+62&LID=700000001170770pgs&network=g&device=c&location=F9029756&gclsrc=aw.ds&ds_rl=1246978&ds_rl=1247068&ds_rl=1246978&ref=tgt_adv_XS000000&AFID=google_pla_df&CPNG=PLA_Furniture+Shopping_Priority-i-Brands&adgroup=SC_Project%2062&LID=700000001170770pgs&network=g&device=c&location=902_9756&gclid=EAIalQobChMI7Nb9wo-H3wIVBy1pCh1fSg4IEAQYBSABEGK_yPD_BwE&gclsrc=aw.ds; Retrieved on May 7, 2019.
 Audrey Woven Media Console 65"; https://www.zinhome.com/audrey-woven-media-console-65/Retrieved on May 14, 2019.

Demilune Mesh Door Industrial Sideboard; https://belleescape.com/demilune-mesh-wire-door-industrial-chic-sideboard.html? SID=U ; Retrieved on May 14, 2019.
 Tuk Cabinet; https://blackroosterdecor.com/collections/storage-products/tuk-cabinet; Retrieved on May 14, 2019.
 Rustic Style 31 Inches Metal TV Stand With Wire Mesh Doors Cabinet, Black https://casagear.com/products/rustic-style-31-inches-metal-tv-stand-with-wire-mesh-doors-cabinet-black; May 14, 2019.
 Geo-Marquetry Buffet; https://www.anthropologie.com/shop/geo-marquetry-buffet?adpos=1_o27 &adtype=pla&cm_mmc=Google-US%20-%20Shopping%20-%20Furniture-_-Organizing%20 and%20Storage_-_-42699934&color=&countryCode=US&creative=191389729567&device=c&gclid=EA lalQobChMlvuTGgYOH3wIVEdNkCh3t8wRPEAkYGYABEGJG_PD_BwE&inventoryCountry= US&matchtype=&mrkgadid=3202938336&mrkgcl=694&network=g&product_id=42699934& quantity=1&size=ALL&type=STANDARD&utm_campaign=US%20-%20Shopping%20-%20Furniture&utm_content=42699934&utm_medium=paid_search&utm_source=Google&utm_term=Organizing%20and%20Storage; Retrieved on May 14, 2019.
 Suspend II Media Console; https://www.cb2.com/suspend-ii-media-console/s523915; Retrieved on May 14, 2019.
 Hooker Furniture Melange Mirrored Angle Console https://www.furniturecrate.com/hooker-melange-mirrored-angle-console.html?gdfrtk=gdFv21650_a_7c92_a_7c8357_a_7c654170&gclid=CjwKEAiA05unBR
 CymrGilanF9SwSJACqDFRm1WwgePUSp65sXRCI4RkIfScYn-yCjNuB-GTt3W-FxoCQL7w_wcB Retrieved on May 14, 2019.
 FurnitureMaxx Besteen Contemporary Wood Dark Gray Dining Room Server https://www.amazon.com/dp/B07GVS1VK2/ref=cm_sw_r_pi_dp_U_x_evuOBbFM3298G; Retrieved on May 14, 2019.
 Jaydyn Media TV Stand/Credenza https://www.macys.com/shop/product/jaydyn-media-tv-stand-credenza?ID=2883210&CategoryID=35319#fn=FURNITURE_CATEGORY=Buffet%20&%20Sideboards&SIZE=&sp=3&spc=131 &ruleId=129%7CBOOST%20ATTRIBUTE%7CBOOST%20SAVED%2QSET&searchPass=matchNone&slotId=2; Retrieved on May 14, 2019.
 Sideboard; https://www.allmodern.com/furniture/pdp/sideboard-sct11710.html; Retrieved on May 14, 2019.
 Belham Living Trenton Industrial End Table; https://www.hayneedle.com/product/belham-living-trenton-industrial-end-table-new.cfm?source=pla&kwid=OccasionalTables%20iprefer&tid=REDU113-1&adtype=pla&kw=&gclid=EA lalQobChMlvOu-6vel3wIVB8ZkChOZdAf-EAkYAyABEGLyMfD_BwE; Retrieved on May 15, 2019.
 Belham Living Hampton Chair Side Table—Black; https://www.hayneedle.com/product/belham-living-hampton-chair-side-table-black.cfm; Retrieved on May 15, 2019.
 International Concepts Hampton End Table https://www.hayneedle.com/product/internationalconceptshamptonendtable.cfm?source=pla&kwid=OccasionalTables%20level05&tid=WWI545-1&adtype=pla&kw=&gclid=EA lalQobChMlpsnoq_ml3wIVGNVCh348gtdEAKYliABEGLP7fD_BwE; Retrieved on May 15, 2019.
 Hampton Weathered Taupe Gray Coffee Table; https://www.homedepot.com/p/International-Concepts-Hampton-Weathered-Taupe-Gray-Coffee-Table-OT09-70C/302946359?MERCH=REC_-PIPHorizontal2_rr_-204737265_-302946359_-N; Retrieved on May 15, 2019.
 Convenience Concepts Oxford Rectangle Coffee Table https://www.hayneedle.com/product/convenience-concepts-oxford-rectangle-coffee-table.cfm?source=pla&kwid=OccasionalTables%20newkus&tid=CONV338-5&adtype=pla&kw=&gclid=EA lalQobChMlhuZv9_ml3wIVWx-tBh1rUA1tEAKYHYABEGJ2hPD_BwE; Retrieved on May 15, 2019.
 Belham Living Jamestown Rustic Coffee Table with Unique Driftwood Finish https://www.hayneedle.com/product/jamestown-rustic-coffee-table.cfm; Retrieved on May 15, 2019.
 Pinterest; www.pinterest.com/pin/336328451393621/; Retrieved on Jun. 12, 2019.
 Target Winham TV Stand—Threshold; www.target.com/p/windham-tv-stand-threshold-153/-/A-54301349; Retrieved on Jun. 12, 2019.

(56)

References Cited

OTHER PUBLICATIONS

Notice of Allowance for U.S. Appl. No. 29/677,755, dated Oct. 27, 2020.

Notice of Allowance for U.S. Appl. No. 29/720,923, dated Oct. 28, 2020.

Lorraine TV Stand for TVs up to 60" Retrieved online Nov. 3, 2020; from URL <https://www.wayfair.com/furniture/pdp/three-posts-lorraine-tv-stand-for-tvs-up-to-60-w001527559.html>.

Notice of Allowance for U.S. Appl. No. 29/698,942, dated Nov. 3, 2020.

Notice of Allowance for U.S. Appl. No. 29/699,073, dated Nov. 3, 2020.

Notice of Allowance for U.S. Appl. No. 29/721,435, dated Nov. 3, 2020.

"Alera Angled Doors Oak Wood Black Sideboard" <https://www.decorpad.com/bookmark.htm?bookmarkId=69182> (Retrieved Nov. 12, 2020).

"Linus Base Cabinet w/Double Angled Doors by HABA, 460499*" <https://gresscoltd.com/linus-base-cabinet-w-double-angled-doors-by-haba-460499.html> (Retrieved Nov. 12, 2020).

"Solid Acacia Wood Canyon Ridge Three Drawer Media TV Console ith Metal Base" <https://www.hootjudkins.com/solid-acacia-wood-canyon-ridge-three-drawer-media-tv-console-with-metal-base> (Retrieved Nov. 12, 2020).

Office Action for U.S. Appl. No. 29/756,291, dated Nov. 23, 2020. Barn Door Console, @sarahashleyallen on Instagram, Dec. 26, 2016, site visited Nov. 18, 2020, available online at <https://www.instagram.com/p/BOFH8jqgzjK/?taken-by=sarahashleyallen> (Year 2016).

DIY Barn Door Hardware, Ana White, Oct. 17, 2018, site visited Nov. 18, 2020, available online at <https://www.ana-white.com/woodworking-projects/diy-barn-door-hardware-washers> (Year: 2018).

Office Action for U.S. Appl. No. 29/698,919, dated Nov. 24, 2020. DIY Sliding Barn Door Console, Jaime Costiglio, Jan. 1, 2019, site visited Nov. 18, 2020, available online at <https://jaimecostiglio.com/diy-sliding-barn-door-console-free-plans/> (Year: 2019).

Notice of Allowance for U.S. Appl. No. 29/654,930, dated Dec. 10, 2020.

Notice of Allowance for U.S. Appl. No. 29/698,947, dated Dec. 10, 2020.

Notice of Allowance for U.S. Appl. No. 29/698,928, dated Dec. 11, 2020.

Notice of Allowance for U.S. Appl. No. 29/698,924, dated Dec. 18, 2020.

Notice of Allowance for U.S. Appl. No. 29/677,761, dated Dec. 22, 2020.

Notice of Allowance for U.S. Appl. No. 29/756,763, dated Dec. 22, 2020.

* cited by examiner

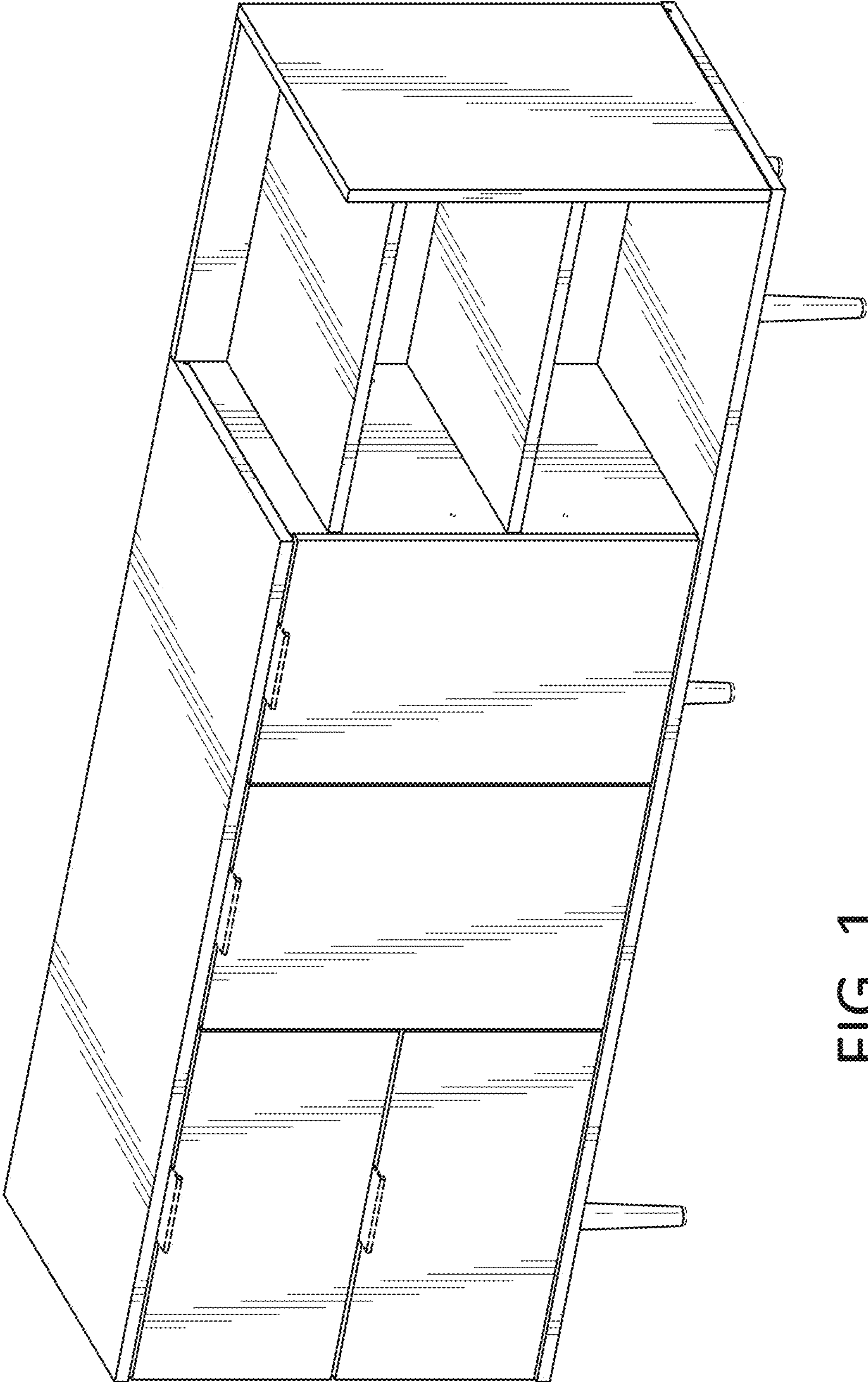

FIG. 1

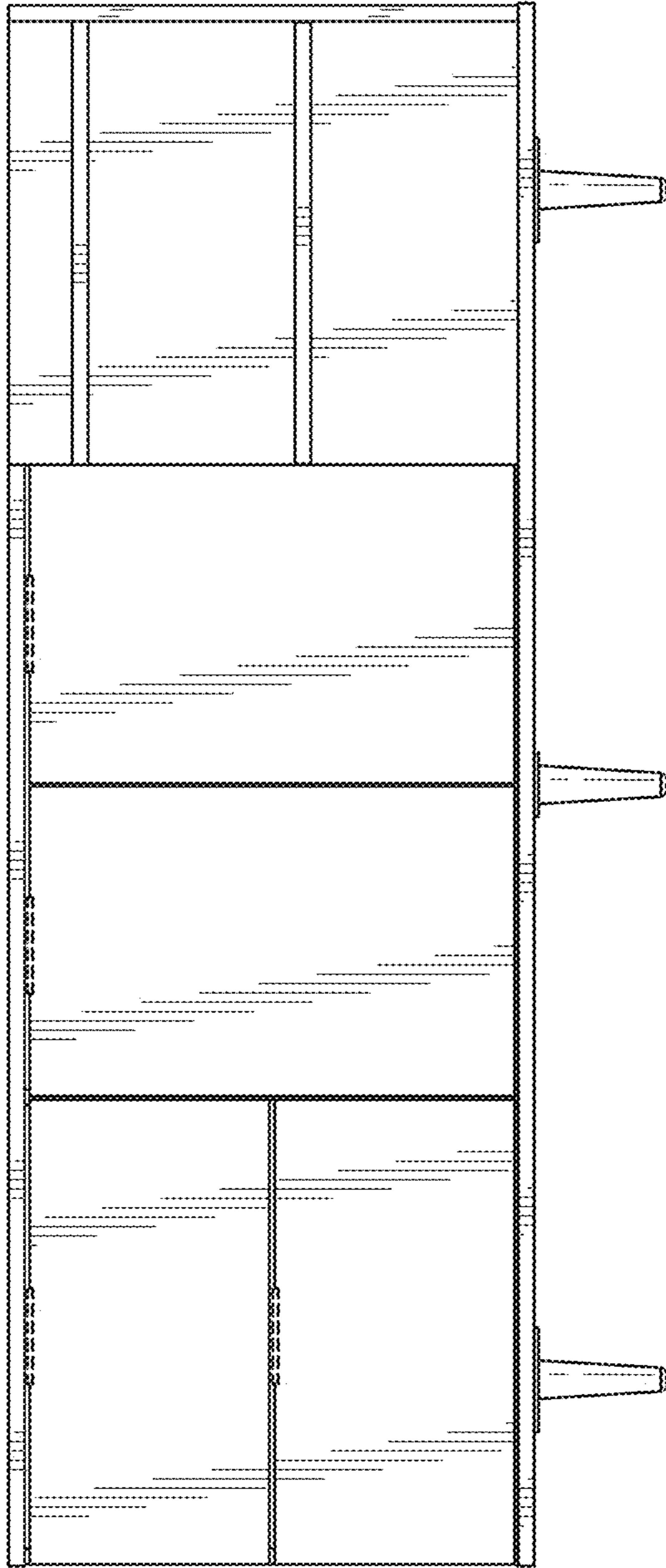

FIG. 2

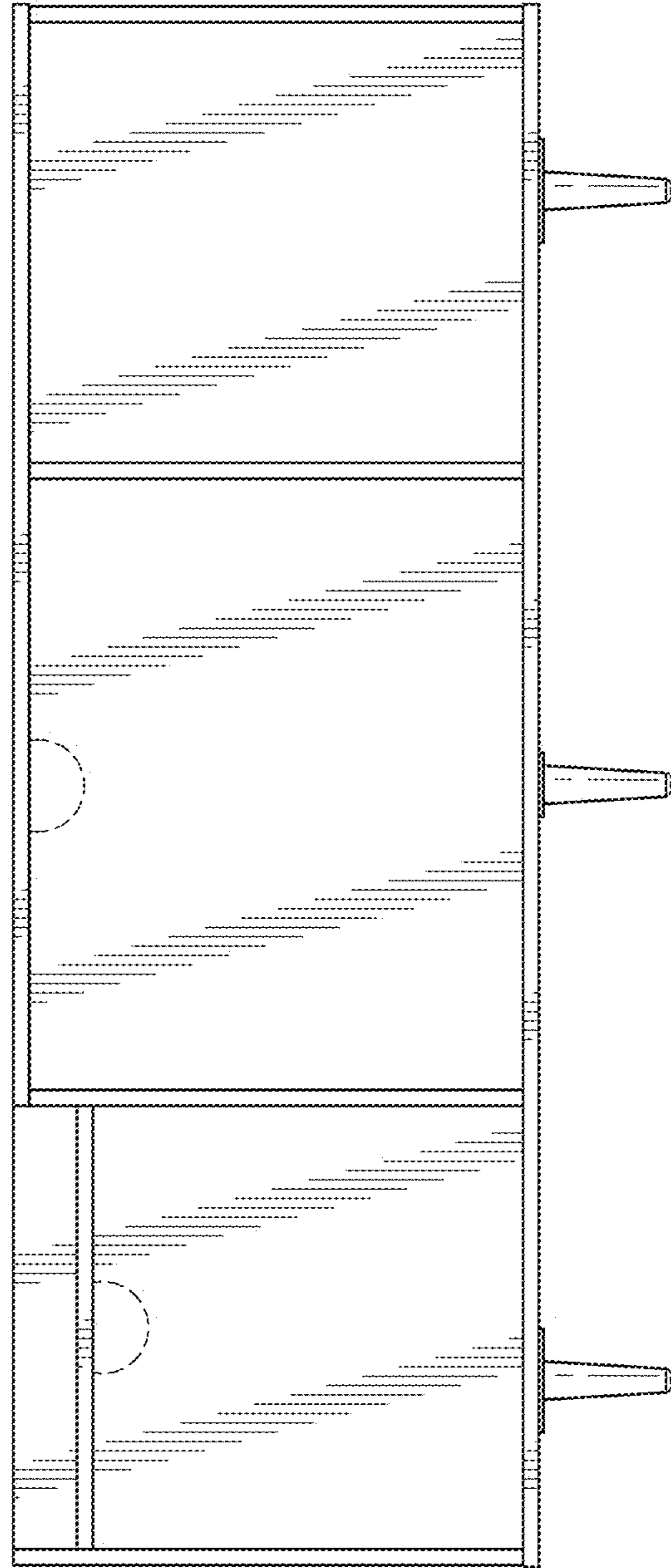

FIG. 3

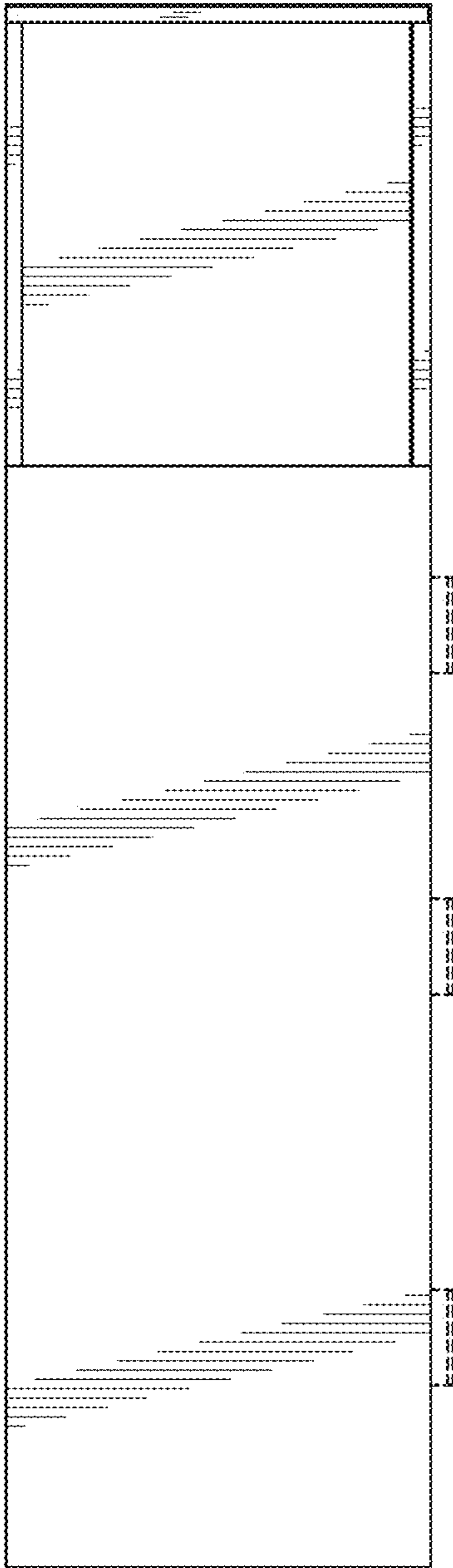

FIG. 4

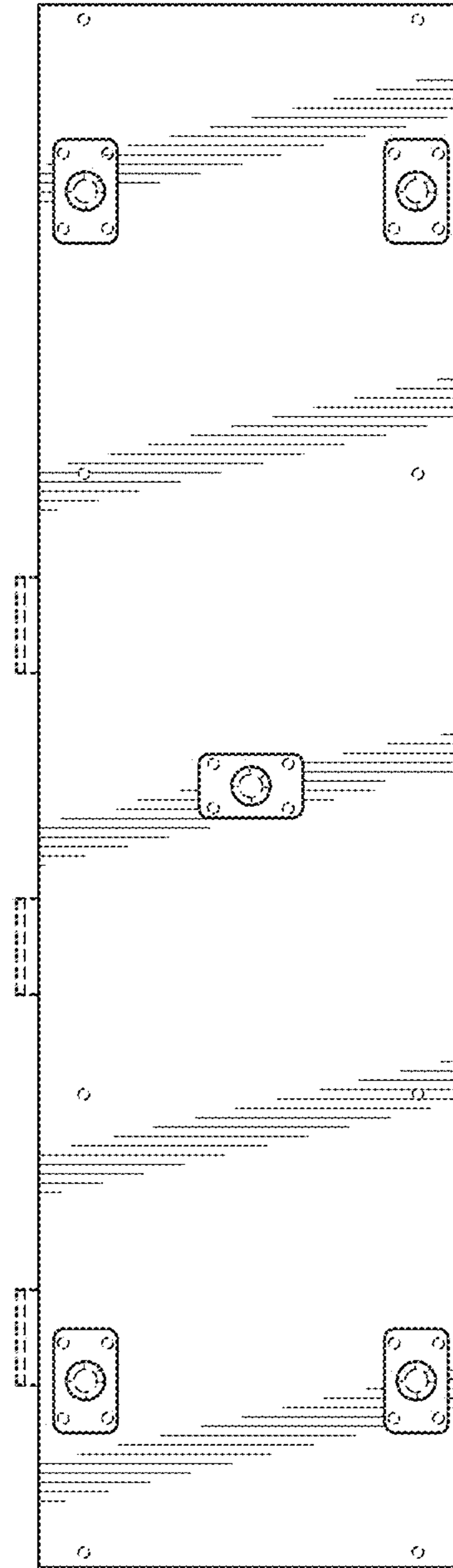

FIG. 5

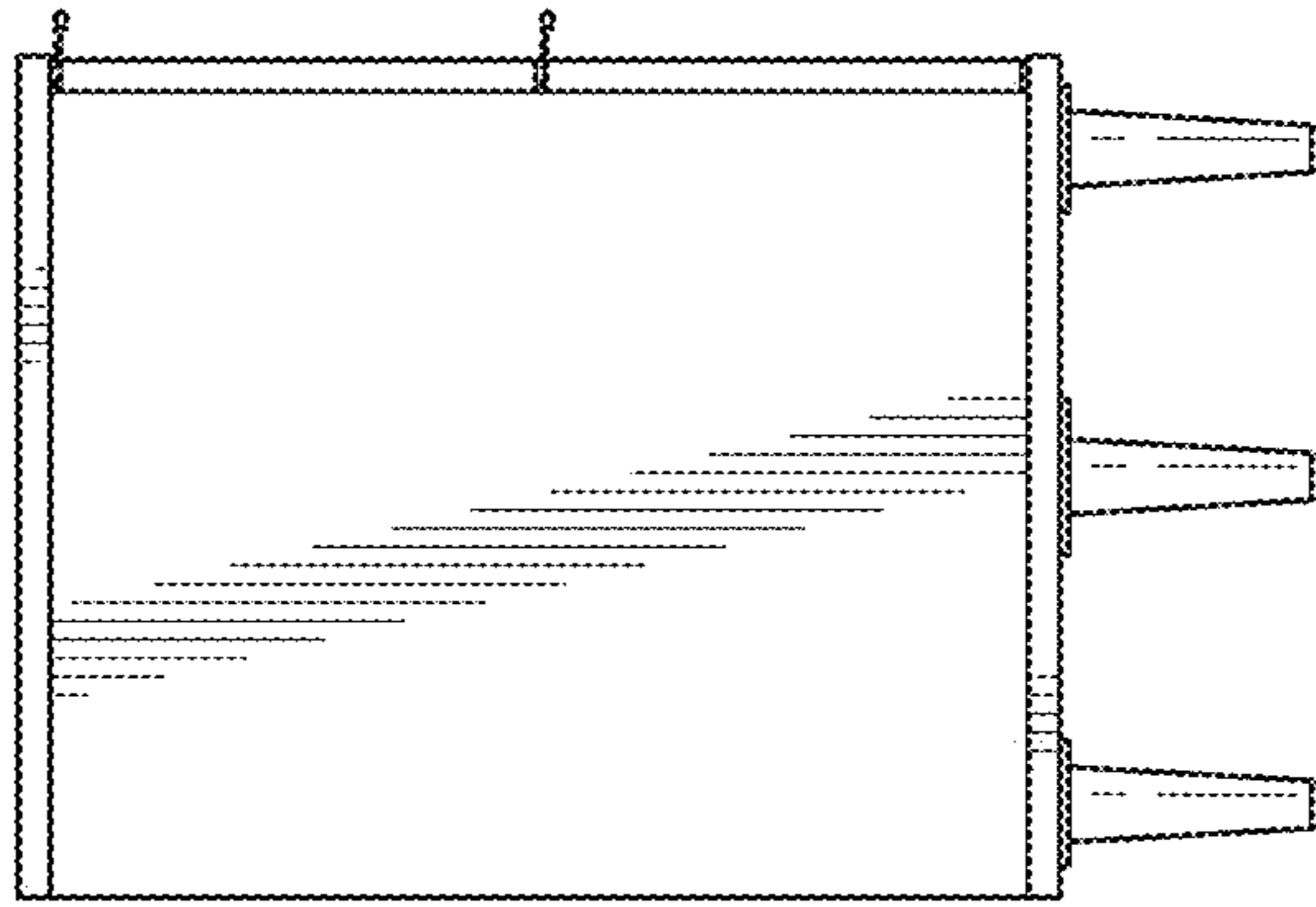

FIG. 7

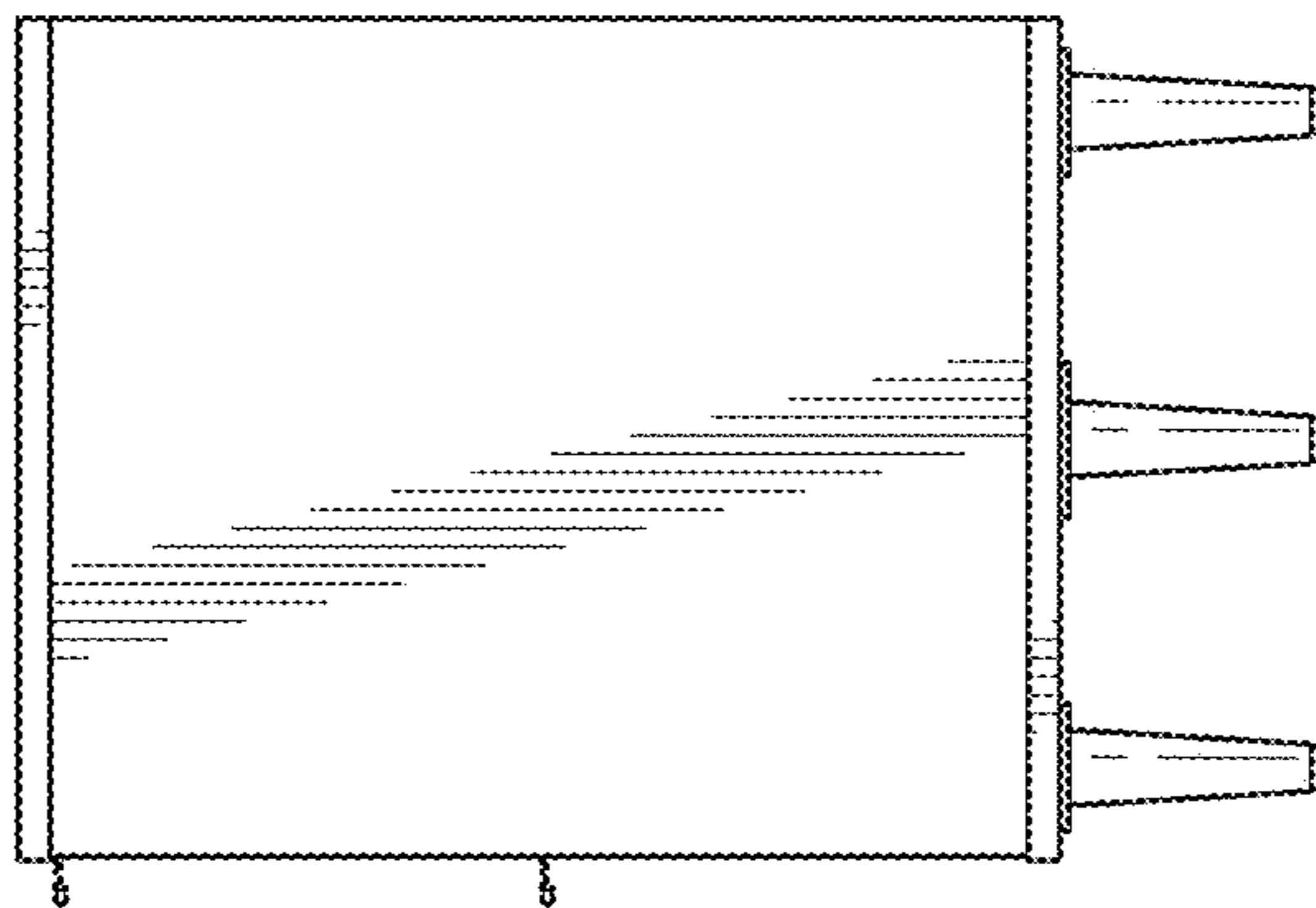

FIG. 6