



US00D931002S

(12) **United States Design Patent** (10) **Patent No.:** **US D931,002 S**
Lee et al. (45) **Date of Patent:** **** Sep. 21, 2021**

(54) **BENCH FOR BUS SHELTER**
(71) Applicant: **LG ELECTRONICS INC.**, Seoul (KR)
(72) Inventors: **Yoonji Lee**, Seoul (KR); **Nayeoung Kim**, Seoul (KR); **Miju Kim**, Seoul (KR); **Jaeyong Park**, Seoul (KR); **Junhee Yeo**, Seoul (KR); **Junghoon Lee**, Seoul (KR)

D781,086 S * 3/2017 Velez D6/691
D789,703 S * 6/2017 Qiao A47C 7/70
D6/406.3
D802,311 S * 11/2017 Stricklin D6/349
D816,358 S * 5/2018 Levine D6/349
D821,340 S * 6/2018 Kim D14/125
D828,705 S * 9/2018 Yoshida D6/656.15
D836,930 S * 1/2019 Levine D6/349
D895,311 S * 9/2020 Kimmel D6/349

(Continued)

(73) Assignee: **LG ELECTRONICS INC.**, Seoul (KR)

(**) Term: **15 Years**

(21) Appl. No.: **29/723,583**

(22) Filed: **Feb. 7, 2020**

(30) **Foreign Application Priority Data**

Sep. 9, 2019 (KR) 30-2019-0043504

(51) **LOC (13) Cl.** **06-01**

(52) **U.S. Cl.**
USPC **D6/349; D6/381**

(58) **Field of Classification Search**
USPC D6/334-338, 349, 351, 353, 369, 370,
D6/371, 374, 376, 377, 381, 673, 675,
D6/691, 691.1, 691.9, 692.5, 709, 709.2,
D6/712, 716, 716.1, 717
CPC A47C 11/00; A47C 13/00; A47C 16/02-04
See application file for complete search history.

(56) **References Cited**

U.S. PATENT DOCUMENTS

D300,996 S * 5/1989 Colby D6/690
D347,533 S * 6/1994 Lambert D24/190
D472,069 S * 3/2003 Sedor D6/652
D600,460 S * 9/2009 Schwartz D6/355
D763,585 S * 8/2016 Morozan D6/335
D774,807 S * 12/2016 Biddle D6/691

OTHER PUBLICATIONS

Ansan Installs Heated Seats at Local Bus Stops. [online] Published on Nov. 12, 2019. Retrieved Jul. 21, 2021 from URL: <http://koreabizwire.com/ansan-installs-heated-seats-at-local-bus-stops/147591>.*

(Continued)

Primary Examiner — Vy N Koenig

(74) *Attorney, Agent, or Firm* — Birch, Stewart, Kolasch & Birch LLP

(57) **CLAIM**

We claim the ornamental design for a bench for bus shelter, as shown and described.

DESCRIPTION

FIG. 1 is a perspective view of a bench for bus shelter showing the new design;
FIG. 2 is a front elevation view thereof;
FIG. 3 is a rear elevation view thereof;
FIG. 4 is a left-side elevation view thereof;
FIG. 5 is a right-side elevation view thereof;
FIG. 6 is a top plan view thereof;
FIG. 7 is a bottom plan view thereof; and,
FIG. 8 is a perspective view thereof, shown in a use condition.
Broken lines illustrate environmental condition only and form no part of the claimed design.

1 Claim, 8 Drawing Sheets

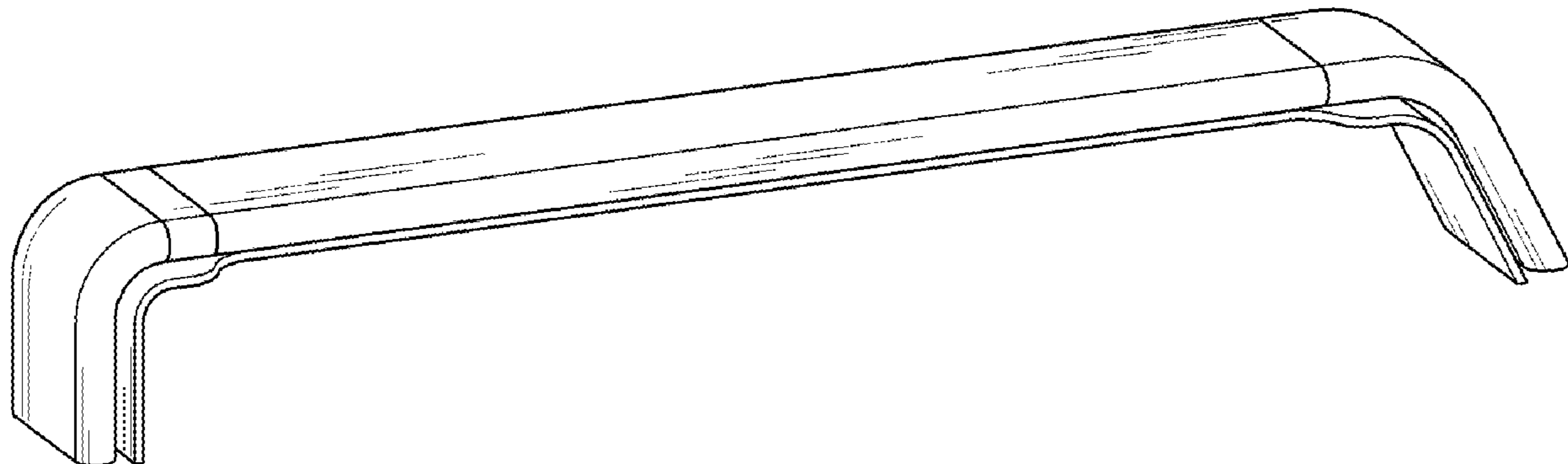

(56)

References Cited

U.S. PATENT DOCUMENTS

D896,011 S * 9/2020 Velez D6/691
D903,380 S * 12/2020 Stevens D6/656

OTHER PUBLICATIONS

China Modern Technology Digital Bus Shelter. [online] Retrieved Jul. 21, 2021 from URL: <https://cnyceroo.en.made-in-china.com/productimage/EFpQrvZAJIWG-2flj00IKDRiQtcFabE/China-Modern-Technology-Digital-Bus-Shelter-and-Intelligent-Reporting-Bus-Station-Customization.html>.*

29723583_OrbitForeignRefs.pdf. Design © Questel orbit.com. [Online PDF compilation of references selected by examiner] 20 pgs. Retrieved Jul. 22, 2021 from URL: <https://www.orbit.com/export/QPTUJ190/pdf2/f75c3555-59d9-4c4b-928b-bffa0f924383-161837.pdf>.*

* cited by examiner

FIG. 1

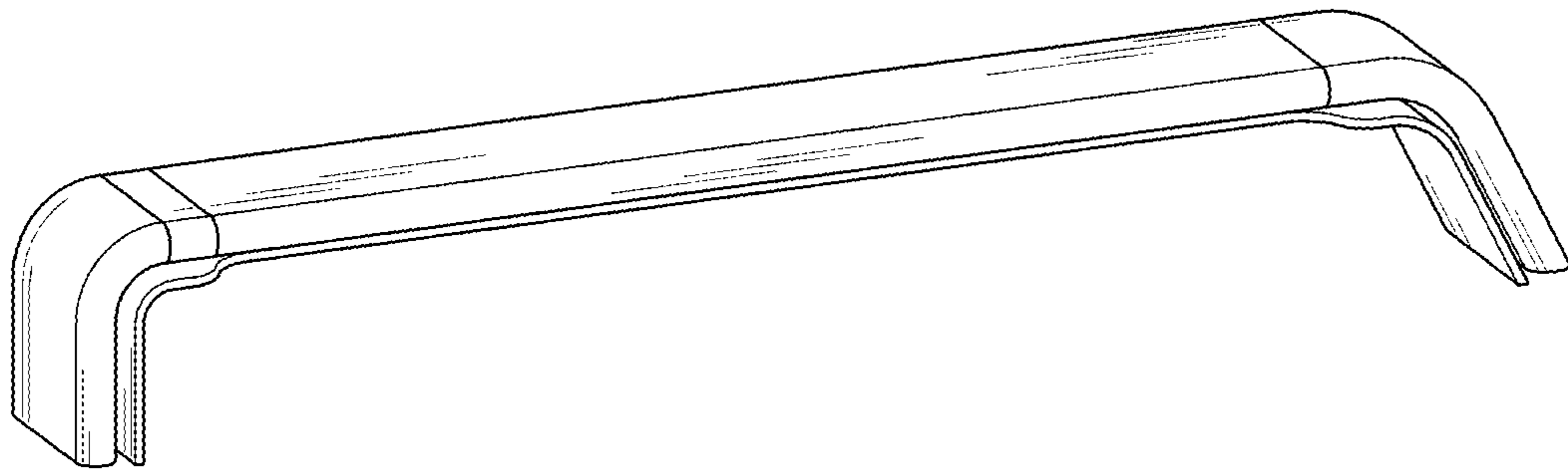

FIG. 2

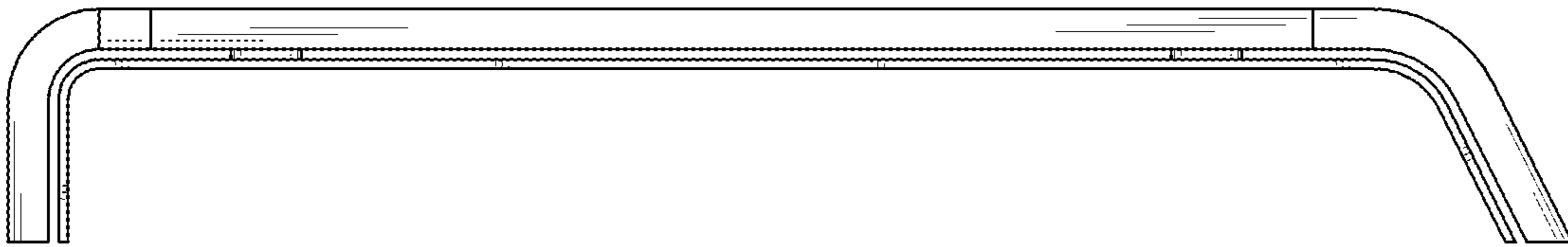

FIG. 3

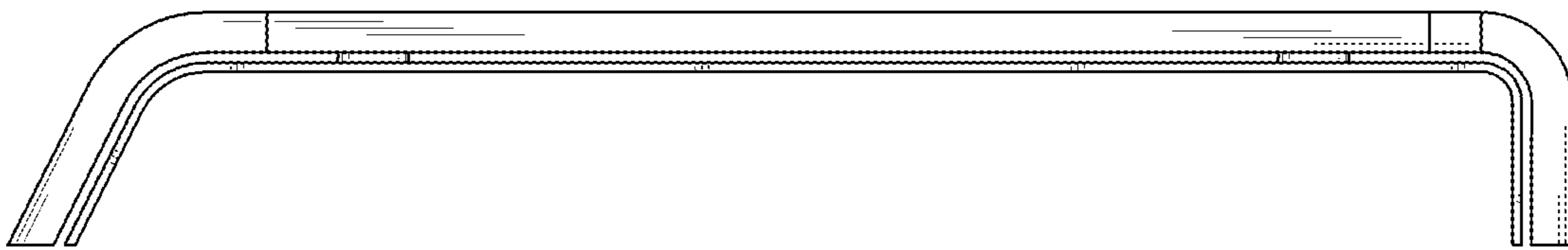

FIG. 4

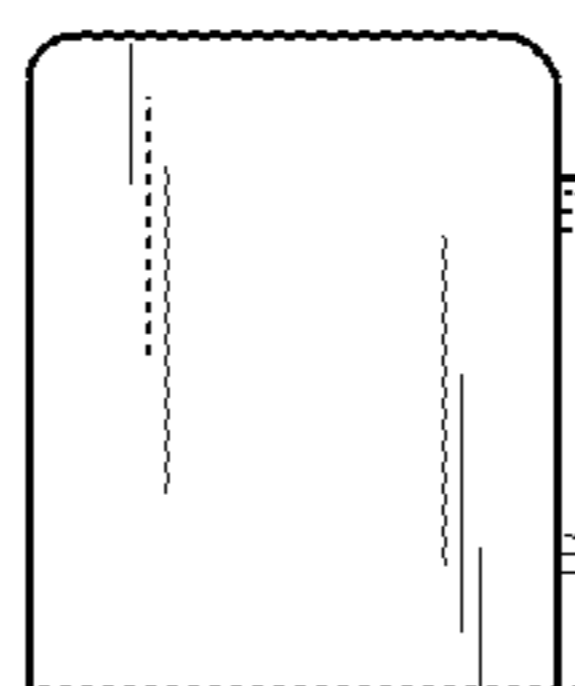

FIG. 5

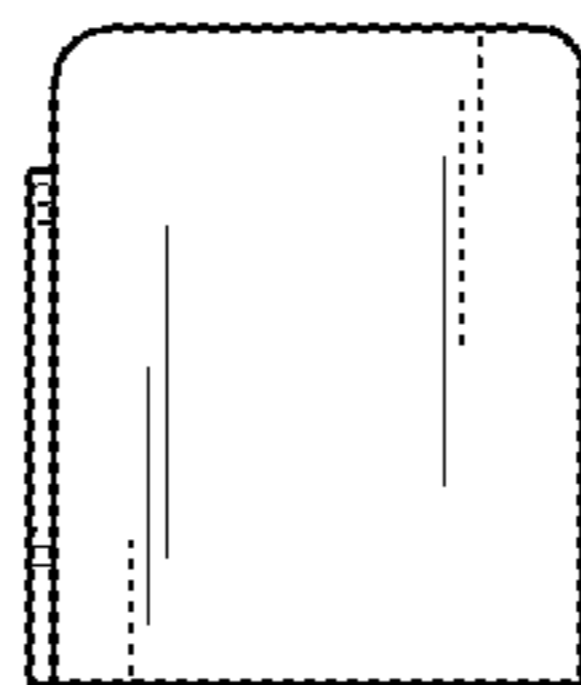

FIG. 6

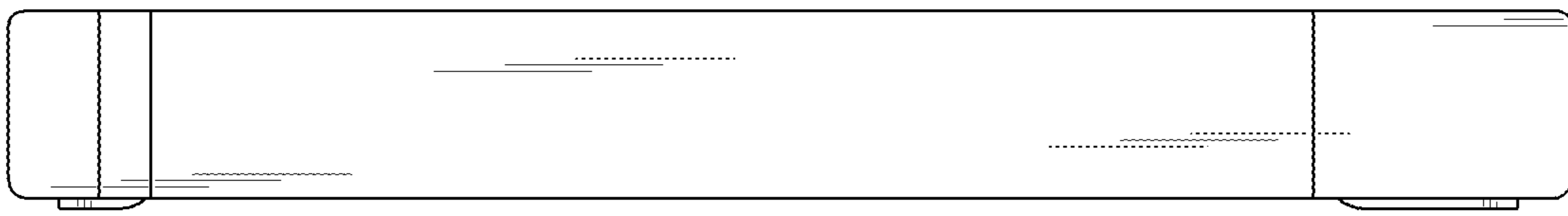

FIG. 7

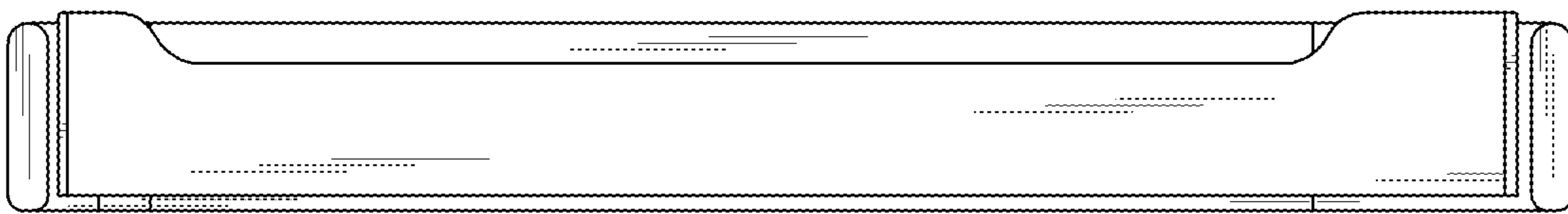

FIG. 8

