



US00D930920S

(12) **United States Design Patent** (10) **Patent No.:** **US D930,920 S**
Ryan (45) **Date of Patent:** **** Sep. 14, 2021**

- (54) **CAT SCRATCHER**
- (71) Applicant: **Wiski LLC**, Chicago, IL (US)
- (72) Inventor: **Evan L. Ryan**, Chicago, IL (US)
- (73) Assignee: **WISKI LLC**, Westport, CT (US)
- (**) Term: **15 Years**
- (21) Appl. No.: **29/738,230**
- (22) Filed: **Jun. 16, 2020**

Related U.S. Application Data

- (62) Division of application No. 29/640,683, filed on Mar. 16, 2018, now Pat. No. Des. 894,504.
- (51) **LOC (13) Cl.** **30-99**
- (52) **U.S. Cl.**
USPC **D30/158**
- (58) **Field of Classification Search**
USPC D30/161, 124-128, 108-120, 158-160
CPC A01K 1/011; A01K 1/0107; A01K 1/0125;
A01K 1/0121; A47K 13/00; A47K 13/06;
A47K 13/14; A47K 11/02; A47K 11/06
See application file for complete search history.

(56) **References Cited**

U.S. PATENT DOCUMENTS

D466,749 S	*	12/2002	O'Quinn	D6/601
D589,657 S	*	3/2009	Lamstein	D30/118
D627,110 S	*	11/2010	Seliskar	D30/160
D644,795 S	*	9/2011	Haaf	D30/160
D651,371 S	*	12/2011	Seliskar	D30/118
D652,182 S	*	1/2012	Seliskar	D30/118
D655,463 S	*	3/2012	Seliskar	D30/118
D655,464 S	*	3/2012	Seliskar	D30/118
D864,612 S	*	10/2019	Castellano	D6/601

* cited by examiner

Primary Examiner — Sheryl Lane
Assistant Examiner — Aula Soroush
(74) *Attorney, Agent, or Firm* — Zollinger & Burleson Ltd.

(57) **CLAIM**

The ornamental design for a cat scratcher, as shown and described.

DESCRIPTION

FIG. 1 is a perspective view of a first embodiment of the cat scratcher showing my new design.
 FIG. 2 is a front elevation view thereof.
 FIG. 3 is a top plan view of thereof.
 FIG. 4 is a left side elevation view thereof.
 FIG. 5 is a right side elevation view thereof.
 FIG. 6 is a rear elevation view thereof.
 FIG. 7 is a bottom plan view thereof.
 FIG. 8 is a perspective view of a second embodiment of the cat scratcher showing my new design.
 FIG. 9 is a front elevation view thereof.
 FIG. 10 is a top plan view of thereof.
 FIG. 11 is a left side elevation view thereof.
 FIG. 12 is a right side elevation view thereof.
 FIG. 13 is a rear elevation view thereof.
 FIG. 14 is a bottom plan view thereof.
 FIG. 15 is a perspective view of a third embodiment of the cat scratcher showing my new design.
 FIG. 16 is a front elevation view thereof.
 FIG. 17 is a top plan view of thereof.
 FIG. 18 is a left side elevation view thereof.
 FIG. 19 is a right side elevation view thereof.
 FIG. 20 is a rear elevation view thereof; and,
 FIG. 21 is a bottom plan view thereof.
 The features depicted in broken lines form no part of the claimed design.

1 Claim, 12 Drawing Sheets

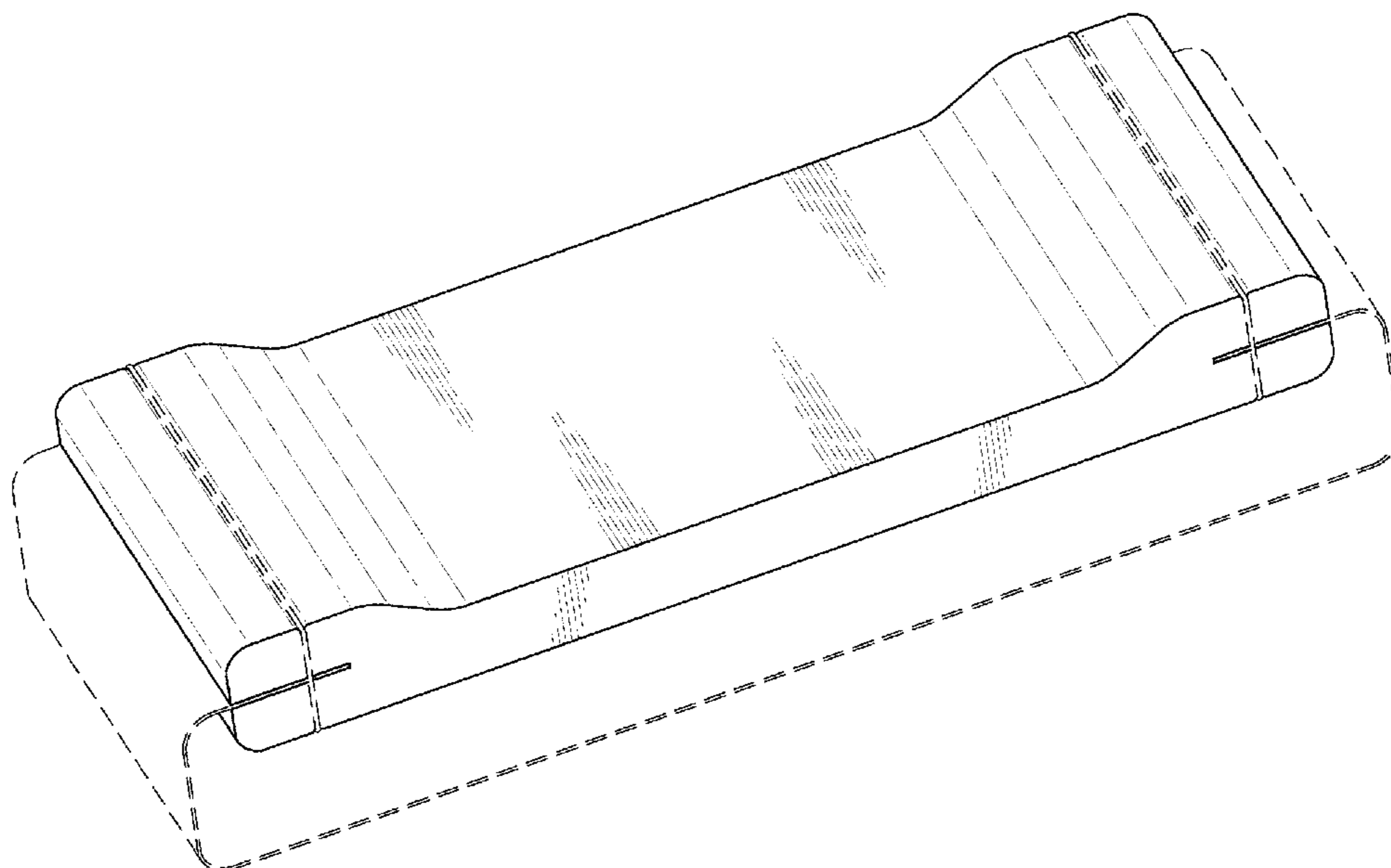

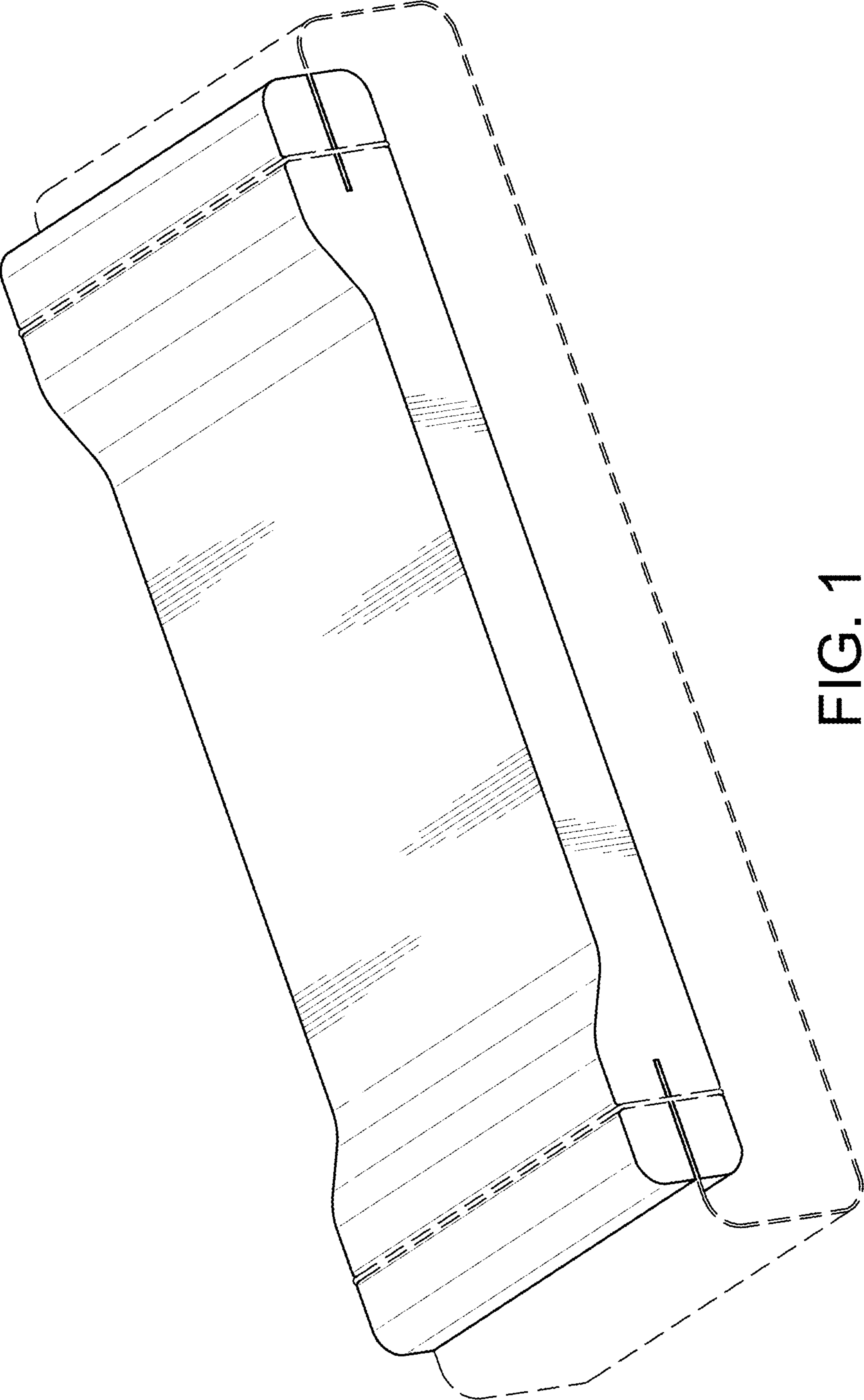

FIG. 1

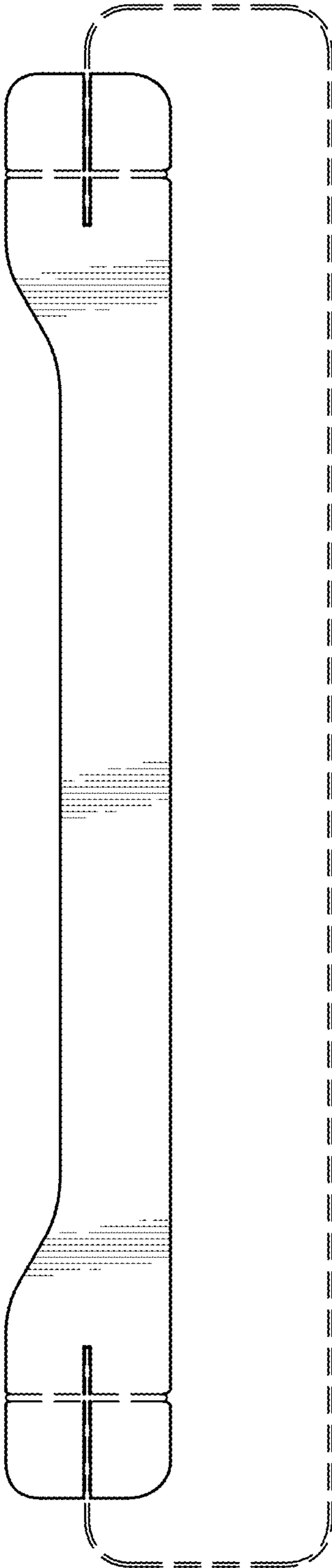

FIG. 2

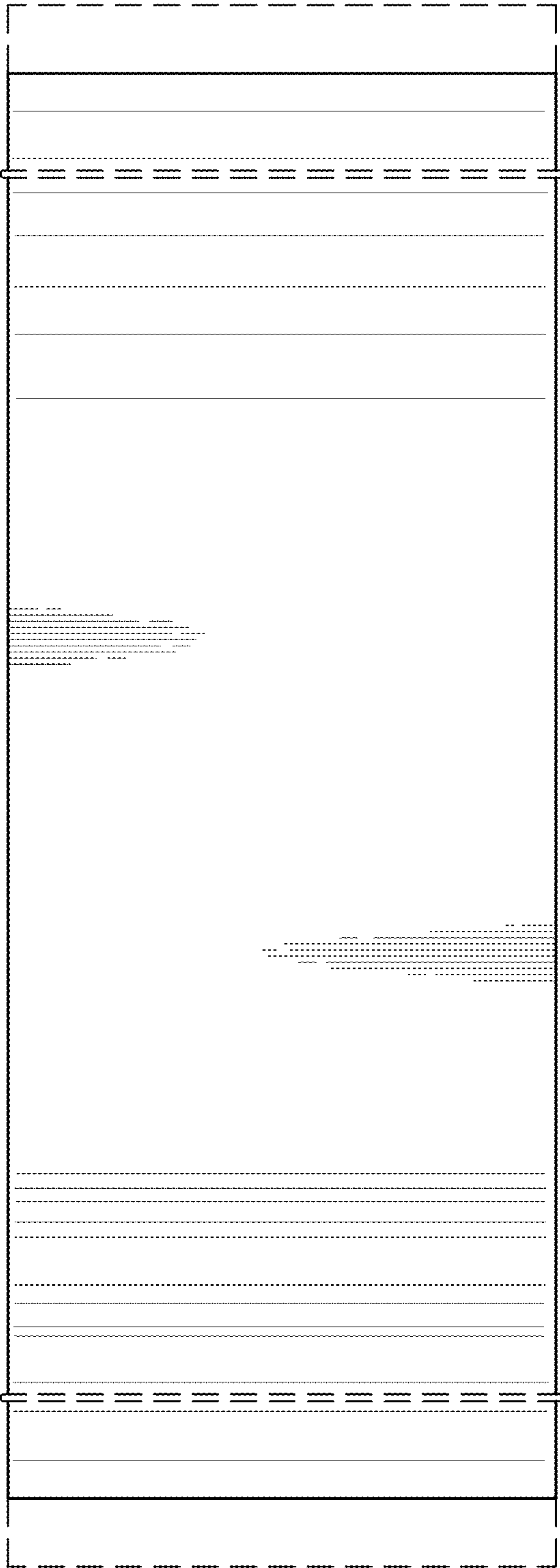

FIG. 3

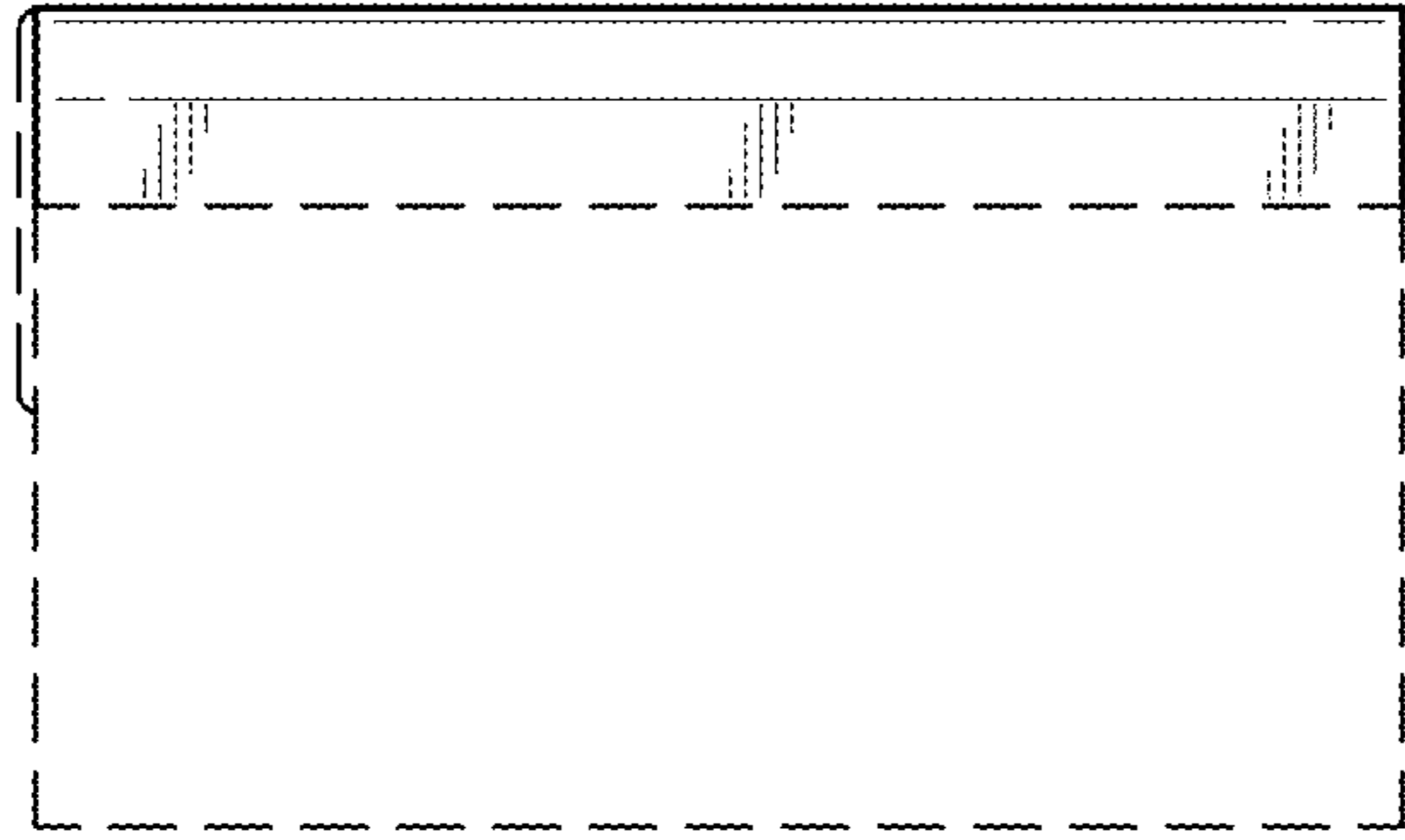

FIG. 4

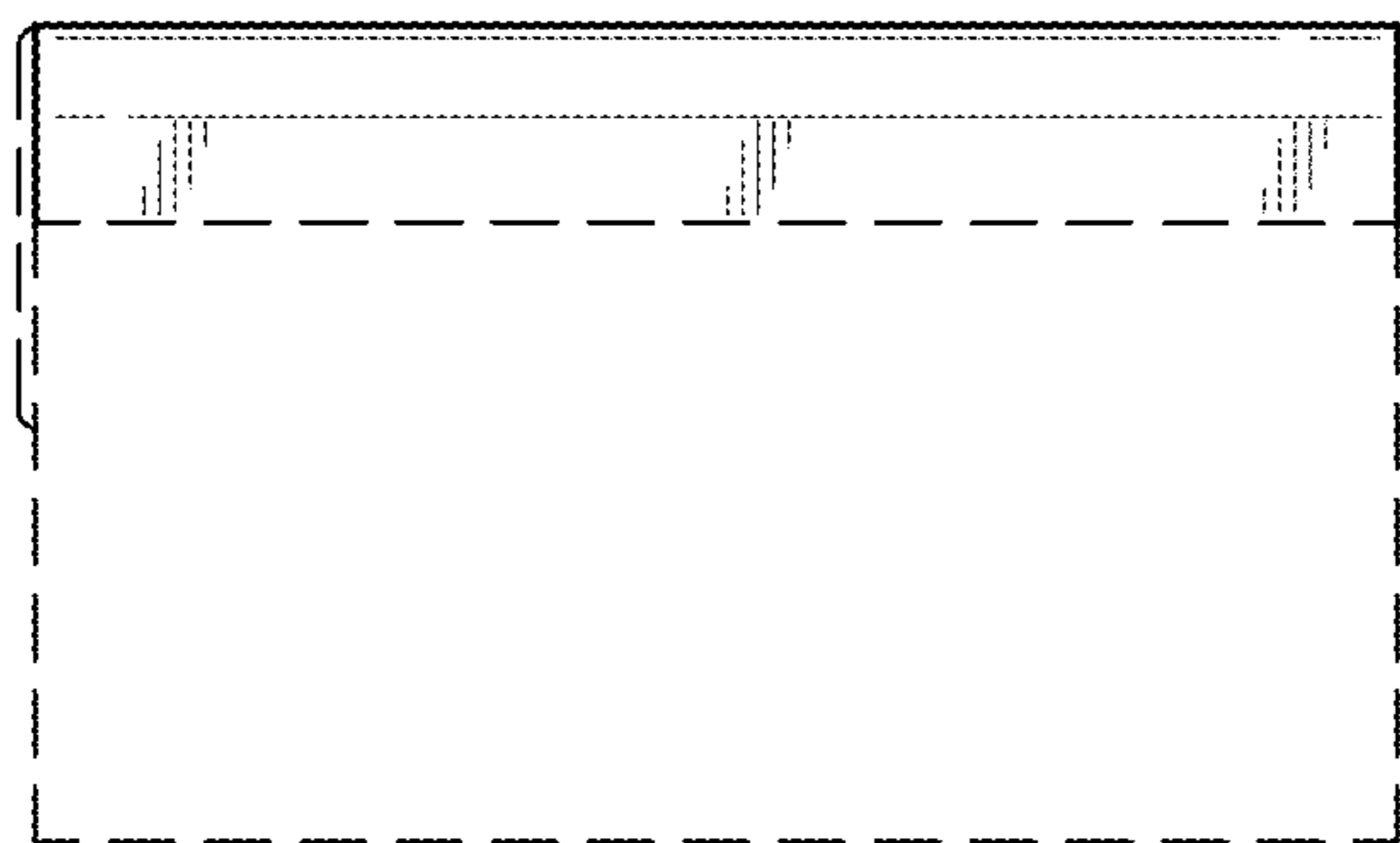

FIG. 5

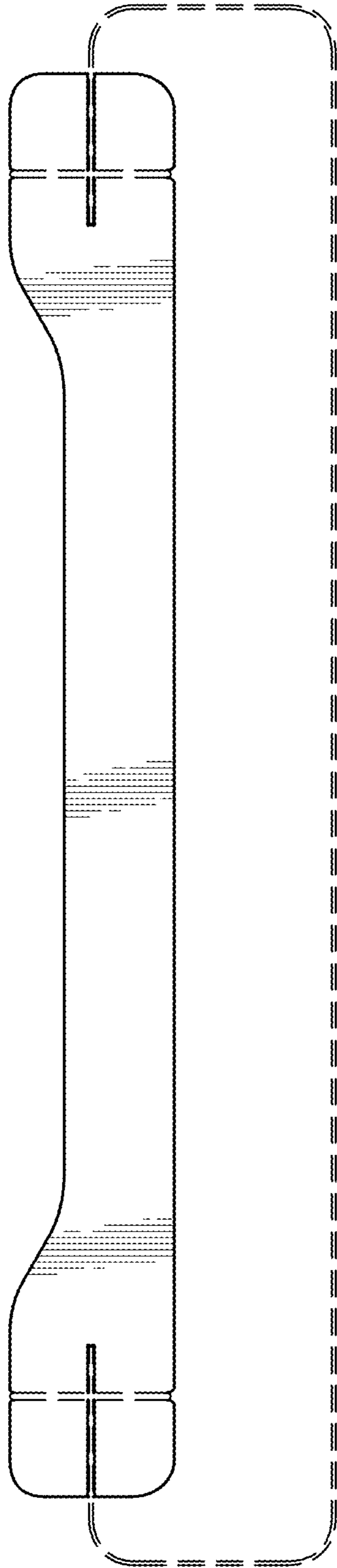

FIG. 6

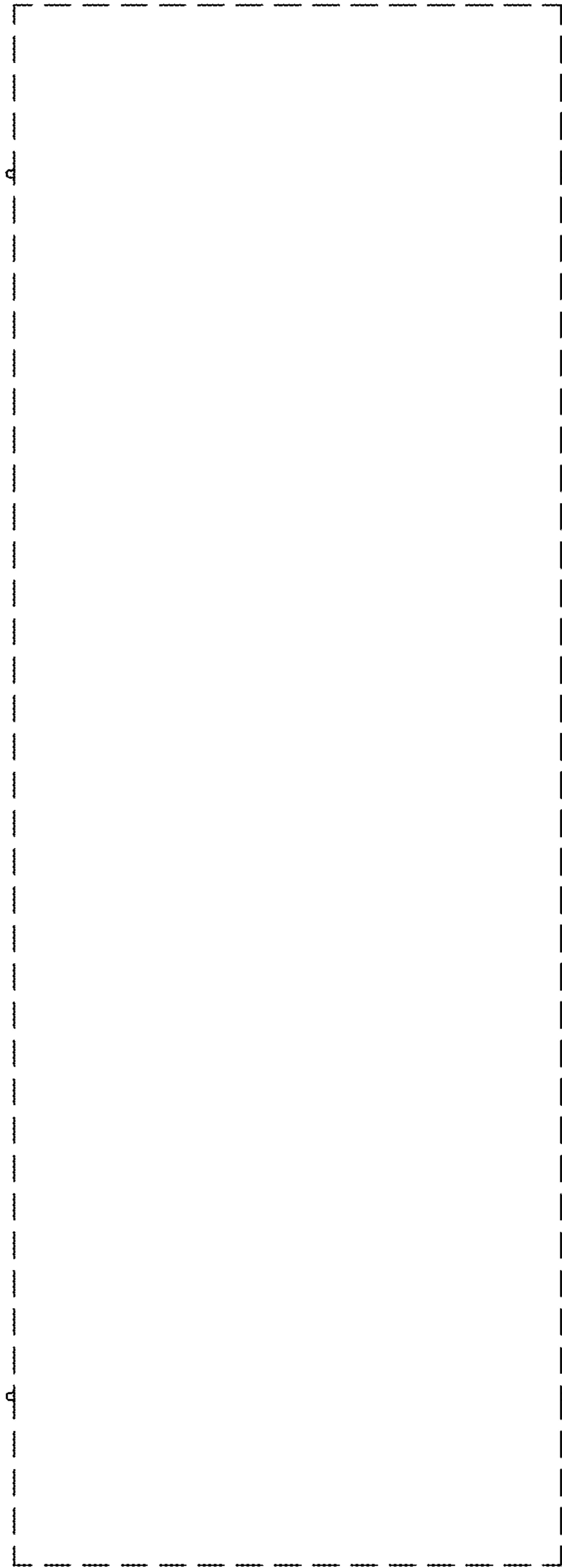

FIG. 7

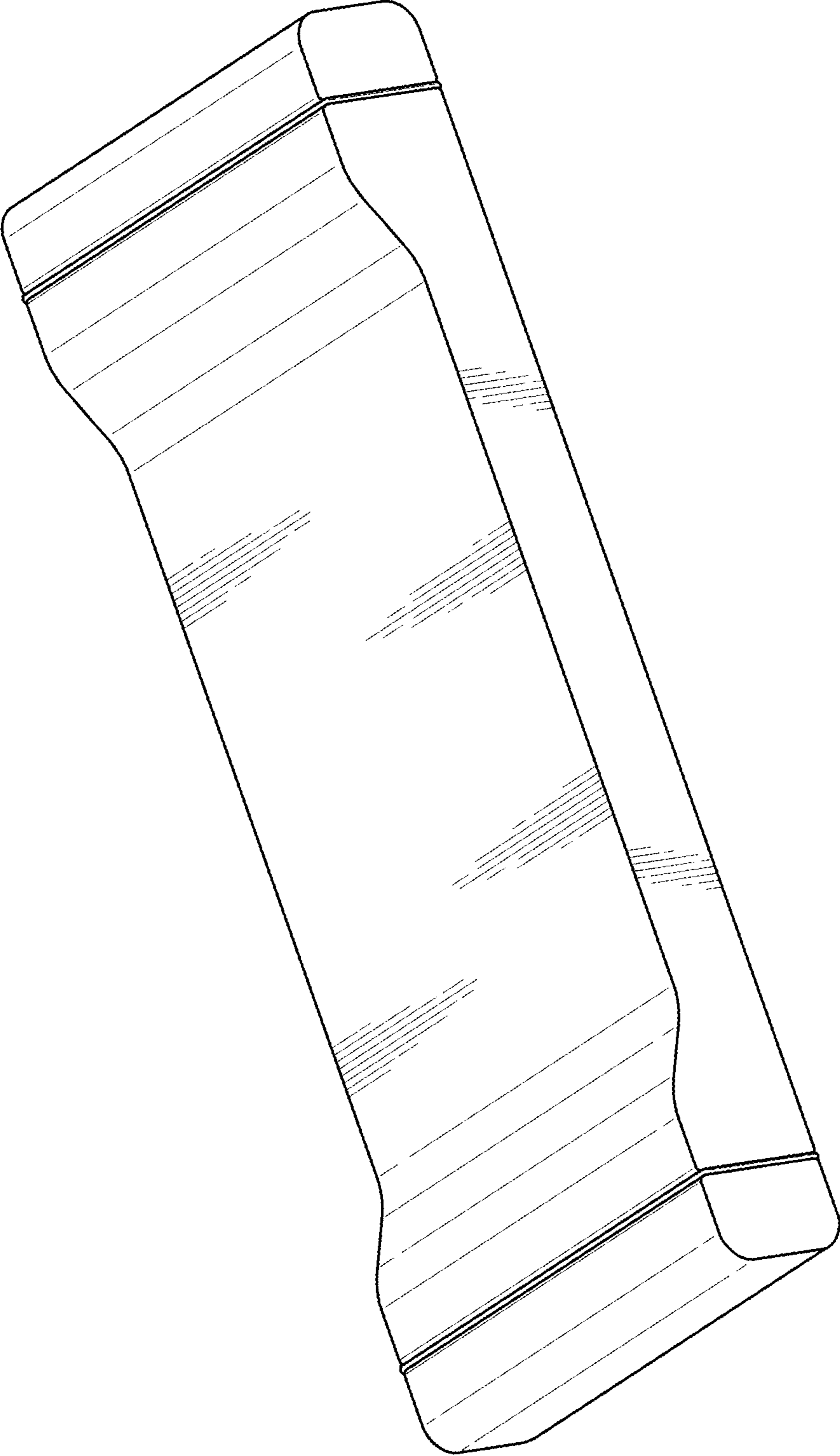

FIG. 8

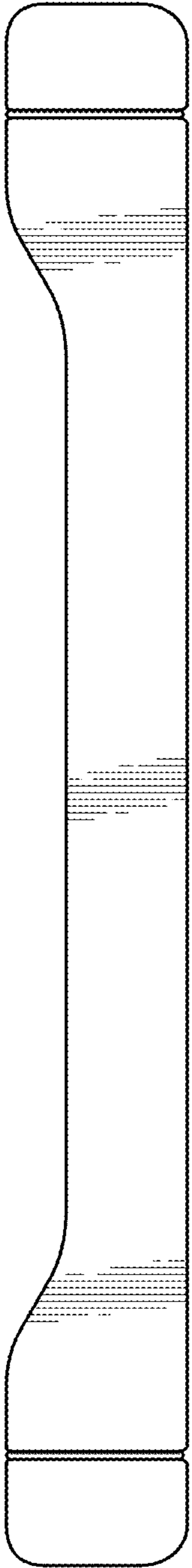

FIG. 9

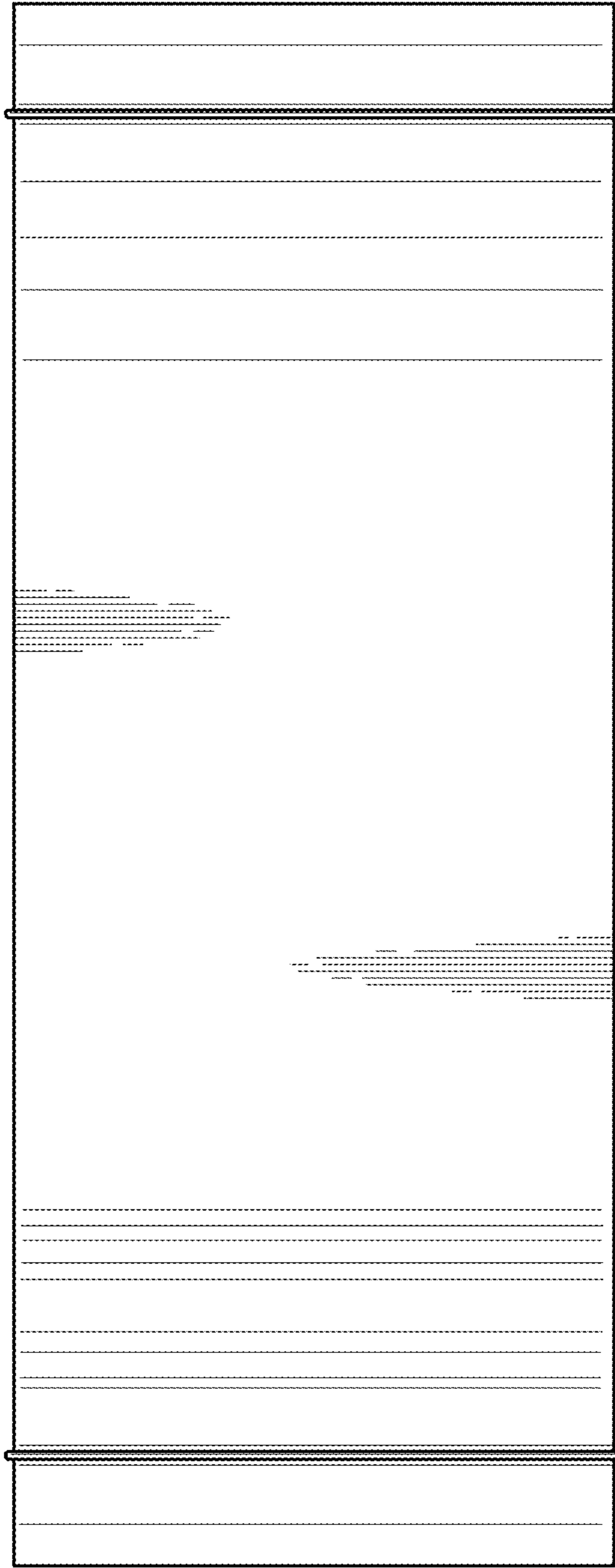

FIG. 10

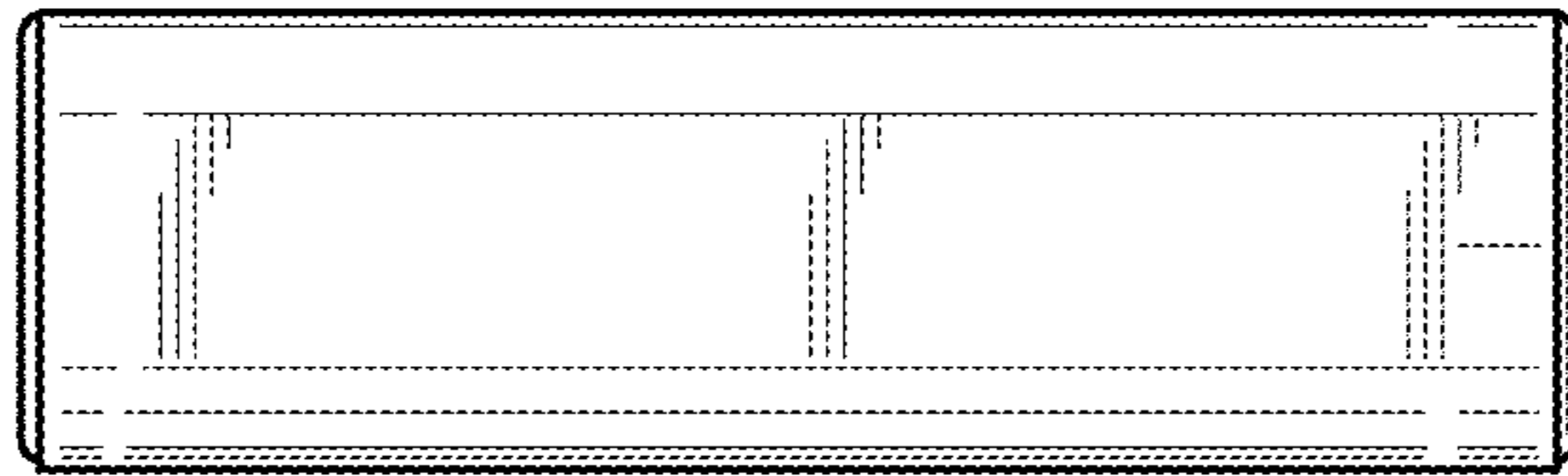

FIG. 11

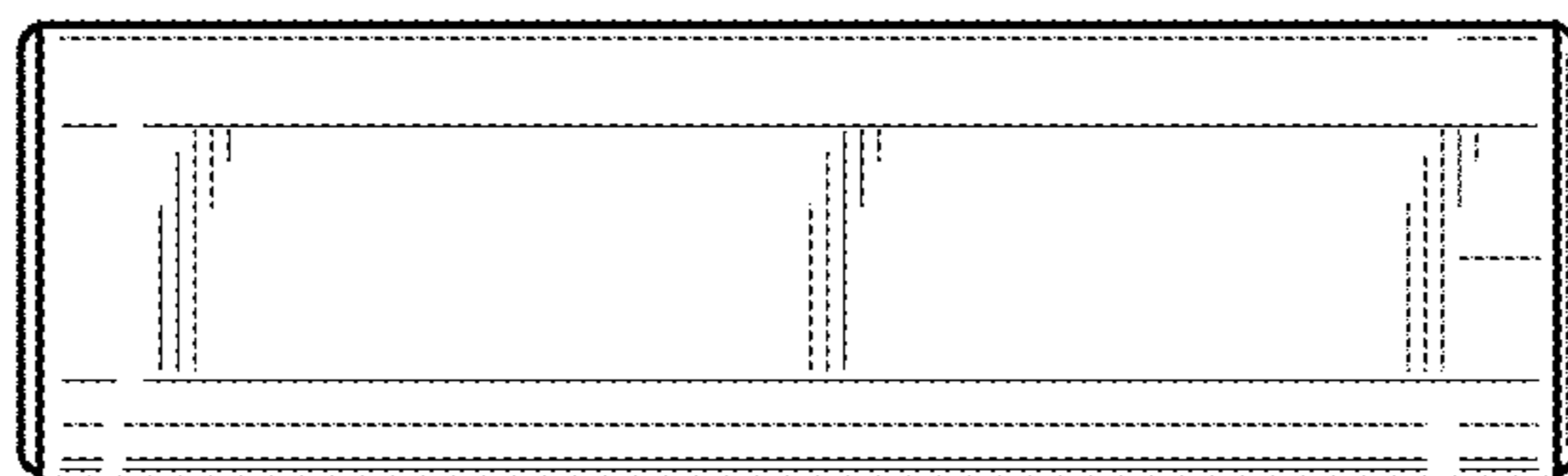

FIG. 12

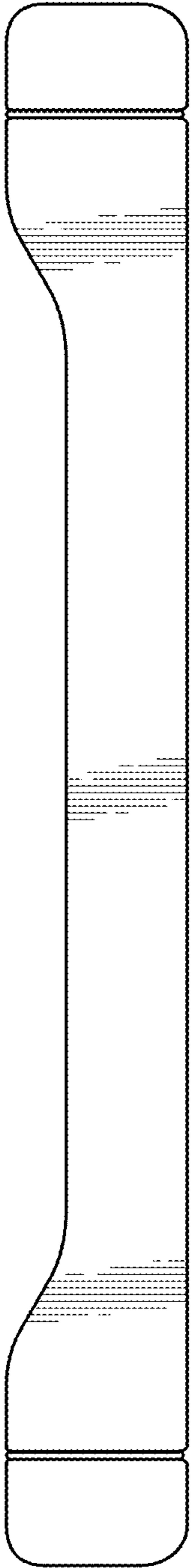

FIG. 13

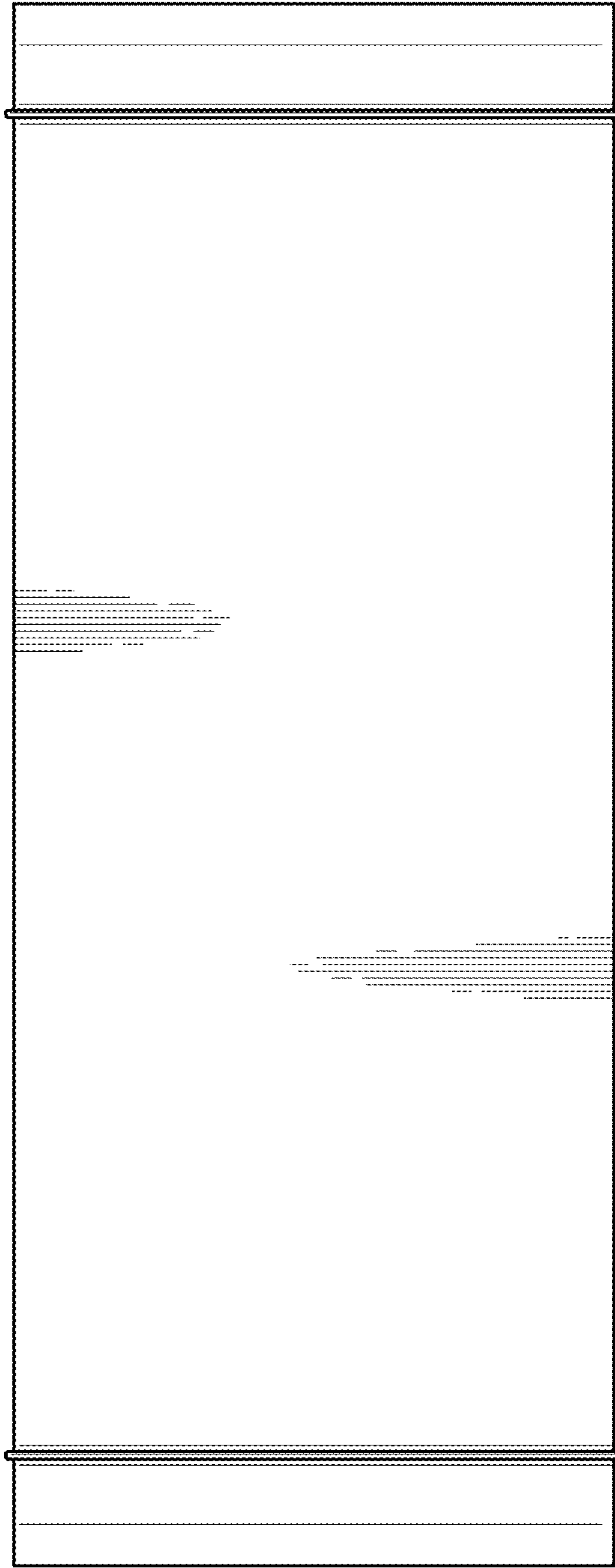

FIG. 14

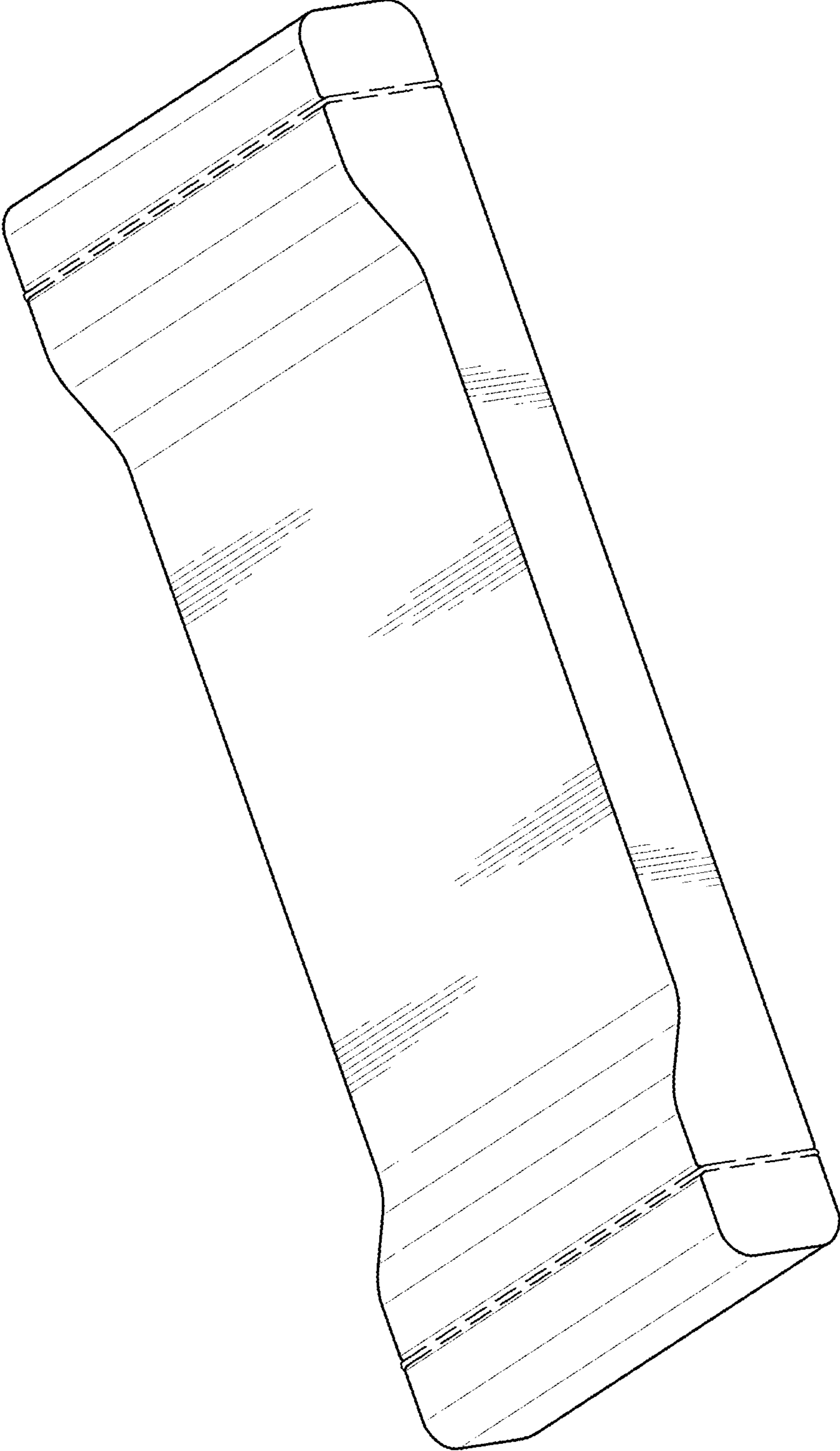

FIG. 15

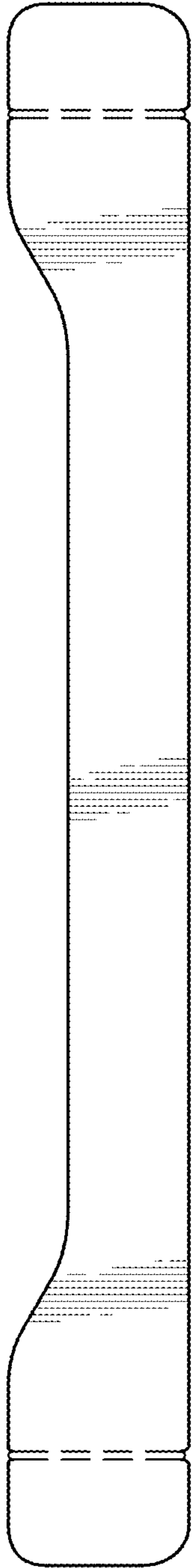

FIG. 16

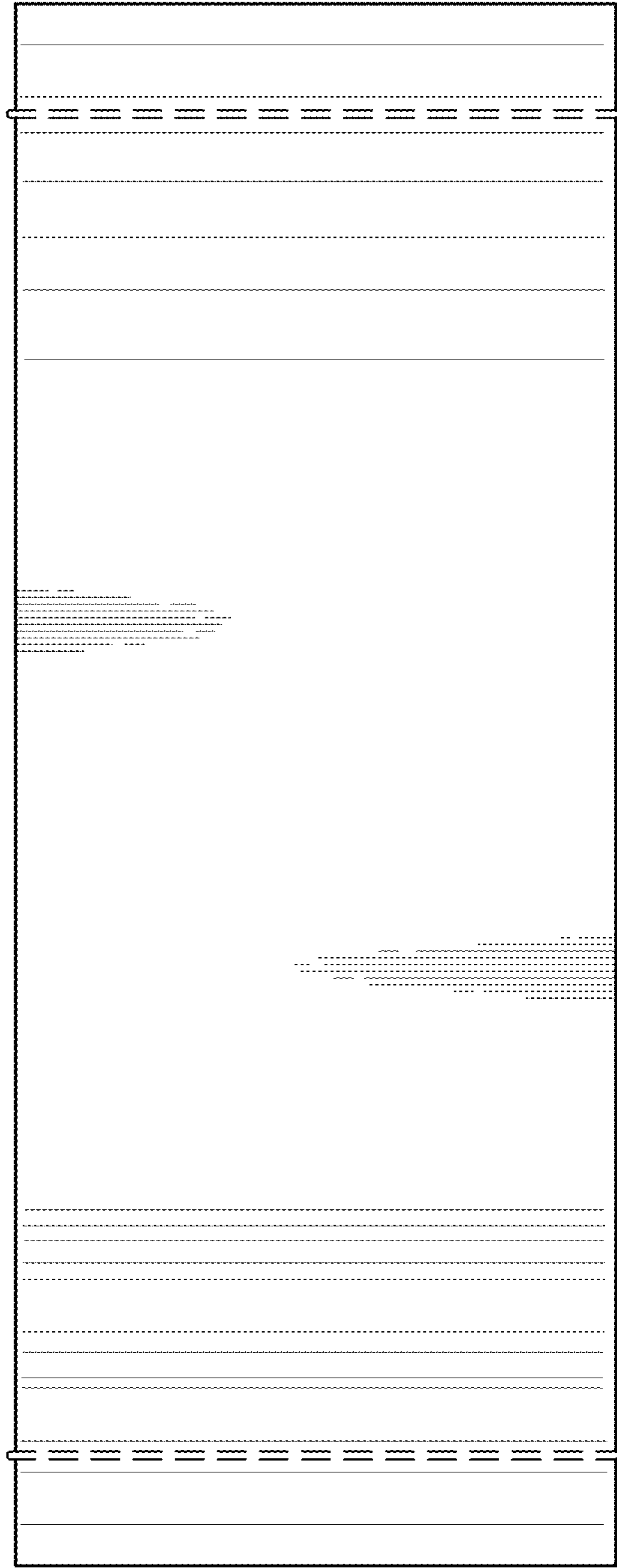

FIG. 17

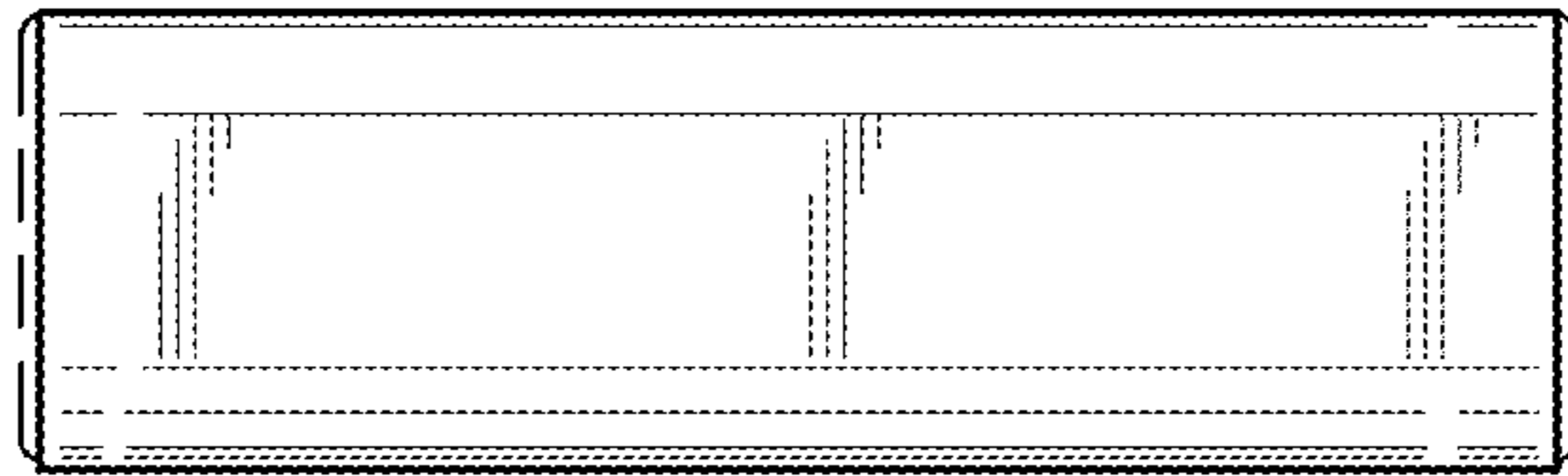

FIG. 18

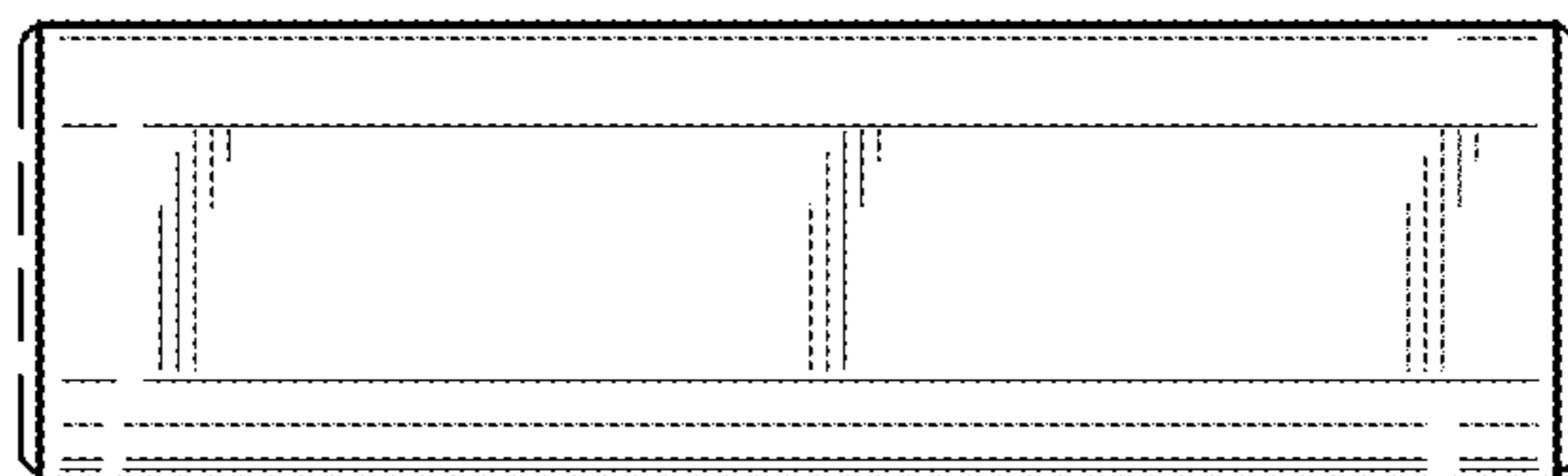

FIG. 19

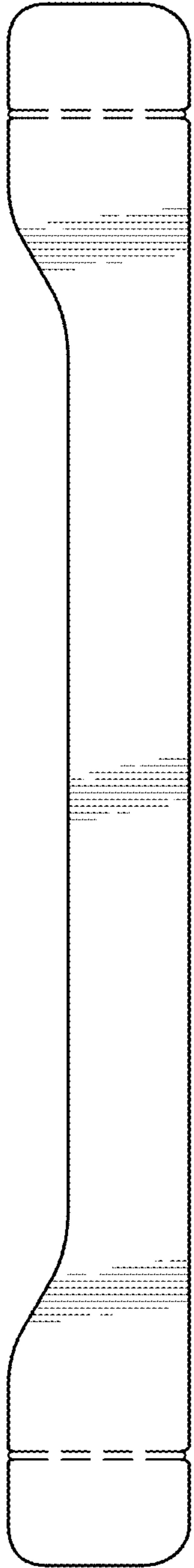

FIG. 20

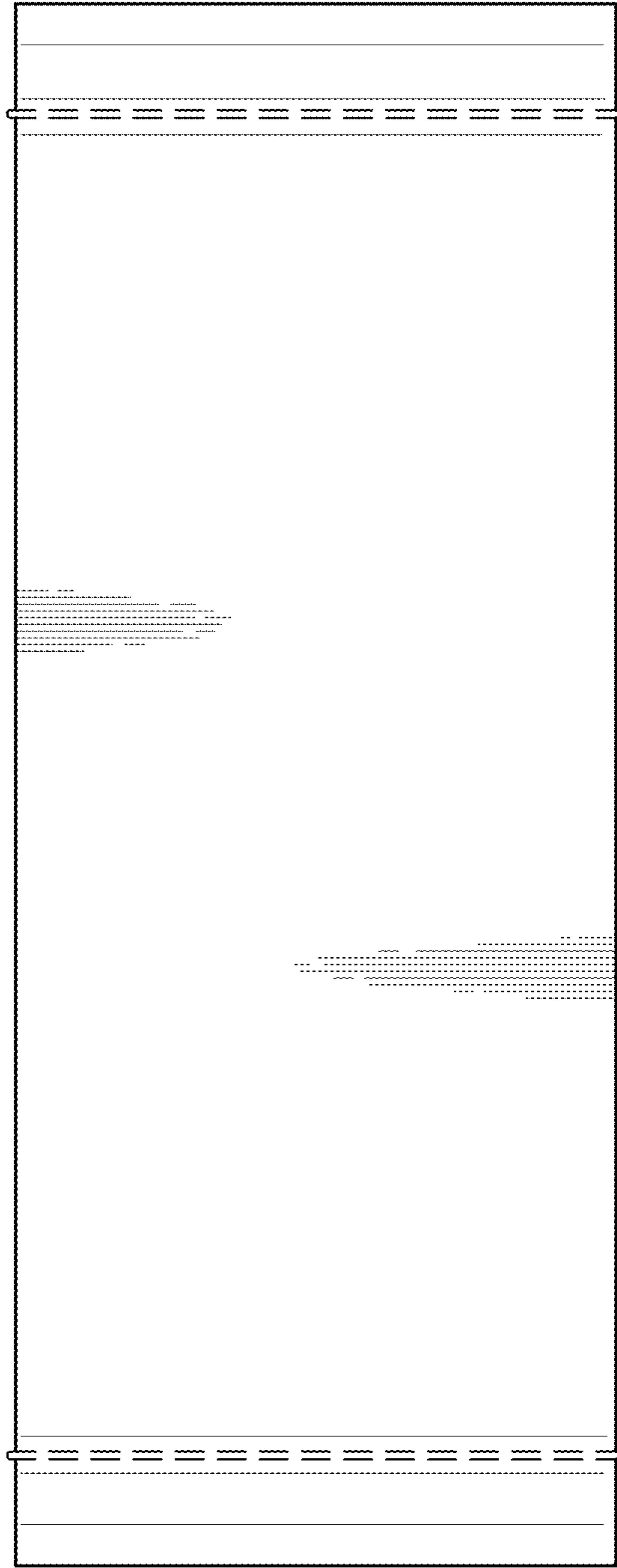

FIG. 21