



US00D930890S

(12) **United States Design Patent**
Schmidt

(10) **Patent No.:** **US D930,890 S**

(45) **Date of Patent:** **** Sep. 14, 2021**

(54) **HORTICULTURAL LUMINAIRE**

(71) Applicant: **Jonathan Becker Schmidt**, Round Rock, TX (US)

(72) Inventor: **Jonathan Becker Schmidt**, Round Rock, TX (US)

(73) Assignee: **Fluence Bioengineering Inc.**, Austin, TX (US)

(**) Term: **15 Years**

(21) Appl. No.: **29/704,029**

(22) Filed: **Aug. 30, 2019**

(51) **LOC (13) Cl.** **26-05**

(52) **U.S. Cl.**
USPC **D26/118**

(58) **Field of Classification Search**
USPC D26/24, 34, 51, 55, 59, 72, 76, 78, 79,
D26/80, 81, 85, 86, 88, 90, 118, 120, 138
CPC F21S 8/00; F21S 8/04; F21S 8/08; F21S
8/026; F21S 8/043; F21S 8/066; F21S
8/081; F21S 8/083; F21S 8/085; F21S
8/088; F21V 15/00; F21V 15/01; F21V
21/00; F21V 21/02; F21V 21/005; F21V
21/041; F21V 21/048; F21V 21/049;
F21V 7/00; F21V 7/0008; F21V 9/30
See application file for complete search history.

(56) **References Cited**

U.S. PATENT DOCUMENTS

D603,089 S * 10/2009 Uchida D26/138
D649,677 S * 11/2011 Wegger D26/90
D695,943 S * 12/2013 Duquette D26/87

D731,103 S * 6/2015 Wilke D26/72
D875,988 S * 2/2020 Bou Harb D26/76
D876,700 S * 2/2020 Patterson D26/76
D898,976 S * 10/2020 Xu D26/76
D903,178 S * 11/2020 Porciatti D26/76
D903,925 S * 12/2020 Meise D26/76
D909,654 S * 2/2021 Sokol D26/76
10,962,181 B2 * 3/2021 Sonneman F21S 8/06
D915,631 S * 4/2021 Patterson D25/138
D916,348 S * 4/2021 Clark D26/72
D917,079 S * 4/2021 Patterson D25/138

* cited by examiner

Primary Examiner — Wan Laymon

Assistant Examiner — Clint A Samuel

(74) *Attorney, Agent, or Firm* — Edward Podszus

(57) **CLAIM**

The ornamental design for a horticultural luminaire, as shown and described.

DESCRIPTION

FIG. 1 is a perspective view of the new design for a horticultural luminaire as seen from the top, rear, left side; FIG. 2 is a front elevational view thereof, the rear view being identical; FIG. 3 is a top plan view thereof; FIG. 4 is a bottom plan view thereof; FIG. 5 is a right side elevational view thereof; and, FIG. 6 is a left side elevational view thereof. The broken line disclosure is for environmental purposes only and does not form a part of the claimed design. The horticultural luminaire is shown with a symbolic break in its length. The appearance of any portion of the article between the break lines forms no part of the claimed design.

1 Claim, 4 Drawing Sheets

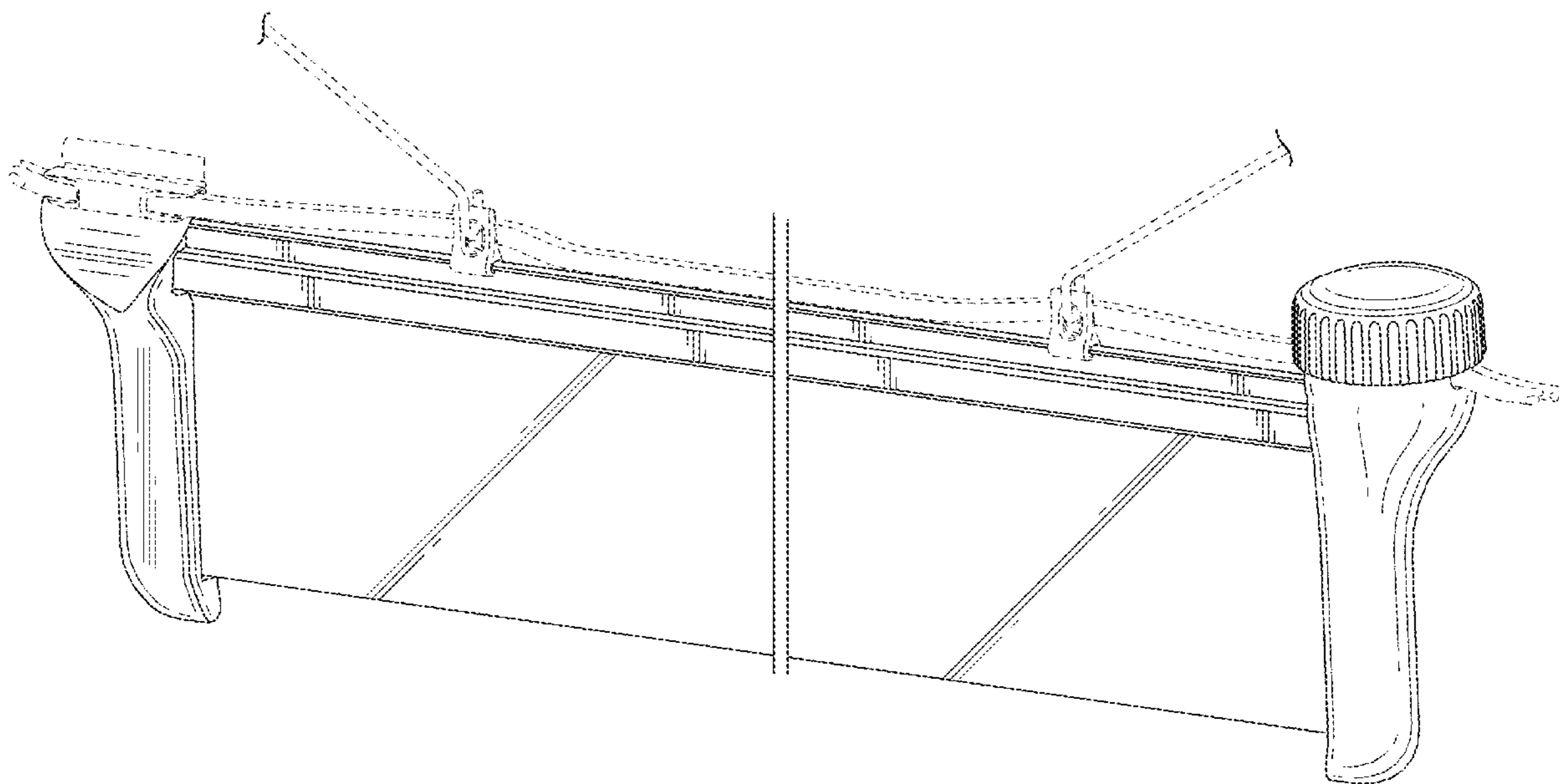

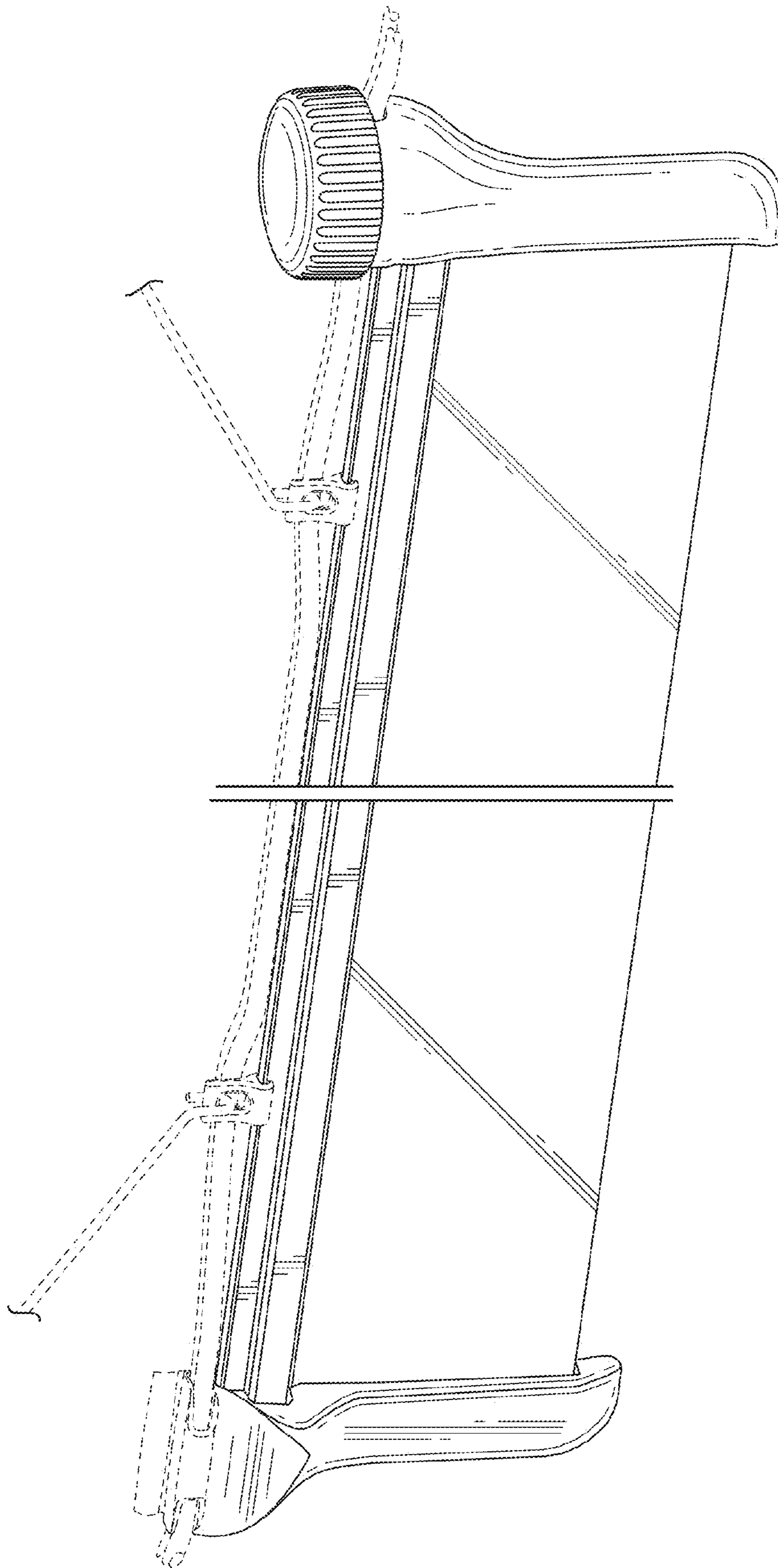

FIG. 1

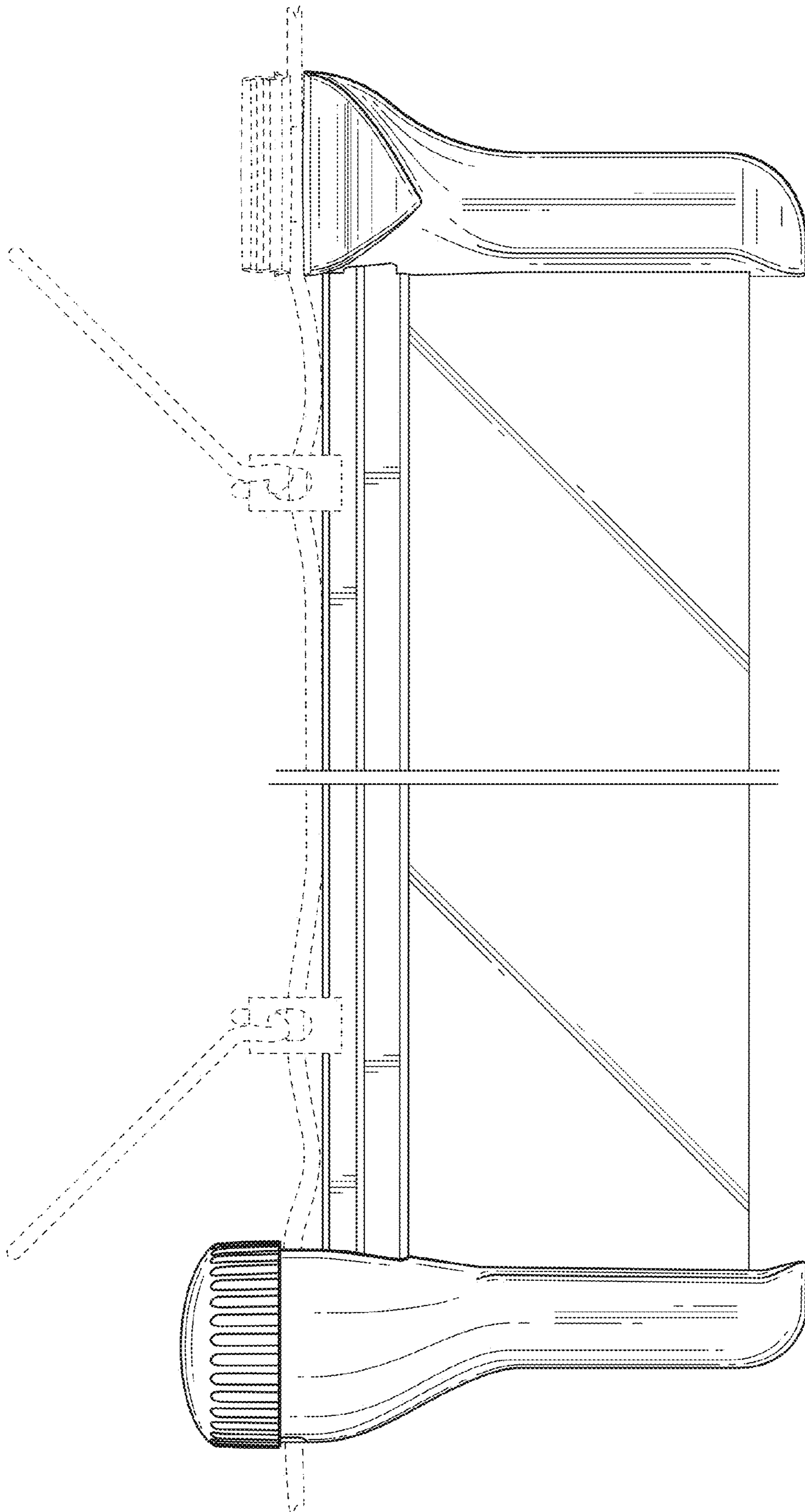

FIG. 2

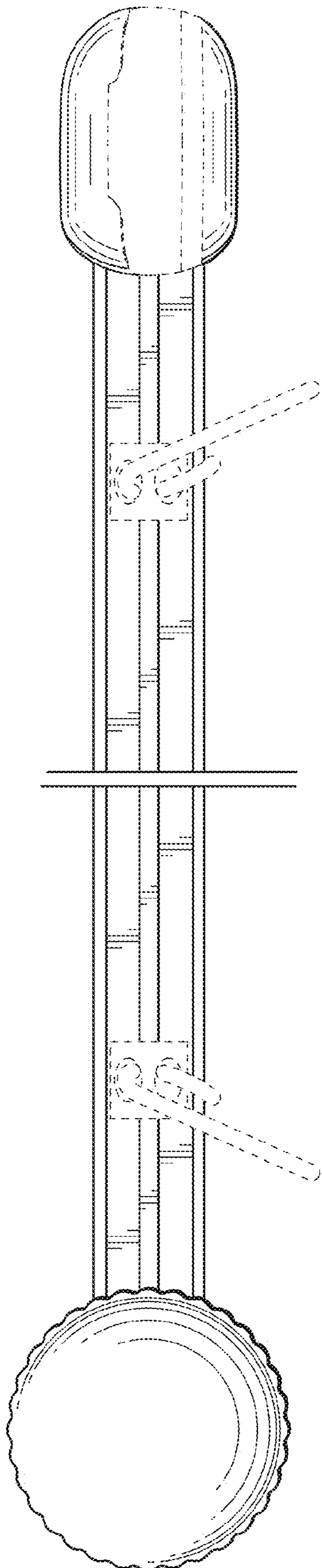

FIG. 3

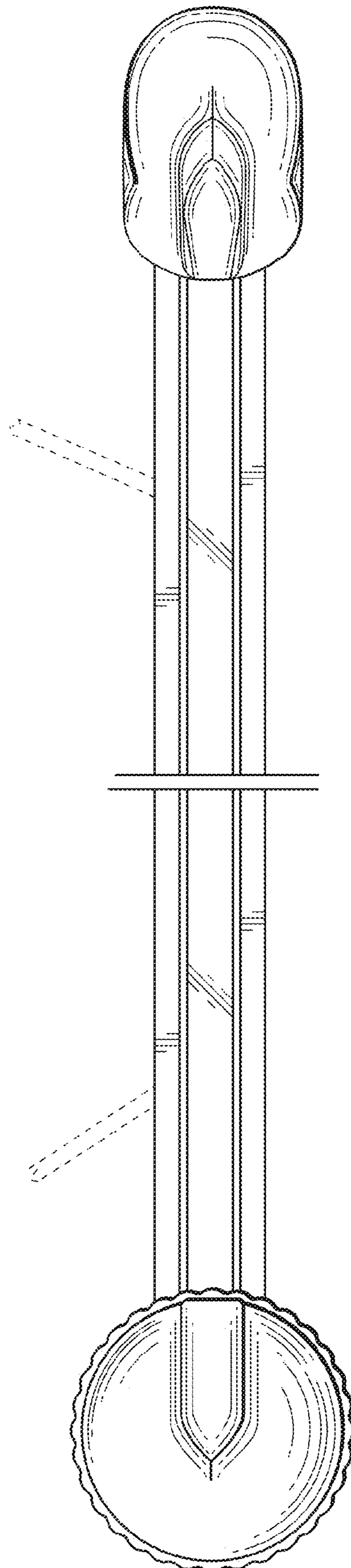

FIG. 4

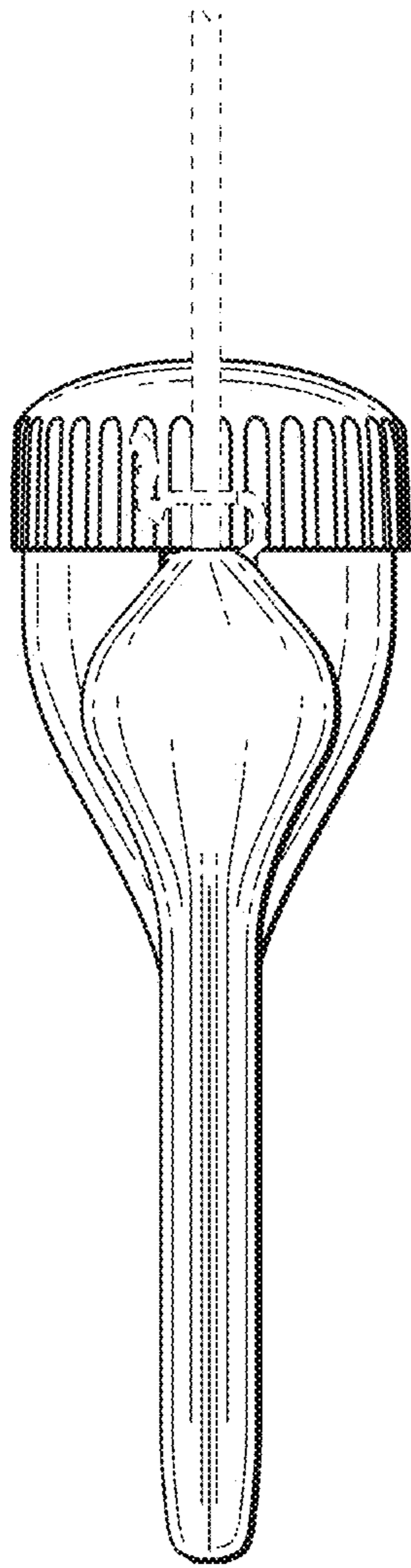

FIG. 5

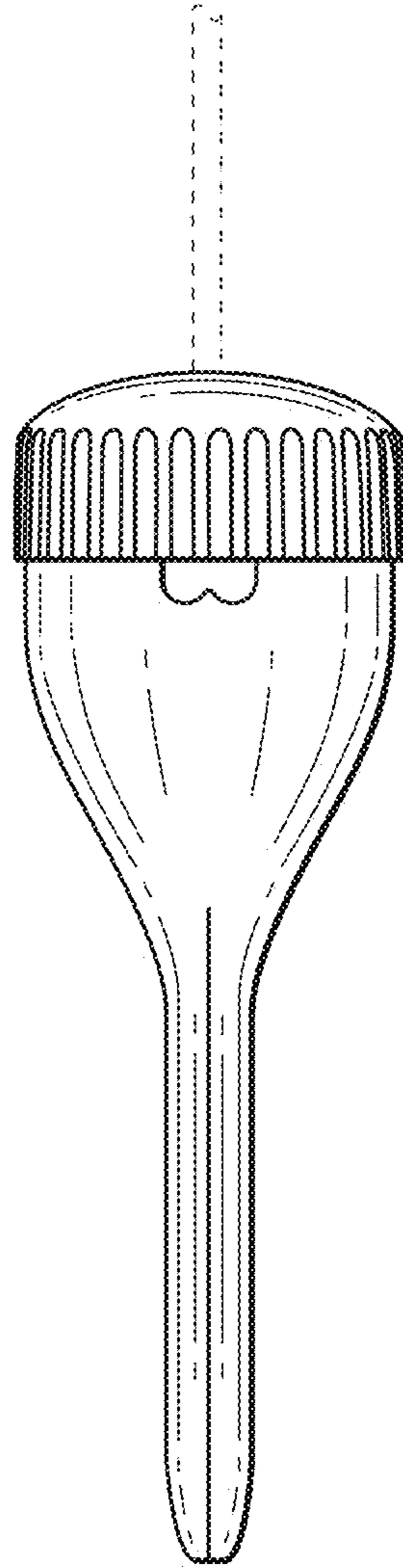

FIG. 6