



US00D930840S

(12) **United States Design Patent**
Misiaszek

(10) **Patent No.: US D930,840 S**

(45) **Date of Patent: ** Sep. 14, 2021**

(54) **HEARING ENHANCEMENT DEVICE**

(71) Applicant: **Stanley E. Misiaszek**, Ocala, FL (US)

(72) Inventor: **Stanley E. Misiaszek**, Ocala, FL (US)

(**) Term: **15 Years**

(21) Appl. No.: **29/709,813**

(22) Filed: **Oct. 17, 2019**

(51) **LOC (13) Cl. 24-99**

(52) **U.S. Cl.**
USPC **D24/175**

(58) **Field of Classification Search**
USPC D24/173-175, 186, 231; D14/205, 223,
D14/224, 225, 226, 249
CPC H04R 1/1008; A61F 11/008; A45D 44/12
See application file for complete search history.

(56) **References Cited**

U.S. PATENT DOCUMENTS

- 3,658,150 A * 4/1972 Turner A61F 11/008
181/136
- D244,467 S * 5/1977 Aquilino D24/175
- D286,873 S * 11/1986 Ikeda D14/205
- 4,771,859 A * 9/1988 Breland A61F 11/008
181/129
- D310,530 S * 9/1990 McGuire D14/205
- D322,070 S * 12/1991 Kitch D14/205
- D323,043 S * 1/1992 Lofton D14/205
- D376,362 S * 12/1996 Bozorgi-Ram D14/205

- 5,691,515 A * 11/1997 Landis A42B 3/30
181/129
- 5,965,850 A * 10/1999 Fraser A61F 11/008
181/129
- D541,257 S * 4/2007 Thursfield D14/205
- D667,813 S * 9/2012 Hickson A61F 11/008
D14/205

FOREIGN PATENT DOCUMENTS

GB 4022597 * 12/2011

* cited by examiner

Primary Examiner — Anhdao Doan

(74) *Attorney, Agent, or Firm* — The Rapacke Law Group P.A.

(57) **CLAIM**

The ornamental design for a hearing enhancement device, as shown and described.

DESCRIPTION

FIG. 1 is a perspective view of a hearing enhancement device, showing the new design;
 FIG. 2 is a front elevational view thereof;
 FIG. 3 is a rear elevational view thereof;
 FIG. 4 is a left side elevational view thereof;
 FIG. 5 is a right side elevational view thereof;
 FIG. 6 is a top plan view thereof; and,
 FIG. 7 is a bottom plan view thereof.

1 Claim, 5 Drawing Sheets

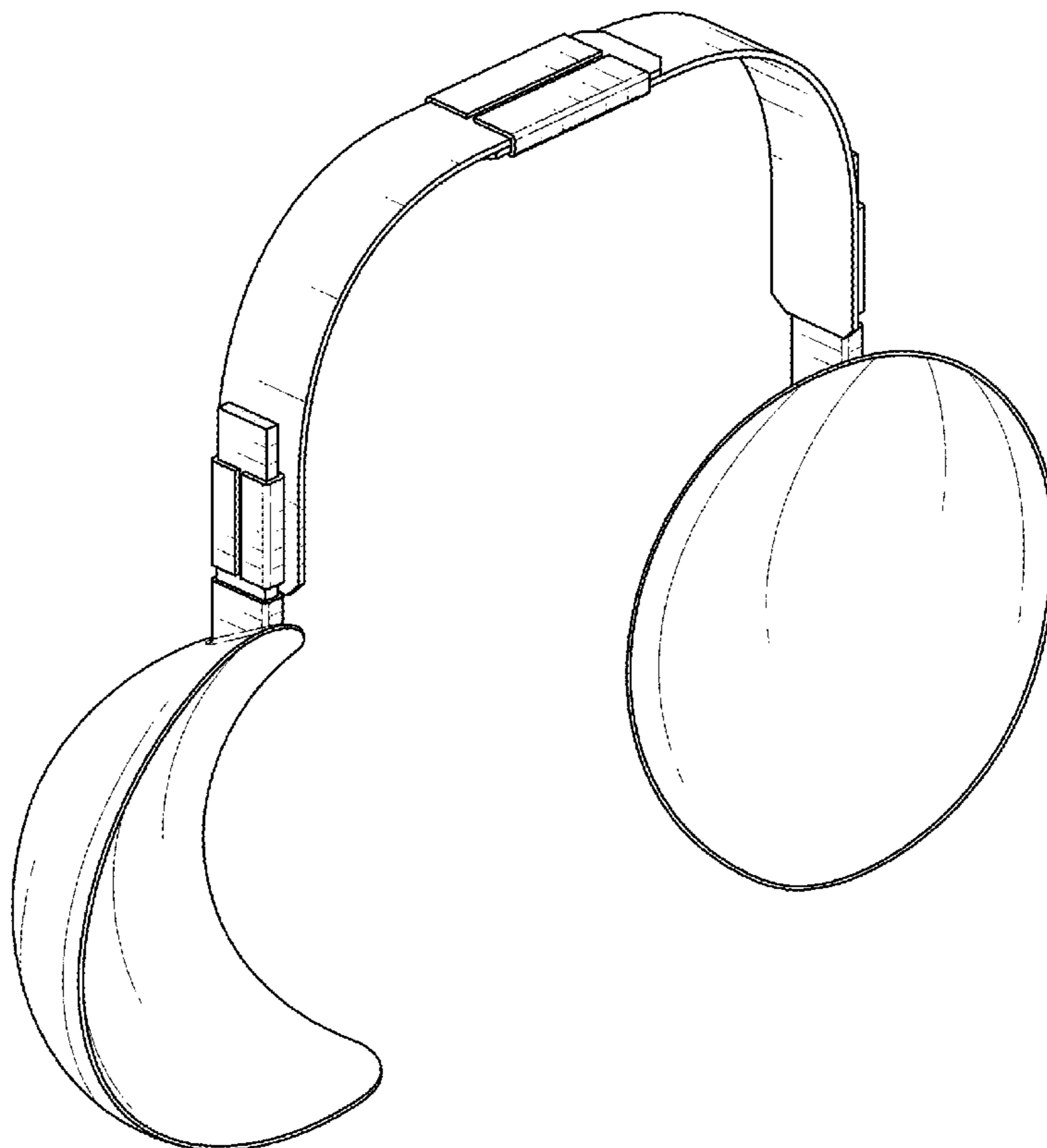

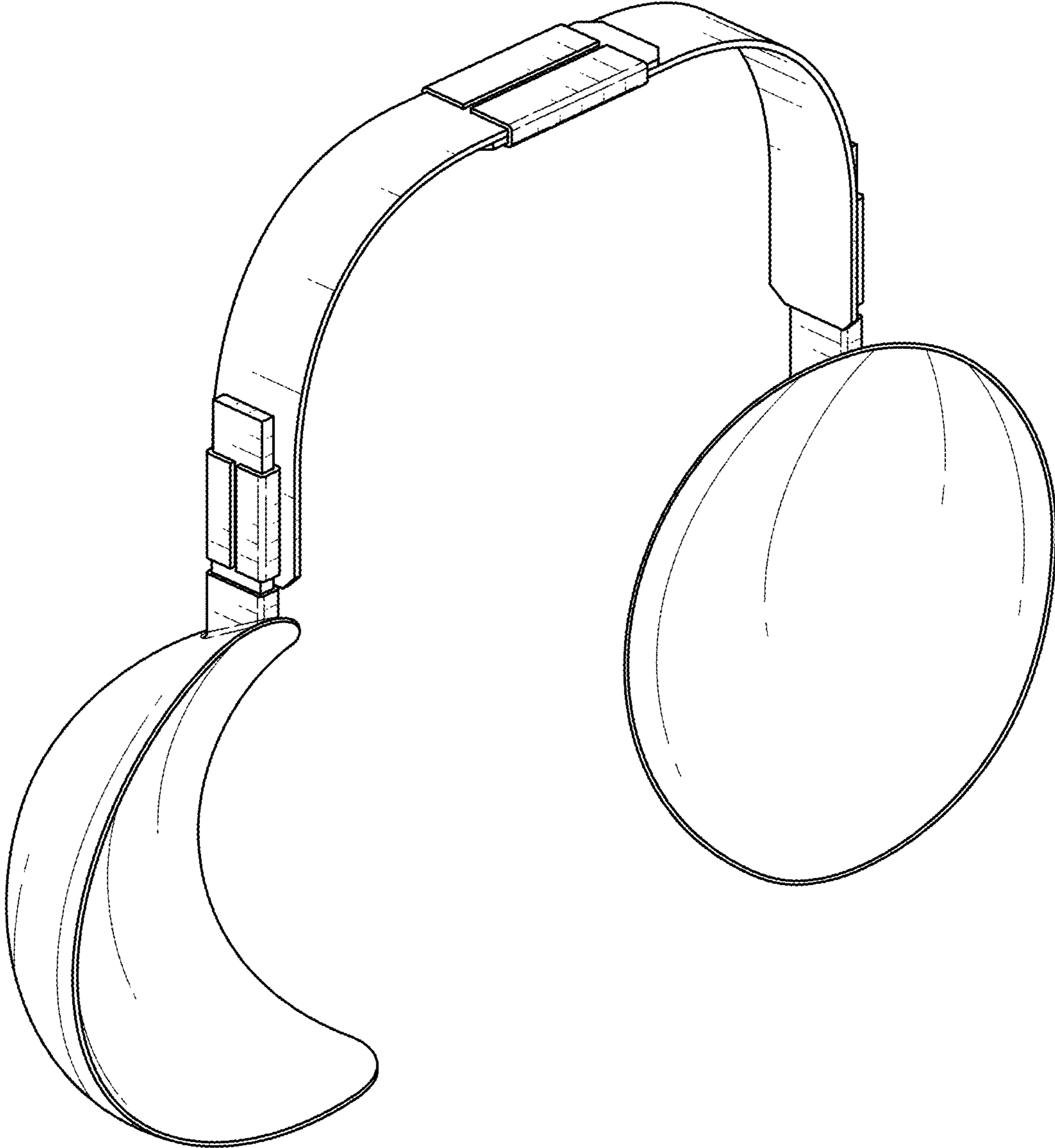

FIG. 1

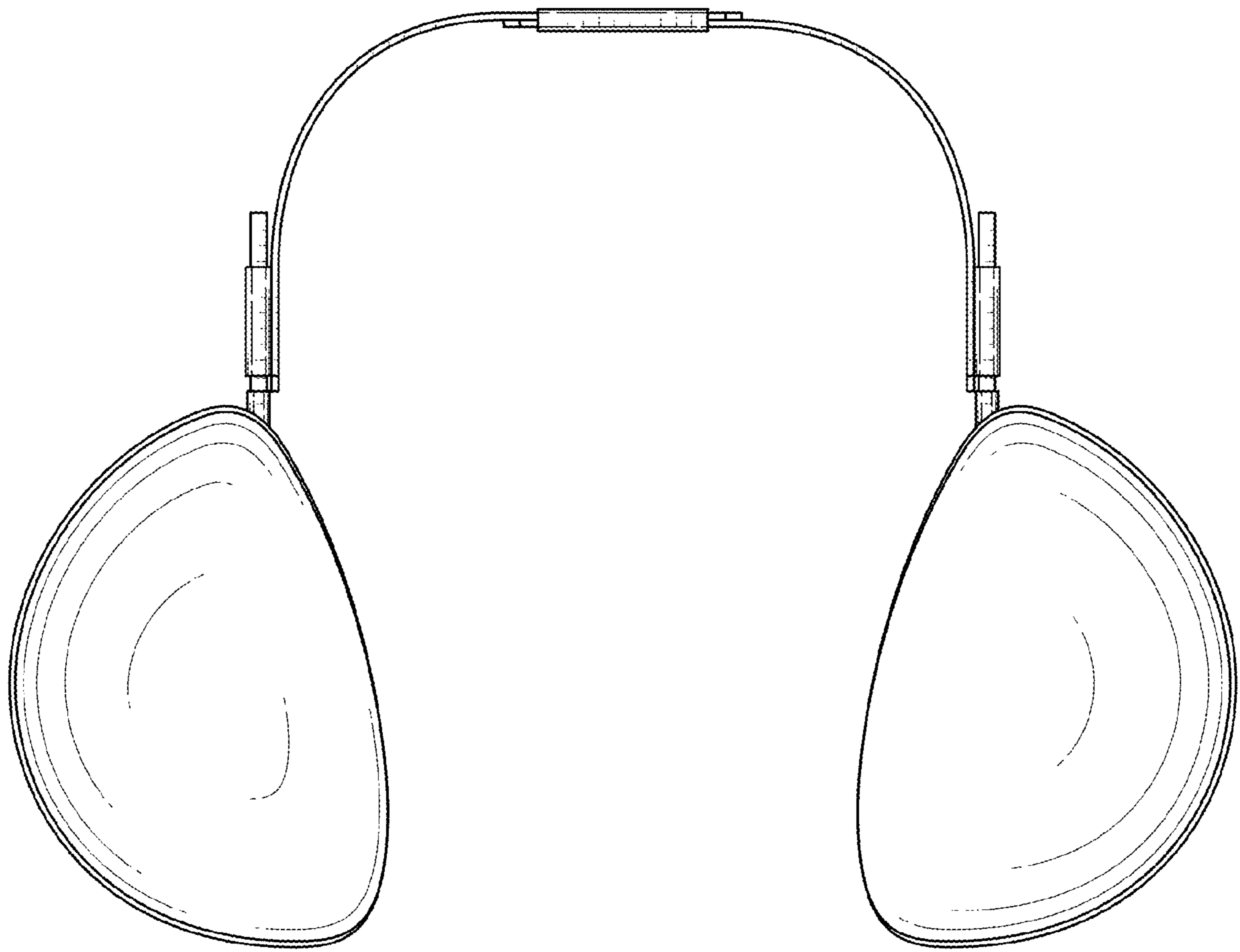

FIG. 2

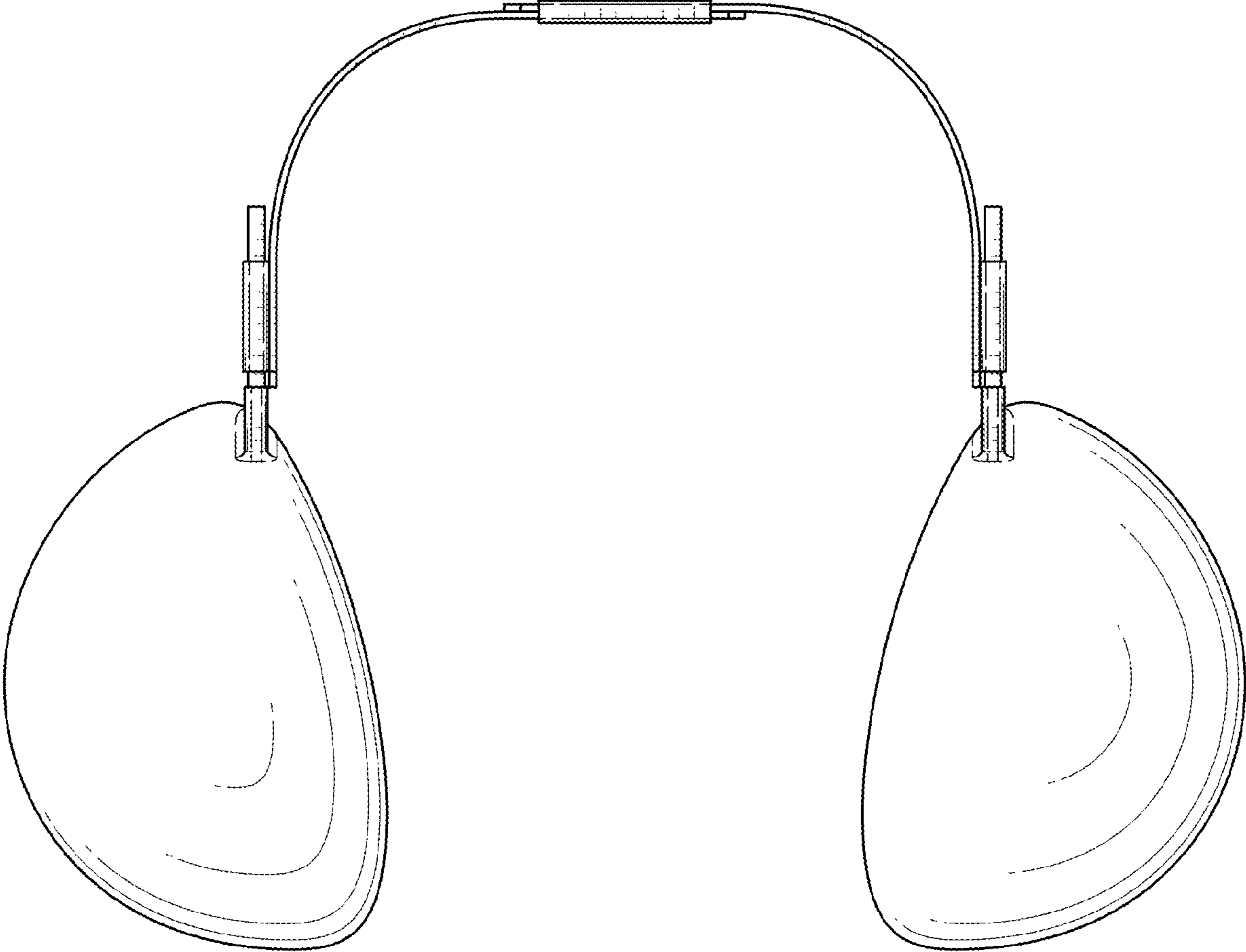

FIG. 3

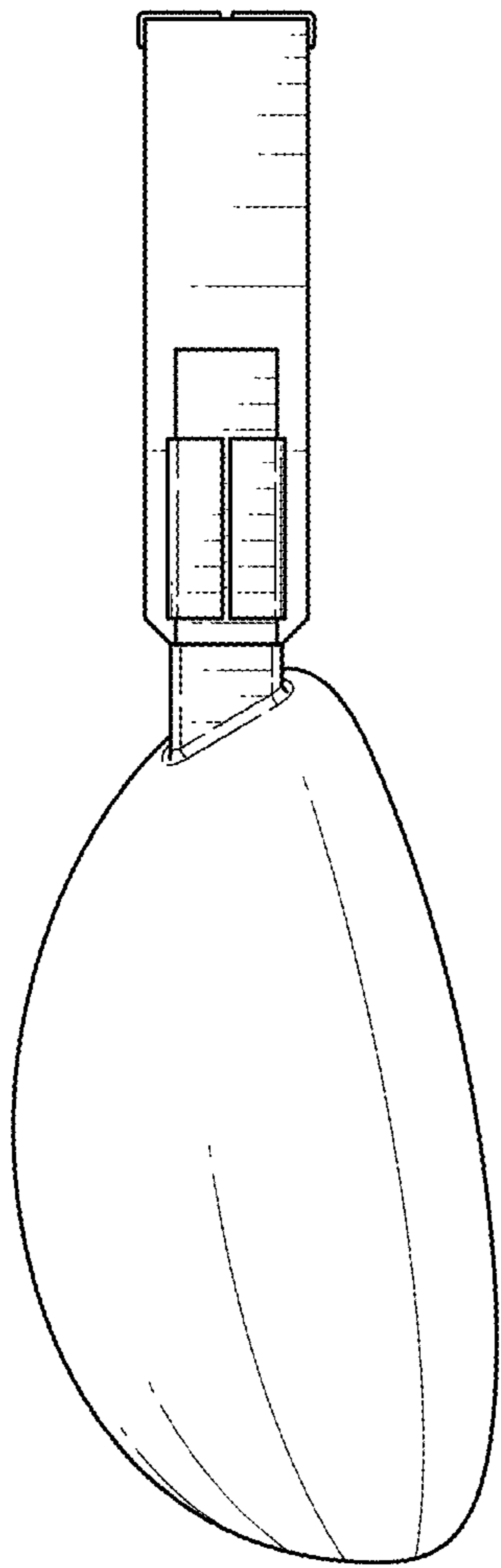

FIG. 4

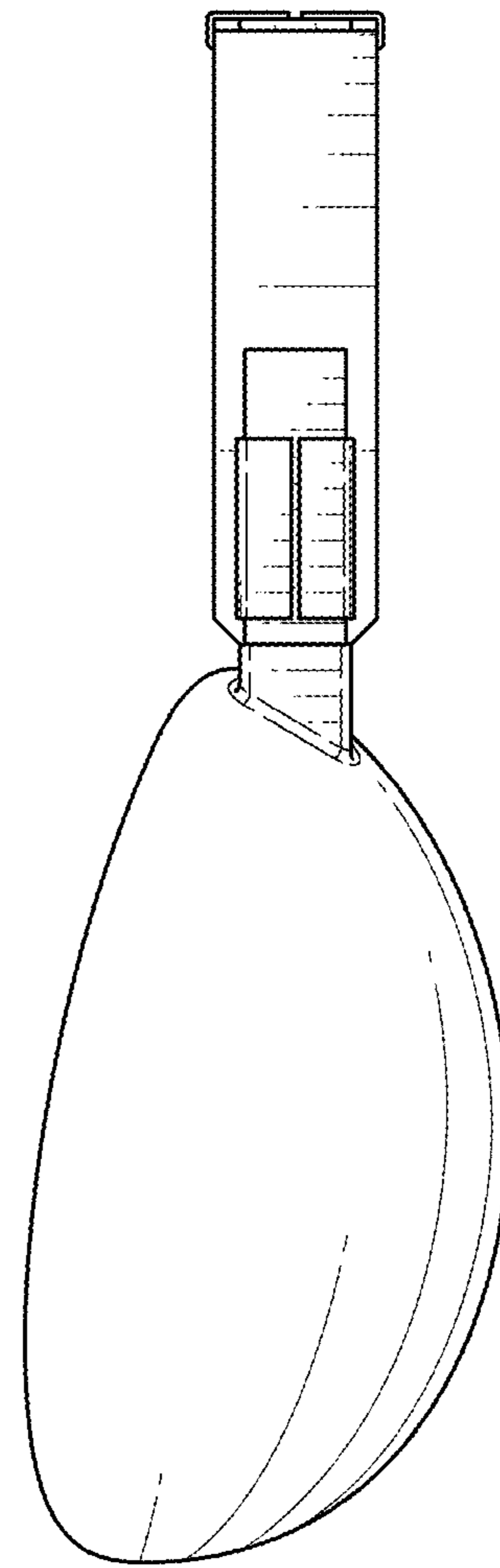

FIG. 5

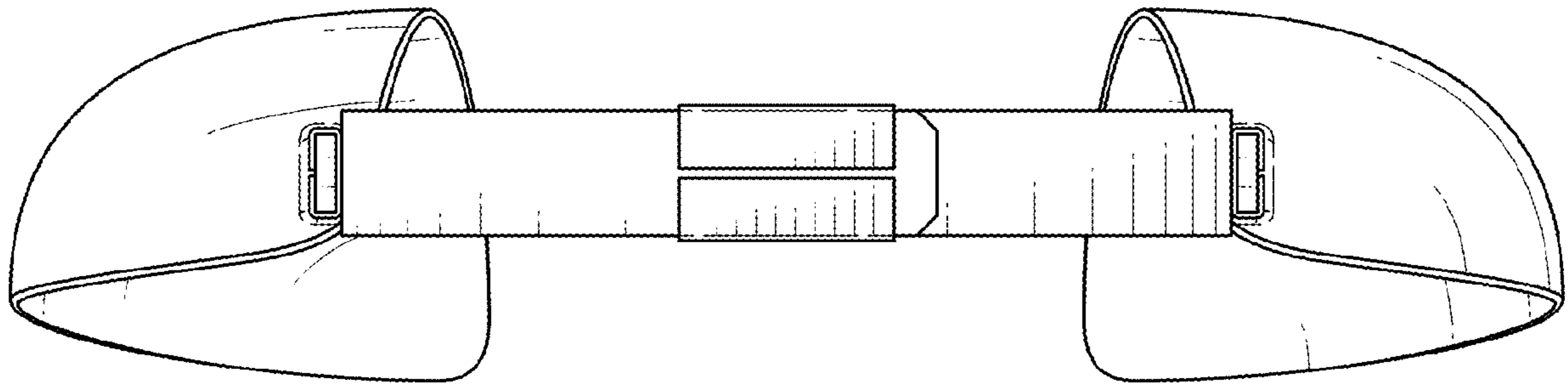

FIG. 6

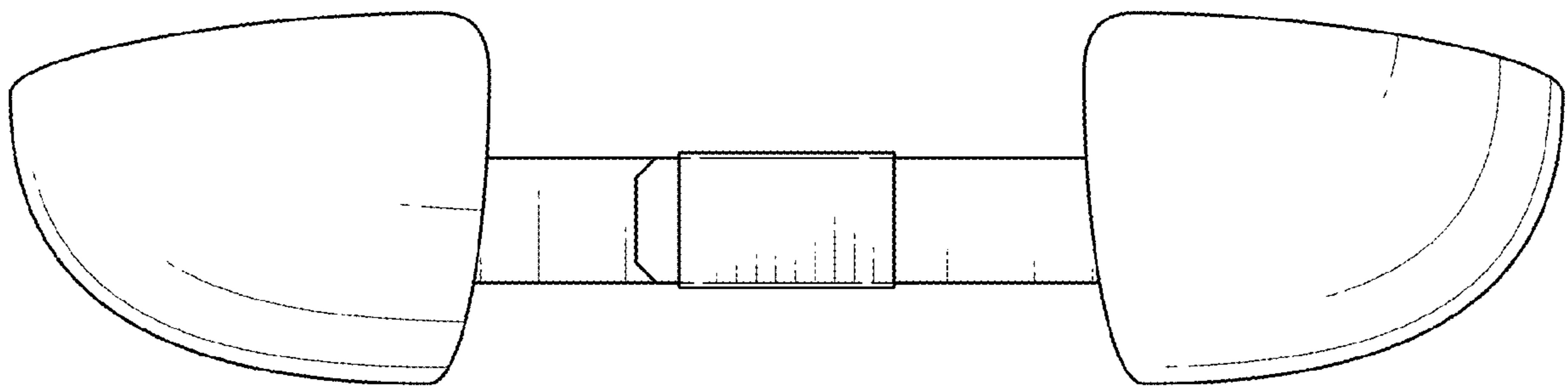

FIG. 7