



US00D930817S

(12) **United States Design Patent** (10) **Patent No.:** **US D930,817 S**
Wu (45) **Date of Patent:** **** Sep. 14, 2021**

(54) **OXYGEN PUMP**
(71) Applicant: **SHENZHEN BSV SOLAR ENERGY CO., LTD**, Shenzhen (CN)
(72) Inventor: **Huiqiang Wu**, Shenzhen (CN)
(**) Term: **15 Years**
(21) Appl. No.: **29/713,741**
(22) Filed: **Nov. 18, 2019**

D855,251 S * 7/2019 Qiu D27/162
D861,973 S * 10/2019 Qiu D27/101
D871,663 S * 12/2019 Lord D27/101
D888,934 S * 6/2020 Nguyen D24/110
D893,023 S * 8/2020 Hogenauer D24/127
D908,952 S * 1/2021 Guo D27/101
D912,641 S * 3/2021 Dai D14/158
D912,890 S * 3/2021 Liu D27/162

(30) **Foreign Application Priority Data**

Aug. 19, 2019 (EM) 006740148

(51) **LOC (13) Cl.** **29-02**

(52) **U.S. Cl.**
USPC **D24/110**

(58) **Field of Classification Search**
USPC D24/107, 108, 110, 110.1–110.5, 127,
D24/164; D29/108; D27/163–167
CPC A61M 15/0085; A61M 15/0005; A61M
11/005; A61M 11/00; A61M 11/02;
A61M 11/04; A61M 5/087; A61M
5/0871; A61M 5/091; A61M 5/097;
A61M 15/00; A61M 15/0065; A61M
15/0091; A61M 15/0021; A61M 15/0026;
A61M 15/008; A61M 15/007; A63B
23/18

See application file for complete search history.

(56) **References Cited**

U.S. PATENT DOCUMENTS

D532,927 S * 11/2006 Sann D27/101
D744,109 S * 11/2015 Yoneta D24/186
D744,110 S * 11/2015 Kubo D24/186
D776,270 S * 1/2017 Wilcox D24/127
D779,719 S * 2/2017 Qiu D27/101
D804,334 S * 12/2017 Becker D10/70
D837,446 S * 1/2019 Durand D27/101

OTHER PUBLICATIONS

Sunbell Air Pump Solar Kit Solar, posted at amazon.com, earliest date reviewed on Oct. 29, 2019, [online], acquired on Apr. 10, 2021, Available on internet. url:https://www.amazon.com/Sunbell-Powered-Oxygenator-Aerator-Upgrade/dp/B07WHNW411/ref=cm_cr_arp_d_product_top?ie=UTF8 (Year: 2019) (Year: 2019).*

* cited by examiner

Primary Examiner — Sheryl Lane
Assistant Examiner — Aula Soroush

(57) **CLAIM**

The ornamental design for a oxygen pump, as shown and described.

DESCRIPTION

FIG. 1 is a first perspective view of a oxygen pump showing my new design;
FIG. 2 is a second perspective view thereof;
FIG. 3 is a front view thereof;
FIG. 4 is a back view thereof;
FIG. 5 is a left side view thereof;
FIG. 6 is a right side view thereof;
FIG. 7 is a top view thereof; and,
FIG. 8 is a bottom view thereof.

The broken lines shown in the drawings depict portions of the oxygen pump in which the design is embodied that form no part of the claimed design.

1 Claim, 8 Drawing Sheets

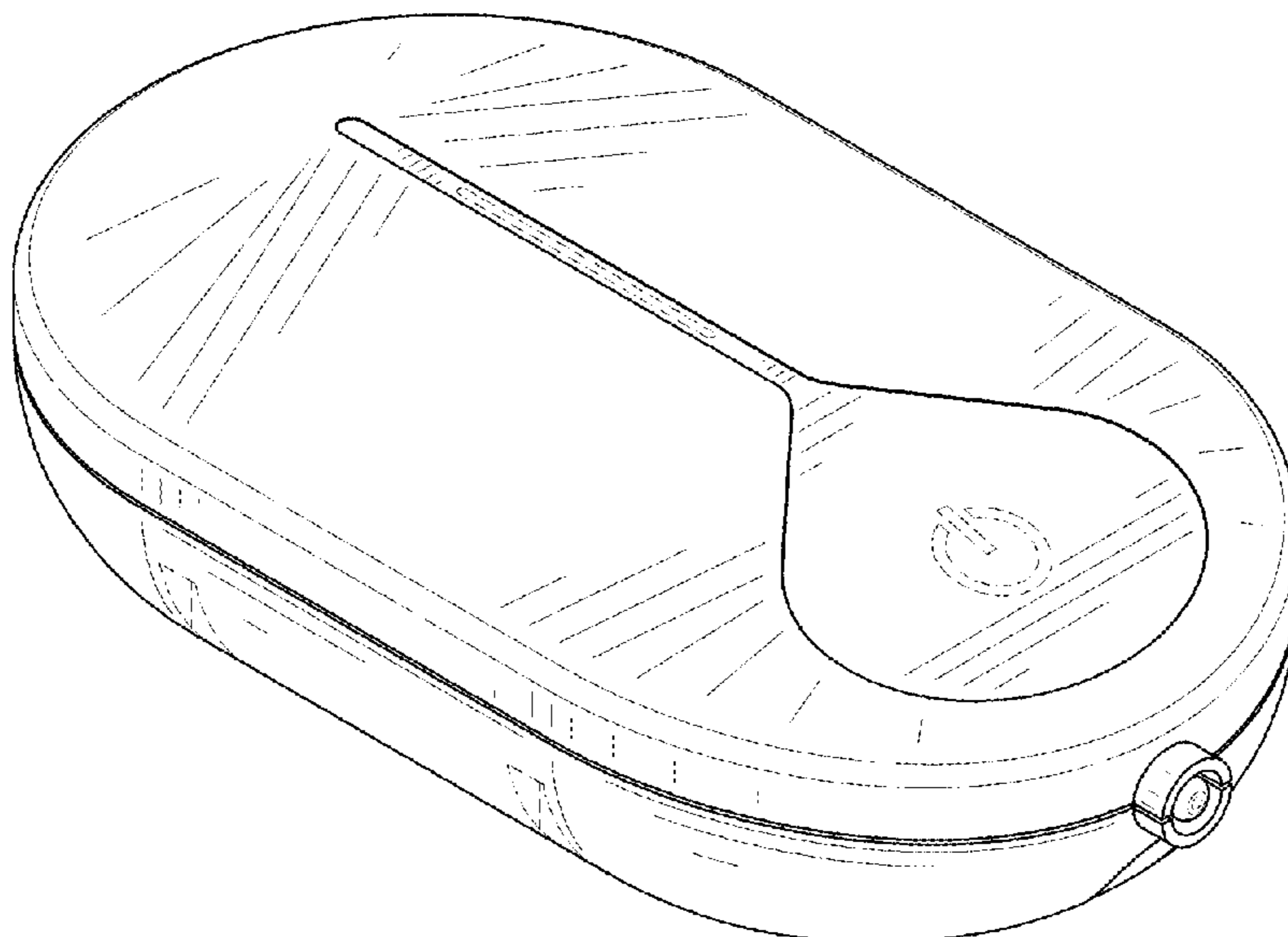

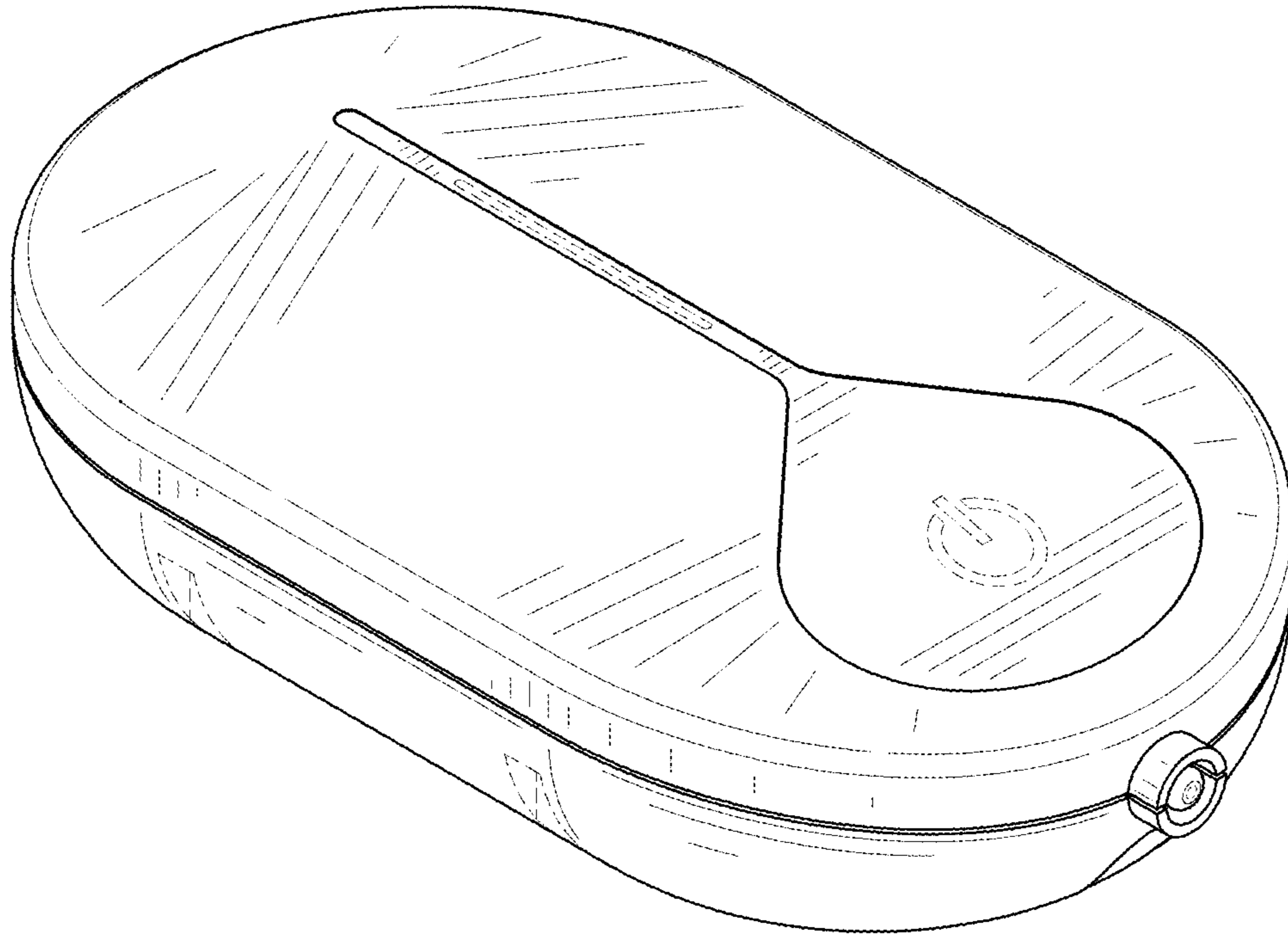

FIG. 1

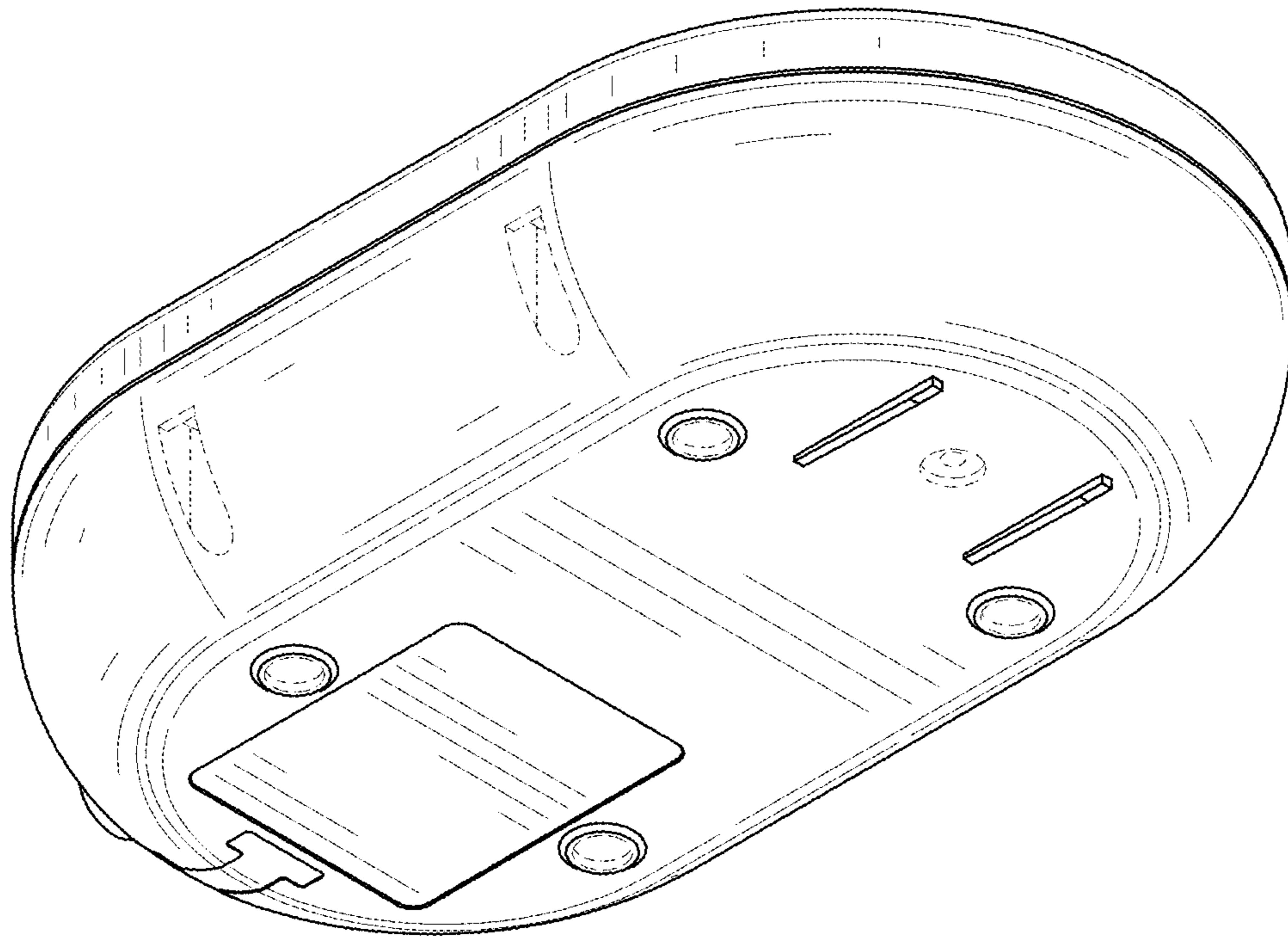

FIG. 2

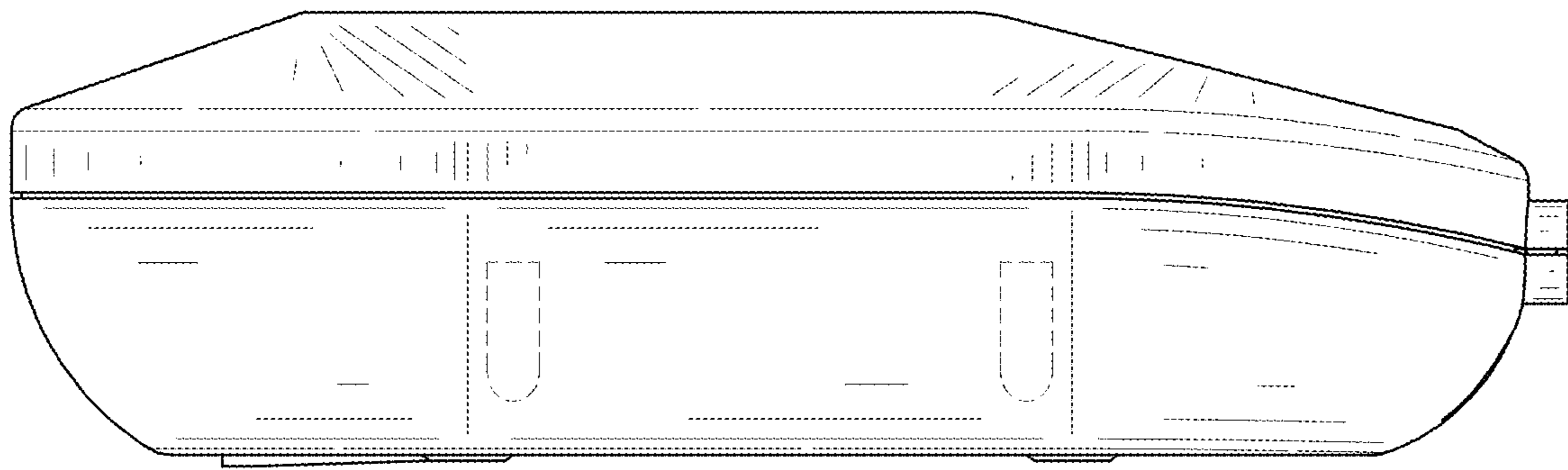

FIG. 3

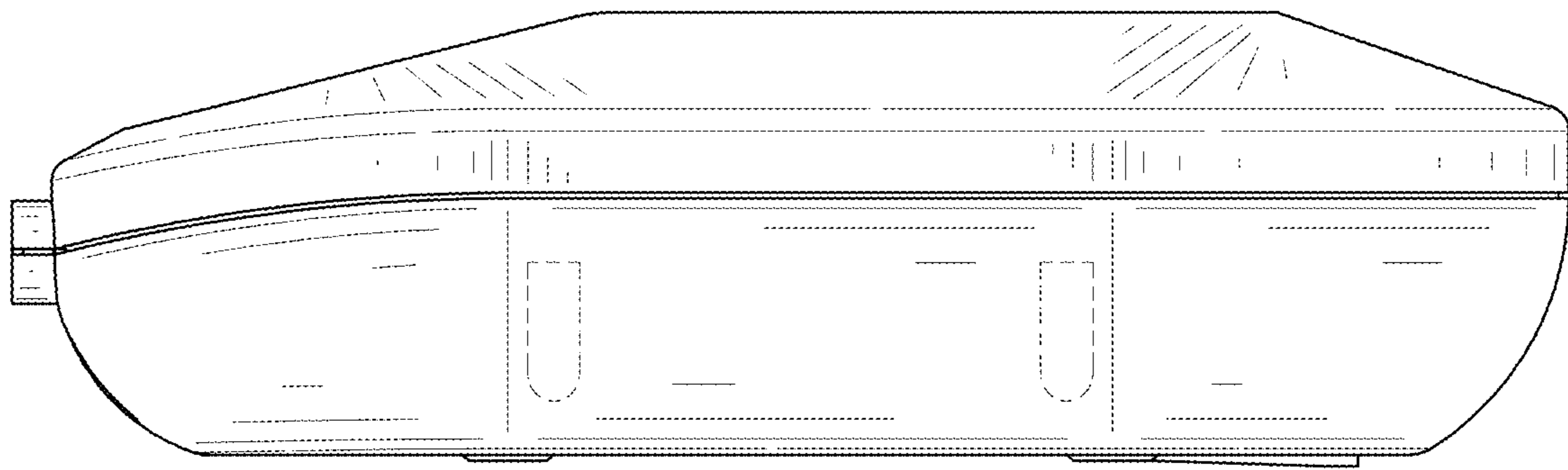

FIG. 4

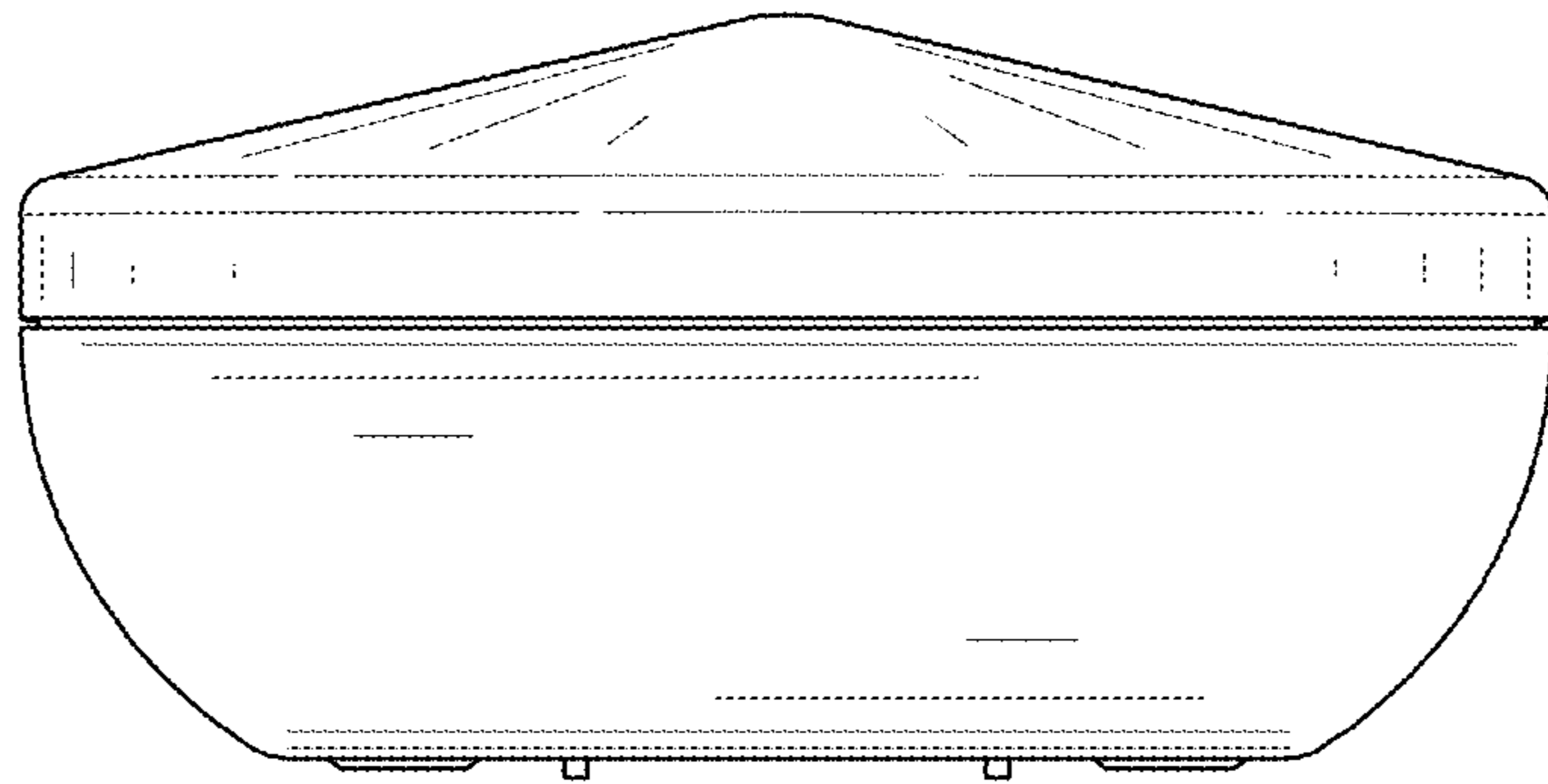

FIG. 5

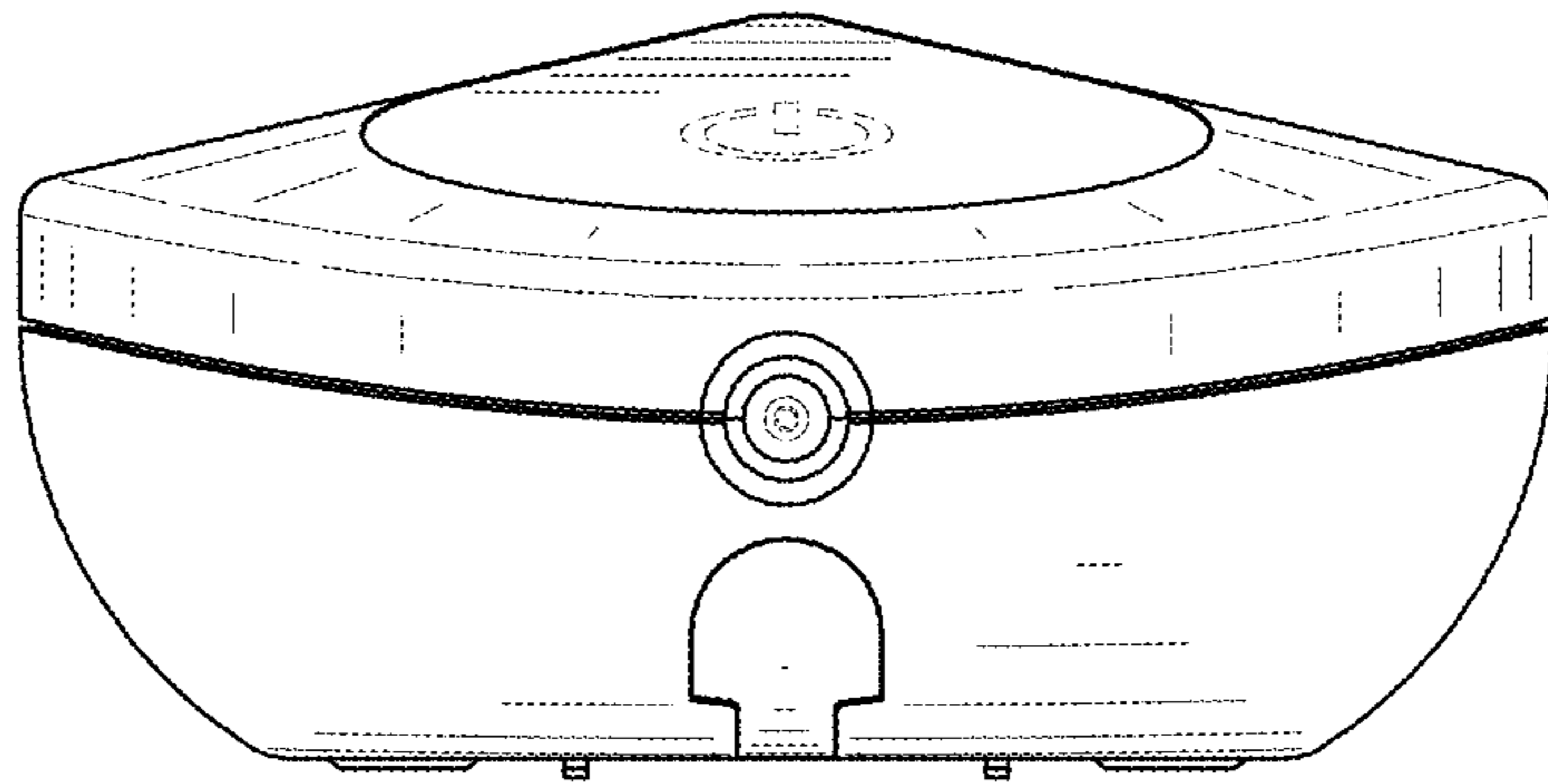

FIG. 6

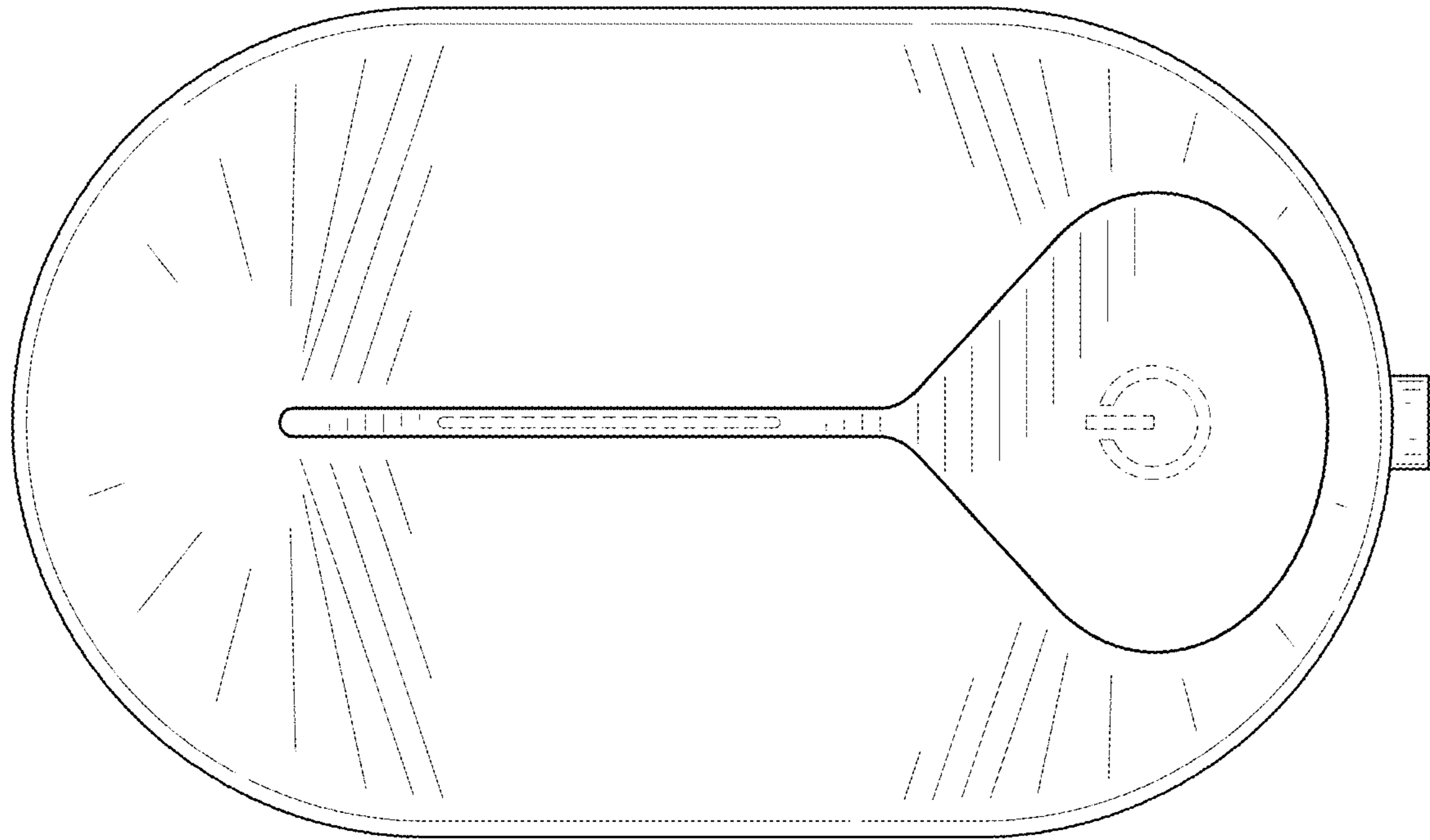

FIG. 7

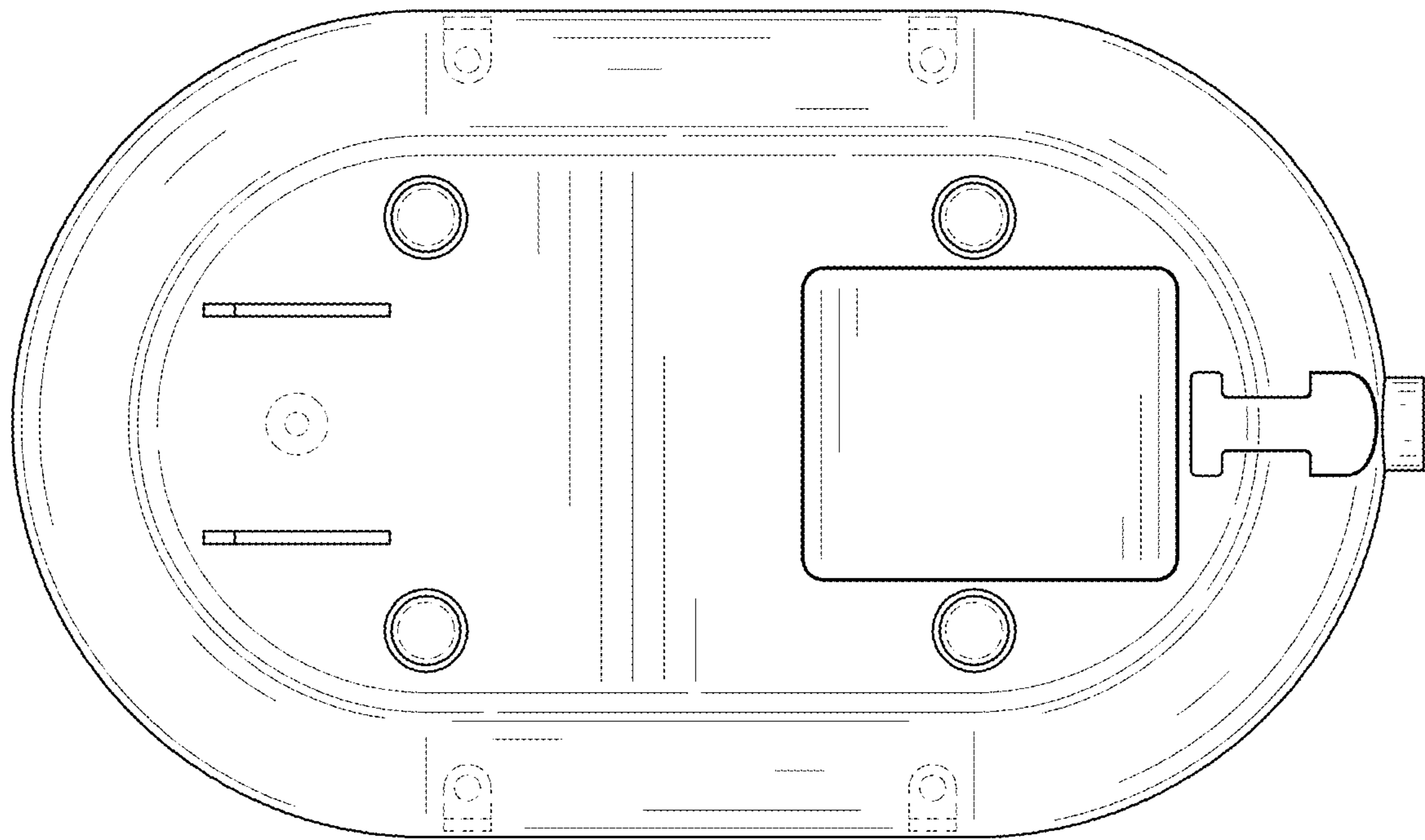

FIG. 8