



US00D930814S

(12) **United States Design Patent** (10) **Patent No.:** **US D930,814 S**
Dorsey (45) **Date of Patent:** **** Sep. 14, 2021**

- (54) **FIREPLACE SURROUND**
- (71) Applicant: **Chad Dorsey Design, LLC**, Dallas, TX (US)
- (72) Inventor: **Chad Dorsey**, Dallas, TX (US)
- (73) Assignee: **Chad Dorsey Design, LLC**, Dallas, TX (US)
- (**) Term: **15 Years**
- (21) Appl. No.: **29/795,274**
- (22) Filed: **Jun. 17, 2021**

Related U.S. Application Data

- (62) Division of application No. 29/729,055, filed on Mar. 24, 2020.
- (51) **LOC (13) Cl.** **23-03**
- (52) **U.S. Cl.**
USPC **D23/404**
- (58) **Field of Classification Search**
USPC D23/403, 404, 405, 406, 407, 408, 409, D23/415, 416; D25/60
CPC F24B 1/18; F24B 1/1804; F24B 1/1808; F24B 1/195; F24B 1/197; F24B 1/198; F24C 3/006
See application file for complete search history.

(56) **References Cited**

U.S. PATENT DOCUMENTS

- 1,479 A * 1/1840 Crosley F24B 1/18 126/500
- 3,826 A * 11/1844 Gilbert F24B 1/18 126/500
- 269,772 A * 12/1882 Woolfenden F24B 1/198 52/36.3
- D90,908 S * 10/1933 Beauchamp D6/664
- D108,009 S * 1/1938 Baum D23/404
- D108,148 S * 1/1938 Baum D23/404

- D110,383 S * 7/1938 Baum D25/60
 - 2,154,939 A * 4/1939 Howe F24B 1/198 126/531
 - D119,873 S * 4/1940 Wright D6/673
 - 2,210,580 A * 8/1940 Gersten F24B 1/195 446/480
 - D147,081 S * 7/1947 Prebis D23/404
 - D178,714 S * 9/1956 Woodward D25/60
 - D253,143 S * 10/1979 Shaw D25/60
 - D300,356 S 3/1989 Becker
 - D300,461 S 3/1989 Becker
 - D300,943 S 5/1989 Heger
- (Continued)

OTHER PUBLICATIONS

“Stone Mountain Castings and Design photo”, Jul. 12, 2017, Facebook, site visited Jun. 28, 2021: [https://www.facebook.com/StoneMountainCastingsAndDesign/photos/a.339729919425308/1474467639284858/\(Year: 2017\).*](https://www.facebook.com/StoneMountainCastingsAndDesign/photos/a.339729919425308/1474467639284858/(Year: 2017).*)
(Continued)

Primary Examiner — Jack Reickel
Assistant Examiner — Bobby W Jones, II
(74) *Attorney, Agent, or Firm* — Hemingway & Hansen LLP; D. Scott Hemingway; Elizabeth P. Hartman

(57) **CLAIM**

The ornamental design for a fireplace surround, as shown and described.

DESCRIPTION

FIG. 1 is a front perspective view of a fireplace surround of the present application;
FIG. 2 is a front elevation view of FIG. 1;
FIG. 3 is a rear elevation view of FIG. 1;
FIG. 4 is a top view of FIG. 1;
FIG. 5 is a bottom view of FIG. 1;
FIG. 6 is a left side view of FIG. 1; and,
FIG. 7 is a right side view of FIG. 1.

1 Claim, 3 Drawing Sheets

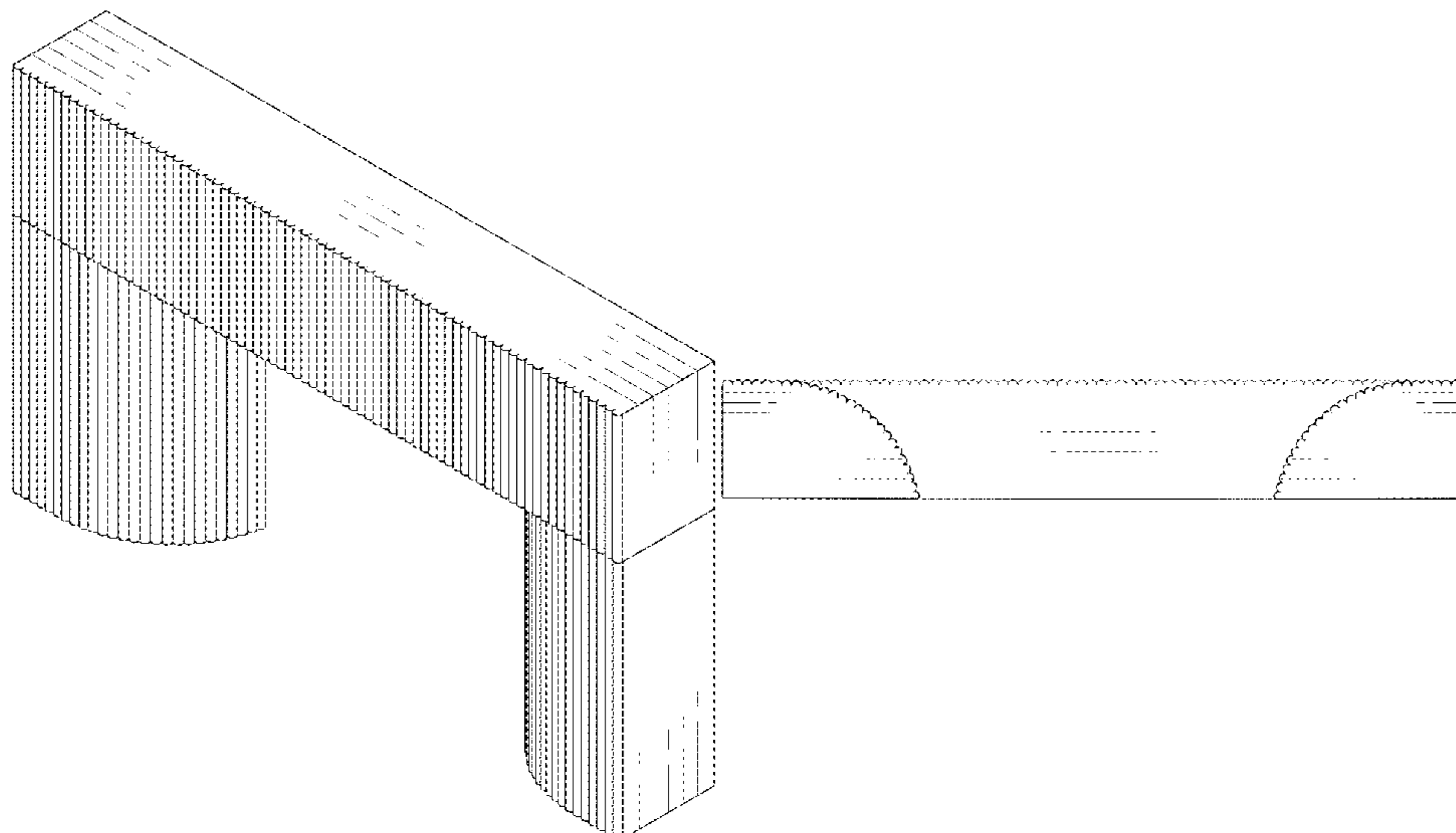

(56)

References Cited

U.S. PATENT DOCUMENTS

D300,944 S 5/1989 Heger
 4,945,692 A * 8/1990 Gallier E04F 19/005
 52/315
 D318,914 S 8/1991 Becker
 D407,577 S * 4/1999 Dorst D6/658
 6,029,731 A * 2/2000 Brazell F24B 1/198
 160/352
 D516,196 S 2/2006 Johnson
 D519,202 S * 4/2006 Lyons D23/404
 D526,403 S 8/2006 Hills
 D529,599 S 10/2006 Hills
 D532,898 S 11/2006 Hills
 D532,899 S 11/2006 Hills
 D532,900 S 11/2006 Hills
 D534,271 S 12/2006 Hills
 D535,382 S 1/2007 Hills
 D539,412 S 3/2007 Hills
 D688,365 S * 8/2013 Hadi D23/404
 D828,537 S * 9/2018 Chen D23/404
 D828,538 S * 9/2018 Chen D23/404
 D828,539 S * 9/2018 Chen D23/404

2005/0050805 A1* 3/2005 Lyons E04F 19/00
 52/36.3
 2005/0076902 A1* 4/2005 Lyons F24B 1/18
 126/500
 2005/0198914 A1* 9/2005 Lyons F24B 1/198
 52/36.3
 2009/0038606 A1* 2/2009 Weinberger F24B 1/195
 126/552
 2010/0307477 A1* 12/2010 Gallo F24B 1/18
 126/500

OTHER PUBLICATIONS

“Fontine Series Mantle Model FS00100”, Mar. 21, 2019, Home Depot, site visited Jun. 28, 2021: <https://www.homedepot.com/p/Fontine-Series-74-in-x-56-in-Mantel-FS00100/306173457> (Year: 2019).*

“Chad Dorsey Debuts Strike”, Mar. 30, 2020, California Home Design, site visited May 17, 2021: <https://www.californiahomedesign.com/trending/2020/03/30/chad-dorsey-debuts-strike-a-collection-of-fireplaces/> (Year: 2020).*

* cited by examiner

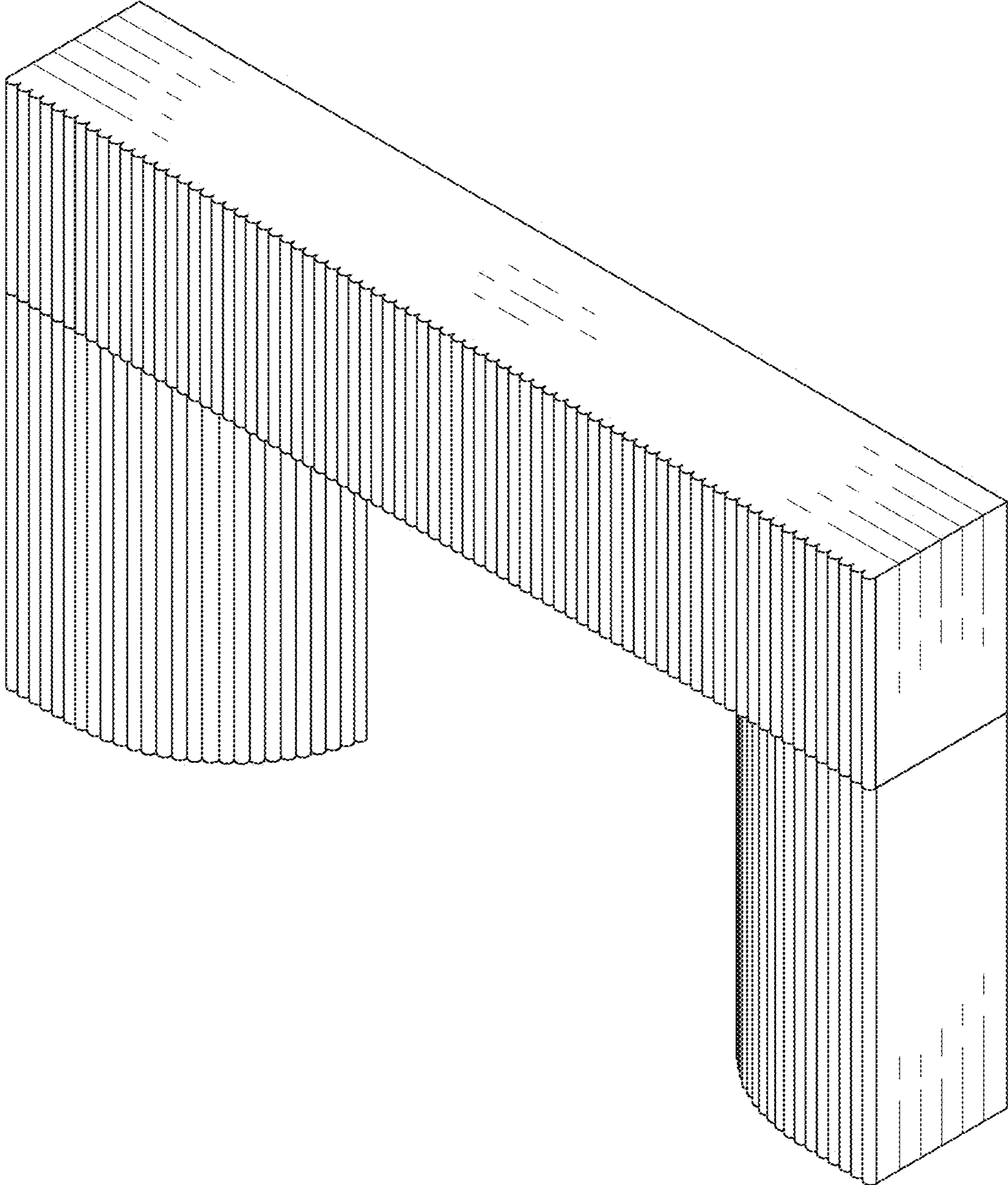

FIG. 1

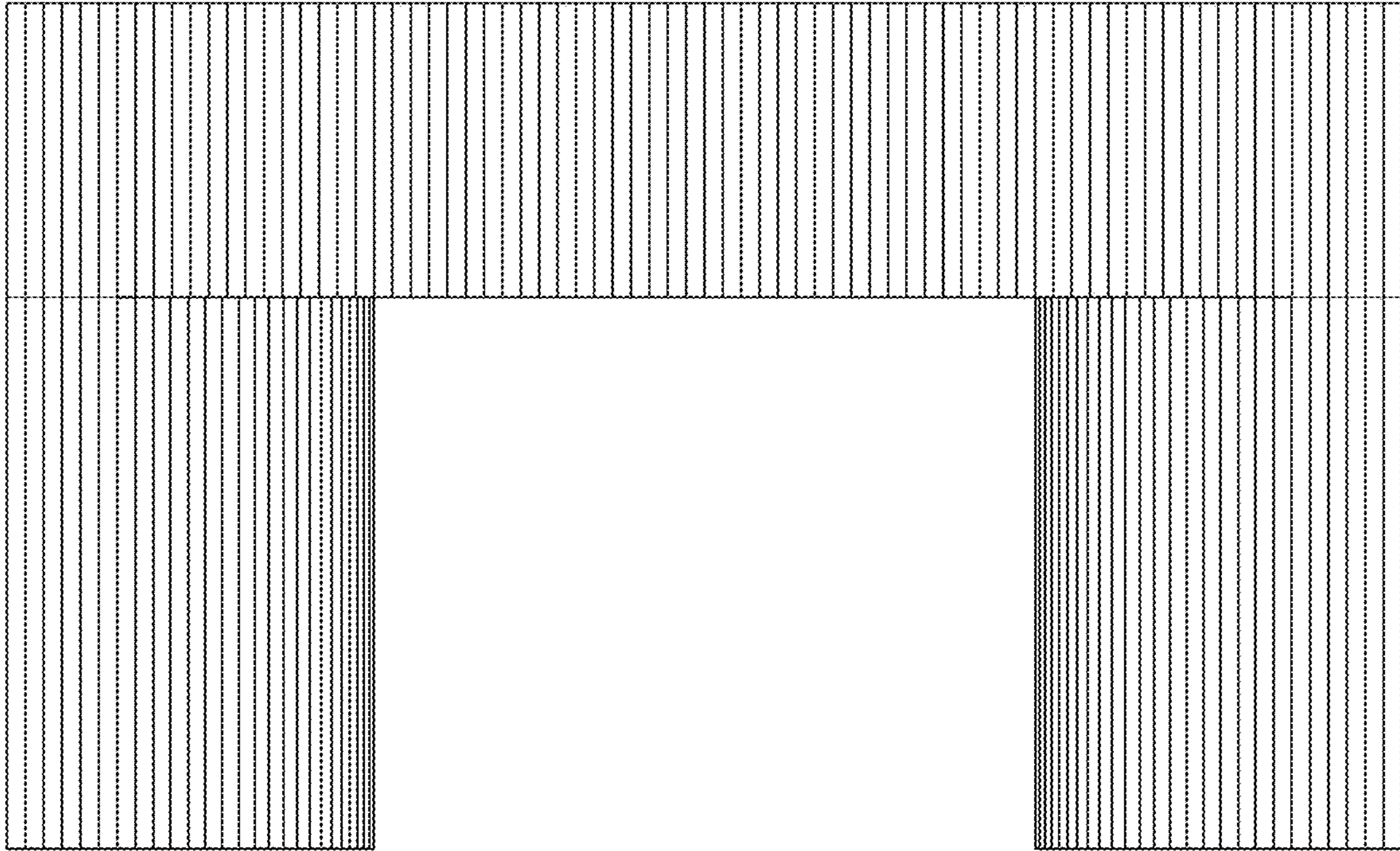

FIG. 2

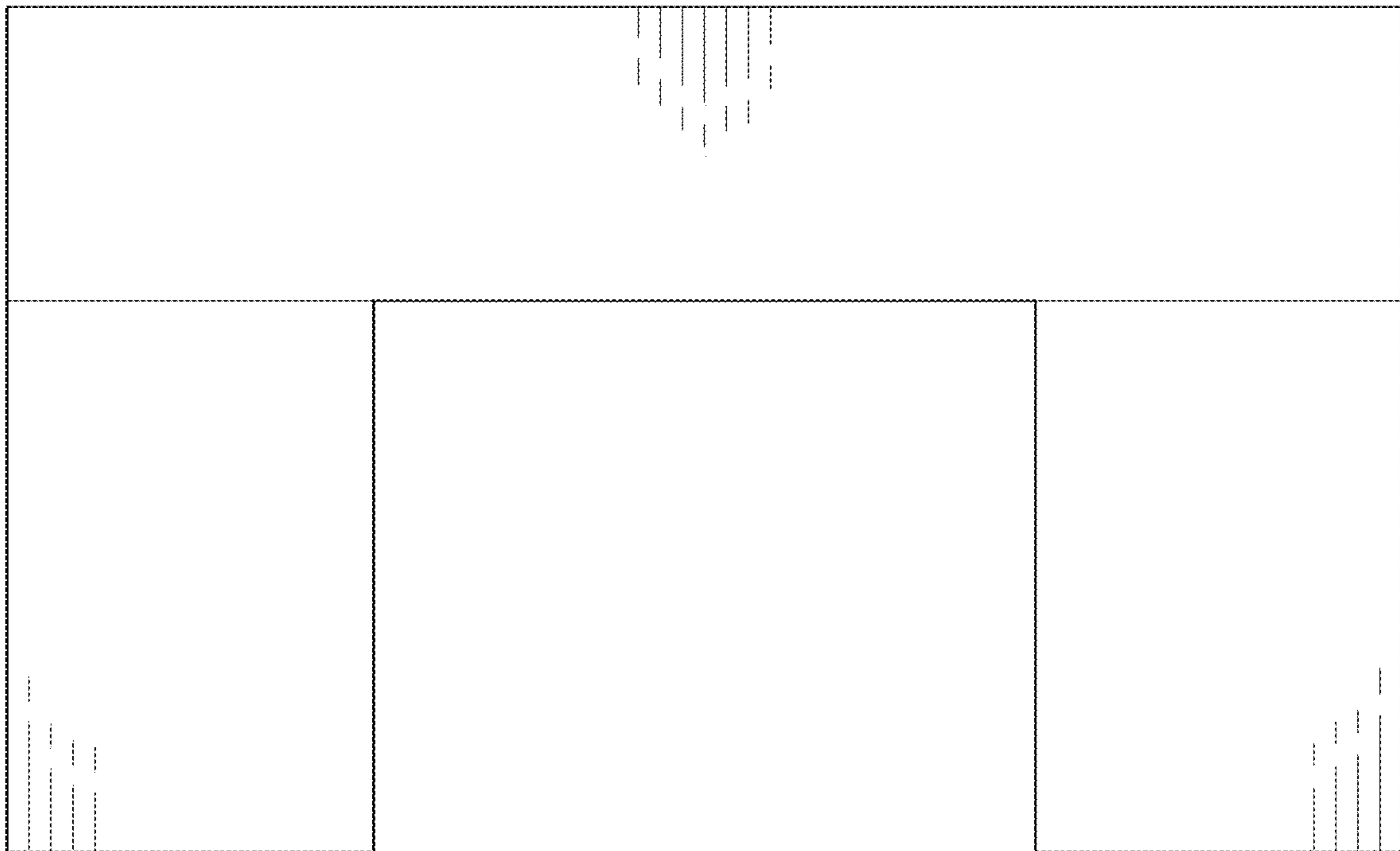

FIG. 3

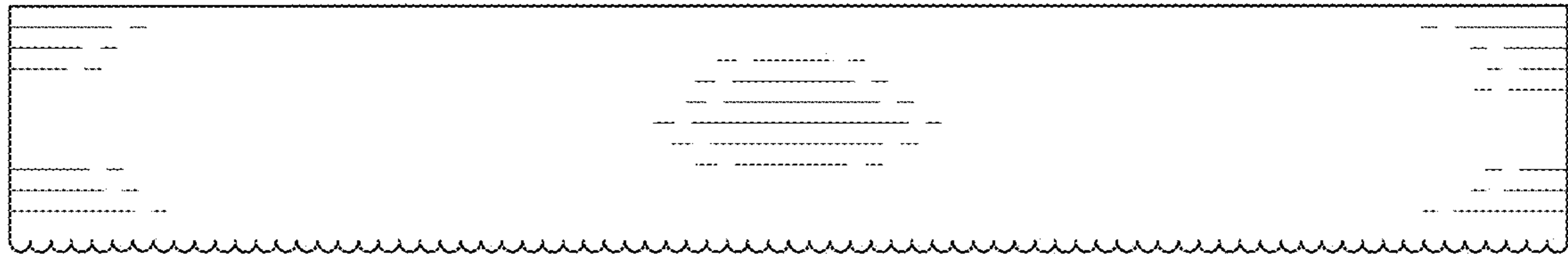

FIG. 4

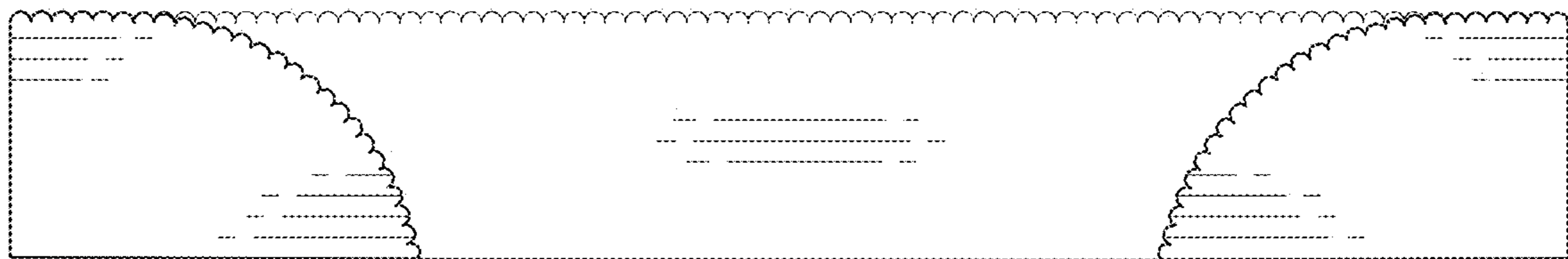

FIG. 5

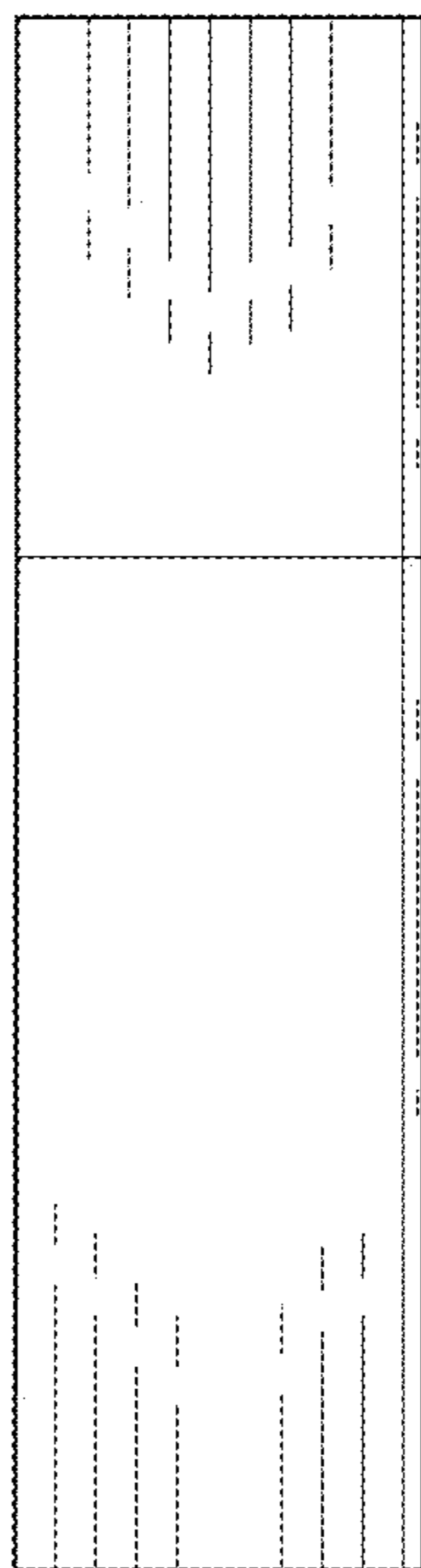

FIG. 6

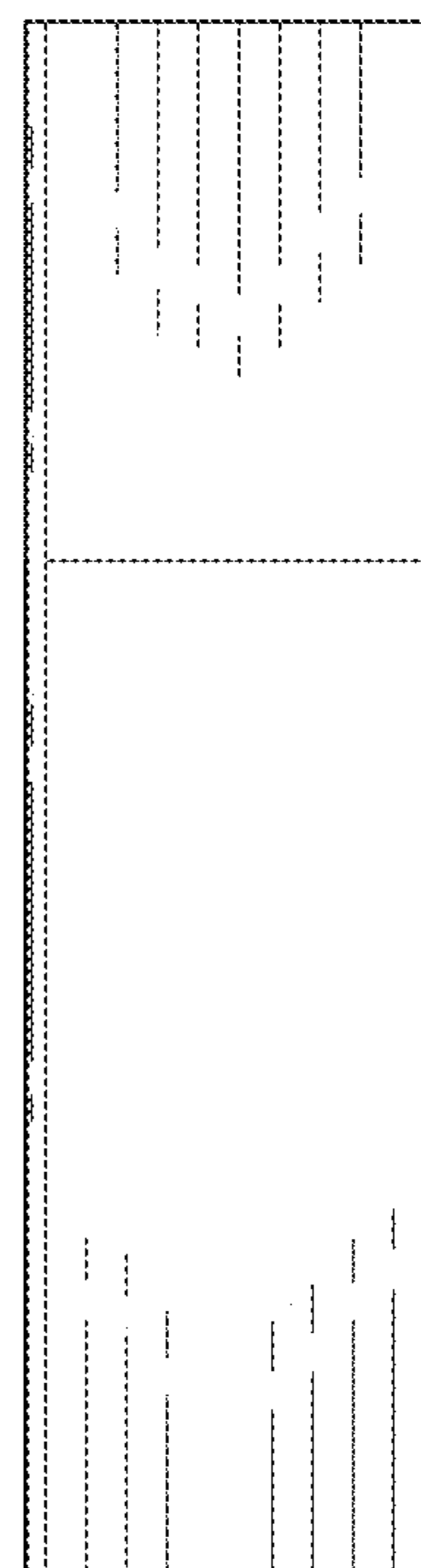

FIG. 7