



US00D930759S

(12) **United States Design Patent**
Wood et al.

(10) **Patent No.:** **US D930,759 S**
(45) **Date of Patent:** **** Sep. 14, 2021**

(54) **MODEL VEHICLE TRACK ASSEMBLY**

D310,985 S 10/1990 Covert et al.
D313,582 S 1/1991 Tsutsumi et al.
D316,689 S 5/1991 Fujiki

(71) Applicant: **TRAXXAS LP**, McKinney, TX (US)

(Continued)

(72) Inventors: **Jonathan Scott Wood**, Lewisville, TX (US); **Jory Sprowl**, Honey Grove, TX (US); **Otto Karl Allmendinger**, Rowlett, TX (US)

OTHER PUBLICATIONS

Traxxas TRX-4 1/8 Scale Trail Rock Crawler w/All-Terrain Traxx [Jun. 22, 2020]. Found online Jun. 22, 2020 at <https://redlinehobby.ca/shop/traxxas-traxx-trx-4-4-complete-set-front-rear-order-on-demand> (Year: 2020).

(Continued)

(73) Assignee: **TRAXXAS LP**, McKinney, TX (US)

(**) Term: **15 Years**

(21) Appl. No.: **29/675,081**

Primary Examiner — Cynthia M. Chin

(22) Filed: **Dec. 28, 2018**

(74) *Attorney, Agent, or Firm* — Daryl R. Wright; Greg Carr

(51) **LOC (13) Cl.** **21-01**

(52) **U.S. Cl.**

(57) **CLAIM**

USPC **D21/561**

We claim the ornamental design for a model vehicle track assembly, as shown and described.

(58) **Field of Classification Search**

USPC D21/533, 539, 561, 563; D15/28; D12/1
CPC A63H 17/14; B62D 55/065; B62D 55/075
See application file for complete search history.

DESCRIPTION

(56) **References Cited**

U.S. PATENT DOCUMENTS

D115,835 S	7/1939	Lombard	
D208,685 S	9/1967	Evans, Jr.	
3,427,746 A *	2/1969	Jacobs	A63H 17/26 446/433
D260,012 S	7/1981	Candiliotis	
D261,257 S	10/1981	Guidry	
D266,919 S	11/1982	Bennett	
D268,663 S	4/1983	Bennett	
4,448,273 A *	5/1984	Barbieri	B62D 55/065 180/9.21
4,483,407 A *	11/1984	Iwamoto	B62B 5/02 180/6.54
D296,200 S	6/1988	Elsesser	
D296,544 S	7/1988	Matsushita et al.	
D301,859 S	6/1989	Igarashi	
D301,999 S	7/1989	Fujiki	
D309,442 S	7/1990	Okada	

FIG. 1 is an upper, left, front perspective view of a model vehicle track assembly, showing our new design;

FIG. 2 is front elevation view thereof;

FIG. 3 is a rear elevation view thereof;

FIG. 4 is a left side elevation view thereof;

FIG. 5 is a right side elevation view thereof;

FIG. 6 is an upper plan view thereof;

FIG. 7 is a lower plan view thereof; and,

FIG. 8 is an upper, left, front perspective environmental use view.

In the drawings, the broken lines are for the purpose of illustrating portions of the article that form no part of the claimed design.

In the drawings, the representative model vehicle track assembly depicted is a left model vehicle tract assembly. The right rear model vehicle track assembly is a mirror image of the left rear model vehicle track assembly.

1 Claim, 7 Drawing Sheets

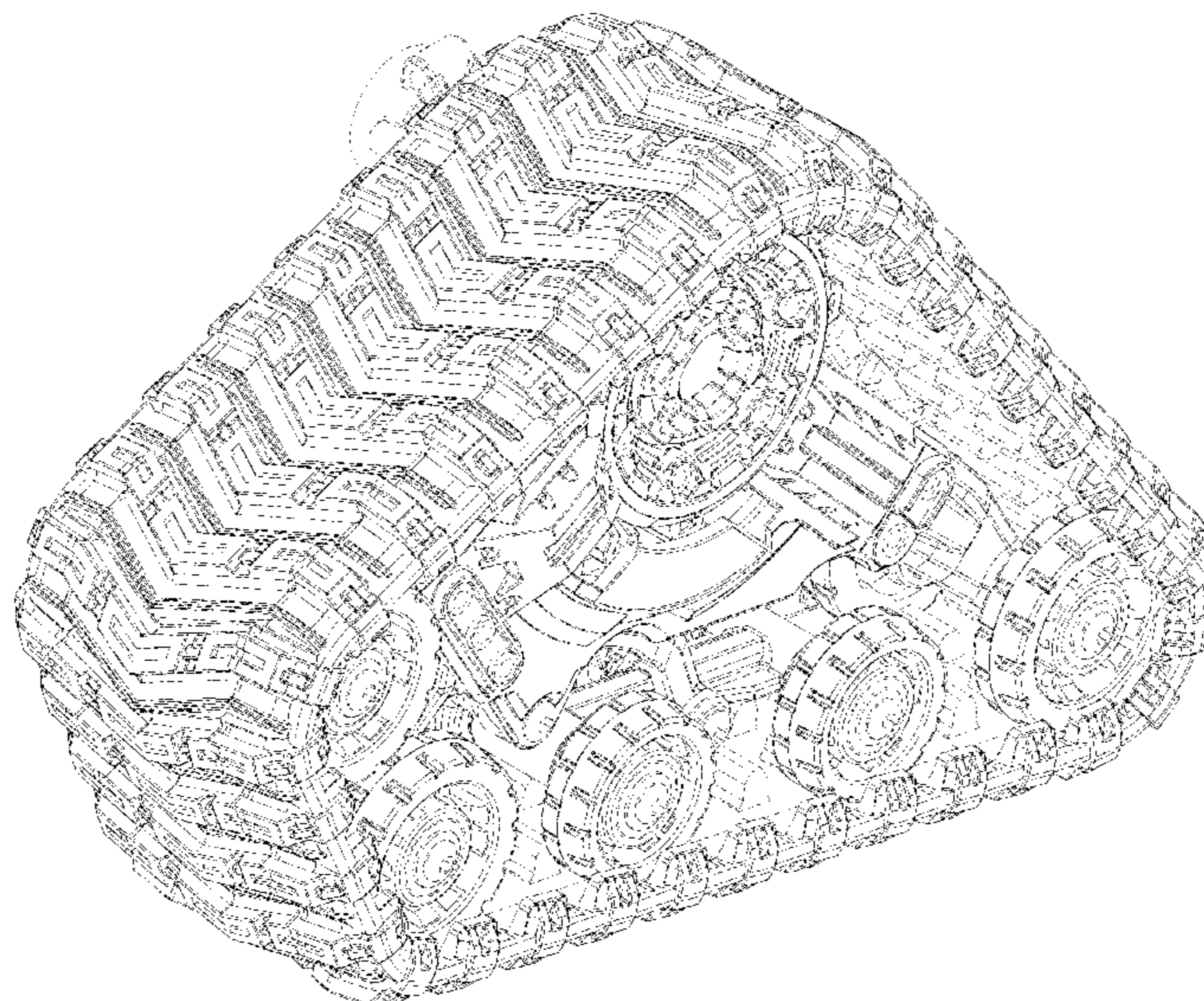

(56)

References Cited

U.S. PATENT DOCUMENTS

D316,695 S	5/1991	Fujiki		D603,880 S	11/2009	Brazier	
5,135,427 A *	8/1992	Suto	A63H 17/14	D604,689 S	11/2009	Frappart et al.	
			180/6.7	D612,797 S	3/2010	Lo	
D329,413 S	9/1992	Chandler		D612,799 S	3/2010	Wallet et al.	
D329,885 S *	9/1992	Maarschalkerweerd	D21/539	D618,160 S	6/2010	Jacobs	
5,259,429 A	11/1993	Harms		D619,529 S	7/2010	Gerard Georges et al.	
5,261,853 A *	11/1993	Suto	A63H 17/14	D621,342 S	8/2010	Osaka	
			180/9.1	D627,709 S	11/2010	Harvey et al.	
5,273,126 A	12/1993	Reed et al.		D632,244 S	2/2011	Green	
5,607,210 A	3/1997	Brazier		D634,265 S	3/2011	Shan et al.	
D379,442 S	5/1997	Ratliff, Jr.		D636,793 S	4/2011	Vladimirovich	
D384,013 S	9/1997	Thomas		D639,313 S	6/2011	Vladimirovich	
D390,178 S	2/1998	Maxwell		D653,195 S	1/2012	Sareen	
D391,211 S	2/1998	Maxwell		D653,196 S	1/2012	Buchinger-Barnstorf	
D395,627 S	6/1998	Ball et al.		D653,198 S	1/2012	Buchinger-Barnstorf	
D400,141 S	10/1998	Maxwell		D653,681 S	2/2012	Degtyarev	
D408,326 S	4/1999	Dandurand		D668,204 S	10/2012	Leendertse et al.	
D408,327 S	4/1999	Dandurand		D671,486 S	11/2012	Rooney et al.	
D425,526 S	5/2000	Juncker et al.		D673,895 S	1/2013	Smith et al.	
D428,587 S	7/2000	Maxwell		D676,799 S	2/2013	Sanae	
6,116,362 A *	9/2000	Schubert	B62D 11/20	D691,943 S	10/2013	Ma	
			180/9.44	8,632,138 B2 *	1/2014	Besette	B62D 55/14
							305/142
6,142,200 A	11/2000	Feider et al.		D706,707 S	6/2014	Jacobs	
6,176,334 B1 *	1/2001	Lorenzen	B62D 21/14	D707,620 S	6/2014	Barajas et al.	
			180/9.46	D709,435 S	7/2014	Jacobs	
D440,913 S	4/2001	McMannis		D709,436 S	7/2014	Ikeki	
D441,697 S	5/2001	Allison		D711,928 S *	8/2014	Brazier	D15/28
D445,379 S	7/2001	Guspodin et al.		D713,328 S	9/2014	Umstot et al.	
D445,381 S	7/2001	Guspodin et al.		D719,083 S	12/2014	Hayashi	
D456,344 S	4/2002	Rooney		D720,683 S	1/2015	Boore et al.	
6,401,847 B1	6/2002	Lykken		D730,272 S	5/2015	Fleckner	
D468,370 S *	1/2003	Hattori	D21/539	D732,463 S	6/2015	Petr et al.	
6,557,953 B1	5/2003	Kahle et al.		D743,874 S	11/2015	Philipot et al.	
D483,718 S	12/2003	Hutz		D744,412 S	12/2015	Schimmoeller	
D487,057 S	2/2004	Rooney et al.		D746,763 S	1/2016	Kubo	
D488,171 S	4/2004	Juncker et al.		D751,030 S	3/2016	Chen	
D488,430 S	4/2004	Maxwell		D753,055 S	4/2016	Sato et al.	
D492,644 S	7/2004	Maxwell		D753,056 S	4/2016	Kuwano	
D492,931 S	7/2004	Maxwell et al.		D756,898 S	5/2016	Kristen	
D496,328 S	9/2004	Shondel et al.		D767,474 S	9/2016	Reim et al.	
D497,621 S *	10/2004	Inaoka	D15/28	9,452,796 B2	9/2016	Franck et al.	
D500,010 S	12/2004	Maziarka et al.		D768,033 S	10/2016	Degtyarev	
D504,656 S	5/2005	Green et al.		D768,034 S	10/2016	Degtyarev	
D505,136 S *	5/2005	Brazier	B62D 55/14	D770,970 S	11/2016	Kuwano et al.	
			D15/28	D773,385 S	12/2016	Kuwano	
D505,382 S	5/2005	Green et al.		D775,061 S	12/2016	Ishiguro et al.	
D505,385 S	5/2005	Green et al.		D780,674 S	3/2017	Chen	
6,920,906 B2	7/2005	Allison et al.		D781,777 S	3/2017	Hayashi	
D508,674 S	8/2005	Dumigan et al.		D783,510 S	4/2017	Thornburg	
D511,738 S	11/2005	Maxwell		D785,548 S	5/2017	Fukunaga et al.	
D512,369 S	12/2005	Lo		D788,687 S	6/2017	Williams et al.	
D512,959 S	12/2005	Fukunaga		D791,687 S	7/2017	Sueyoshi	
D514,501 S	2/2006	Nishimori		D795,796 S	8/2017	Johnson	
D522,450 S	6/2006	Gerasimczuk		D796,426 S	9/2017	Liu	
D524,725 S	7/2006	Gerasimczuk		D798,912 S *	10/2017	Doyle	D15/28
D528,133 S *	9/2006	Brazier	D15/28	D806,640 S	1/2018	Petr	
D534,485 S	1/2007	Nakamura		D810,002 S	2/2018	Sprawl et al.	
D534,487 S	1/2007	Dumigan et al.		D810,669 S	2/2018	Johnson	
D535,248 S	1/2007	Ashton et al.		D813,791 S	3/2018	Wang et al.	
D535,610 S	1/2007	Morito et al.		D816,018 S	4/2018	Chiang et al.	
D535,611 S	1/2007	Sundkvist et al.		D818,424 S	5/2018	Podlovits	
D544,830 S	6/2007	Umstot et al.		D824,458 S *	7/2018	Vaarsi	D21/533
D555,076 S	11/2007	Sakakibara et al.		D832,368 S	10/2018	Barajas et al.	
D555,077 S	11/2007	Lo		D838,662 S	1/2019	Tikka et al.	
D556,673 S	12/2007	Missik-Gaffney et al.		D840,478 S	2/2019	Sprawl et al.	
D556,674 S	12/2007	Missik-Gaffney et al.		D844,547 S	4/2019	Sakamoto et al.	
D560,596 S	1/2008	Sakakibara et al.		D845,224 S	4/2019	Kochanek	
D568,233 S	5/2008	Dixon et al.		D847,729 S	5/2019	Kujime	
D577,658 S	9/2008	Murata		D849,677 S	5/2019	Sakamoto et al.	
D578,956 S	10/2008	Dixon et al.		D856,268 S	8/2019	Sprawl et al.	
D580,347 S	11/2008	Lo		D858,426 S	9/2019	Geng et al.	
D593,135 S *	5/2009	Hansen	D15/28	D859,294 S	9/2019	Taylor	
D594,401 S	6/2009	Guidry		D859,298 S	9/2019	Geng et al.	
D601,487 S	10/2009	Ebel et al.		D877,055 S	3/2020	Christensen et al.	
				D879,020 S	3/2020	Sato et al.	
				D892,715 S	8/2020	Sato	
				D902,963 S *	11/2020	Wood	D15/28

(56)

References Cited

U.S. PATENT DOCUMENTS

2013/0078888 A1* 3/2013 Mayer A63H 11/00
446/433
2017/0036714 A1* 2/2017 Lunkenbein B62D 55/065
2019/0144054 A1* 5/2019 Bliss B62D 55/065
280/5.22
2020/0114801 A1* 4/2020 Bering A01M 7/0085
2020/0324837 A1* 10/2020 Weyer B62D 55/104

OTHER PUBLICATIONS

TRAXXAS; Tires, Maxx AT; Sep. 2016.

Traxxas [online] found Jan. 2, 2018 from URL <https://traxxas.com/products/parts/8369B1=overview>.

Screenshot and detail from Traxxas.com: Tires and wheels, assembled, glued (2.6" black, satin chrome-plated Mercedes-Benz G 500 4x42 wheels, 2.6" tires(2)/center caps (2) (requires #8255A extended stub axle). Undated; one page. Found online Nov. 6, 2019 at <https://traxxas.com/products/parts/8872> (Year: 2019).

Traxxas TRX-4 1/10 Scale Trail Rock Crawler (Orange) w/All-Terrain Traxx [Nov. 5, 2019] found online [Nov. 5, 2019]—Traxxas TRX-4 1/10 Scale Trail Rock Crawler (Orange) w/All-Terrain Traxx.

“Goodyear Tires, “Wrangler MT/R”, Jun. 29, 2007, web page;http://www.goodyeartires.com/goodyeartireselector/display_tire.jsp?prodline=Wrangler+MT%2FR&mrktarea=LightTruck&treadwidth=&aspectratio=&rimdiameter=&sidewall”.

* cited by examiner

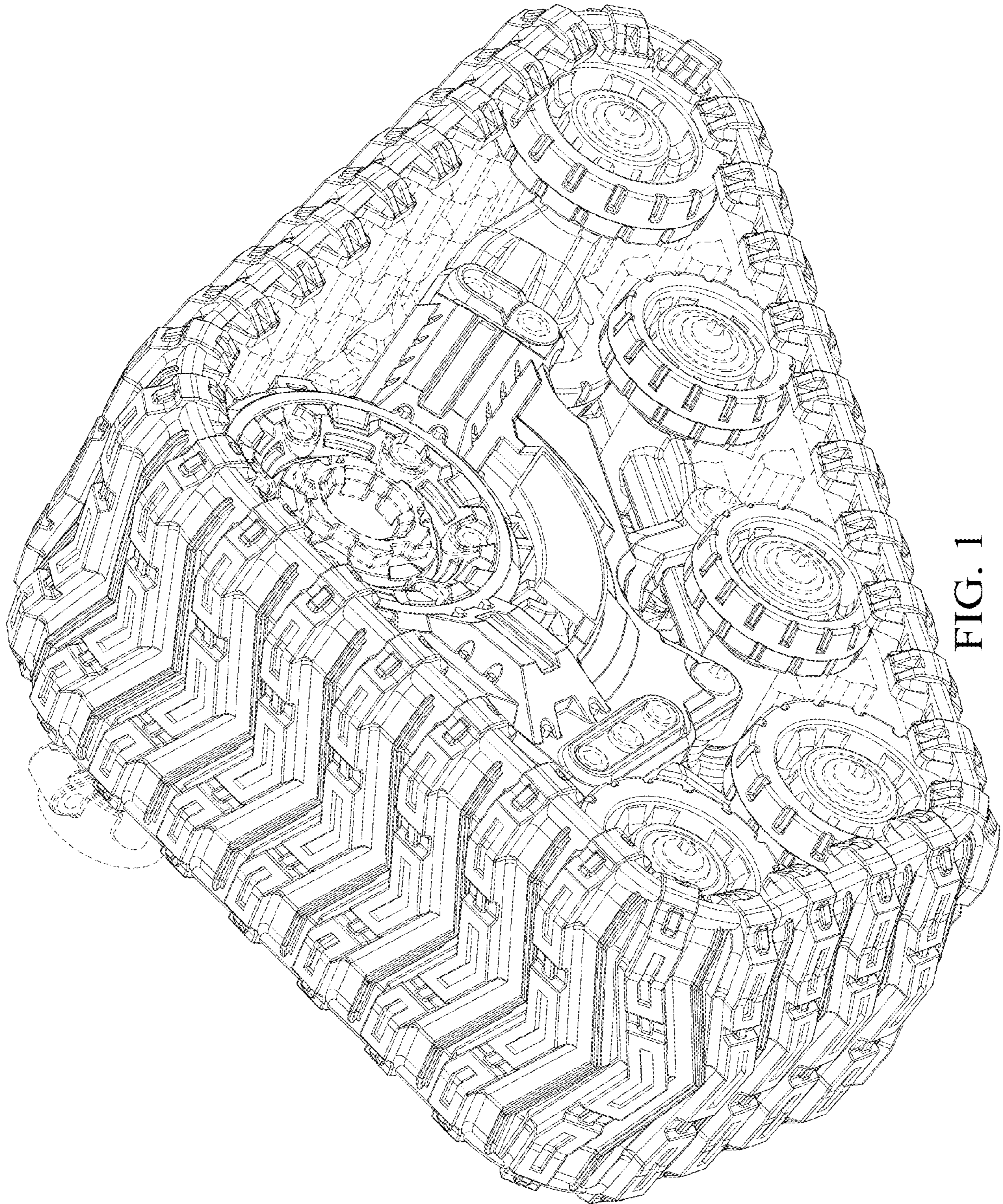

FIG. 1

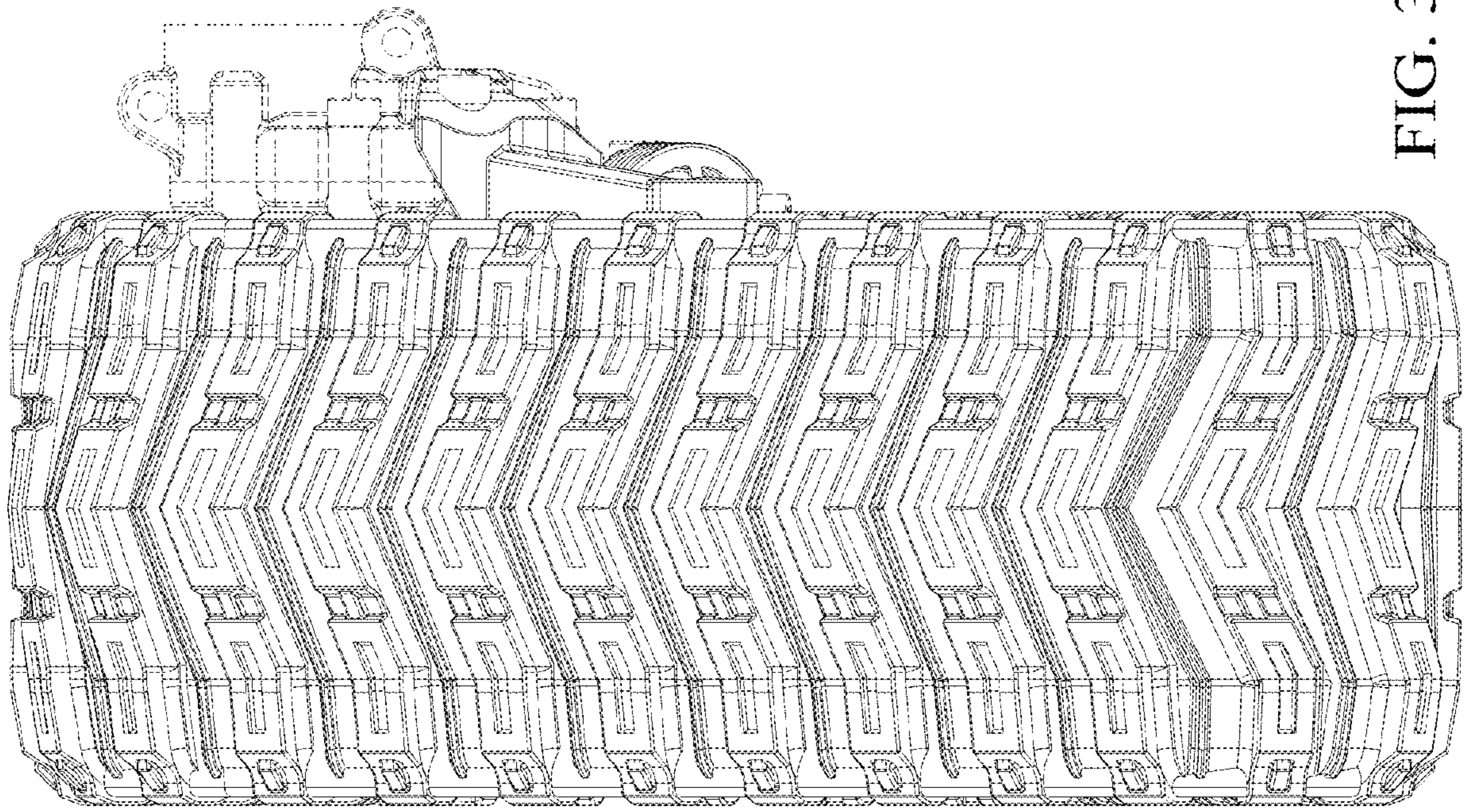

FIG. 3

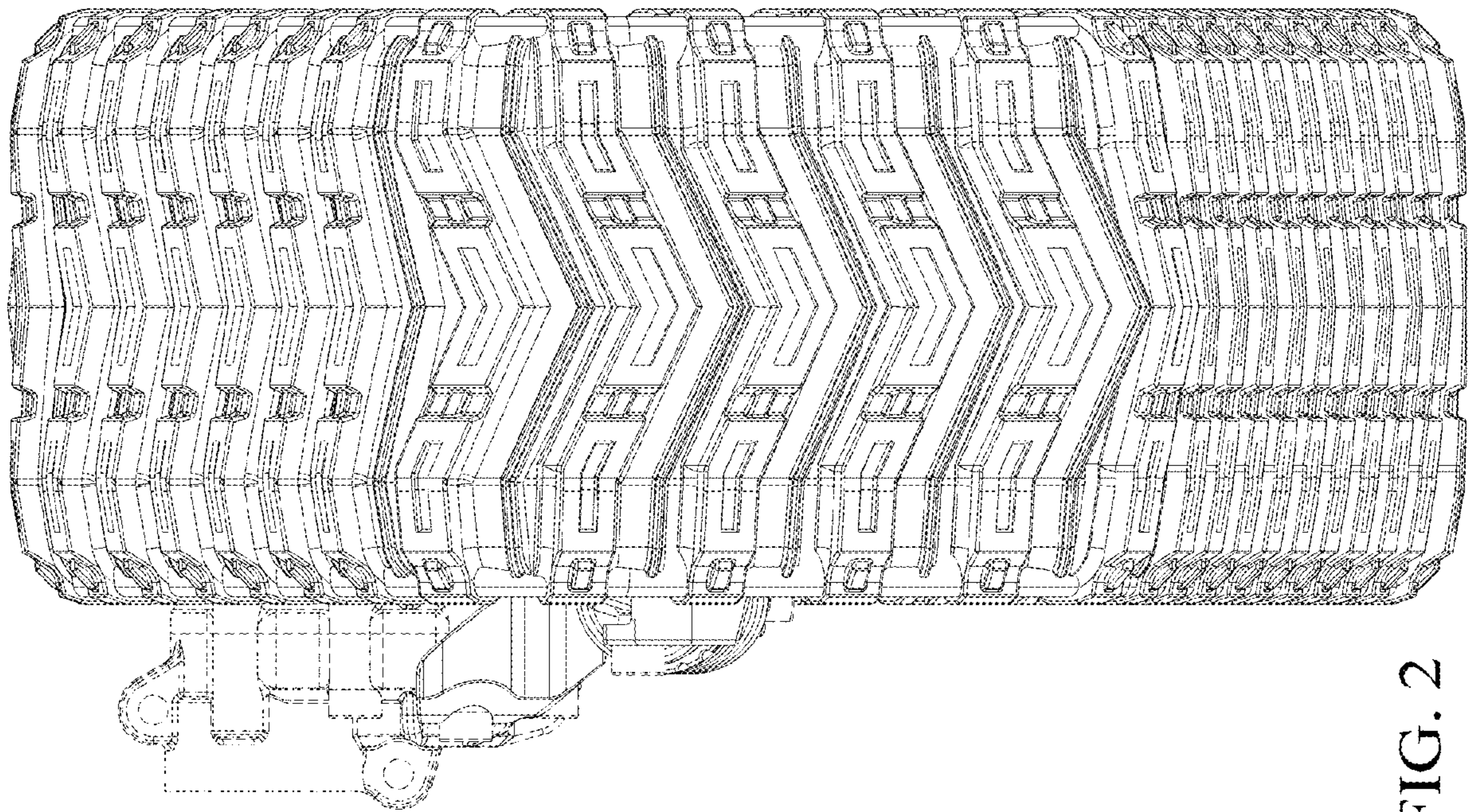

FIG. 2

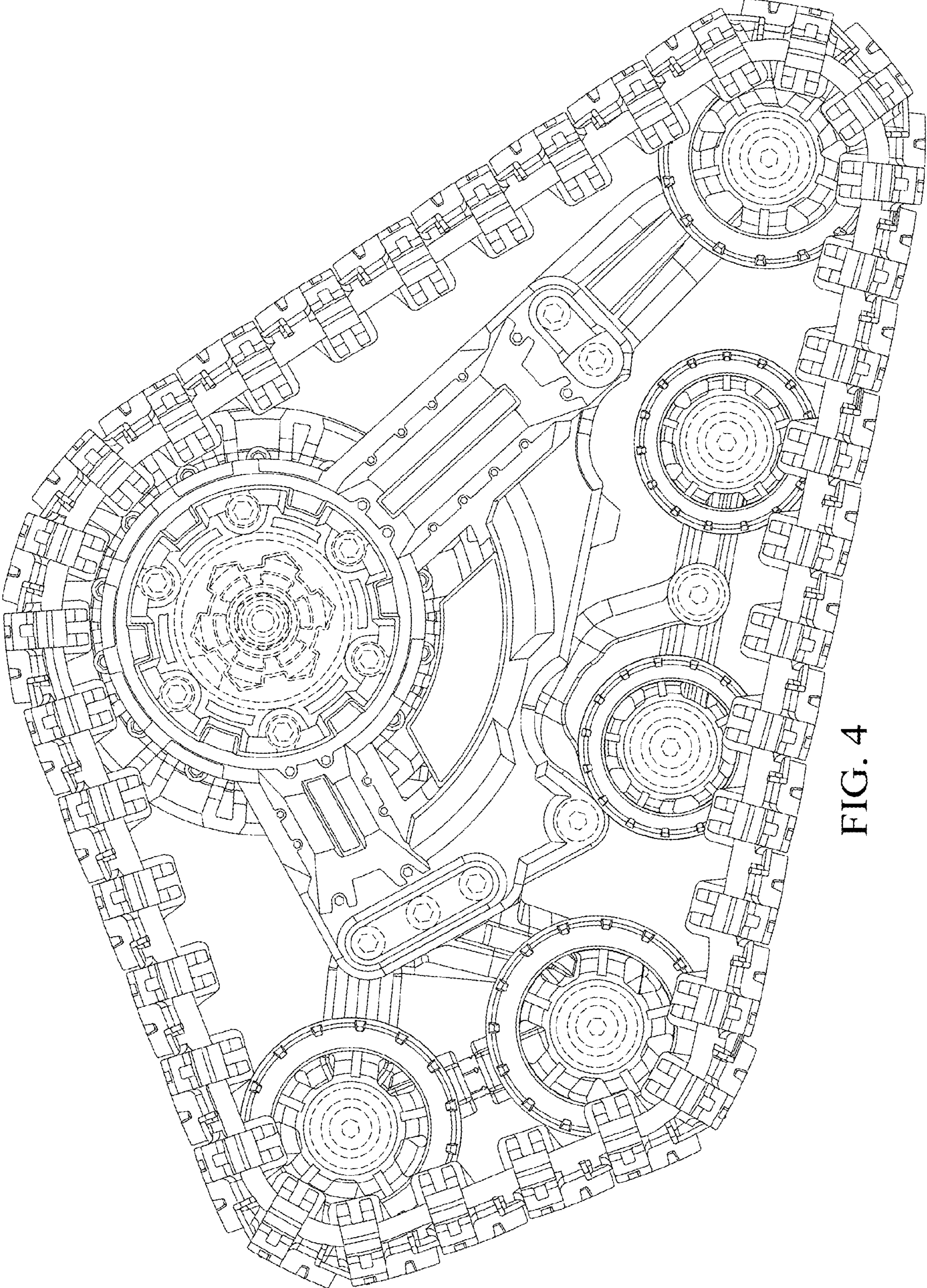

FIG. 4

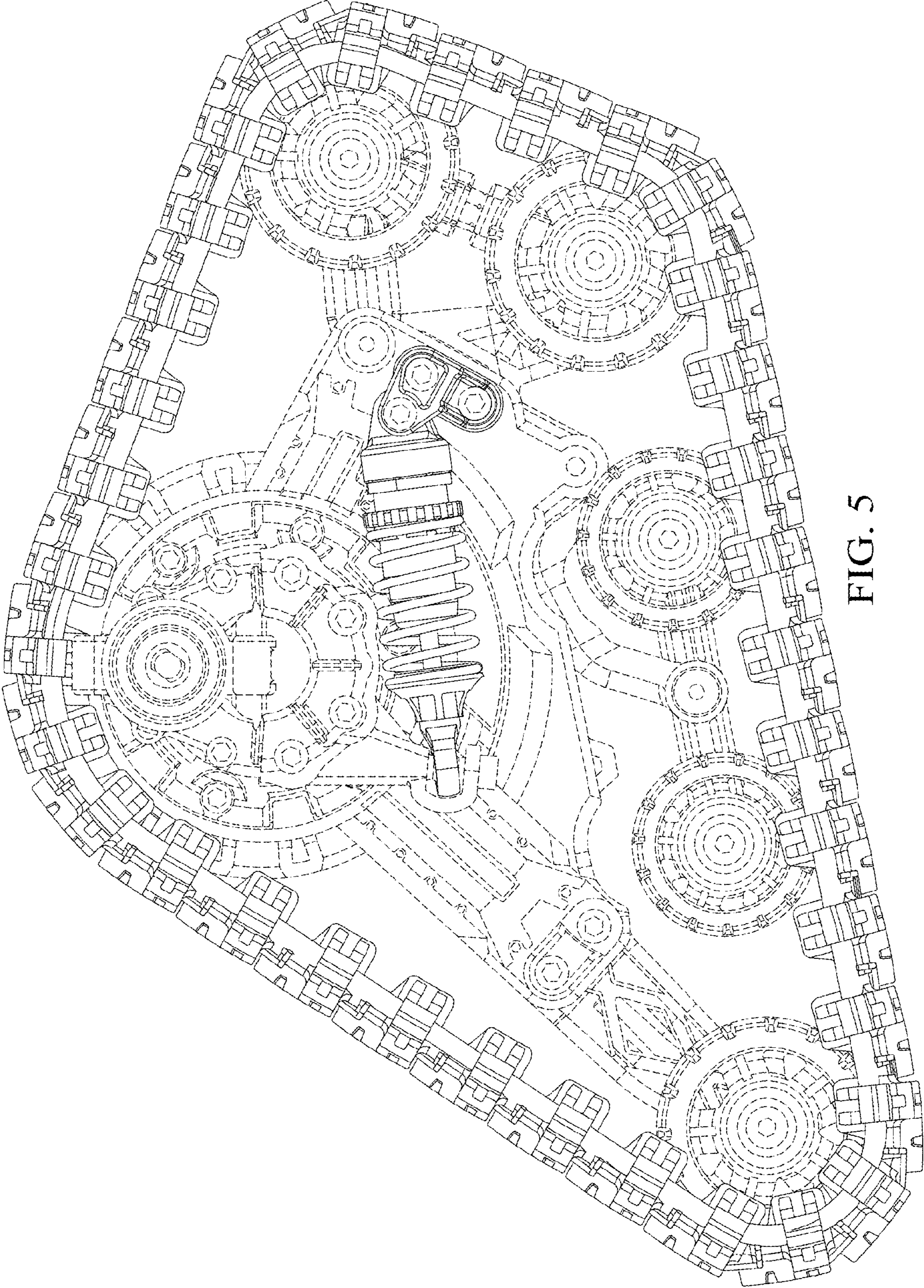

FIG. 5

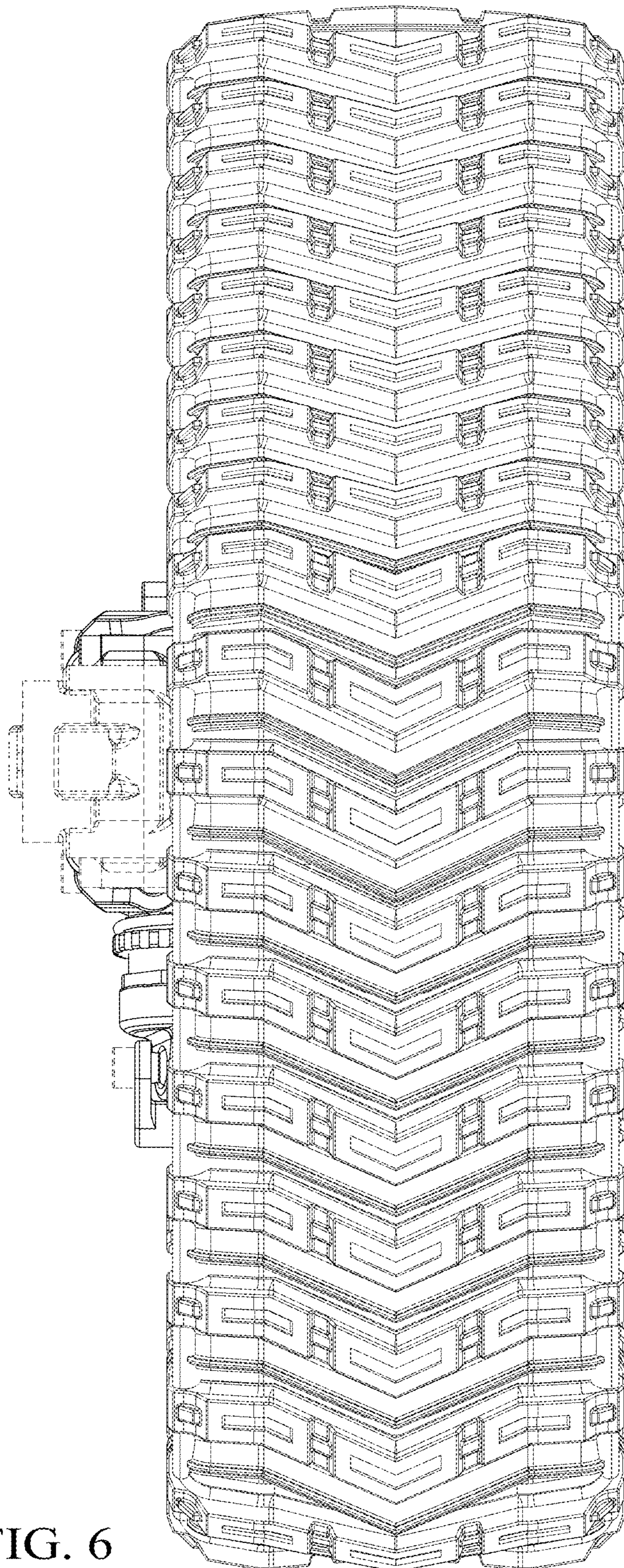

FIG. 6

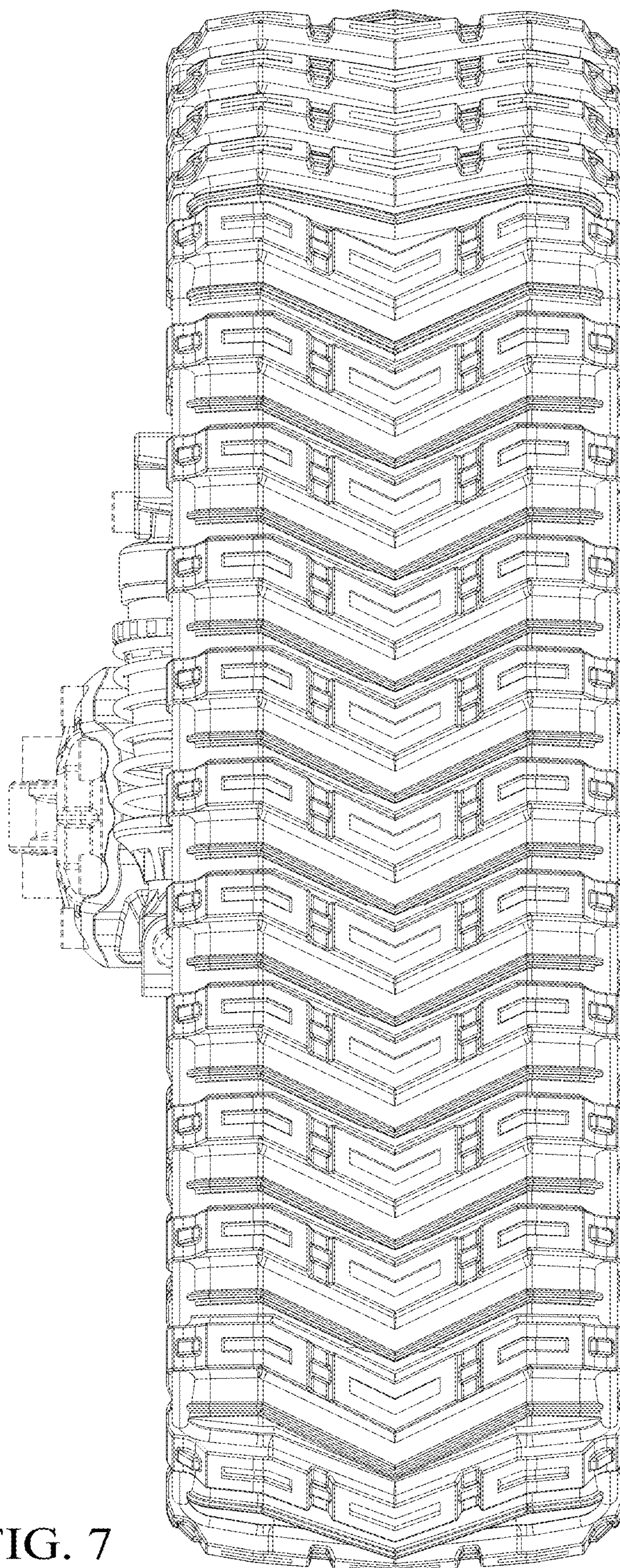

FIG. 7

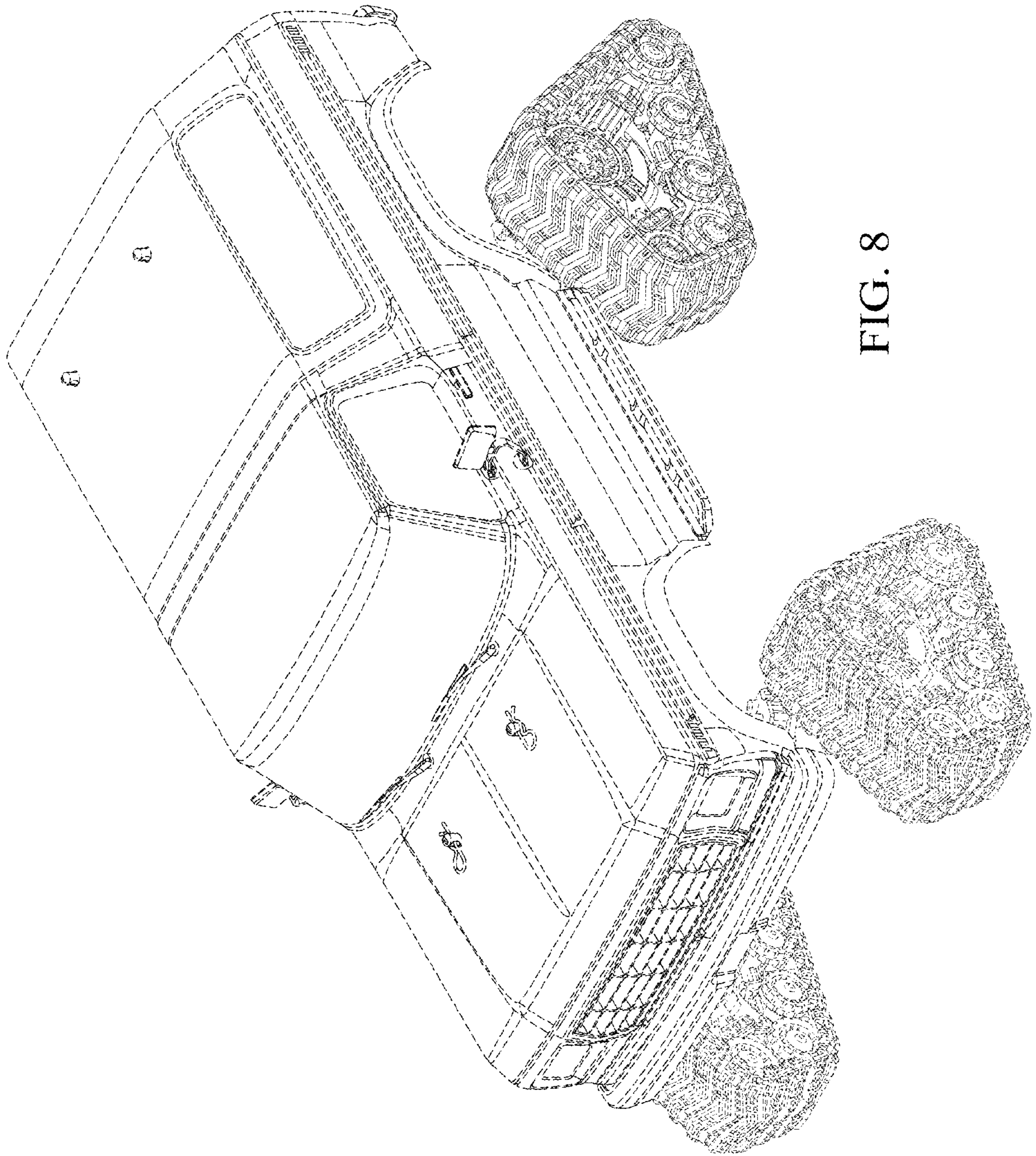

FIG. 8