



US00D930644S

(12) **United States Design Patent** (10) **Patent No.:** **US D930,644 S**
Nie et al. (45) **Date of Patent:** **** Sep. 14, 2021**

(54) **SMART WRISTWATCH**

(71) Applicant: **GUANGDONG GENIUS TECHNOLOGY CO., LTD.**, Dongguan (CN)

(72) Inventors: **Dong Nie**, Dongguan (CN); **Yu Shi**, Dongguan (CN); **Haisheng Zhao**, Dongguan (CN)

(73) Assignee: **GUANGDONG GENIUS TECHNOLOGY CO., LTD.**, Dongguan (CN)

(**) Term: **15 Years**

(21) Appl. No.: **29/698,536**

(22) Filed: **Jul. 17, 2019**

(30) **Foreign Application Priority Data**

Jan. 18, 2019 (CN) 201930053063.7

(51) **LOC (13) Cl.** **14-02**

(52) **U.S. Cl.**
USPC **D14/341**; D14/344

(58) **Field of Classification Search**
USPC ... D14/126-130, 138, 138 R, 144, 300, 341, D14/344, 358, 388, 485-495, 218; D10/30-39, 40, 41, 46, 70, 79, 98, 106.5, D10/106.6, 106.92, 106.94, 114.6, 123, D10/125-128, 131; D11/1-4, 26, 40-41, D11/93, 94, 78.1, 79, 86; D24/167-169, D24/186-187, 164; D21/324-329
CPC A41D 1/002; A41D 19/0034; G06F 1/08; G06F 1/10; G06F 1/14; G06F 1/1626; G06F 1/1628; G06F 1/163; G06F 1/1635; G06F 1/3203; G06F 1/1613; G06F 2200/1633; G06F 3/0488; G06F 3/04886; G06F 3/044; G06F 3/0412; G06F 3/0416; G06Q 20/10; G06Q 20/12; G06Q 20/108; G06Q 20/145;

(Continued)

(56) **References Cited**

U.S. PATENT DOCUMENTS

D301,692 S * 6/1989 Wakamatsu D10/30
D390,789 S * 2/1998 Sugita D10/30

(Continued)

FOREIGN PATENT DOCUMENTS

CN 202030093022.3 * 3/2020

OTHER PUBLICATIONS

Imoo Watch Phone Z6 kids Smartwatch, first available Oct. 9, 2020, amazon.co.uk, [online], [site visited Jan. 19, 2021], Available from internet URL:https://www.amazon.co.uk/imoo-Watch-Phone-Z6-Smart-Purple/dp/B08L18X5TV?th=1 (Year: 2020).*

(Continued)

Primary Examiner — Samantha Q Lawrence

Assistant Examiner — Holly M Rodriguez

(74) *Attorney, Agent, or Firm* — Yong Chen

(57) **CLAIM**

The ornamental design for a smart wristwatch, as shown and described.

DESCRIPTION

FIG. 1 is a front view of a smart wristwatch showing my new design;
FIG. 2 is a rear side elevation view thereof;
FIG. 3 is a left side elevation view thereof;
FIG. 4 is a right side elevation view thereof;
FIG. 5 is a top plan view thereof;
FIG. 6 is a bottom plan view thereof;
FIG. 7 is a perspective view thereof;
FIG. 8 is a perspective view of the smart wristwatch in a first detached and rotated position; and,
FIG. 9 is a perspective view of the smart wristwatch in a second detached and rotated position.

1 Claim, 7 Drawing Sheets

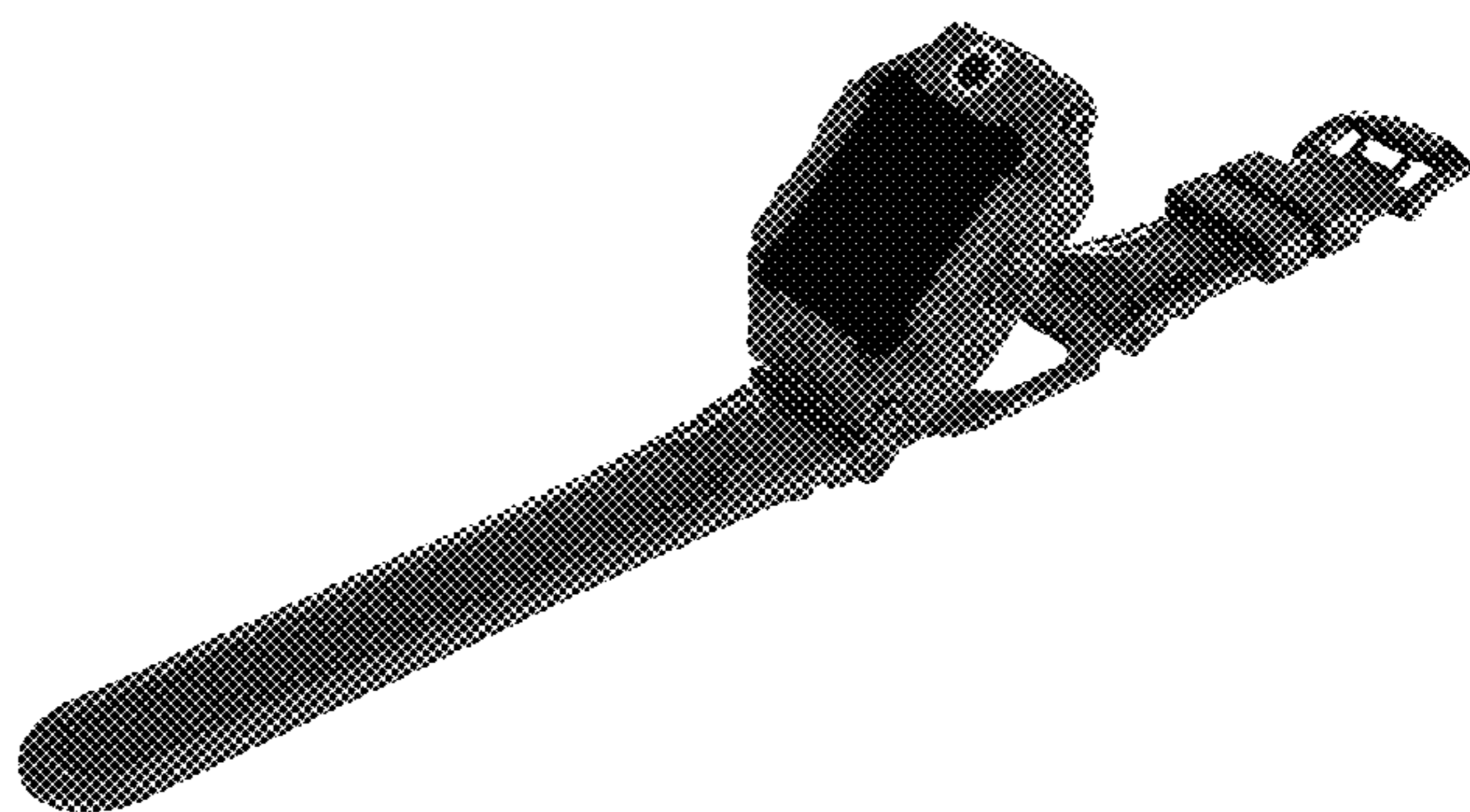
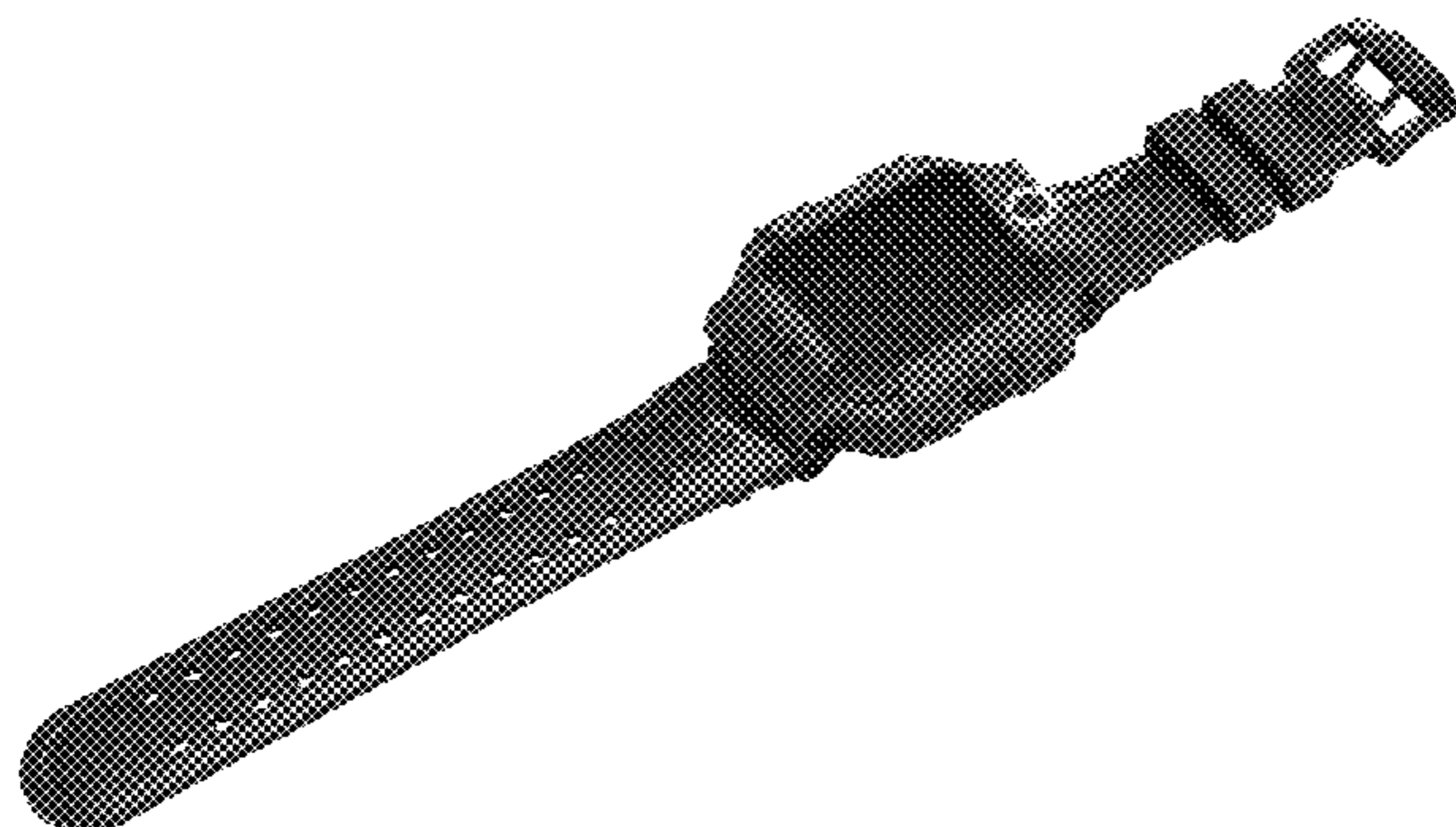

(58) **Field of Classification Search**

CPC H04B 1/3833; H04B 1/385; H04B 1/3888;
H04M 1/02; H04M 1/03; H04M 1/04;
H04M 1/05; H04M 1/667; H04M 1/6058;
Y02B 60/1217

See application file for complete search history.

(56) **References Cited**

U.S. PATENT DOCUMENTS

D452,006	S	*	12/2001	Komulainen	D10/31
D544,372	S	*	6/2007	Seyr	D10/32
D550,101	S	*	9/2007	Umebayashi	D10/32
D730,199	S	*	5/2015	Gerard-Goddet	D10/32
D742,254	S	*	11/2015	Greusel	D10/30
D742,761	S	*	11/2015	Grazian	D10/30
9,737,123	B2	*	8/2017	Wright	A45C 13/008
D852,648	S	*	7/2019	Chen	D10/32
D856,160	S	*	8/2019	Yu	D10/32
D881,185	S	*	4/2020	He	D14/344
D900,810	S	*	11/2020	Ke	D14/344
2013/0181873	A1	*	7/2013	Gutschenritter	H01Q 1/48 343/718

OTHER PUBLICATIONS

Y99A Kids 360 degree rotating Smartwatch, www.aliexpress.com, [online], [site visited Jan. 19, 2021], Available from internet URL: https://www.aliexpress.com/item/1005001308560983.html?spm=a2g0o.productlist.0.0.676c64d0rIrWC2&algo_pvid=027849a4-fdbc-46ab-a210-82dc%E2%80%A6 (Year: 2021).*

* cited by examiner

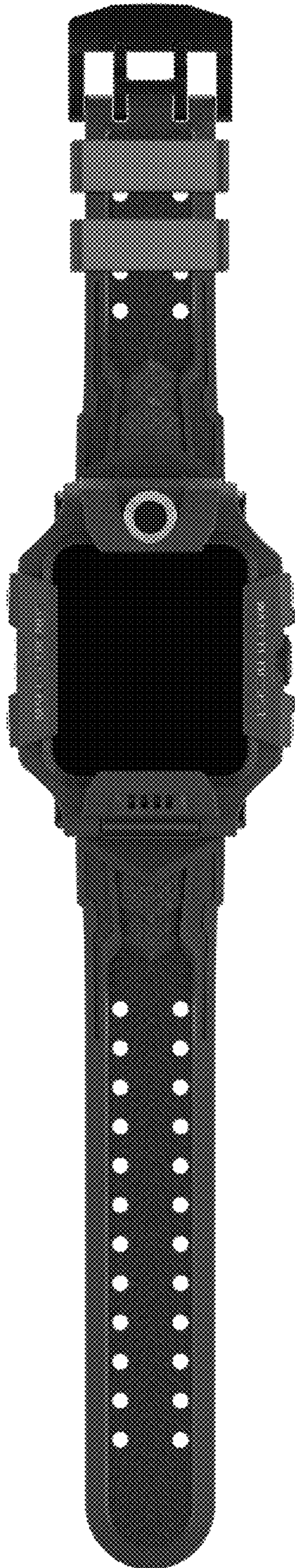

FIG. 1



FIG. 2

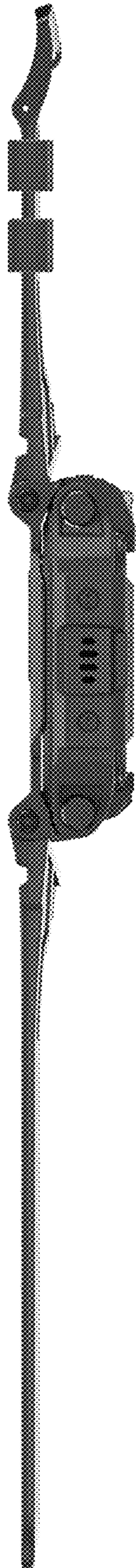

FIG. 3

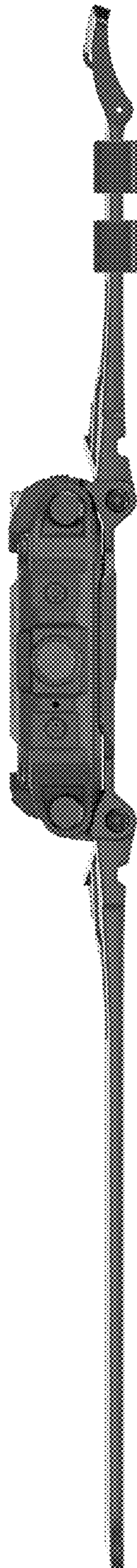

FIG. 4

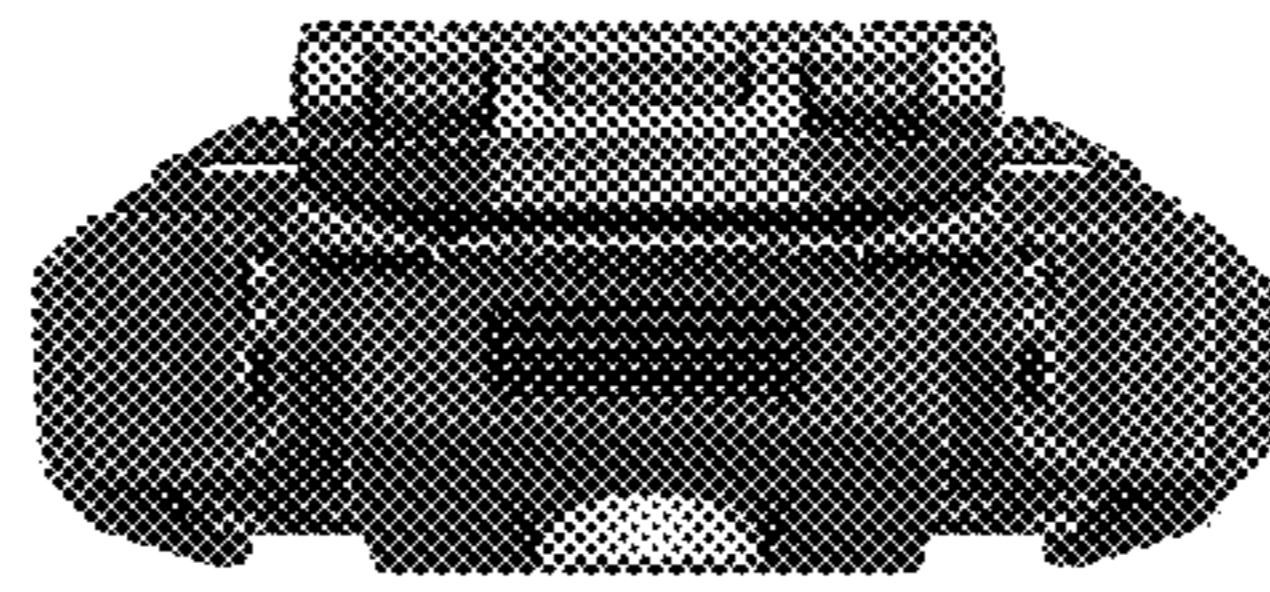

FIG. 5

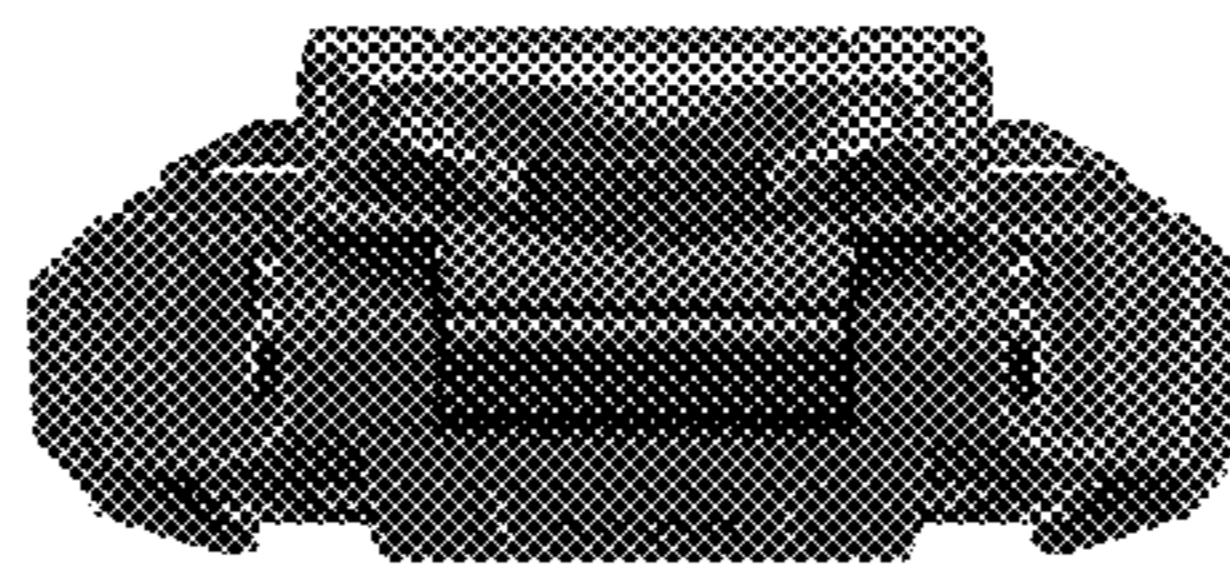

FIG. 6

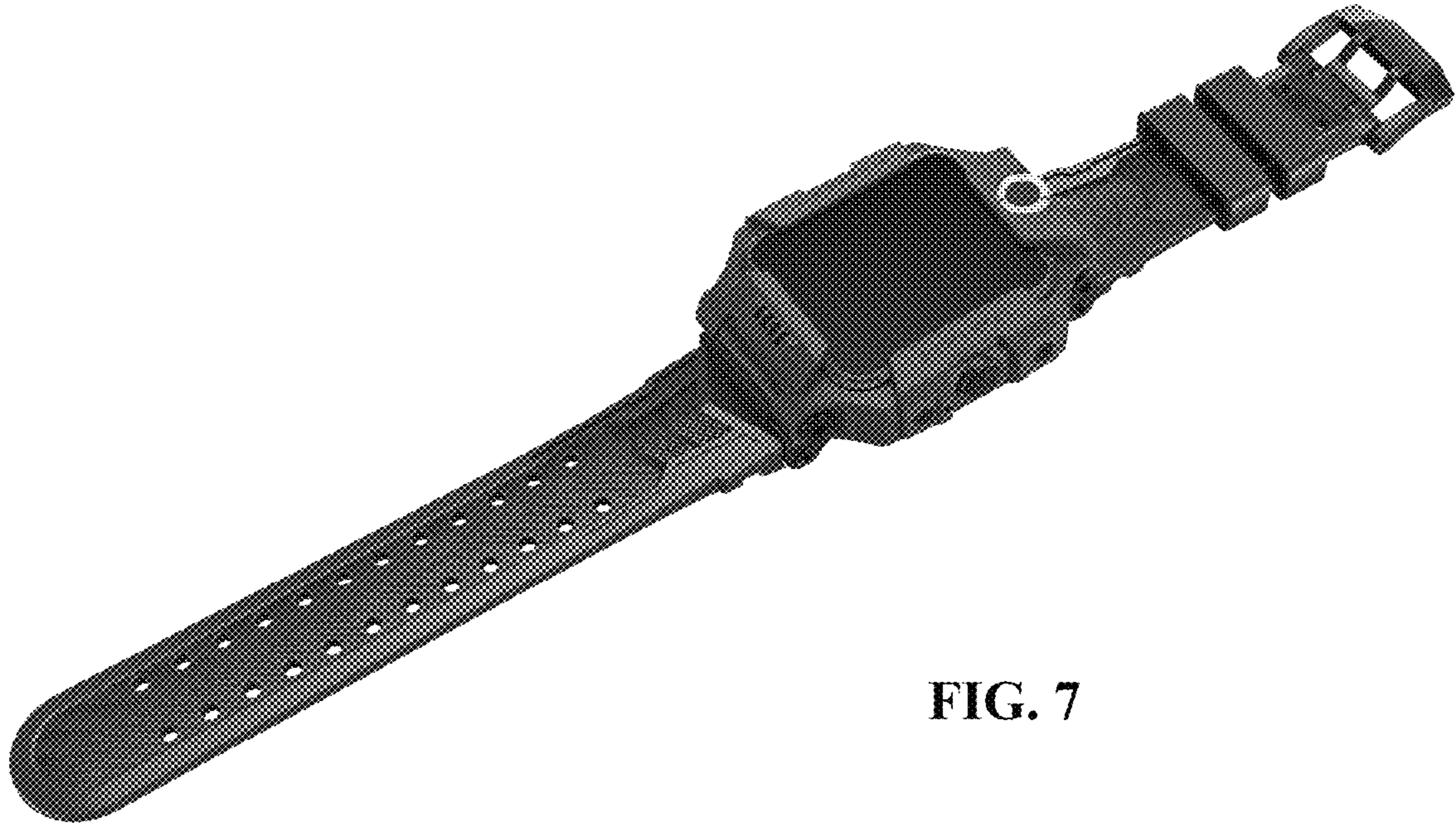

FIG. 7

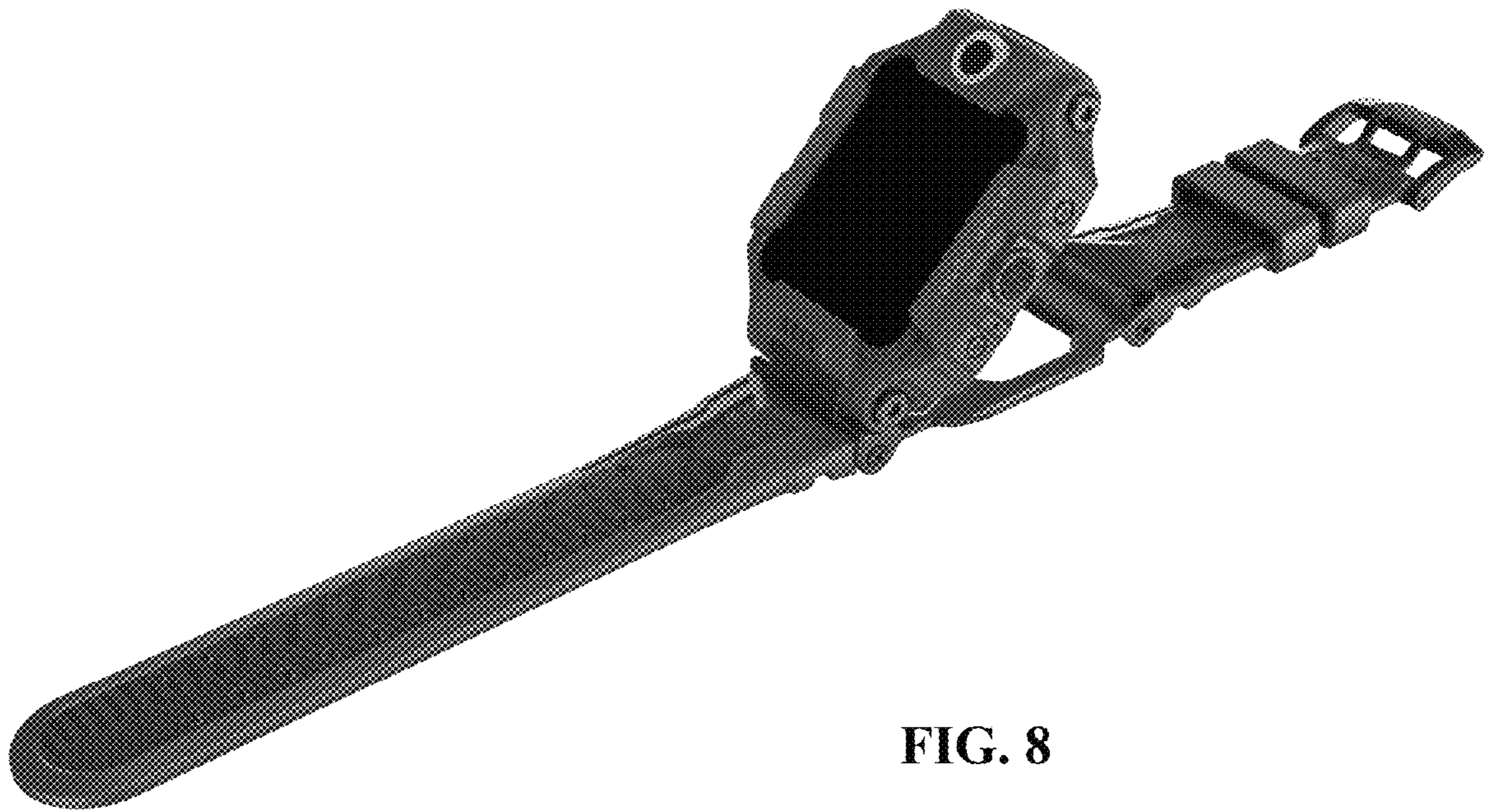

FIG. 8



FIG. 9