



US00D930625S

(12) **United States Design Patent** (10) **Patent No.:** **US D930,625 S**
Lee et al. (45) **Date of Patent:** **** Sep. 14, 2021**

(54) **BASKET FOR A FRAME OF BUILT-IN HOME APPLIANCES**

(71) Applicant: **LG ELECTRONICS INC.**, Seoul (KR)

(72) Inventors: **Bumsang Lee**, Seoul (KR); **Taeho Kim**, Seoul (KR); **Junghan Ryu**, Seoul (KR); **Chulmin Lim**, Seoul (KR); **Mijin Jung**, Seoul (KR); **Junghyun Joo**, Seoul (KR); **Jipyoo Hong**, Seoul (KR)

(73) Assignee: **LG ELECTRONICS INC.**, Seoul (KR)

(**) Term: **15 Years**

(21) Appl. No.: **29/711,952**

(22) Filed: **Nov. 4, 2019**

(51) **LOC (13) Cl.** **14-01**

(52) **U.S. Cl.**
USPC **D14/229; D14/209**

(58) **Field of Classification Search**
USPC D8/349, 354, 355, 374, 381, 400, 499;
D13/162, 164, 171, 177, 199;
D14/125-129, 133, 140, 217, 224, 224.1,
D14/229, 238, 238.1, 239, 299, 317, 331,
D14/336, 337, 341, 371-376, 389, 432,
D14/433, 434, 496, 511; D15/138;
D23/217, 351-355, 357, 361, 385;
D25/61, 118, 126, 131, 141, 156, 161,
D25/162, 199
CPC H01H 9/52; H01H 45/04; H01H 45/12;
H01H 50/12; H01H 2239/036; H05B
6/6447; H05B 6/6473; H05B 6/782;
H05B 47/11; H05B 47/105; H05B
47/155; H05B 47/16; H05B 47/175;
H05B 45/00; H05B

(Continued)

(56) **References Cited**

U.S. PATENT DOCUMENTS

D255,234 S * 6/1980 Wellward 181/150
D303,391 S * 9/1989 Stallings, Jr. D14/209

(Continued)

Primary Examiner — Michael C Stout

Assistant Examiner — Fritzgerald L Butac

(74) *Attorney, Agent, or Firm* — Birch, Stewart, Kolasch & Birch, LLP

(57) **CLAIM**

The ornamental design for a basket for a frame of built-in home appliances, as shown and described.

DESCRIPTION

FIG. 1 is a front perspective view of a basket for a frame of built-in home appliances showing our new design;

FIG. 2 is a front view thereof;

FIG. 3 is a rear view thereof;

FIG. 4 is a left side view thereof;

FIG. 5 is a right side view thereof;

FIG. 6 is a top plan view thereof;

FIG. 7 is a bottom plan view thereof;

FIG. 8 is a back perspective view thereof;

FIG. 9 is a cross-section view taken along the line "9-9", as shown in FIG. 2;

FIG. 10 is a perspective view for reference, showing where the claimed design would mount in an environment of use;

FIG. 11 is another perspective view for reference, showing the claimed design mounted in an environment of use; and,

FIG. 12 is a reference enlarged view of the upper left part of the FIG. 11.

The dash-dot broken lines define the boundary of the claimed design and form no part thereof. The broken lines seen in FIGS. 10, 11, and 12 are for the purpose of showing environmental structure, and form no part of the claimed design.

1 Claim, 12 Drawing Sheets

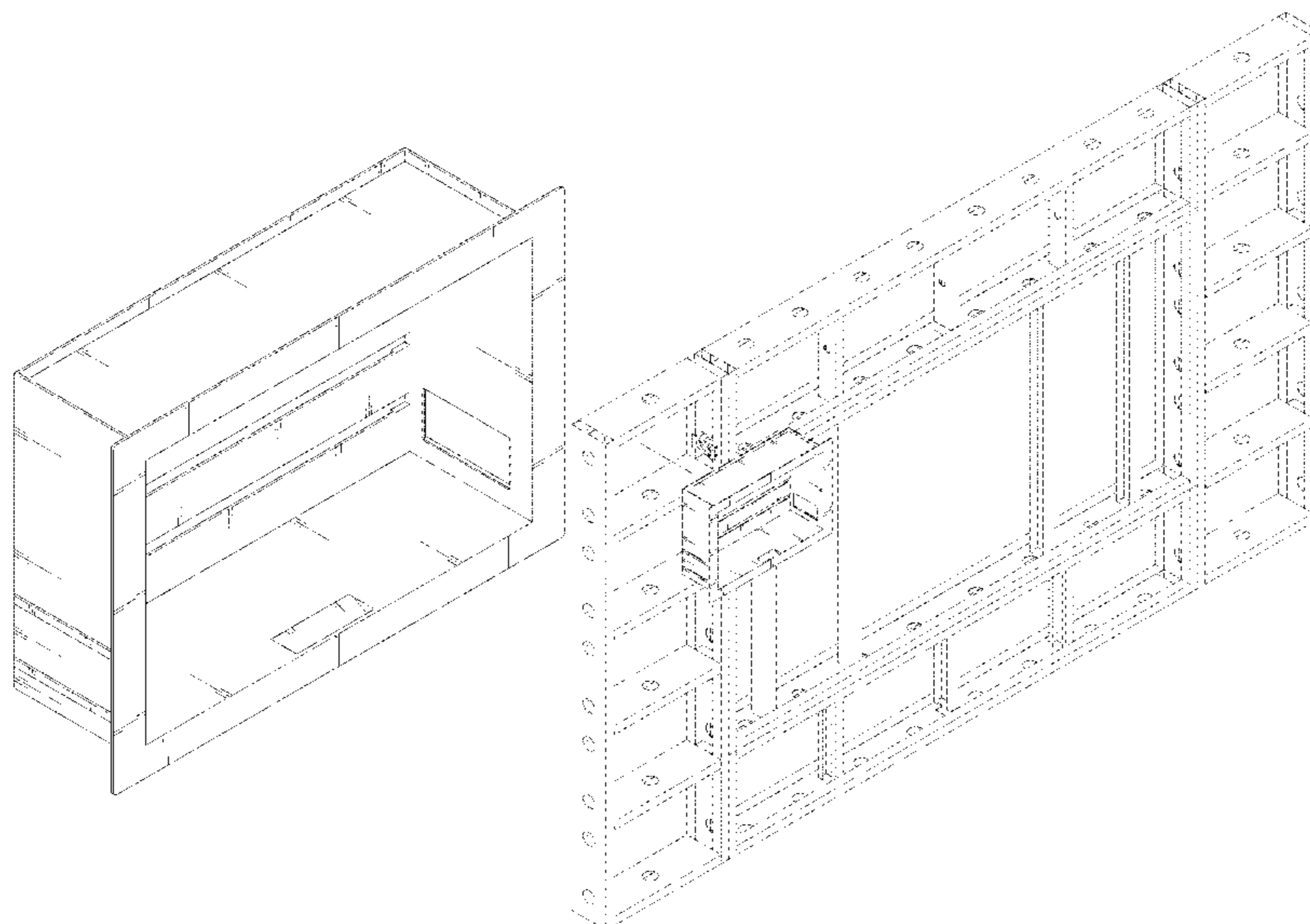

(58) **Field of Classification Search**

CPC 2203/026; H05B 1/0236; H05B 1/0275;
H05B 45/10; H05B 45/20

See application file for complete search history.

(56) **References Cited**

U.S. PATENT DOCUMENTS

D669,075 S * 10/2012 Seo D14/371
D865,723 S * 11/2019 Cho H04R 31/00
D14/225
D900,070 S * 10/2020 Lantz D14/229
D900,071 S * 10/2020 Lantz D14/229
D900,072 S * 10/2020 Lantz D14/229
10,874,028 B2 * 12/2020 Joo H04N 5/645
2020/0344910 A1 * 10/2020 Joo E04C 2/46

* cited by examiner

FIG. 1

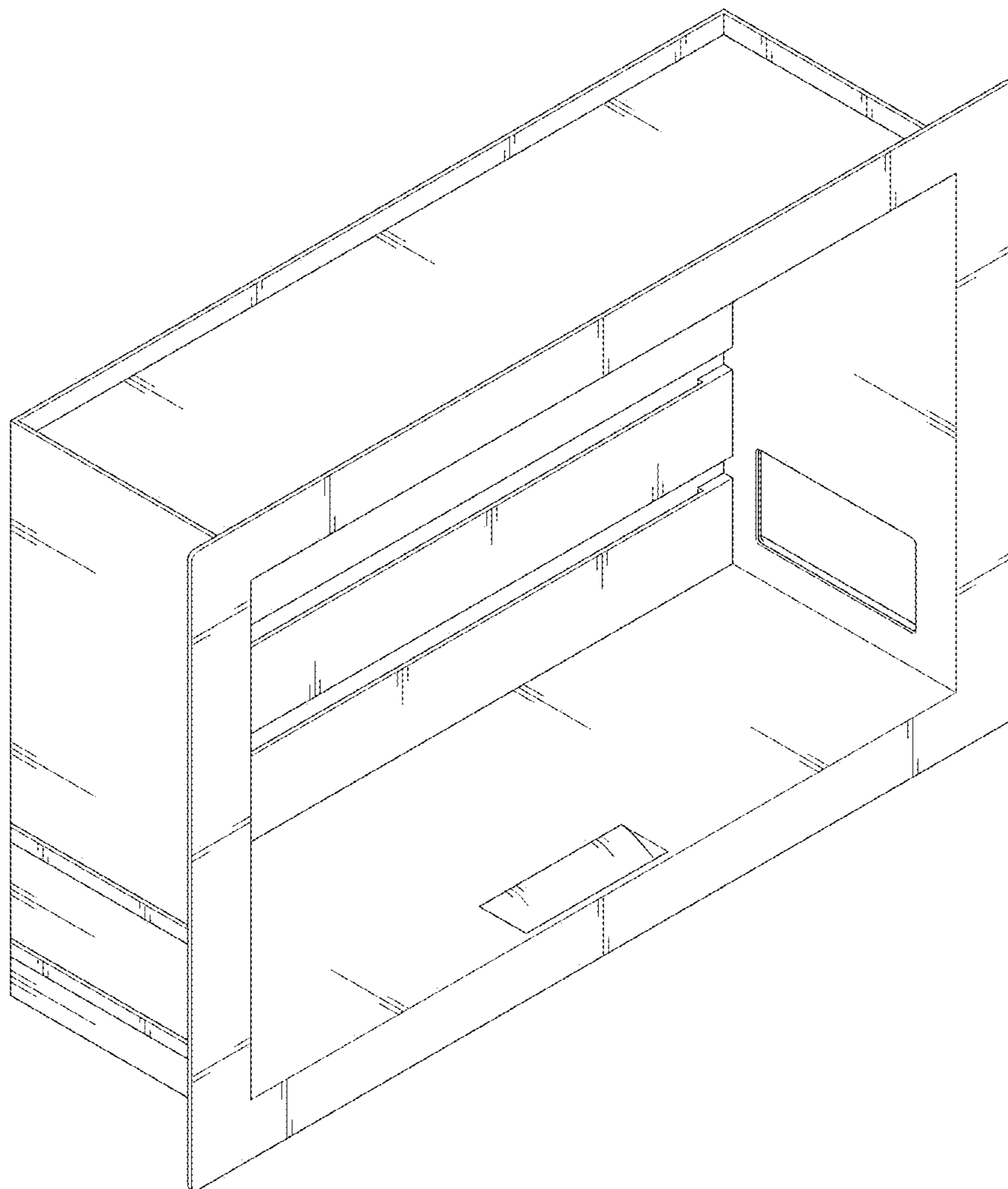

FIG. 2

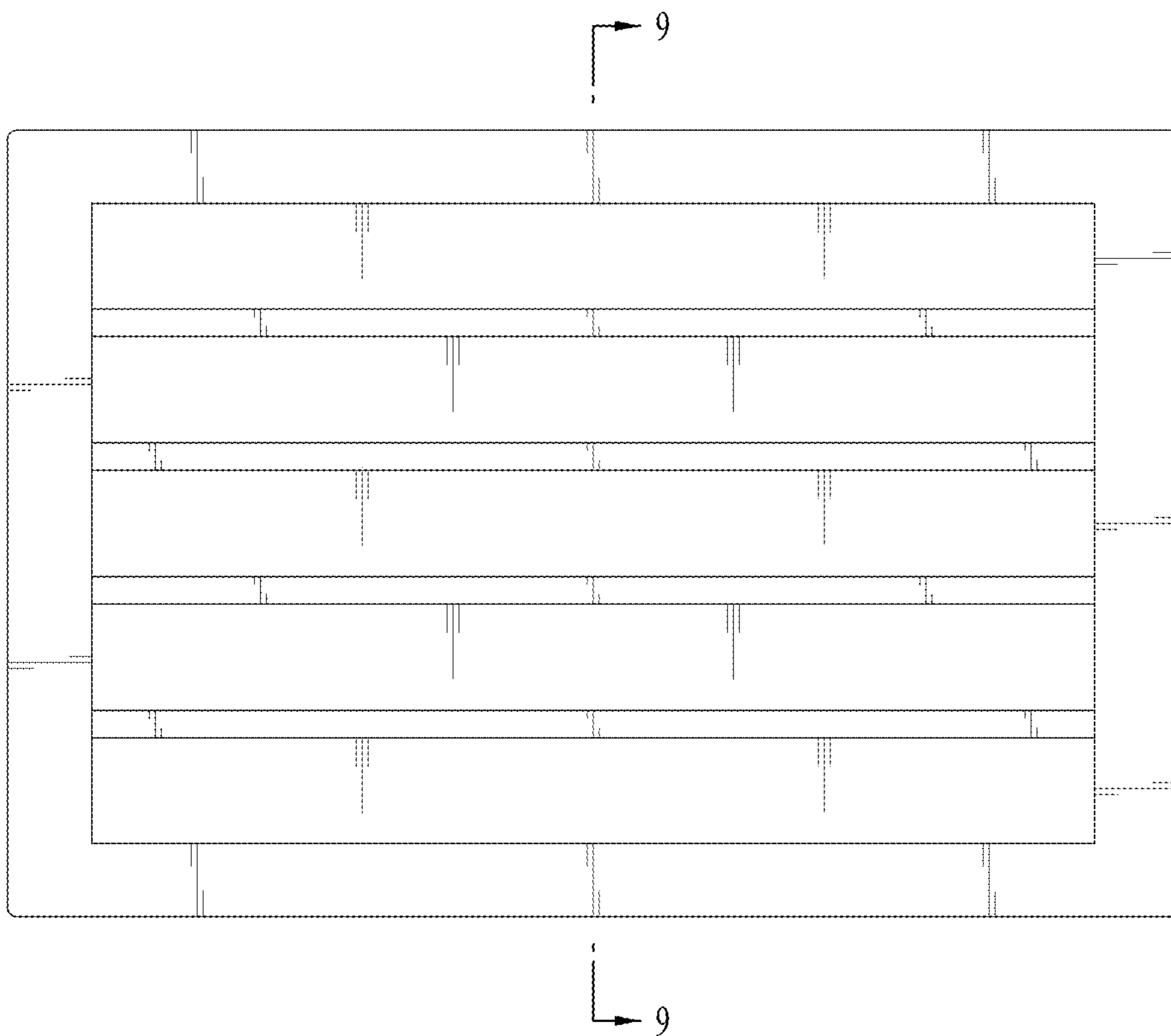

FIG. 3

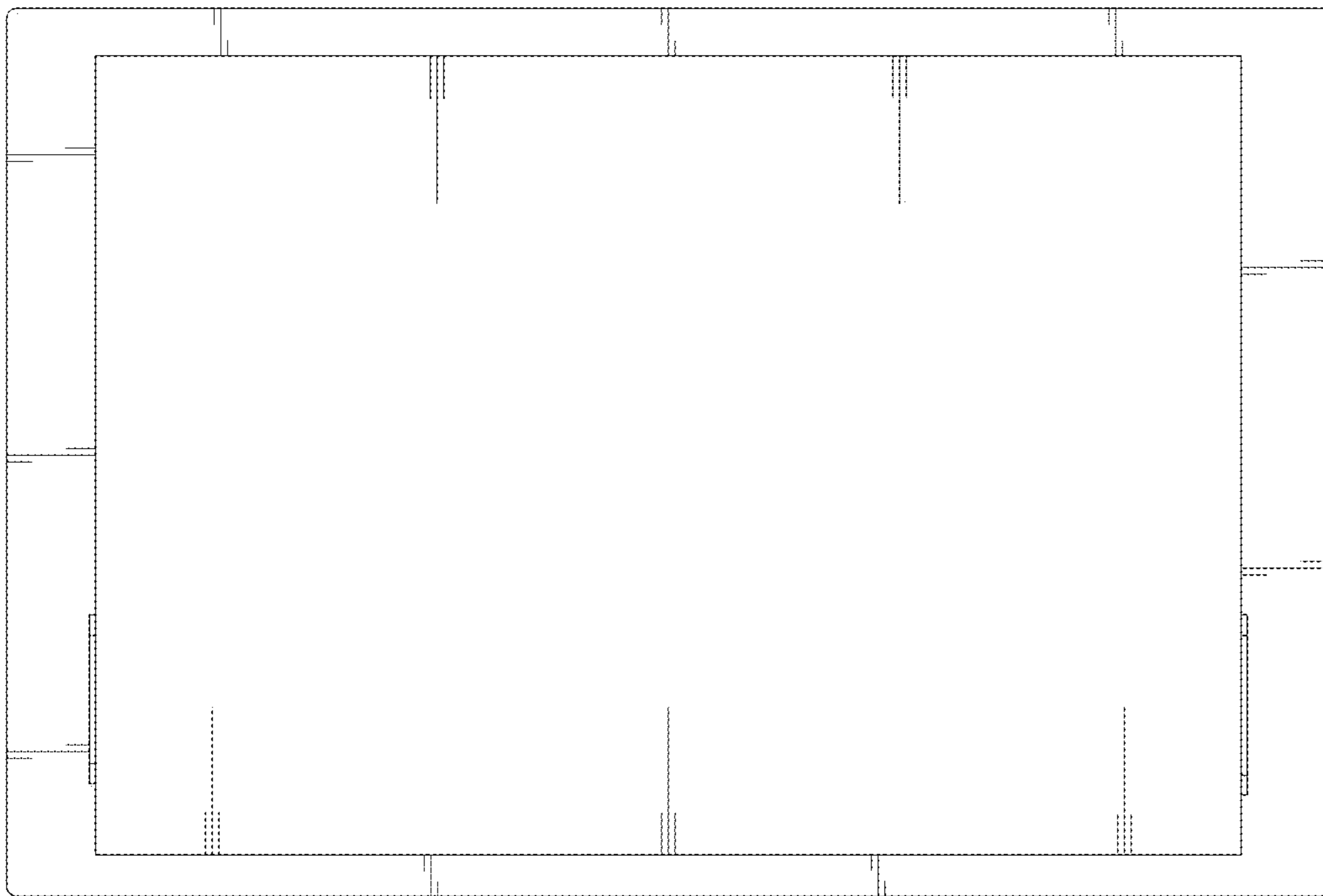

FIG. 4

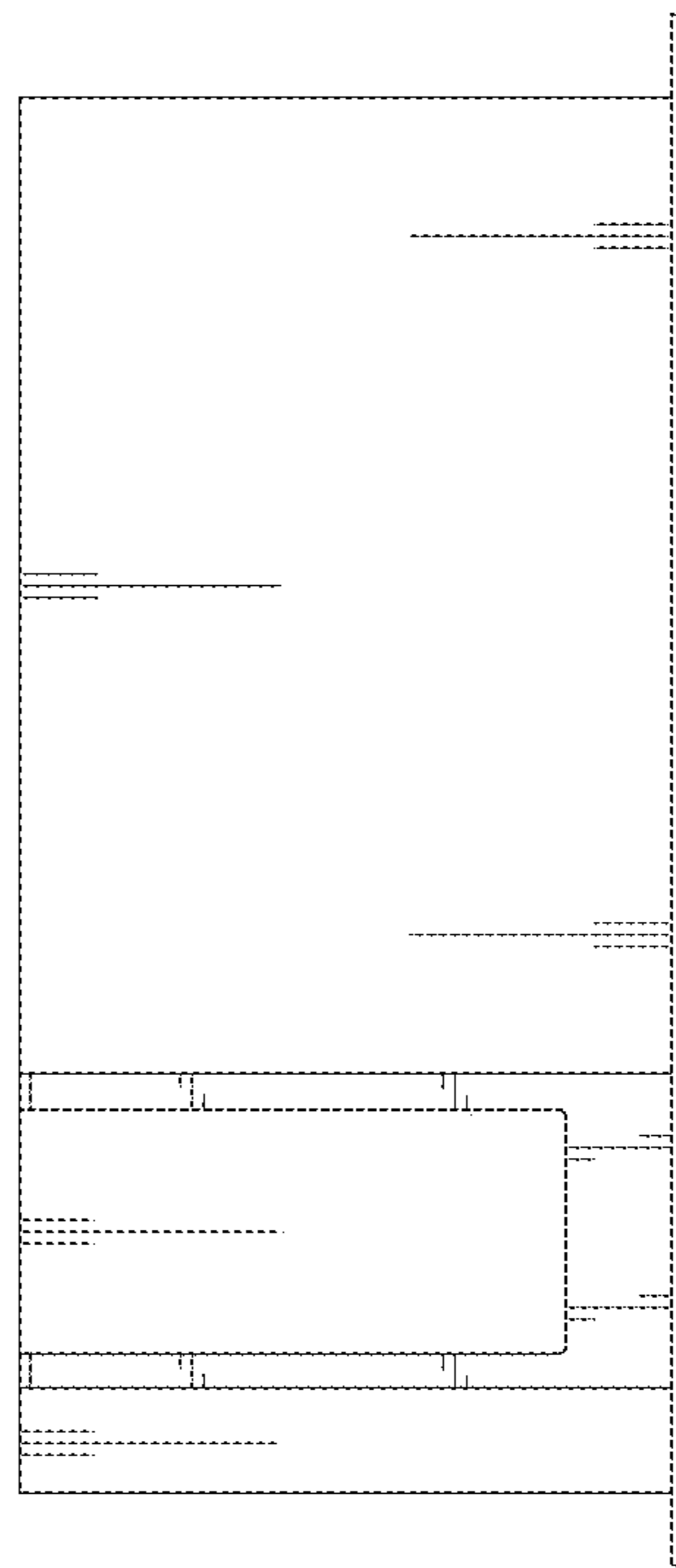

FIG. 5

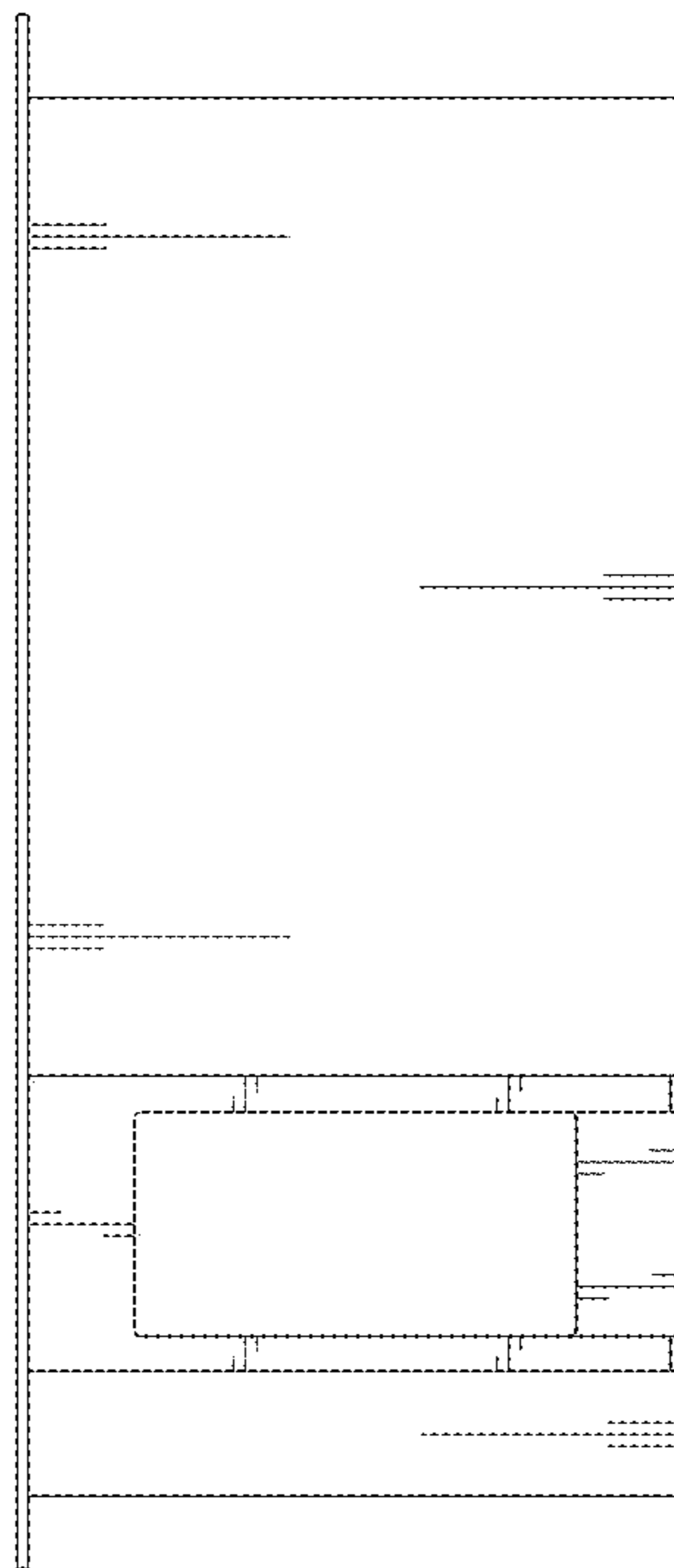

FIG. 6

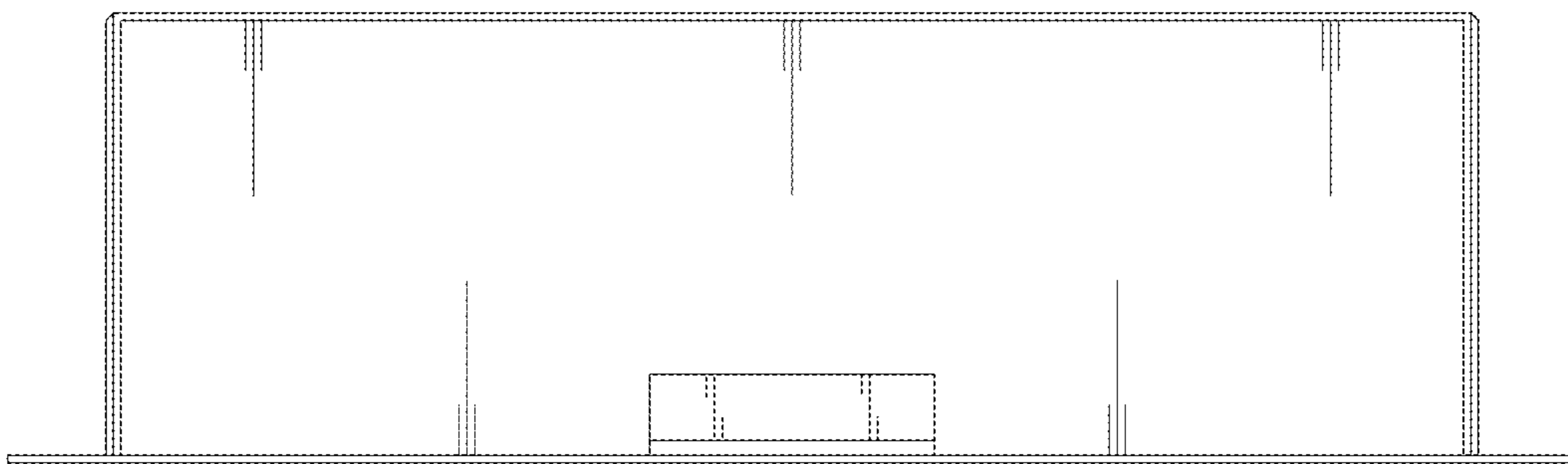

FIG. 7

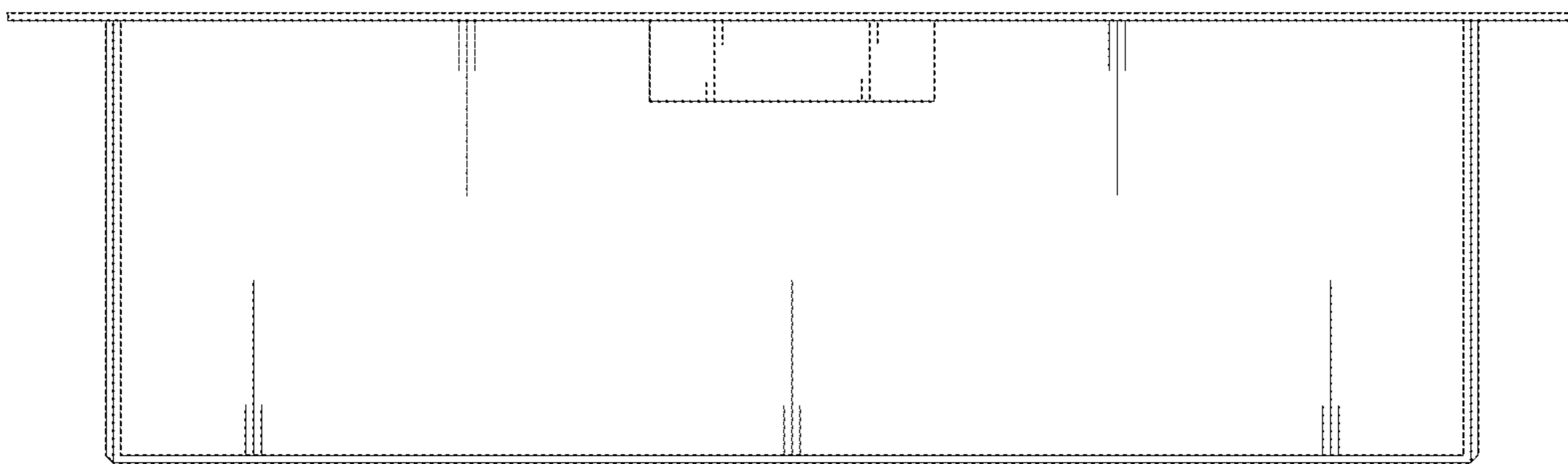

FIG. 8

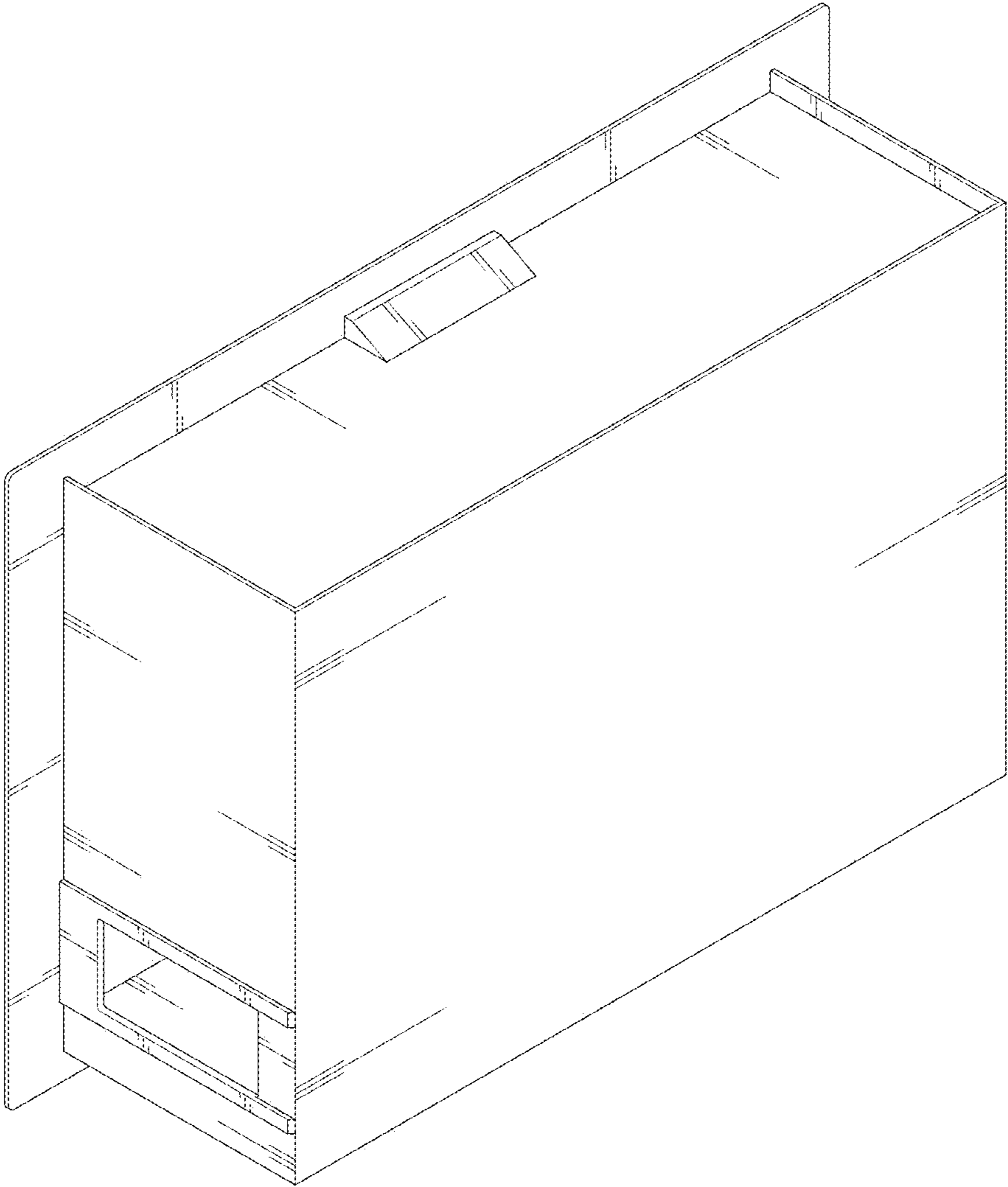

FIG. 9

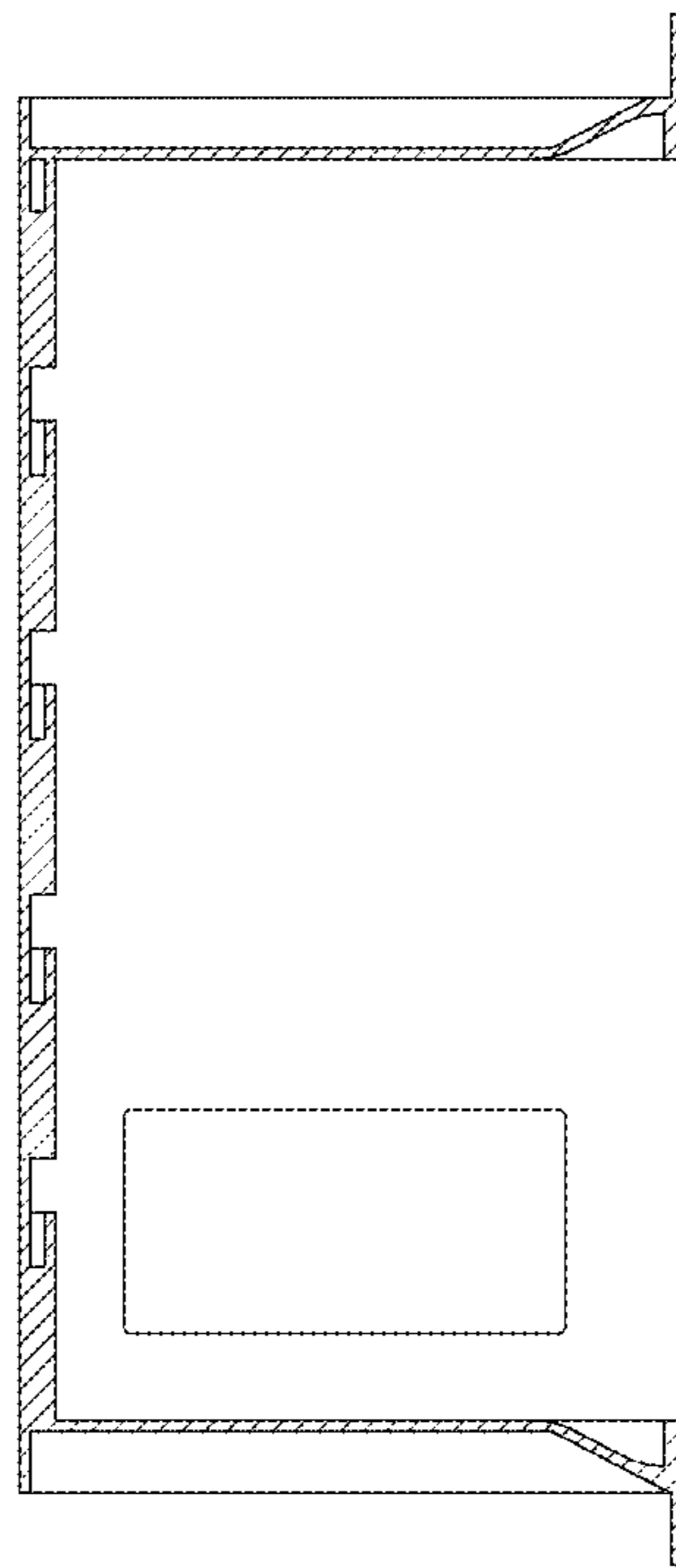

FIG. 10

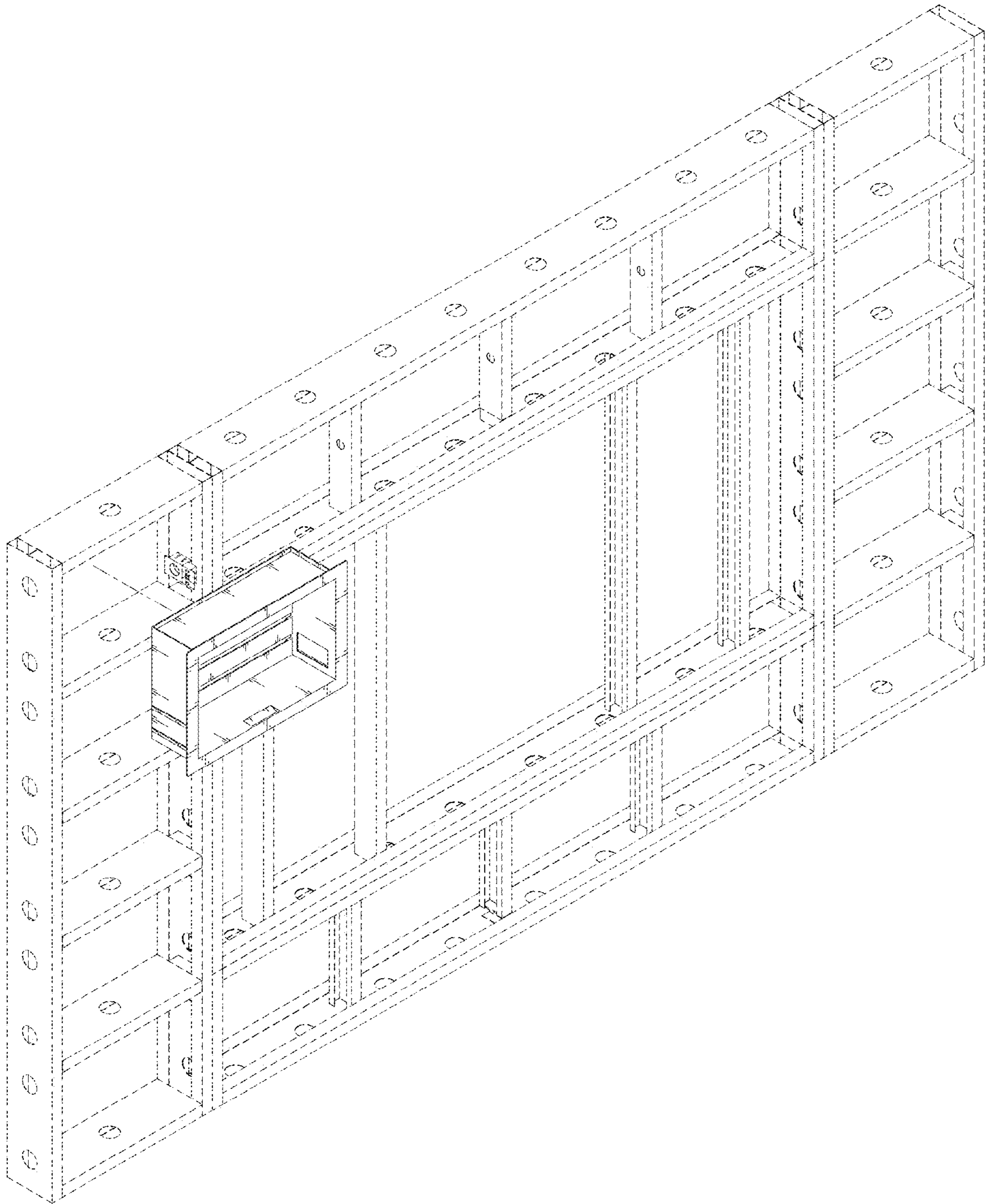

FIG. 11

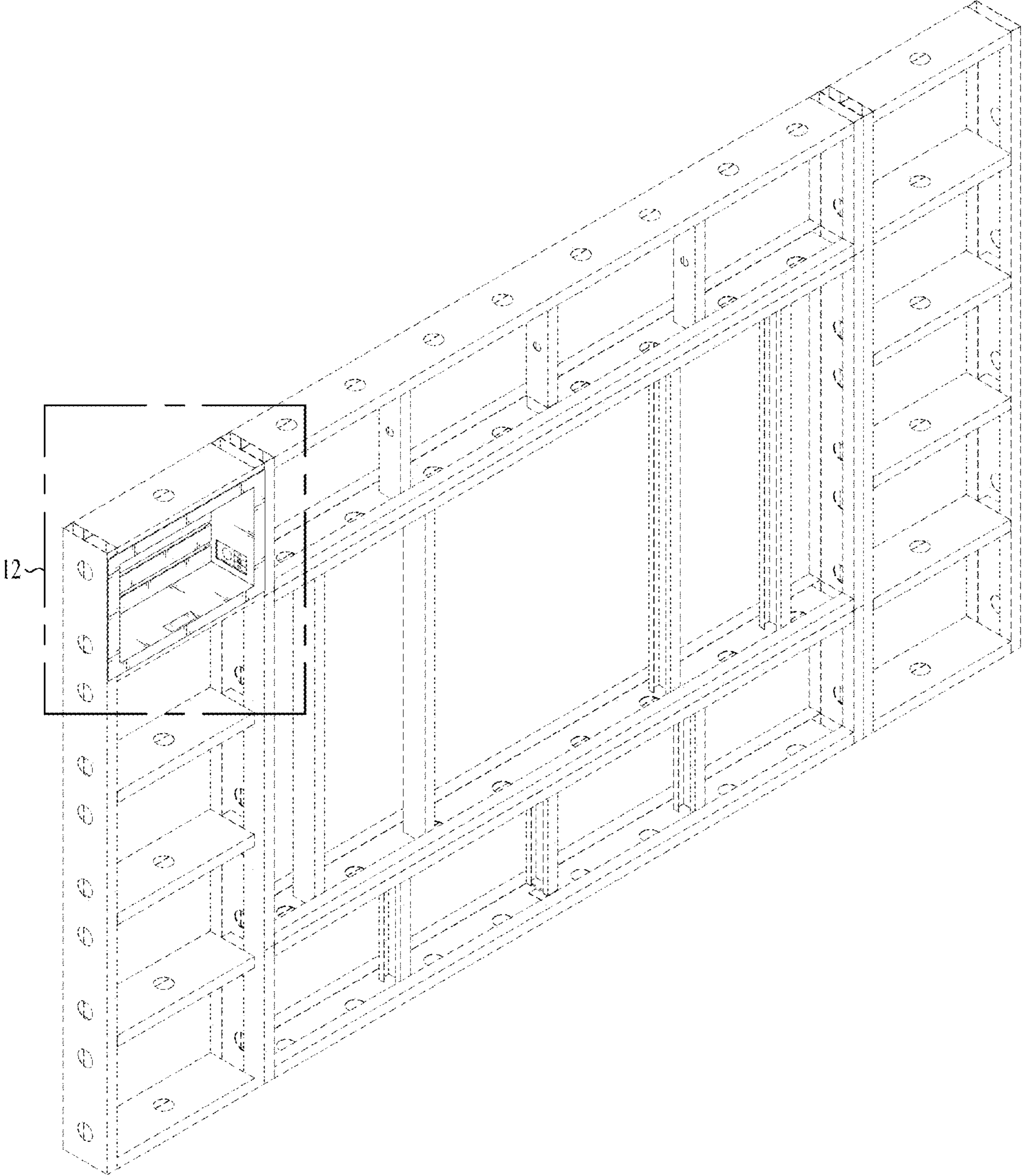

FIG. 12

