



US00D930609S

(12) **United States Design Patent** (10) **Patent No.:** **US D930,609 S**
Chen et al. (45) **Date of Patent:** **** Sep. 14, 2021**

(54) **MOBILE PHONE**

(71) Applicant: **BEIJING XIAOMI MOBILE SOFTWARE CO., LTD.**, Beijing (CN)

(72) Inventors: **Hongyu Chen**, Beijing (CN); **Long Chen**, Beijing (CN); **Xu Wei**, Beijing (CN)

(73) Assignee: **BEIJING XIAOMI MOBILE SOFTWARE CO., LTD.**, Beijing (CN)

(**) Term: **15 Years**

(21) Appl. No.: **35/509,550**

(22) Filed: **Dec. 5, 2019**

(80) **Hague Agreement Data**

Int. Filing Date: **Dec. 5, 2019**

Int. Reg. No.: **DM/206107**

Int. Reg. Date: **Dec. 5, 2019**

Int. Reg. Pub. Date: **Jun. 5, 2020**

(30) **Foreign Application Priority Data**

Jun. 12, 2019 (CN) 201930302292.8

(51) **LOC (13) Cl.** **14-03**

(52) **U.S. Cl.**
USPC **D14/138 AB**

(58) **Field of Classification Search**

USPC D3/201, 212, 218, 226, 227, 247, 249,
D3/250, 269, 303; D13/103, 107, 108,
(Continued)

(56) **References Cited**

U.S. PATENT DOCUMENTS

D681,000 S * 4/2013 Koh D14/203.4
D681,054 S * 4/2013 Koh D14/496
(Continued)

OTHER PUBLICATIONS

Oppo Folding Phone adds a Pop Up Camera, publication date Feb. 26, 2019, [online][site visited Apr. 16, 2021] URL: <https://www.concept-phones.com/cool-concepts/oppo-folding-phone-adds-a-pop-up-camera-looks-like-a-whiskey-flask/> (Year: 2019).*

concept-phones.com/cool-concepts/oppo-folding-phone-adds-a-pop-up-camera-looks-like-a-whiskey-flask/ (Year: 2019).*

(Continued)

Primary Examiner — L. A. Grabenstetter

(74) *Attorney, Agent, or Firm* — Syncoda LLC; Feng Ma

(57) **CLAIM**

The ornamental design for a mobile phone, as shown and described.

DESCRIPTION

1. Mobile phone

1.1 : Front view shown in a folded state with the integral camera retracted

1.2 : Back view thereof

1.3 : Left view thereof

1.4 : Right view thereof

1.5 : Top view thereof

1.6 : Bottom view thereof

1.7 : Front perspective view thereof

1.8 : Back perspective view thereof

1.9 : Front view shown in a folded state with the integral camera extended

1.10 : Back view thereof

1.11 : Left view thereof

1.12 : Right view thereof

1.13 : Top view thereof

1.14 : Bottom view thereof

1.15 : Front perspective view shown in an unfolded state with the integral camera retracted

1.16 : Back perspective view shown in an unfolded state with the integral camera retracted

1.17 : Front view shown in an unfolded condition with the integral camera extended

1.18 : Back view thereof

1.19 : Left view thereof

1.20 : Right view thereof

1.21 : Top view thereof

1.22 : Bottom view thereof

1 Claim, 22 Drawing Sheets

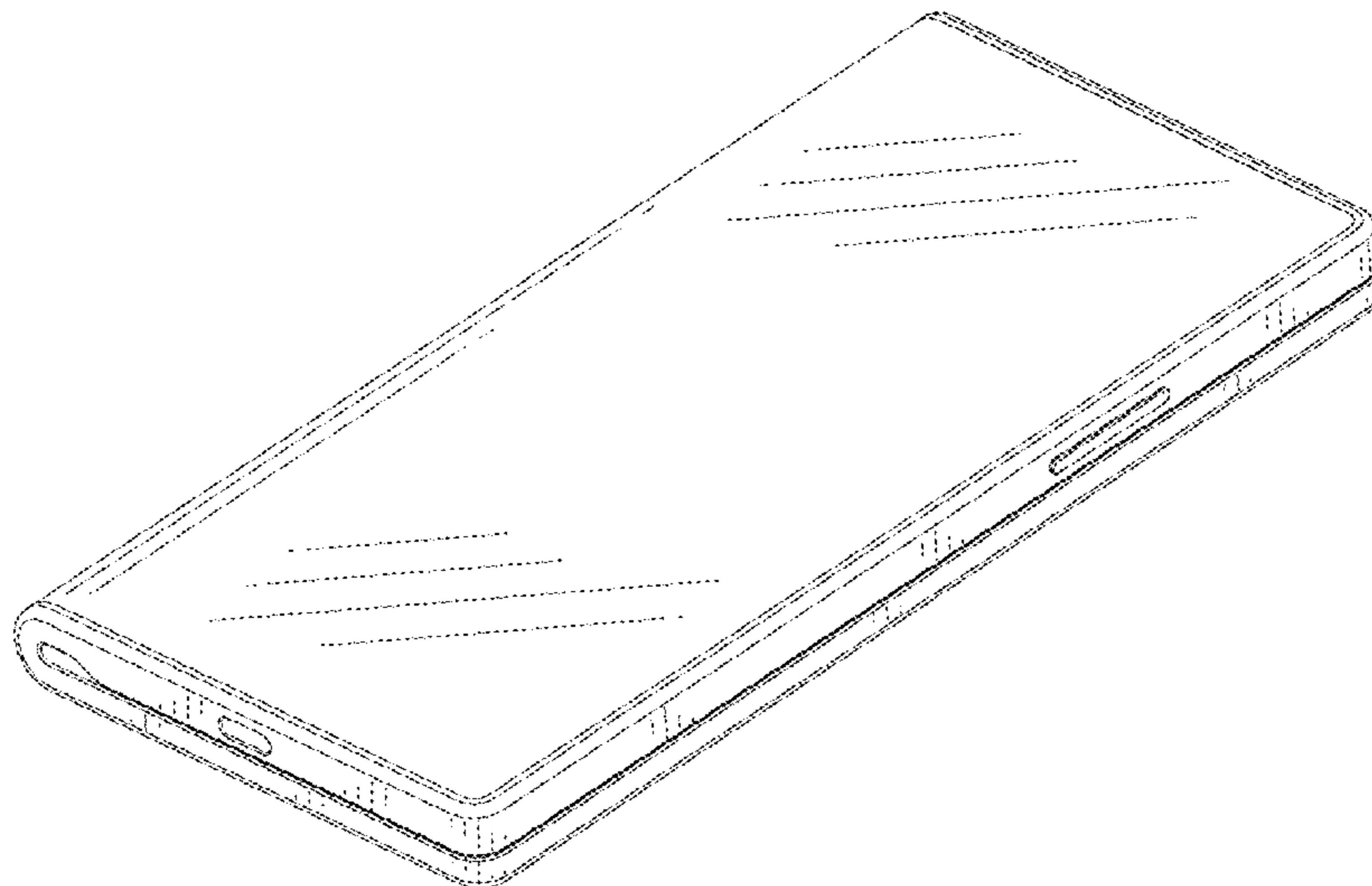

(58) **Field of Classification Search**

USPC D13/119; D14/137, 138 R, 138 AA,
 D14/138 C, 138 G, 172, 192,
 D14/203.3–203.7, 217, 238.1, 247, 248,
 D14/250–253, 345, 434, 440, 447, 496,
 D14/138 AB; D21/332
 CPC H04B 1/3888; H04M 1/0283; H04M
 1/0202; A45C 1/06; A45C 2011/002;
 A45C 11/00; A45F 2005/028; A45F
 2200/0525

See application file for complete search history.

(56) **References Cited**

U.S. PATENT DOCUMENTS

D745,001	S	*	12/2015	Cho	D14/341
D749,571	S	*	2/2016	Park	D14/345
D758,364	S	*	6/2016	Ahn	D14/345
D779,481	S	*	2/2017	Jun	D14/341
D781,854	S	*	3/2017	Park	D14/345
D791,725	S	*	7/2017	Lee	D14/138 AB
9,762,781	B2	*	9/2017	Evans, V	H04N 5/2254
D828,319	S	*	9/2018	Seo	D14/138 AB
D841,646	S	*	2/2019	Son	D14/345
D847,134	S	*	4/2019	Yamazaki	D14/345

D848,416	S	*	5/2019	Yamazaki	D14/345
D886,758	S	*	6/2020	Wang	D14/138 C
D888,700	S	*	6/2020	Huang	D14/248
D888,711	S	*	6/2020	Okuley	D14/345
2012/0044620	A1	*	2/2012	Song	G06F 1/1681 361/679.01
2014/0218321	A1	*	8/2014	Lee	G06F 1/1643 345/173
2017/0357289	A1	*	12/2017	Ahn	G06F 1/1652
2018/0262663	A1	*	9/2018	Zhang	H04M 1/0264

OTHER PUBLICATIONS

10 Best Phones With Motorized or Pop-Up Cameras, publication date Jun. 27, 2019, [online][site visited Apr. 16, 2021] URL: <https://pandaily.com/10-best-phones-with-motorized-or-pop-up-cameras/> (Year: 2019).*

TCL's folding phone prototypes leaked, publication date Feb. 23, 2019, [online] URL: <https://liliputing.com/2019/02/tcls-folding-phone-prototypes-leaked-a-little-early.html> (Year: 2019).*

Xiaomi foldable phone with pop-up penta camera system shown off, publication date Nov. 11, 2019, [online] URL: <https://androidcommunity.com/xiaomi-foldable-phone-with-pop-up-penta-camera-system-shown-off-20191111/> (Year: 2019).*

* cited by examiner

1.1

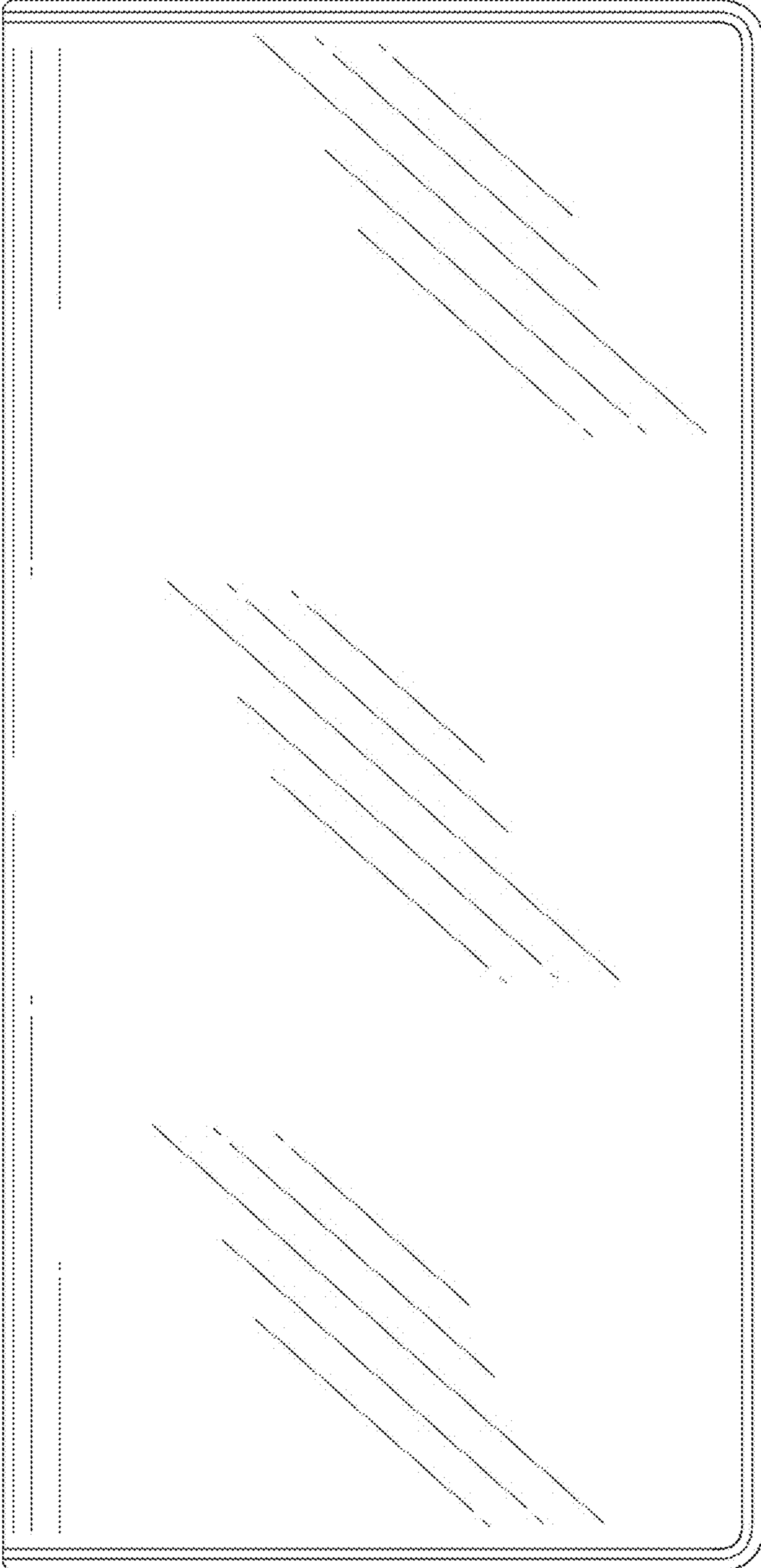

1.2

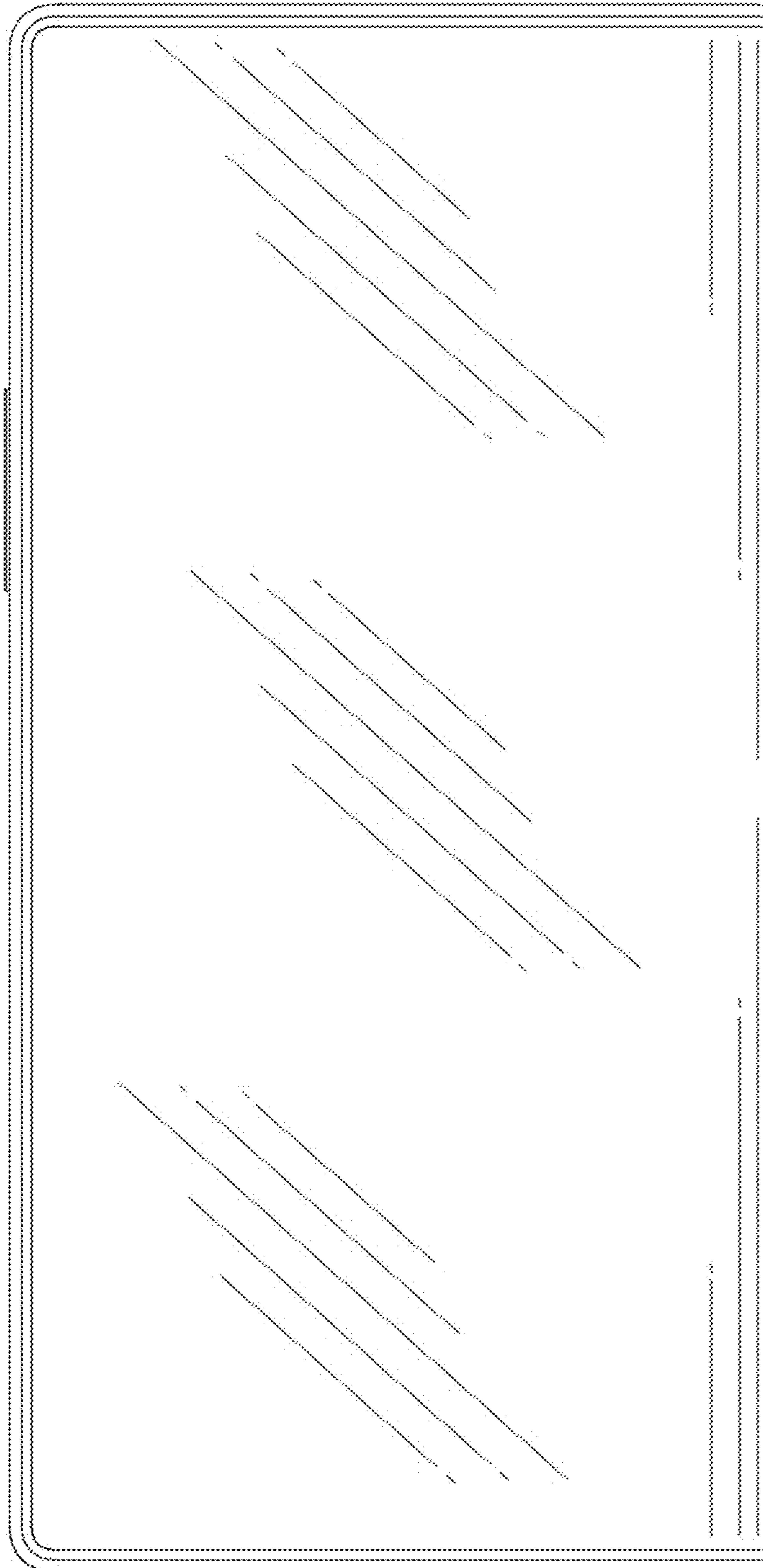

1.3

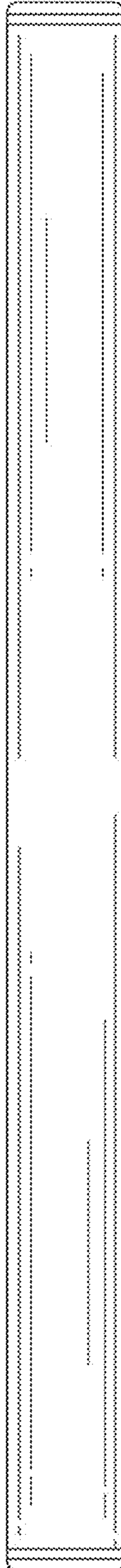

1.4

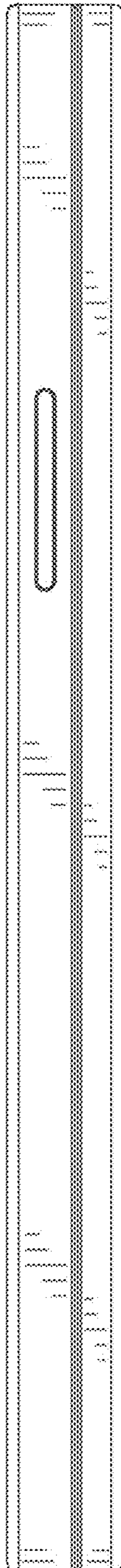

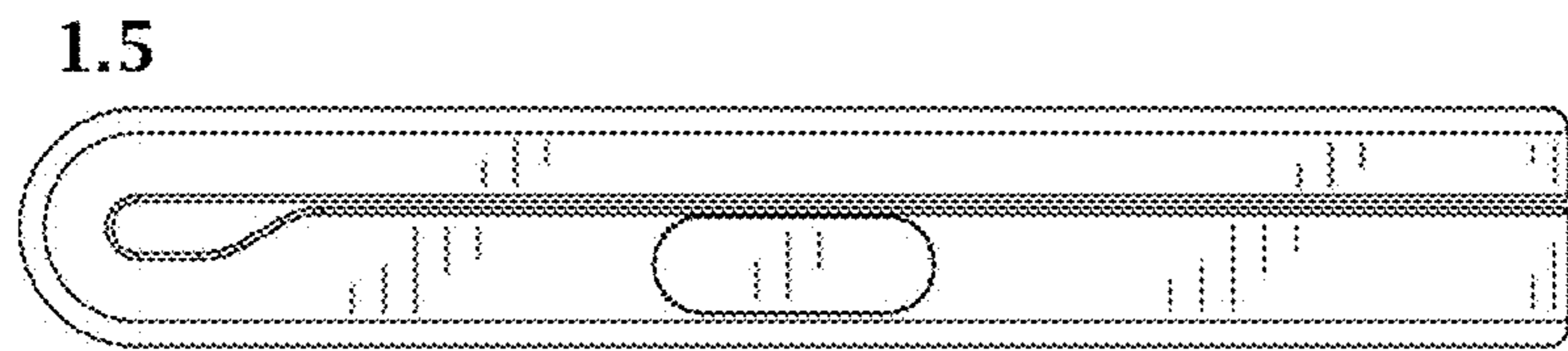

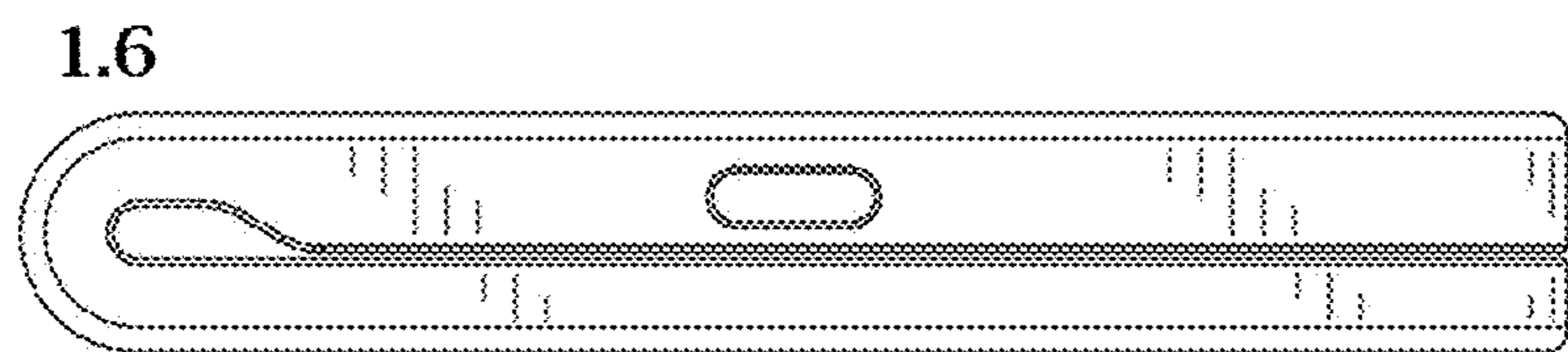

1.7

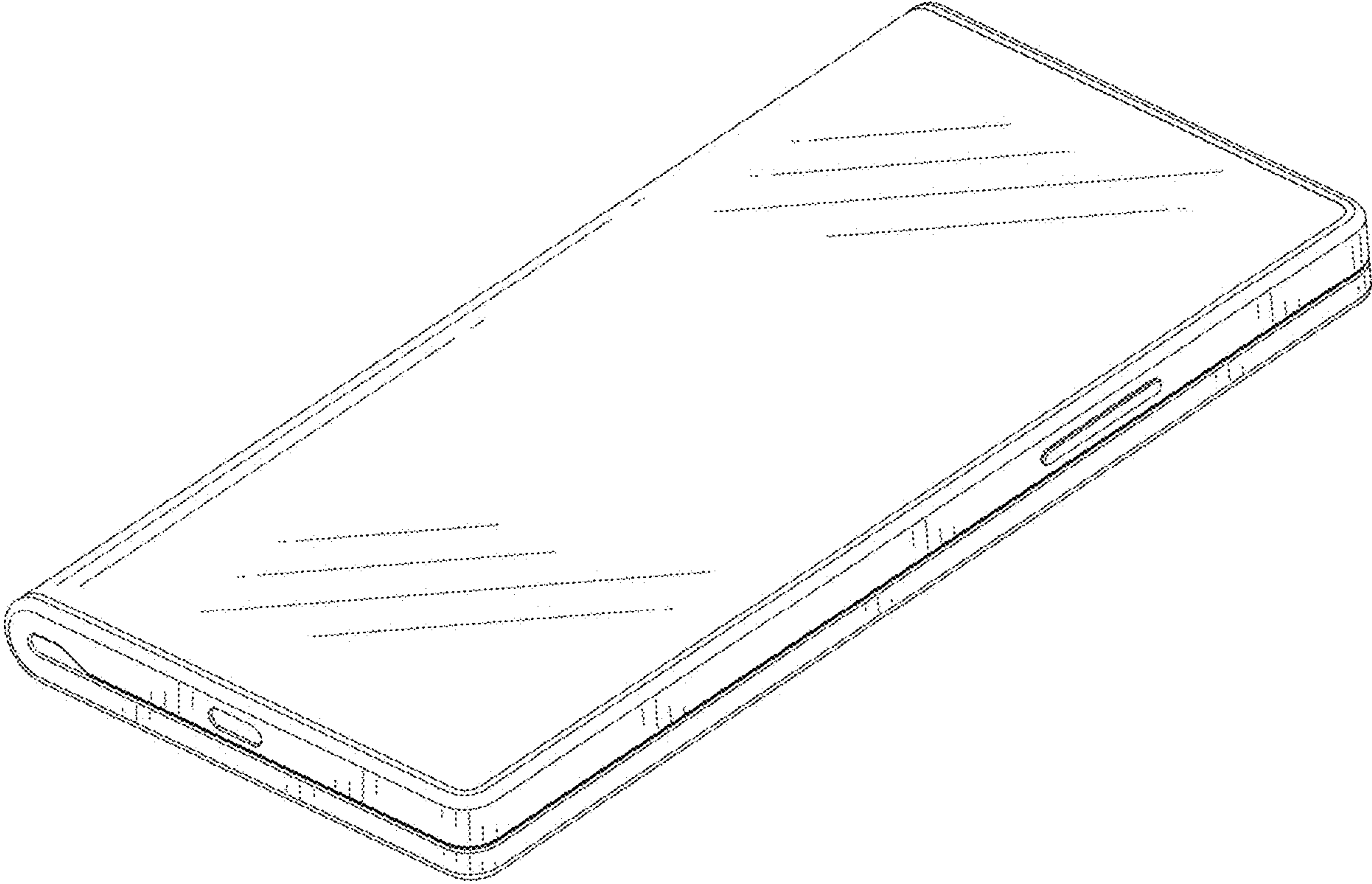

1.8

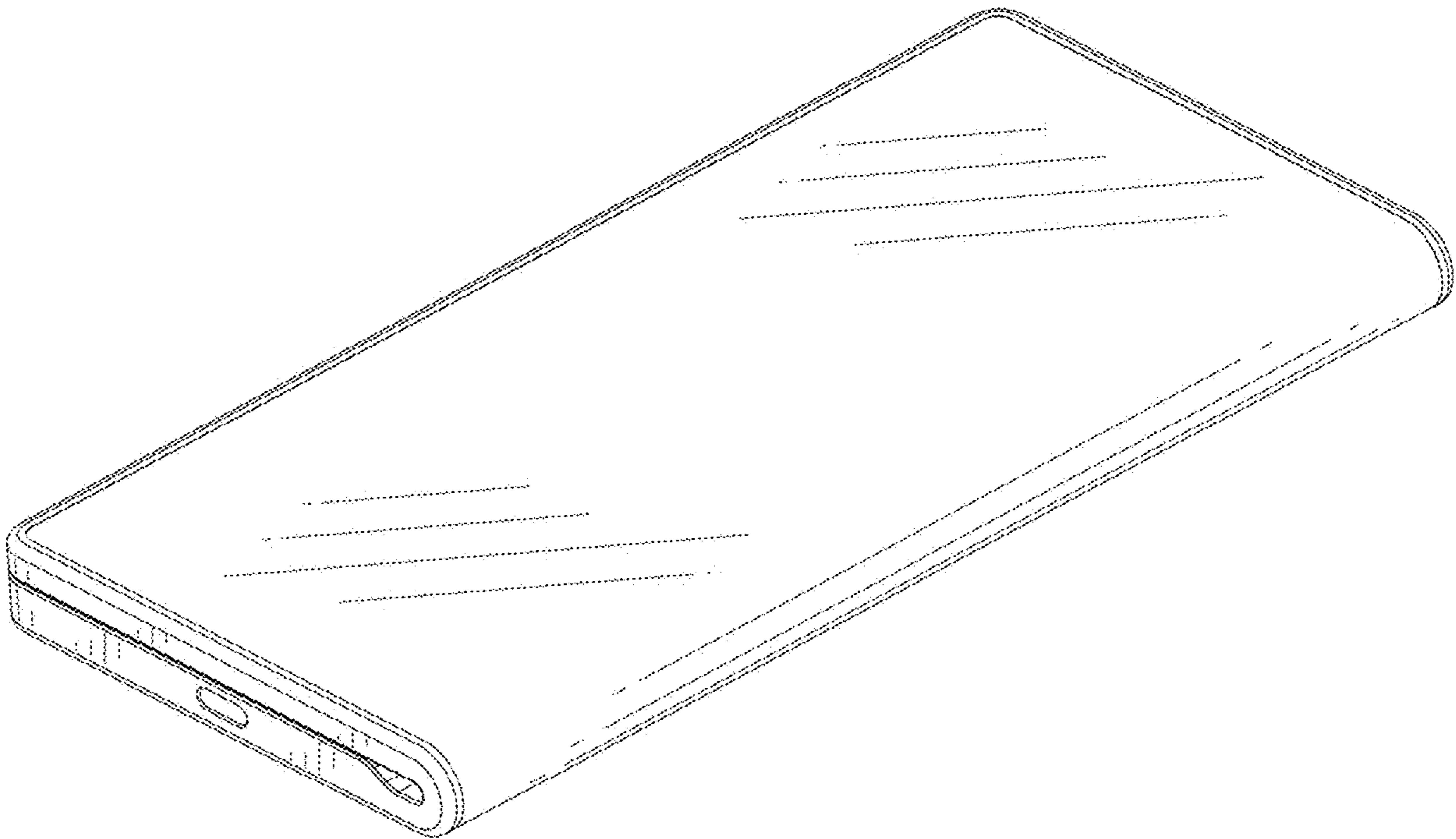

1.9

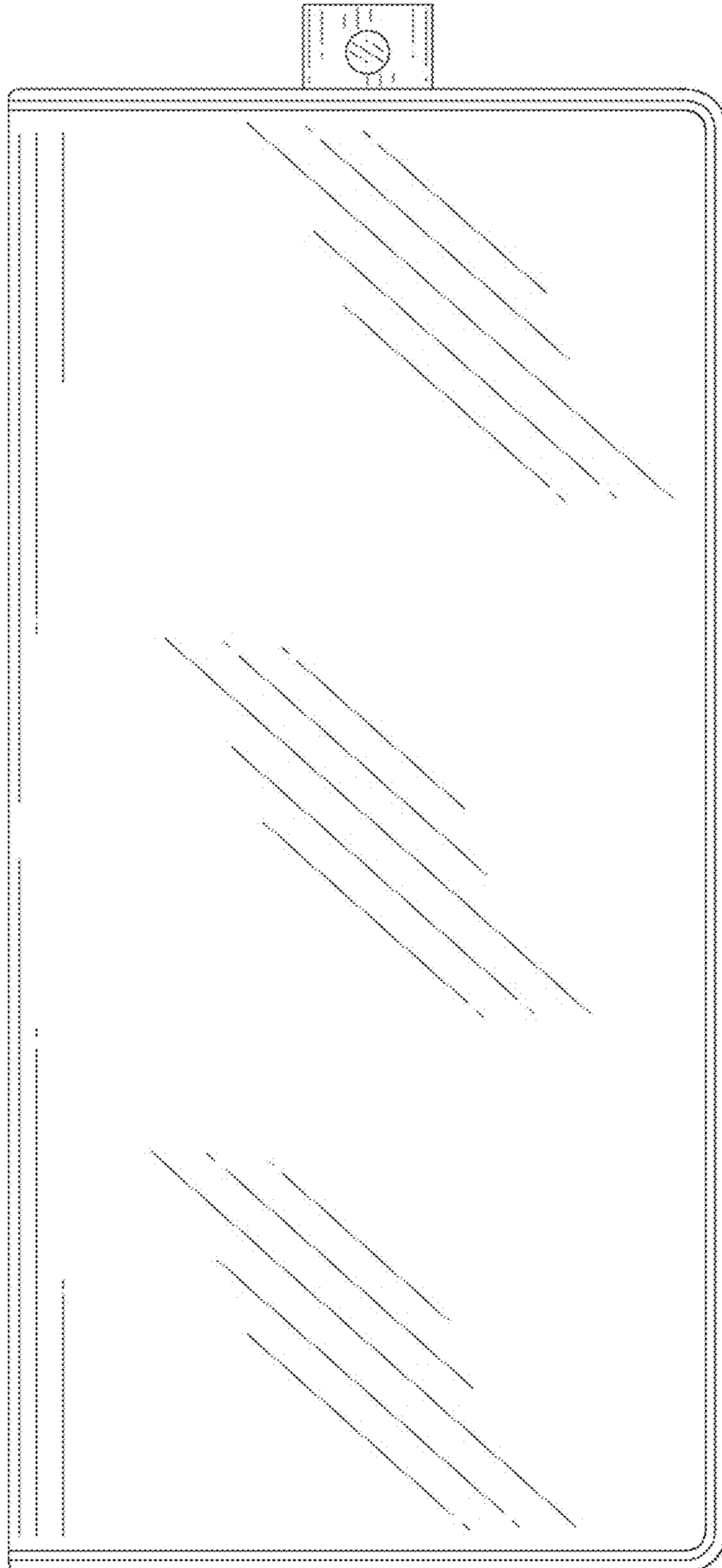

1.10

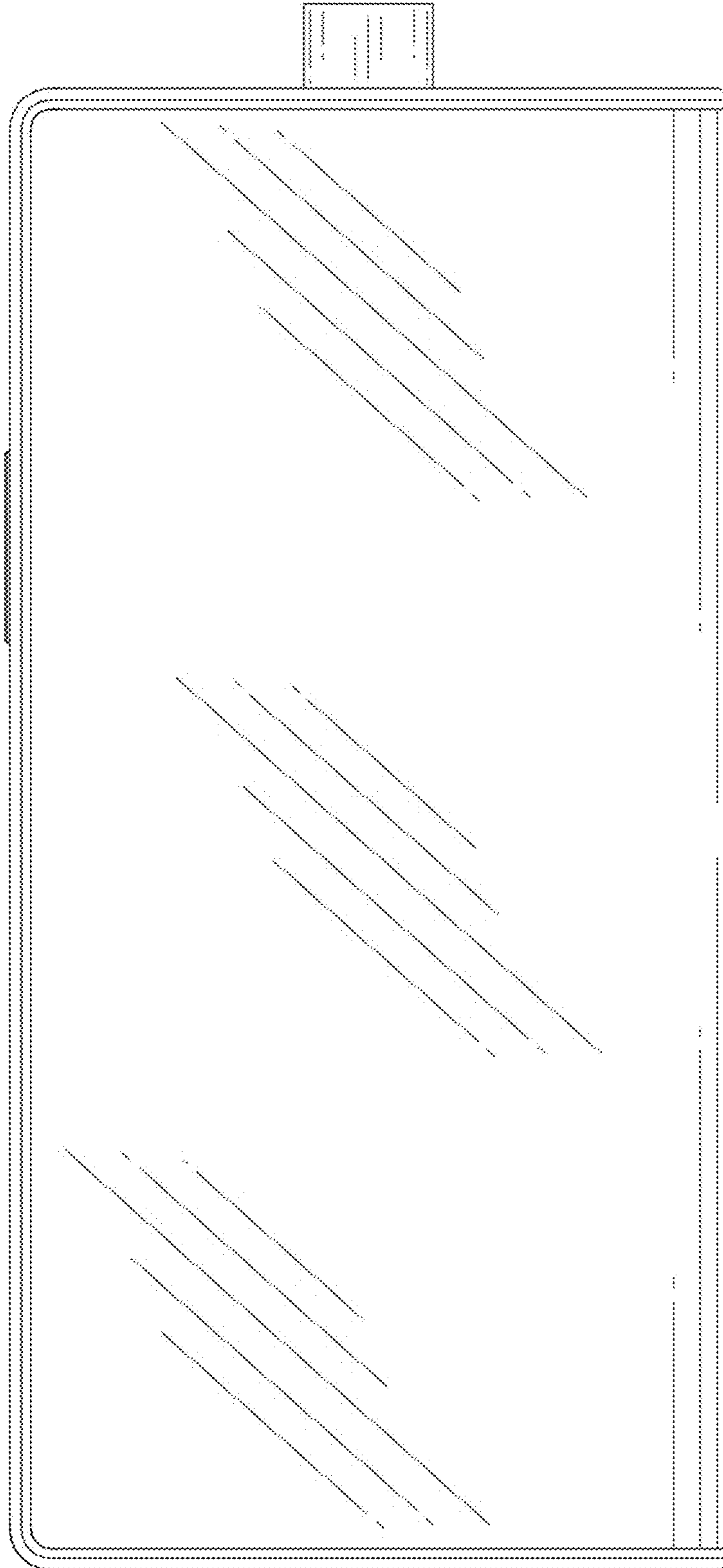

1.11

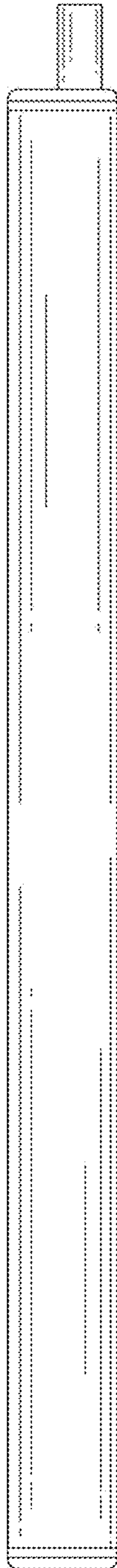

1.12

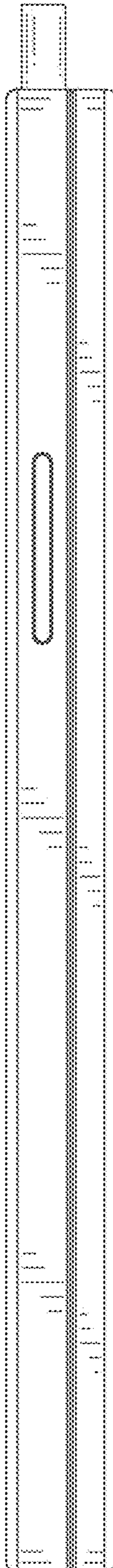

1.13

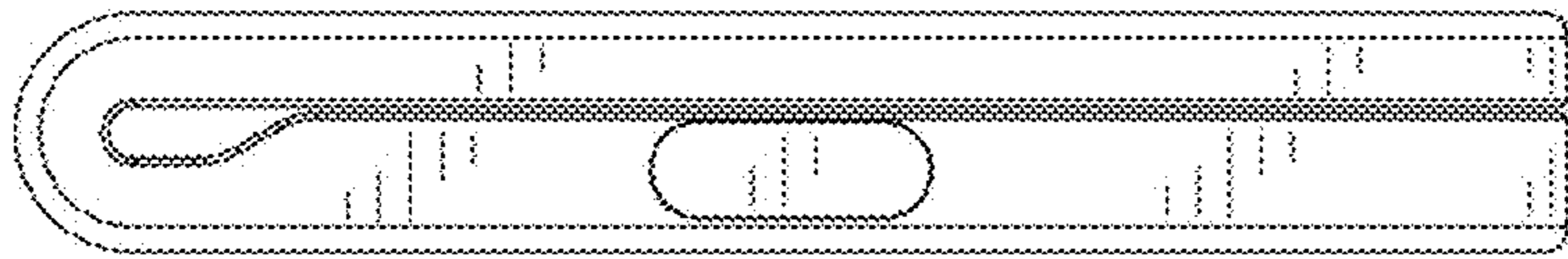

1.14

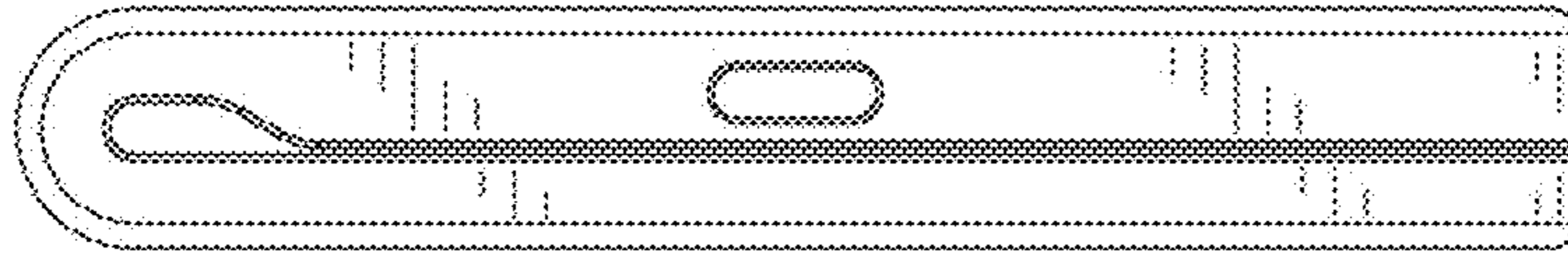

1.15

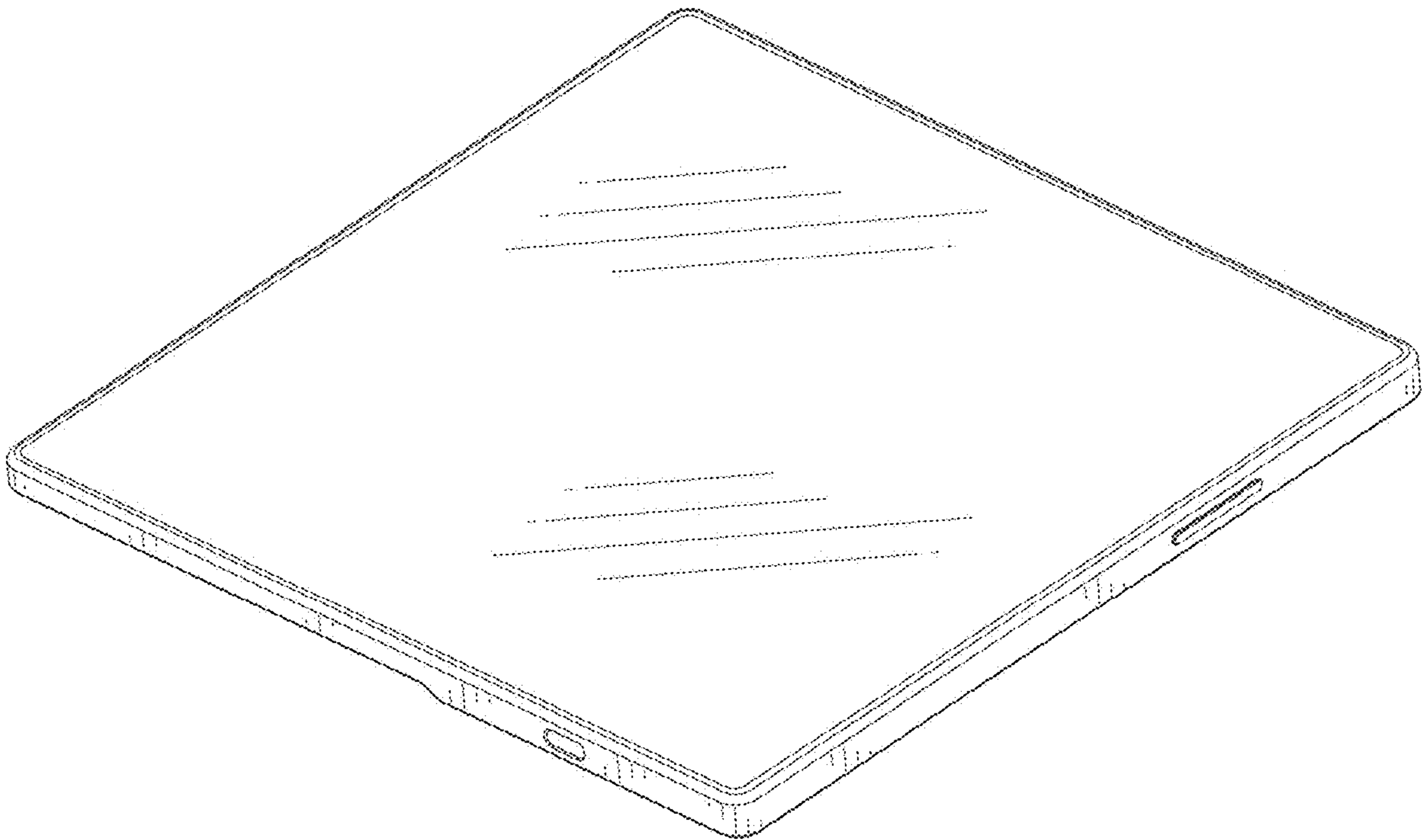

1.16

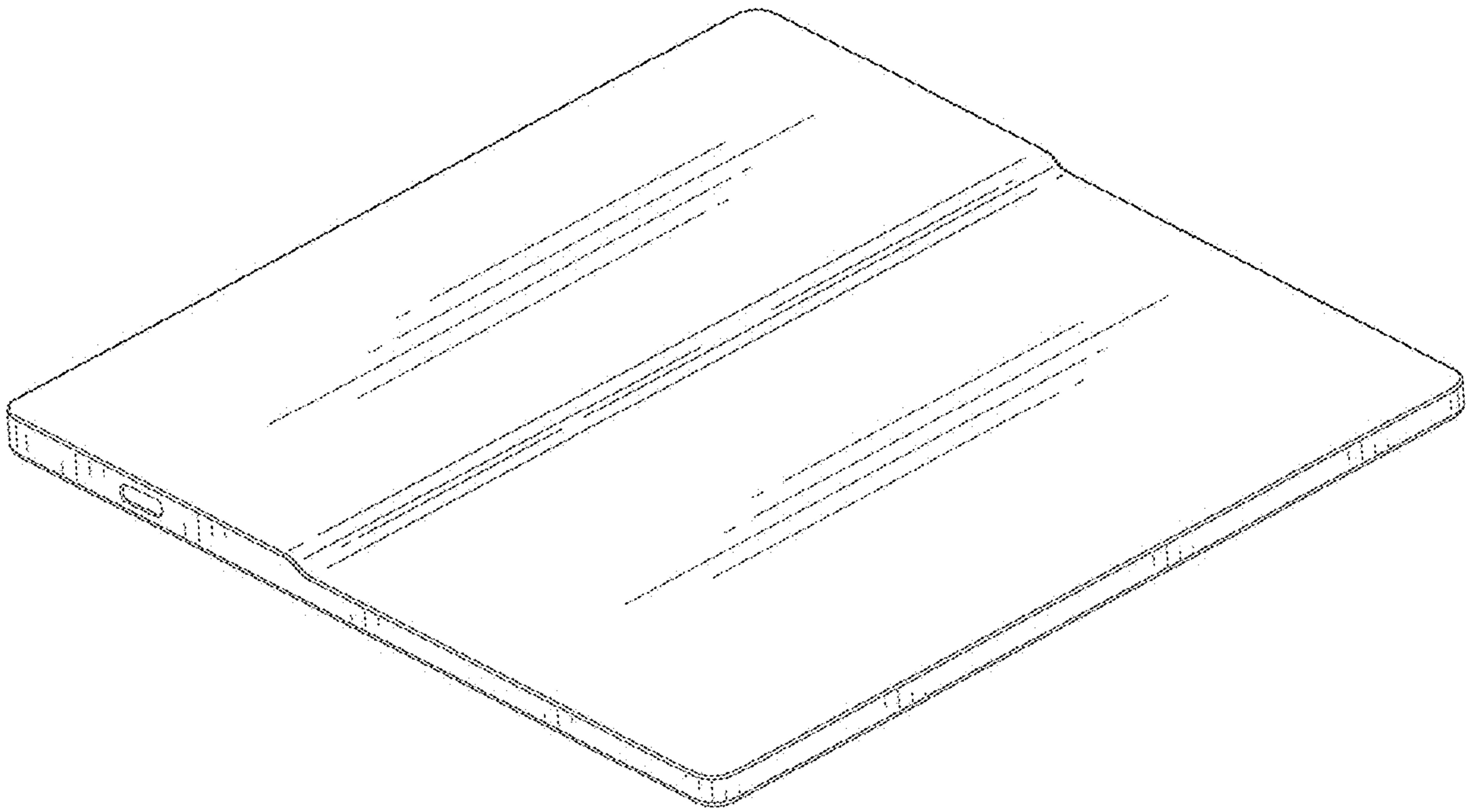

1.17

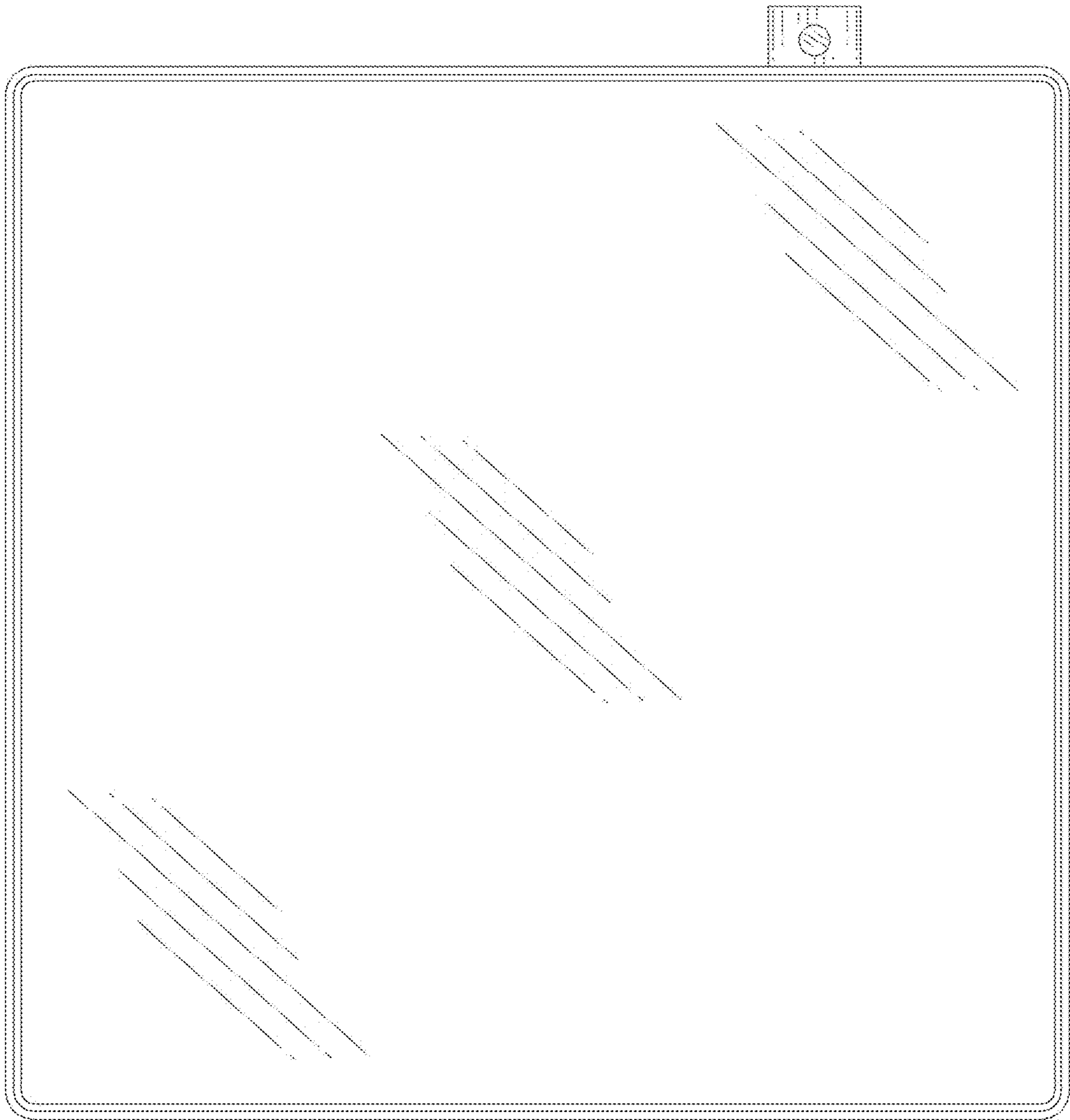

1.18

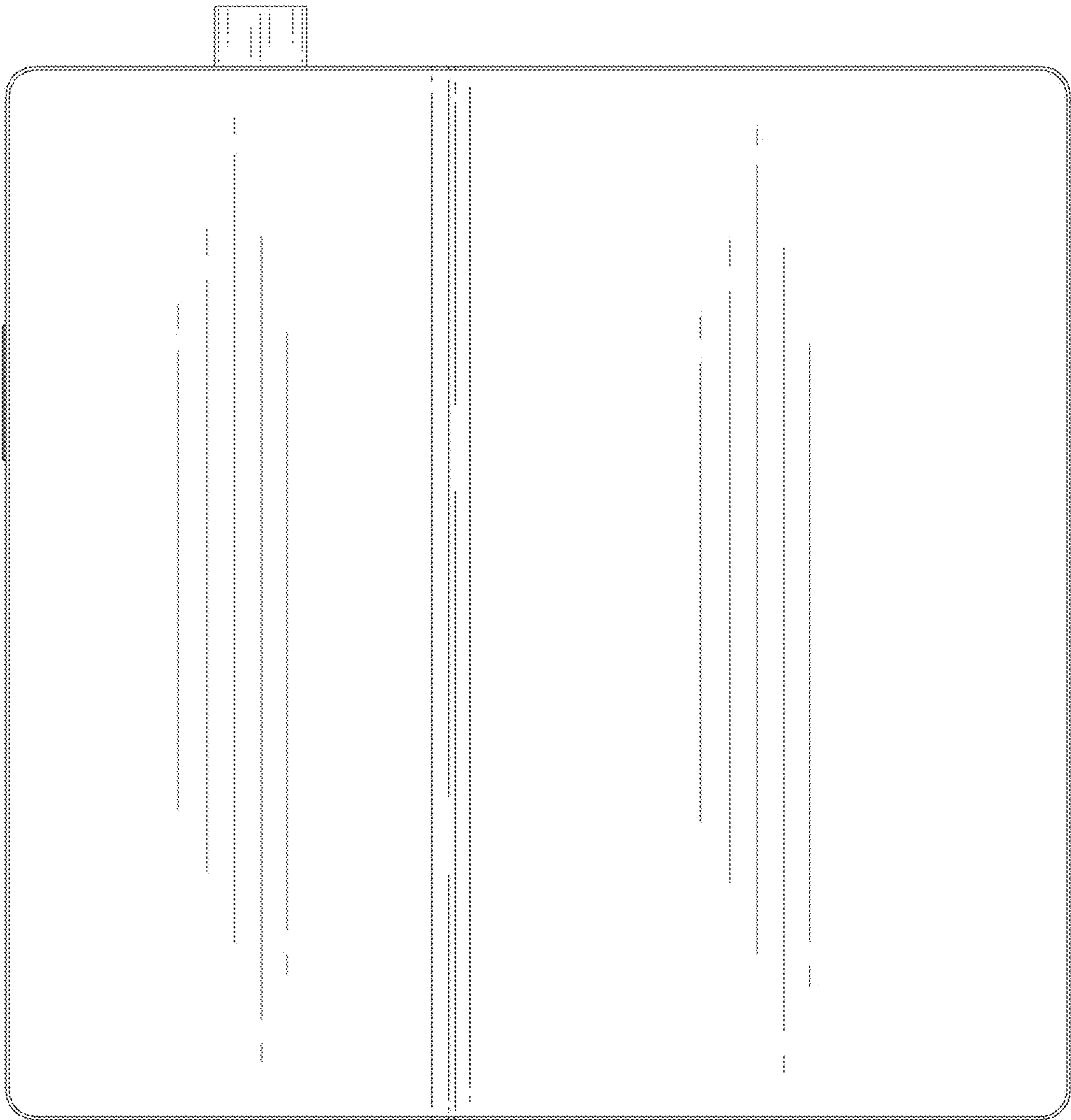

1.19



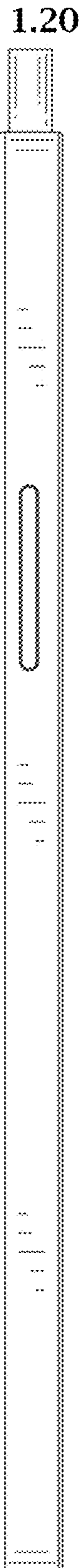

1.21

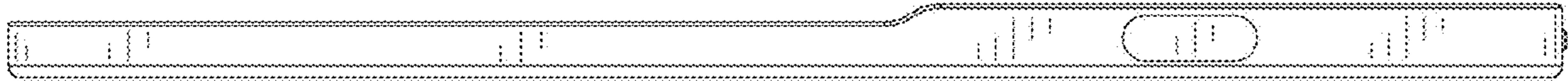

1.22

