



US00D930597S

(12) **United States Design Patent** (10) **Patent No.:** **US D930,597 S**  
**C et al.** (45) **Date of Patent:** **\*\* Sep. 14, 2021**

(54) **CONNECTOR SHROUD**

(74) *Attorney, Agent, or Firm* — Banner & Witcoff, Ltd.

(71) Applicant: **Molex, LLC**, Lisle, IL (US)

(57) **CLAIM**

(72) Inventors: **Krishnamurthy C**, Bangalore (IN);  
**Harsha Thyagaraj**, Bangalore (IN);  
**Pierre Perez**, Aurora, IL (US)

The ornamental design for a connector shroud, as shown and described.

(73) Assignee: **Molex, LLC**, Lisle, IL (US)

**DESCRIPTION**

(\*\*) Term: **15 Years**

(21) Appl. No.: **29/700,156**

(22) Filed: **Jul. 31, 2019**

(51) **LOC (13) Cl.** ..... **13-03**

(52) **U.S. Cl.**  
USPC ..... **D13/156**

(58) **Field of Classification Search**  
USPC ..... D13/110, 156, 133, 155, 184, 154, 162,  
D13/152, 118, 120  
CPC ..... H01R 13/41; H01R 13/52; H02G 3/086;  
Y10T 16/46  
See application file for complete search history.

FIG. 1 is a front perspective view of a connector shroud showing our new design;  
FIG. 2 is a rear perspective view thereof;  
FIG. 3 is a front view thereof;  
FIG. 4 is a rear view thereof;  
FIG. 5 is a right side view thereof;  
FIG. 6 is a left side view thereof;  
FIG. 7 is a top view thereof;  
FIG. 8 is a bottom view thereof;  
FIG. 9 is a front perspective view of an alternate embodiment of a connector shroud showing our new design;  
FIG. 10 is a rear perspective view thereof;  
FIG. 11 is a front view thereof;  
FIG. 12 is a rear view thereof;  
FIG. 13 is a right side view thereof;  
FIG. 14 is a left side view thereof;  
FIG. 15 is a top view thereof;  
FIG. 16 is a bottom view thereof;  
FIG. 17 is a front perspective view of an alternate embodiment of a connector shroud showing our new design;  
FIG. 18 is a rear perspective view thereof;  
FIG. 19 is a front view thereof;  
FIG. 20 is a rear view thereof;  
FIG. 21 is a right side view thereof;  
FIG. 22 is a left side view thereof;  
FIG. 23 is a top view thereof; and,  
FIG. 24 is a bottom view thereof.

(56) **References Cited**

**U.S. PATENT DOCUMENTS**

D375,292 S \* 11/1996 D'Amato ..... D13/137.1  
D603,085 S \* 10/2009 Kovacs ..... D26/113  
D633,870 S \* 3/2011 Thommes ..... D13/139.1  
D676,388 S \* 2/2013 Muller ..... D13/147  
D726,950 S 4/2015 Serwacki et al.  
D745,211 S 12/2015 Serwacki et al.

(Continued)

**FOREIGN PATENT DOCUMENTS**

TW D174716 4/2016  
TW D184271 7/2017

(Continued)

The broken line showing of the elliptical and circular regions and the unshaded areas therein, including the broken line showing of additional regions, form no part of the claimed design.

*Primary Examiner* — Jennifer O King

**1 Claim, 24 Drawing Sheets**

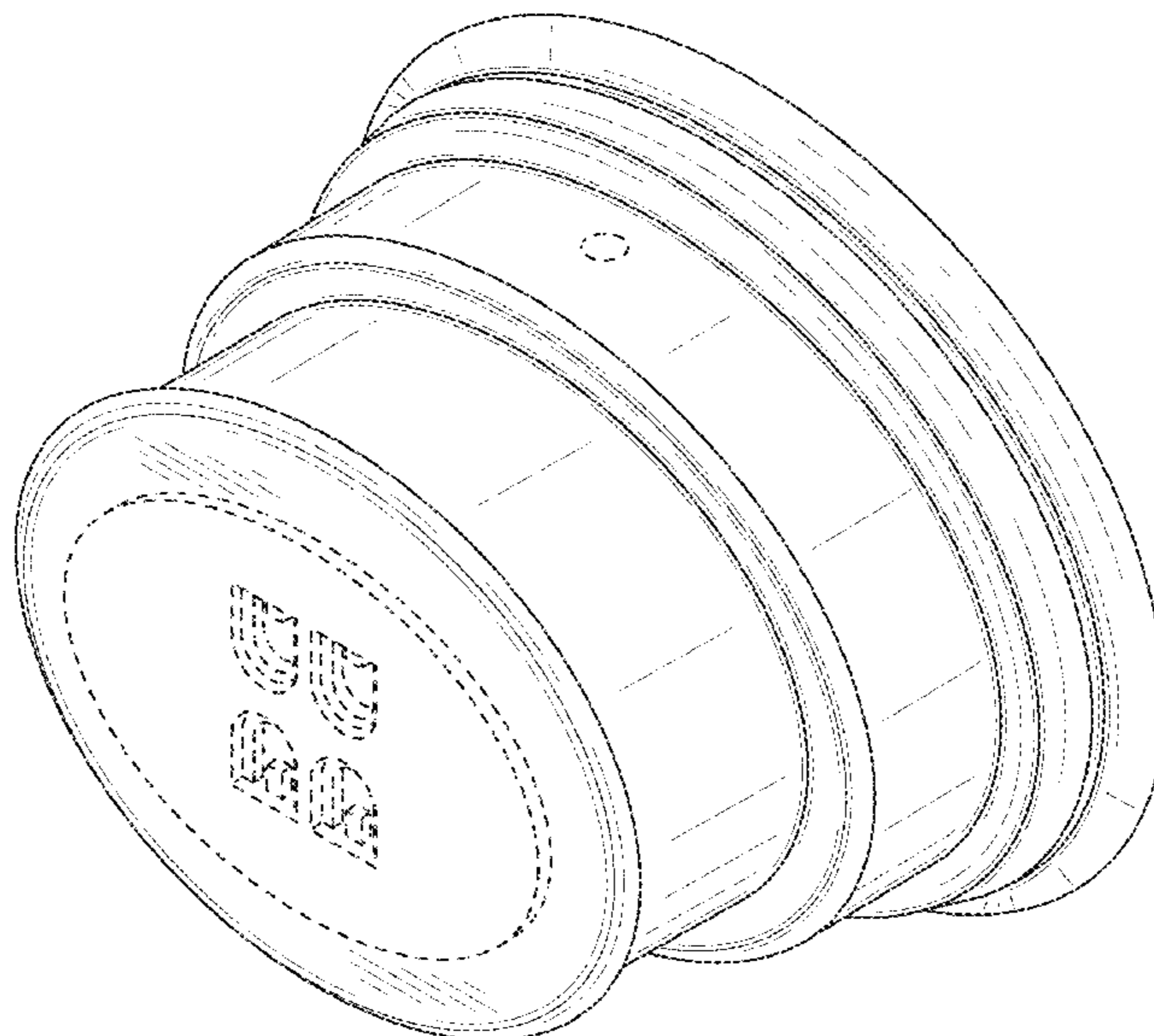

(56)

**References Cited**

U.S. PATENT DOCUMENTS

D747,540 S 1/2016 Serwacki et al.  
D807,829 S \* 1/2018 Byrne ..... D13/138.2  
D848,374 S \* 5/2019 Gregori ..... D13/147  
D861,611 S \* 10/2019 Wang ..... D13/133  
D886,061 S \* 6/2020 Wang ..... D13/133  
D889,416 S \* 7/2020 Zhao ..... D13/153  
D911,965 S \* 3/2021 C ..... D13/133  
2011/0189877 A1\* 8/2011 Svelnis ..... H01R 13/639  
439/271  
2013/0267108 A1\* 10/2013 Nagamine ..... H01R 13/5219  
439/271  
2020/0335891 A1\* 10/2020 Eisfeld ..... H01R 12/7076

FOREIGN PATENT DOCUMENTS

TW D191412 7/2018  
TW D195941 2/2019

\* cited by examiner

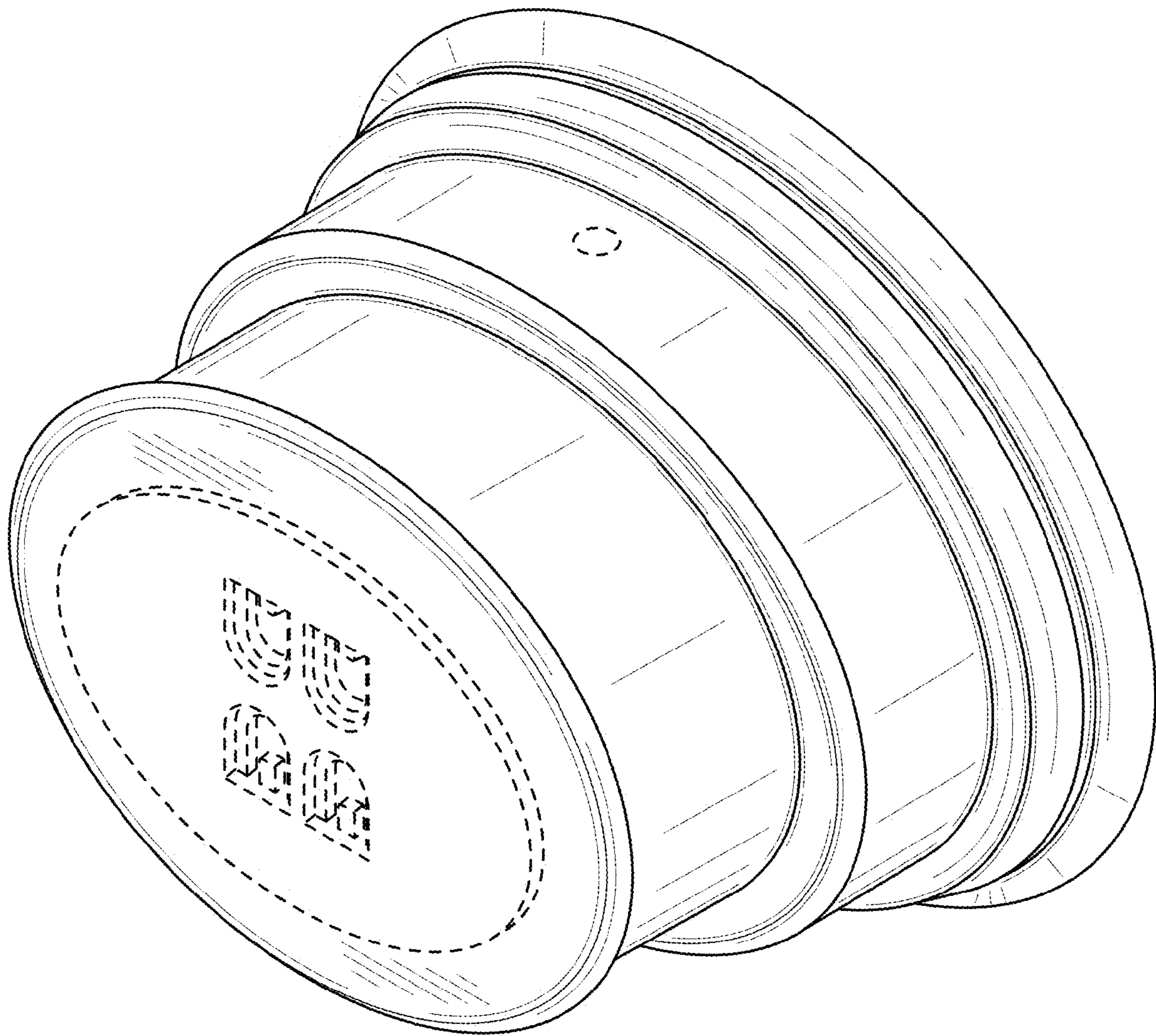

FIG. 1

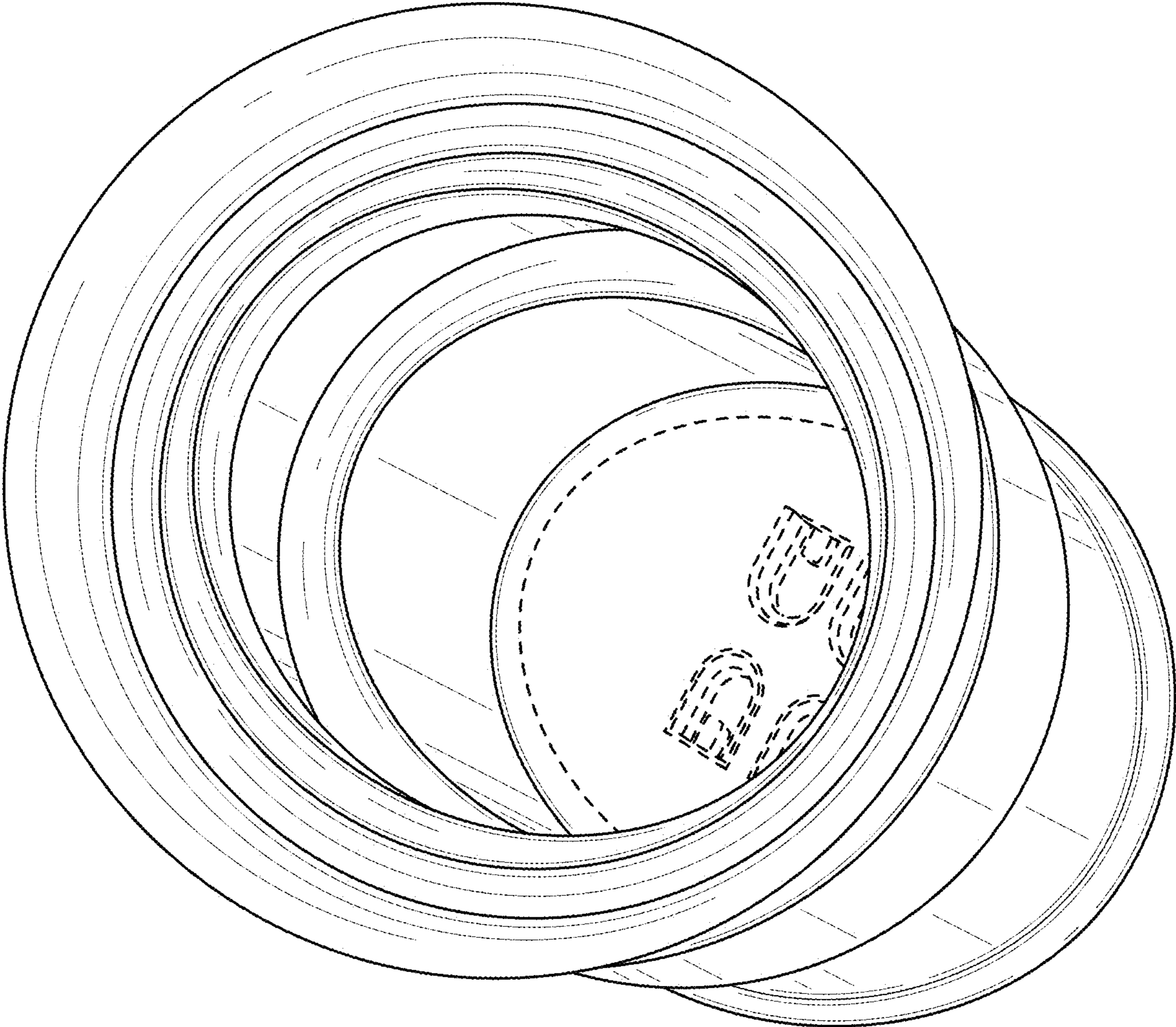

FIG. 2

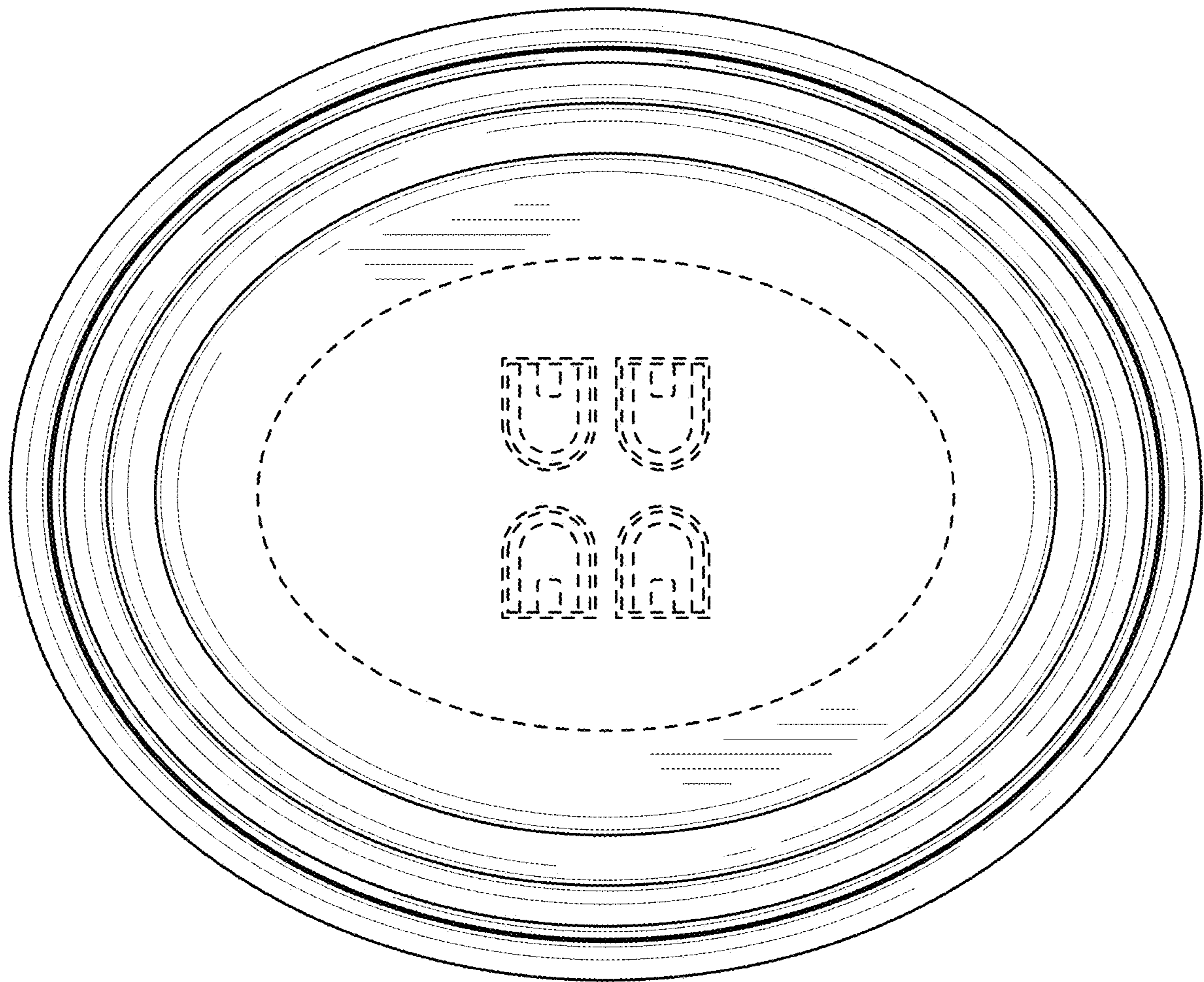

FIG. 3

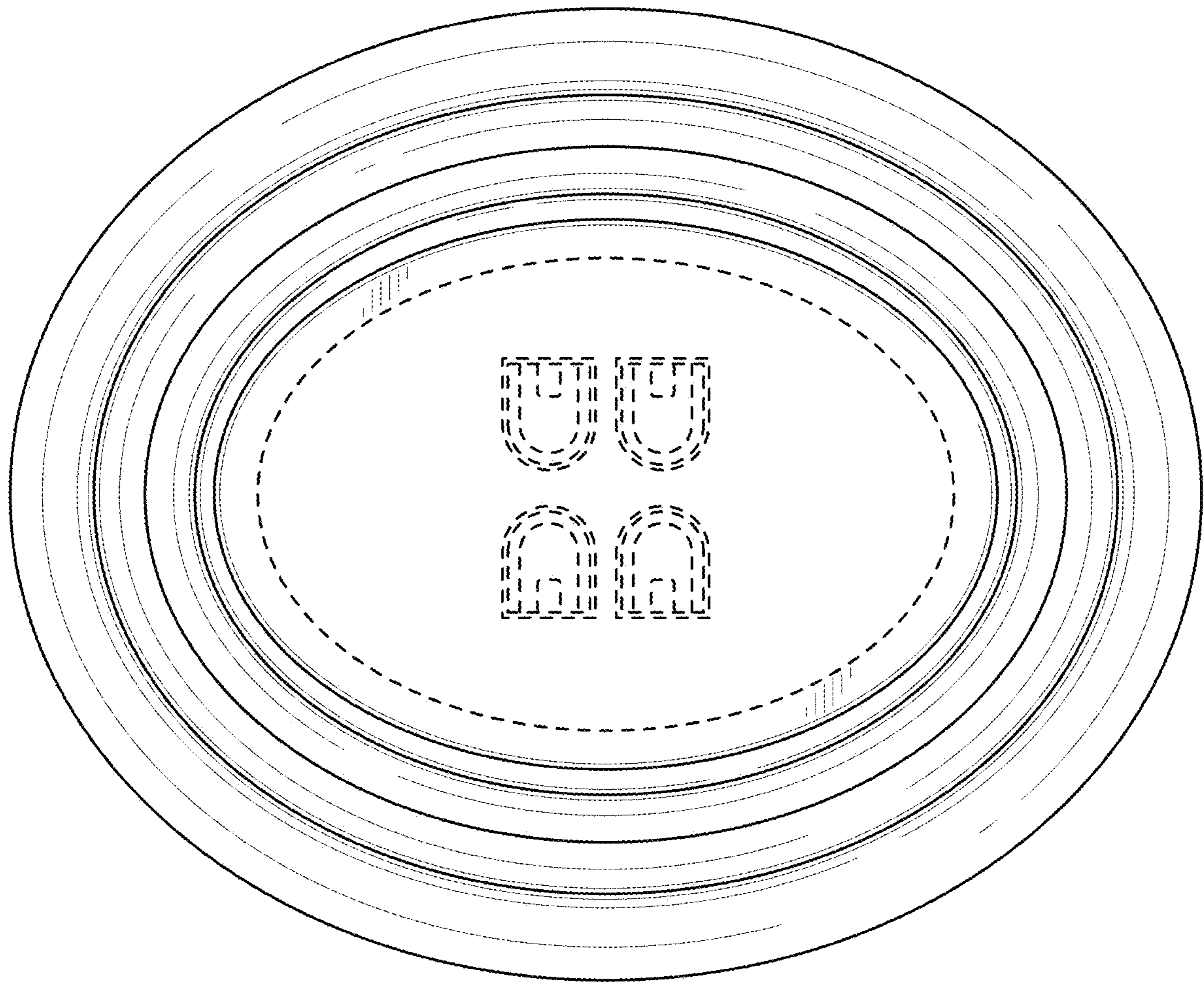

FIG. 4

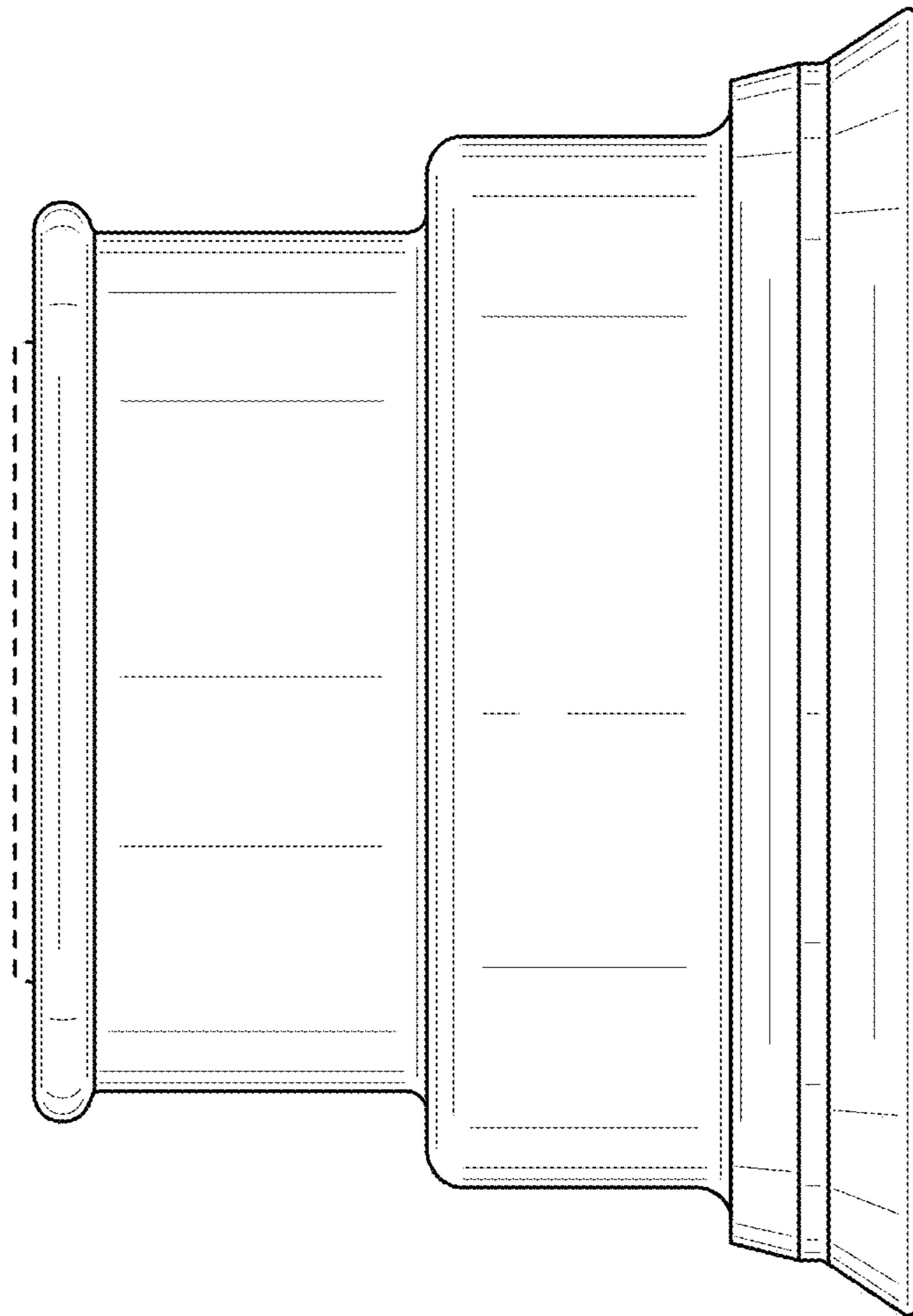

FIG. 5

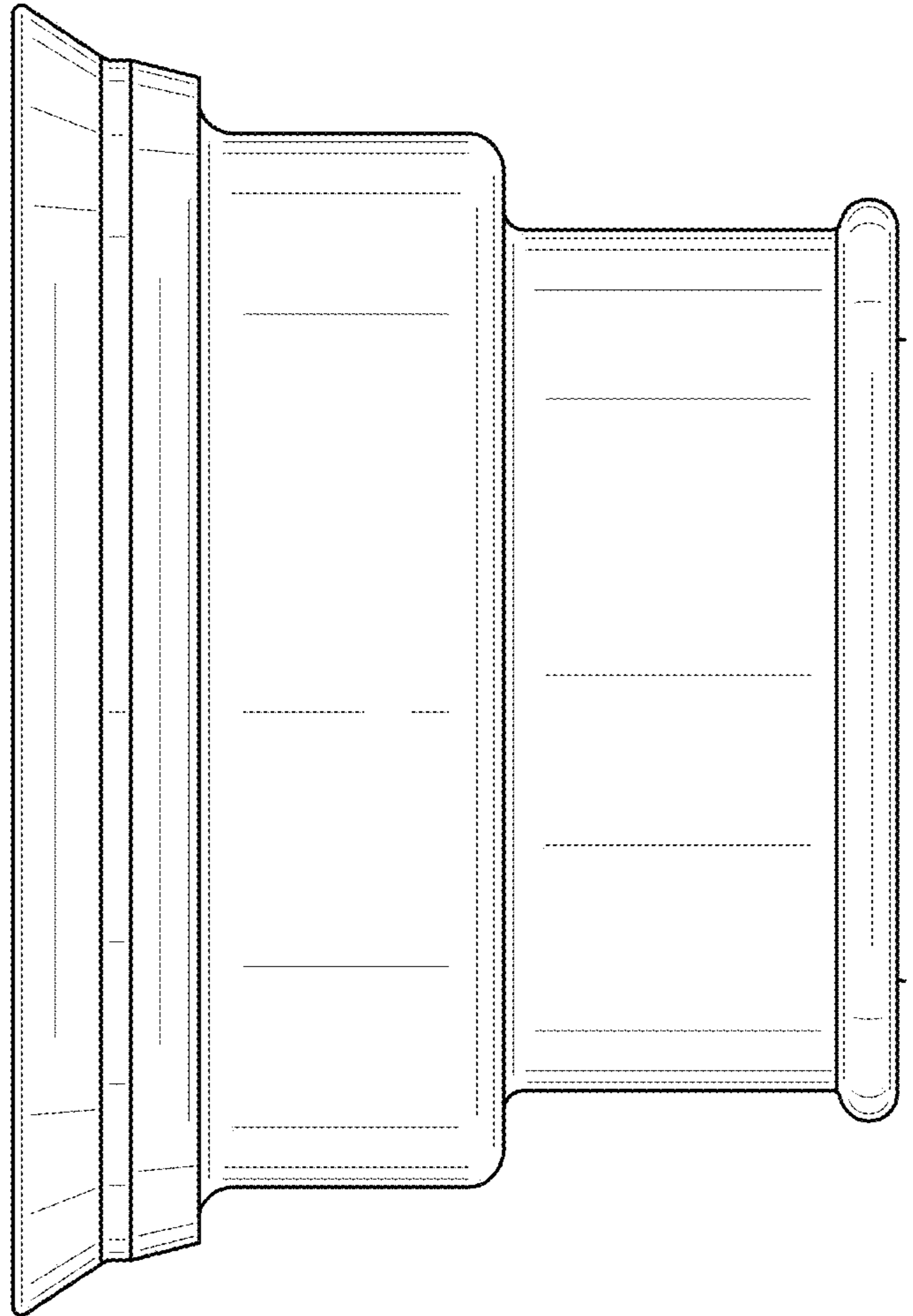

FIG. 6



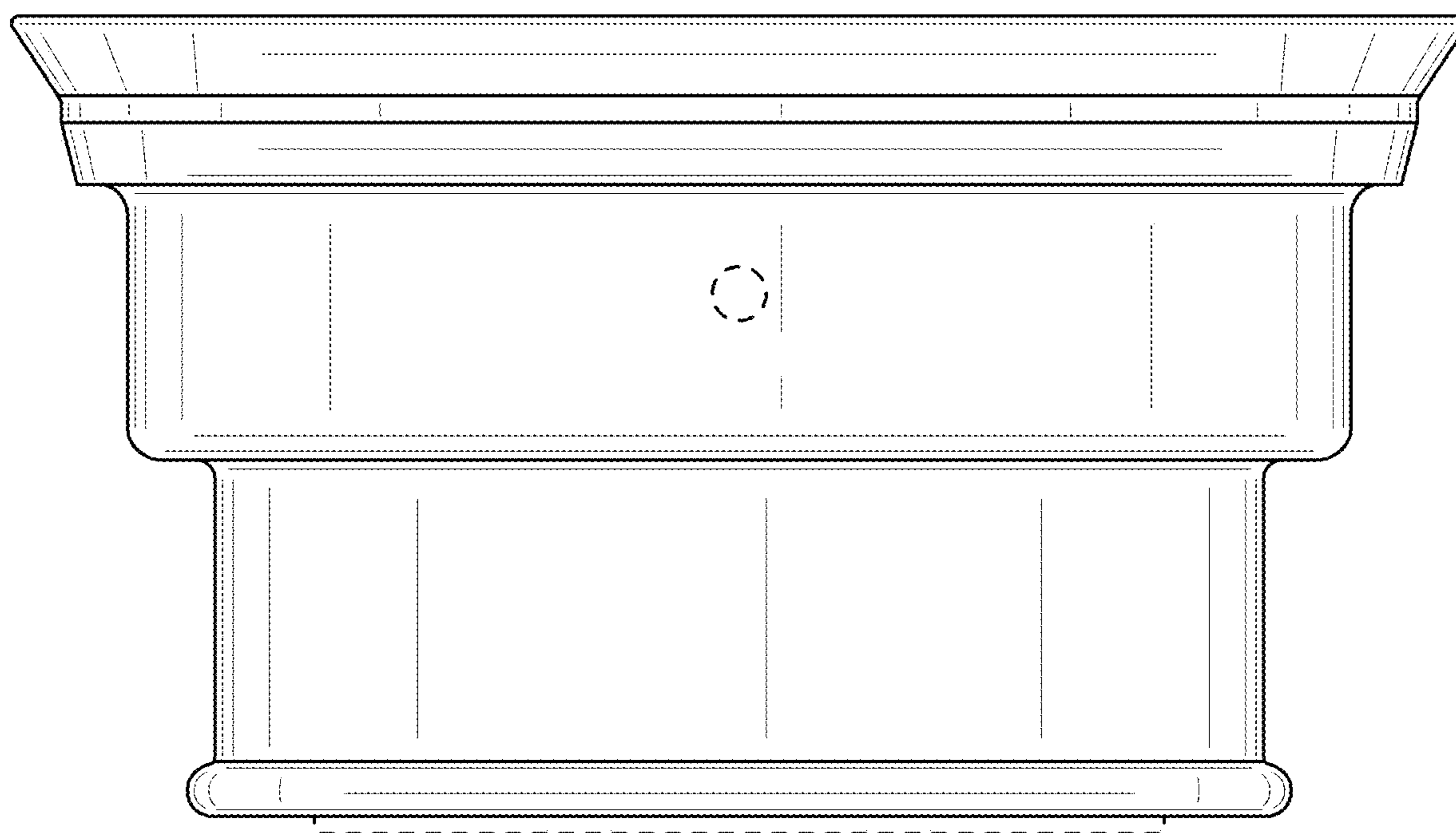

FIG. 7

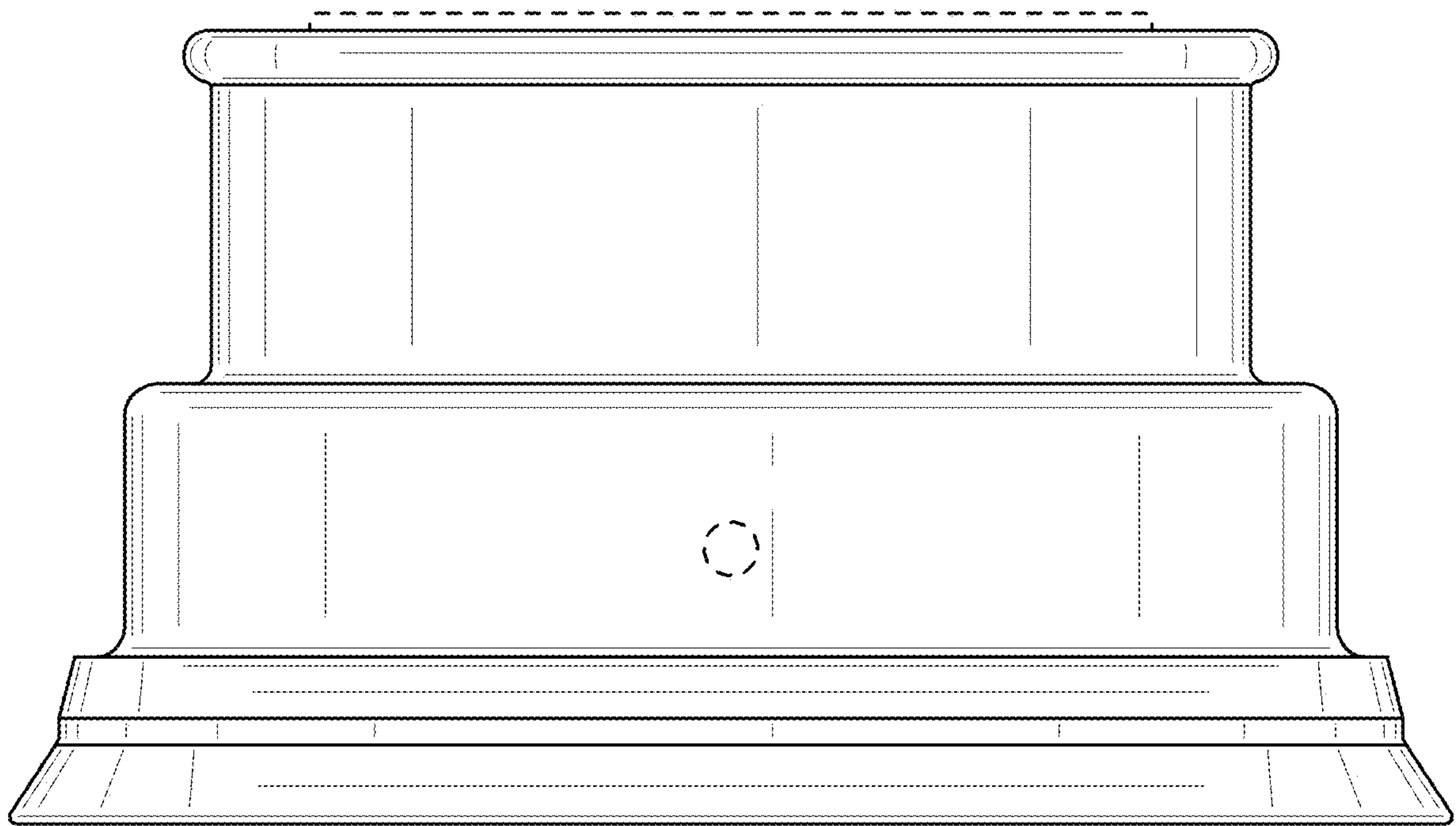

FIG. 8

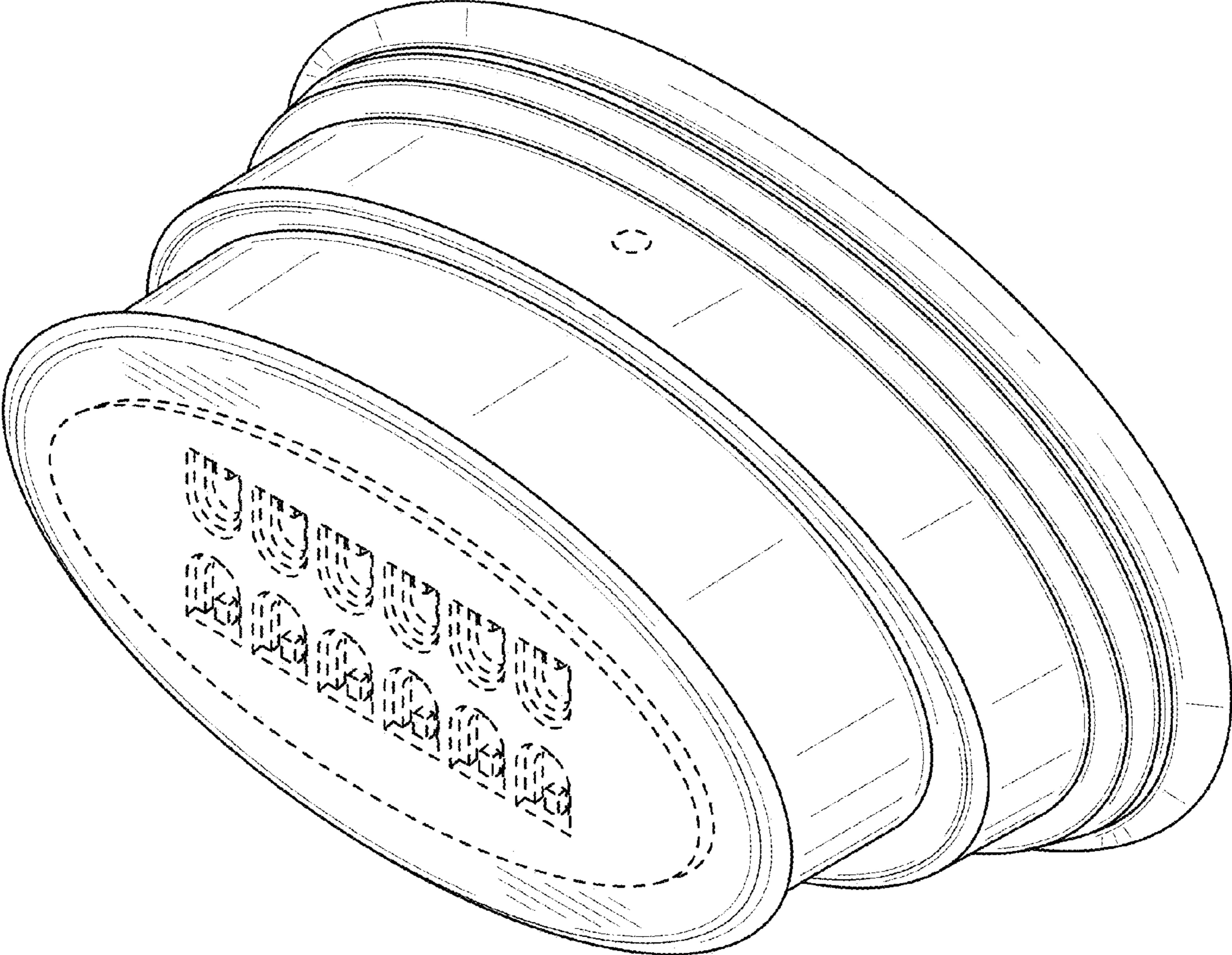

FIG. 9

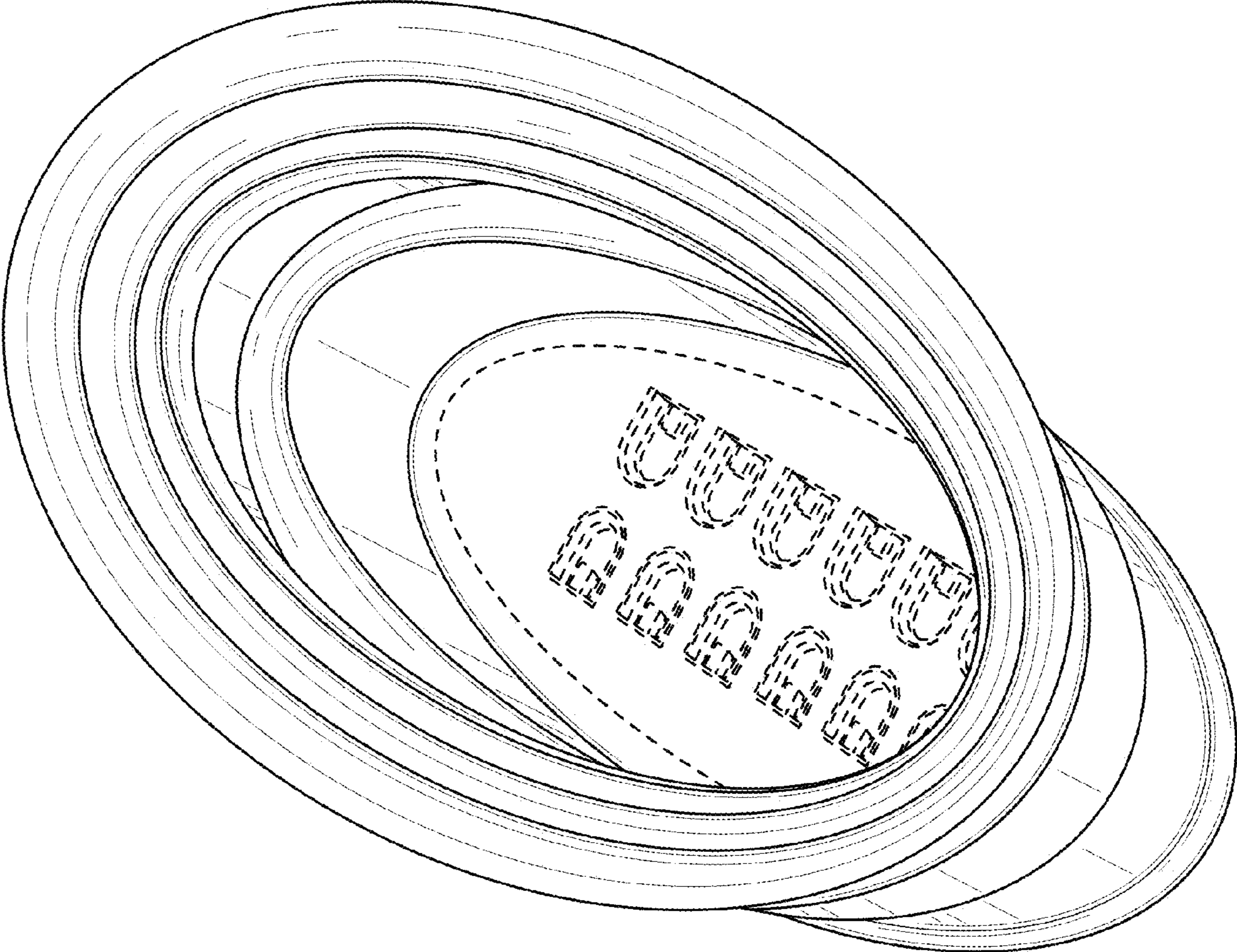

FIG. 10

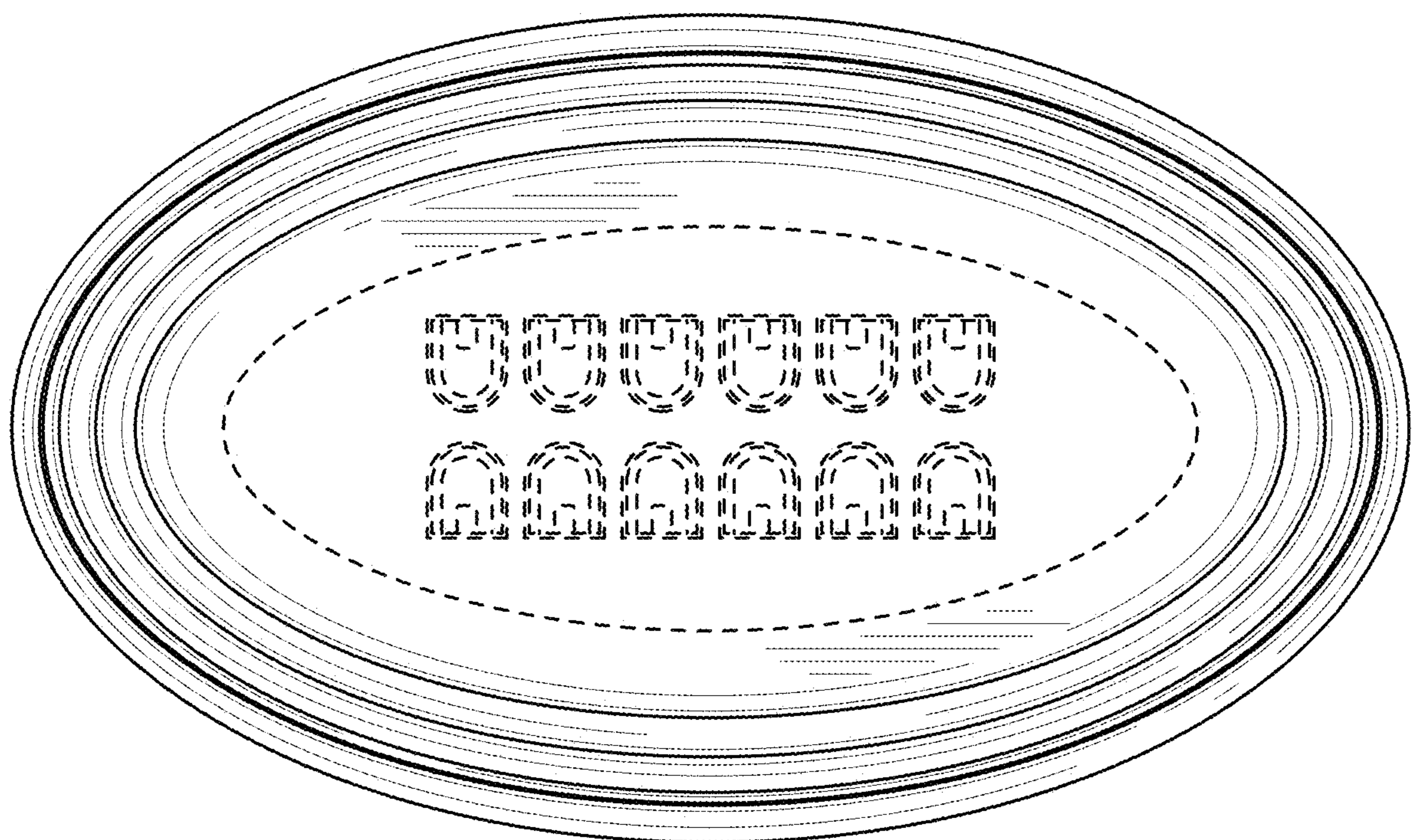

FIG. 11

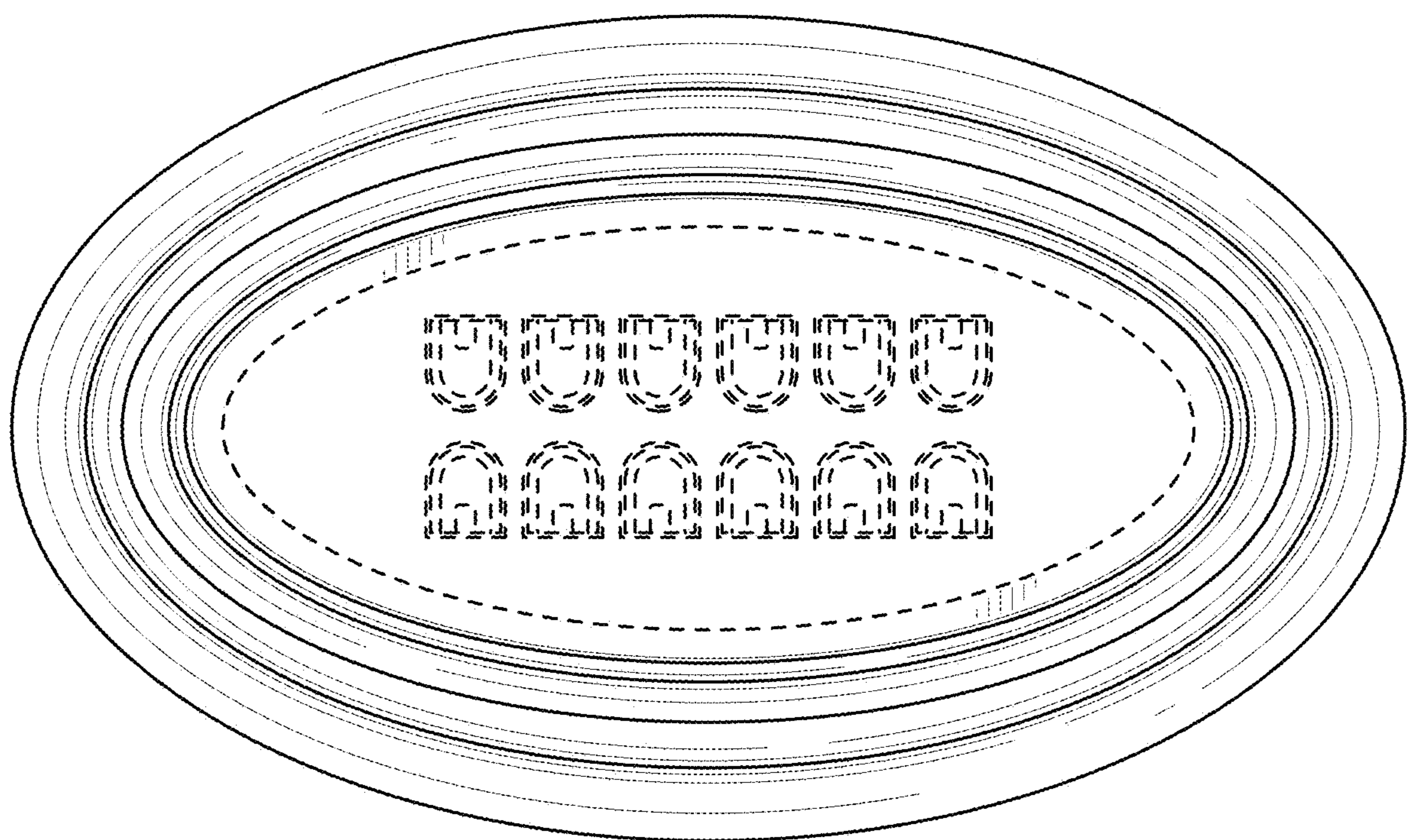

FIG. 12

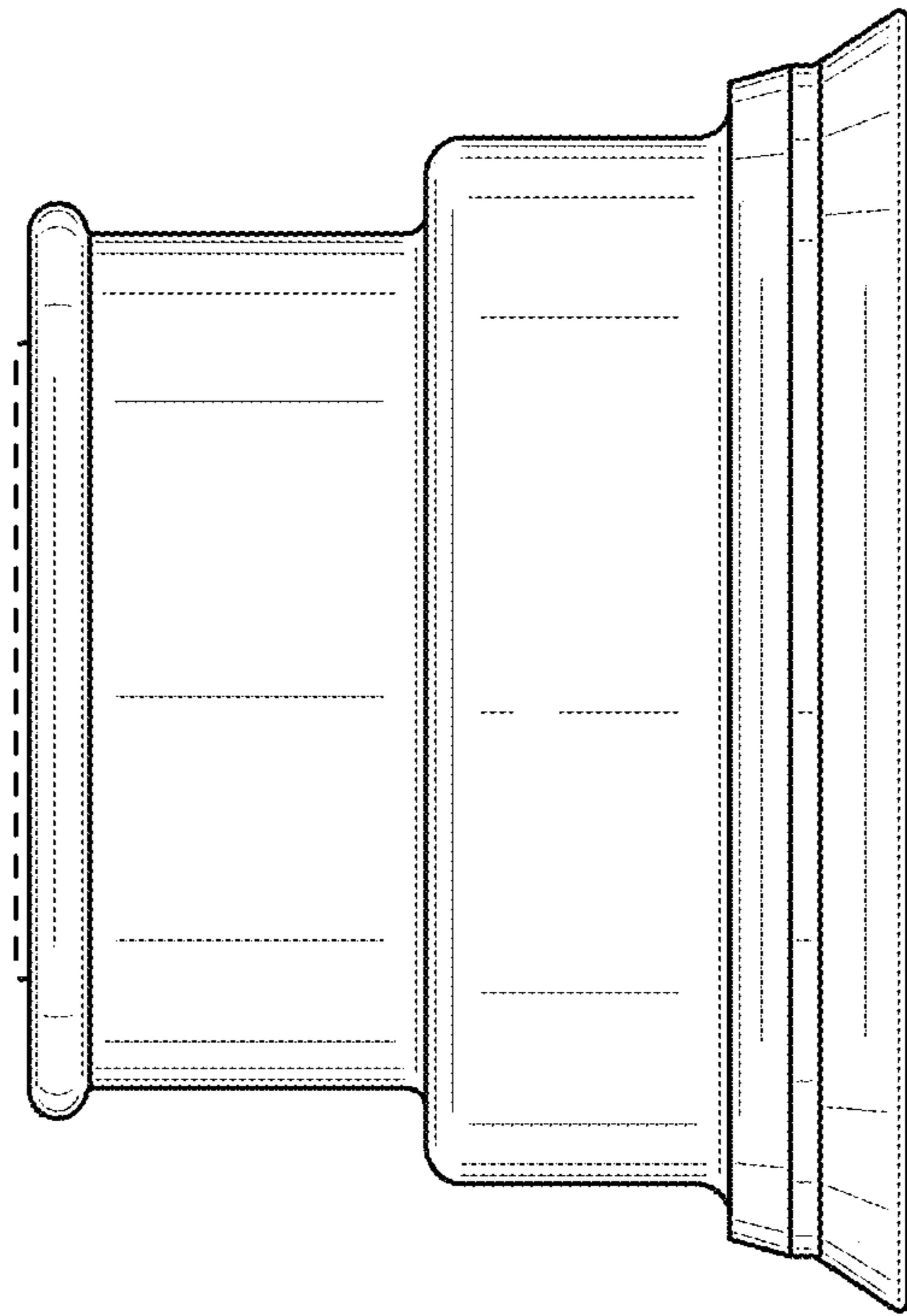

FIG. 13

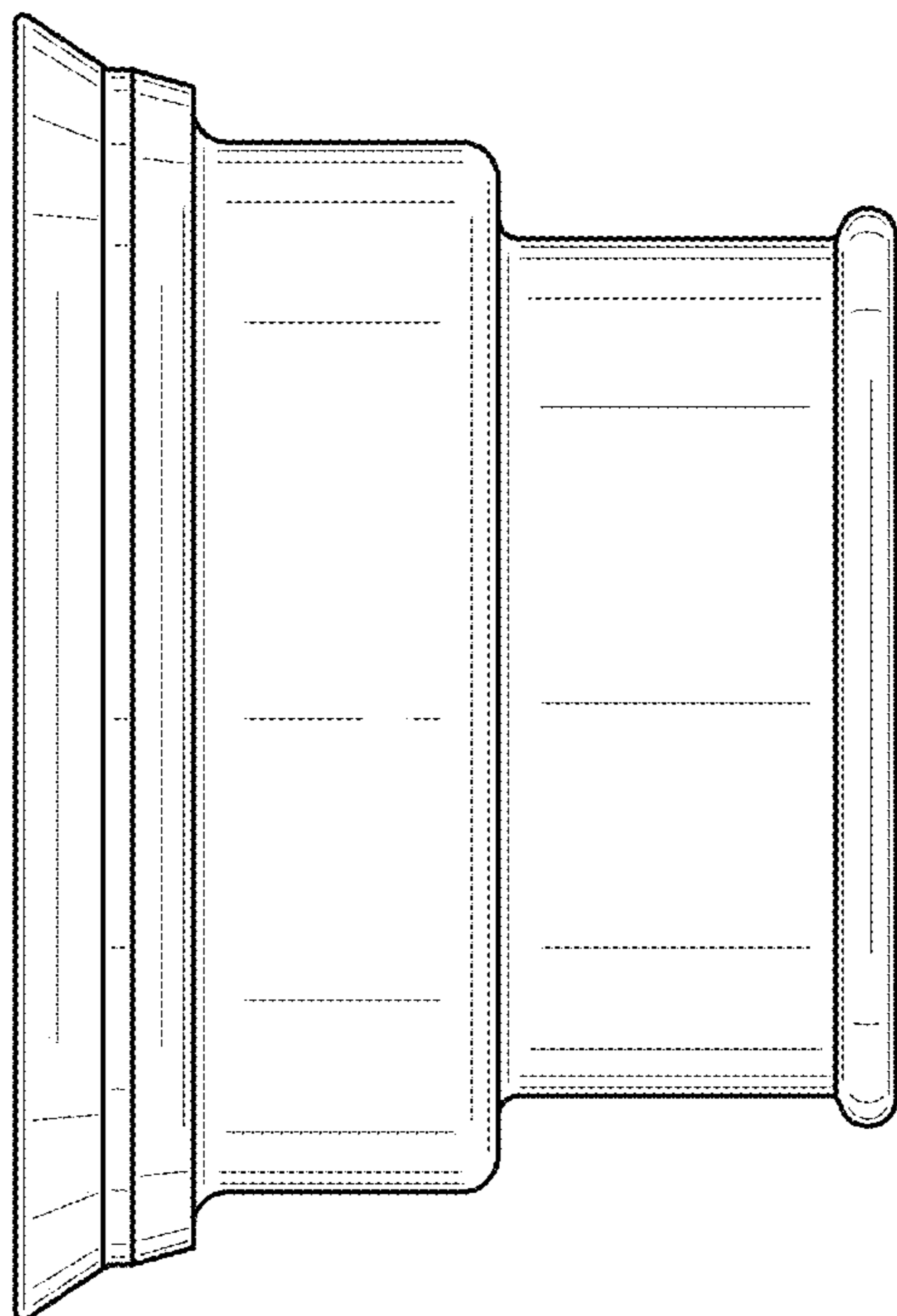

FIG. 14



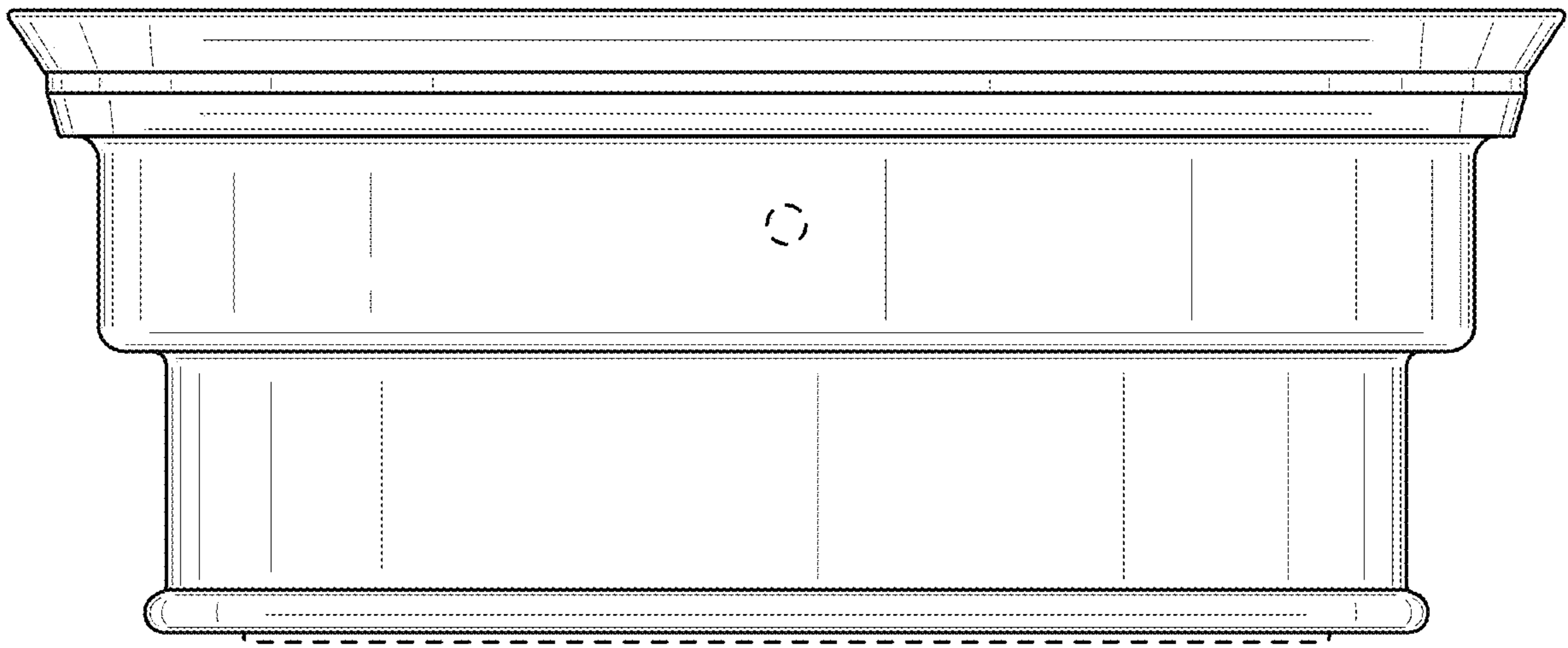

FIG. 15

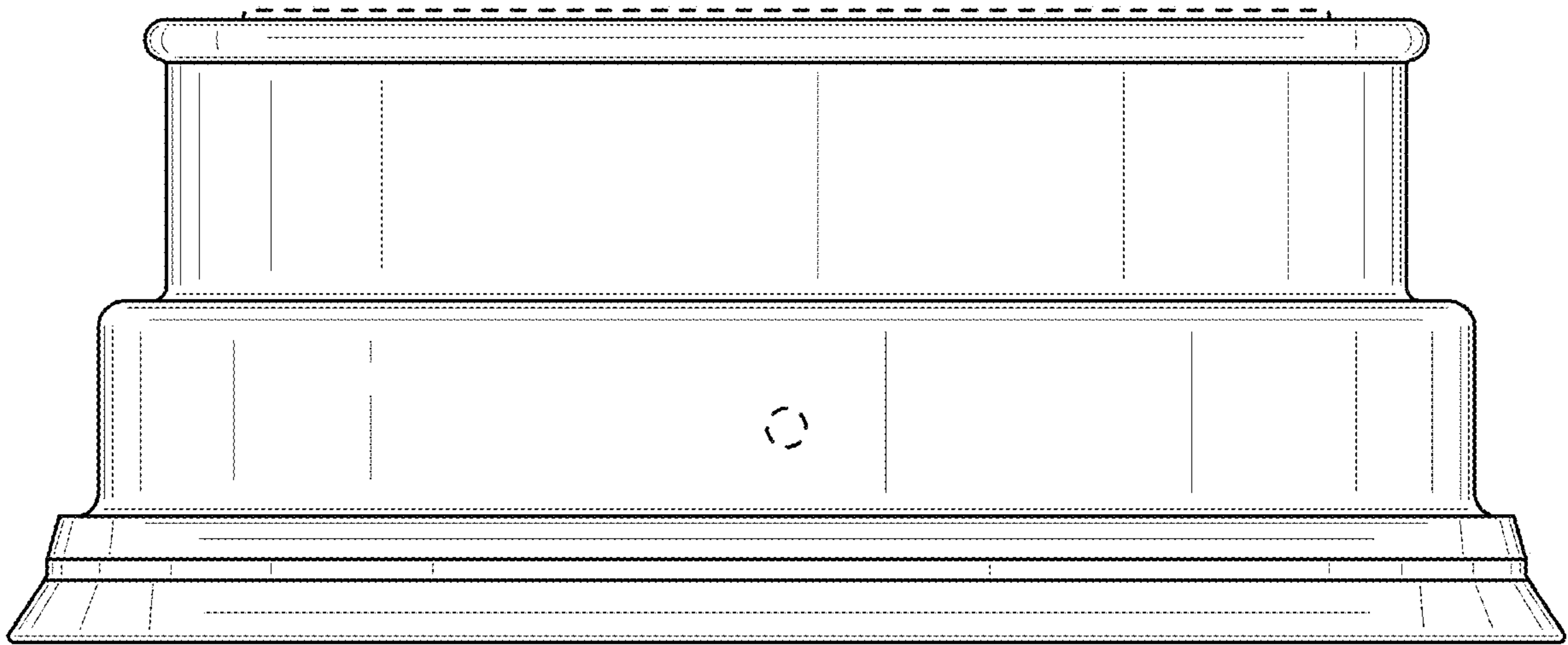

FIG. 16

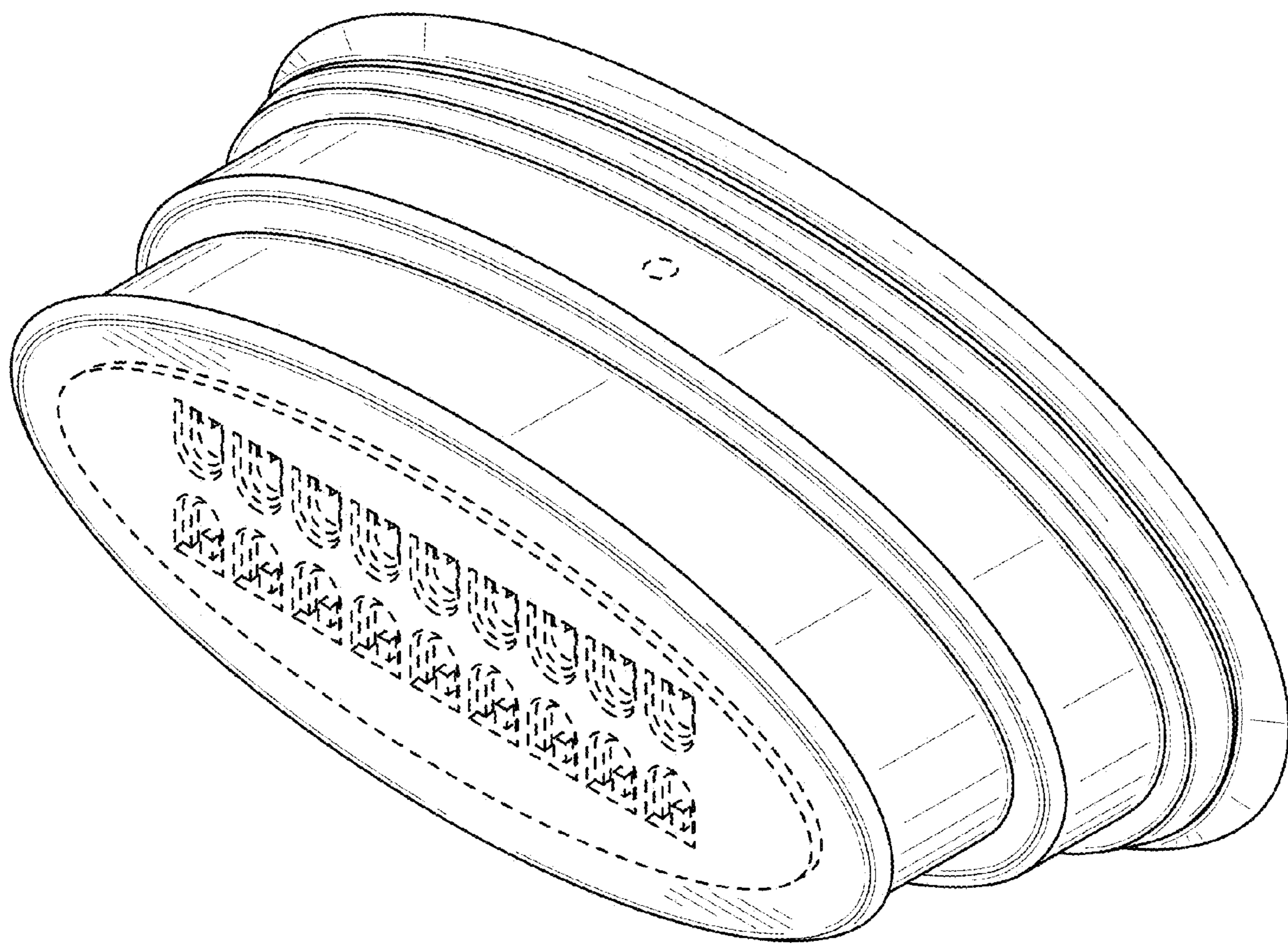

FIG. 17

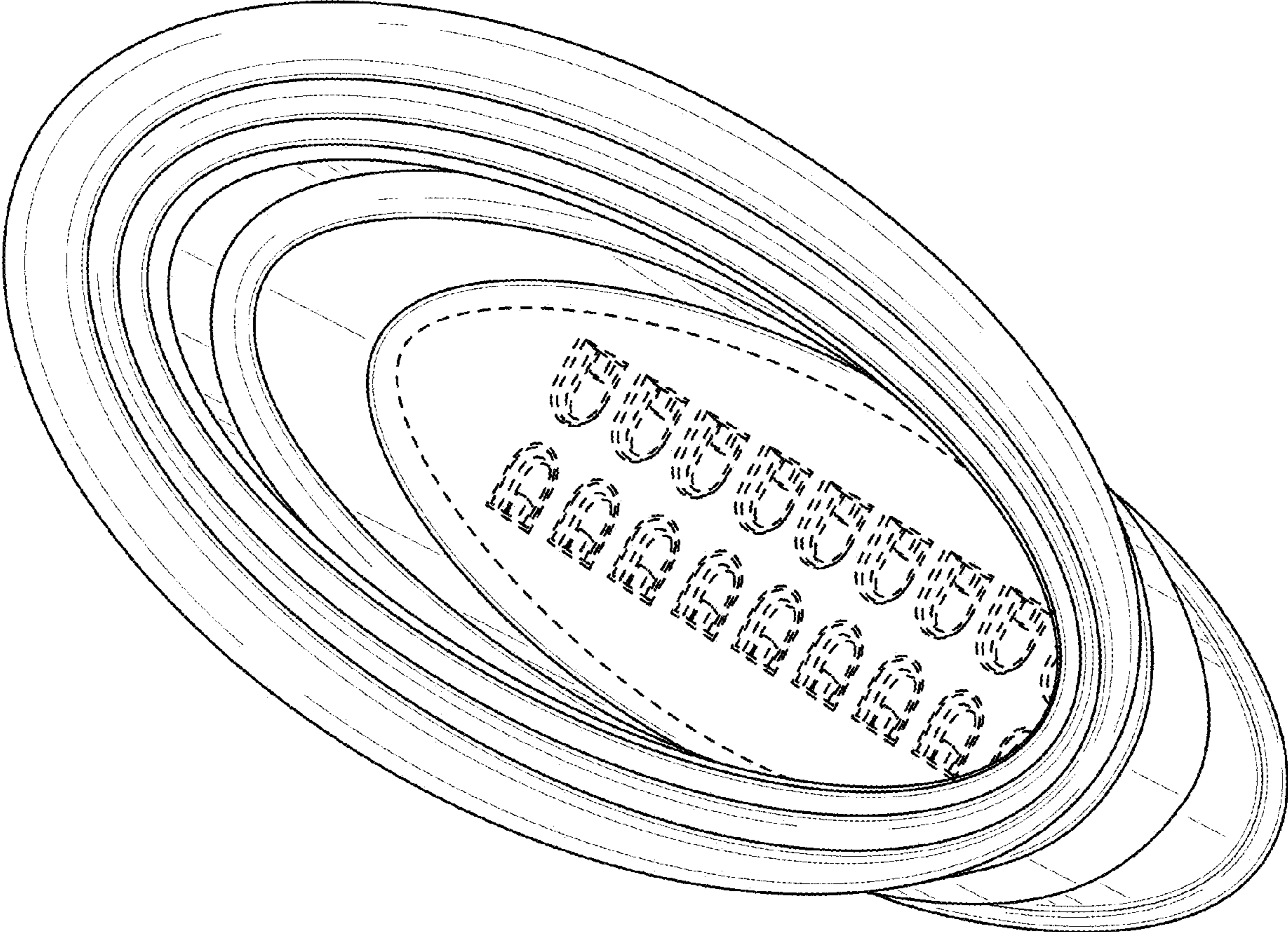

FIG. 18

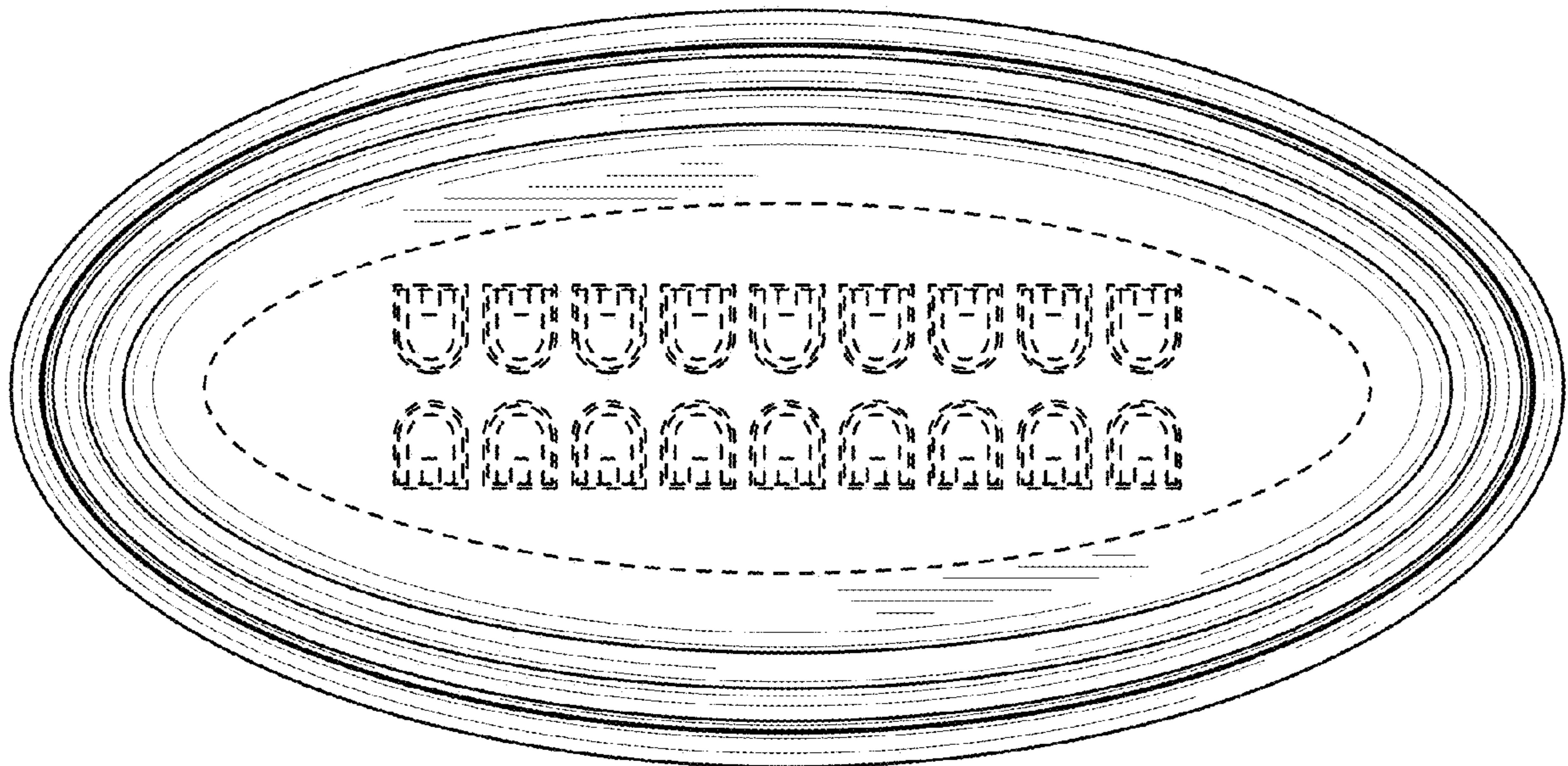

FIG. 19

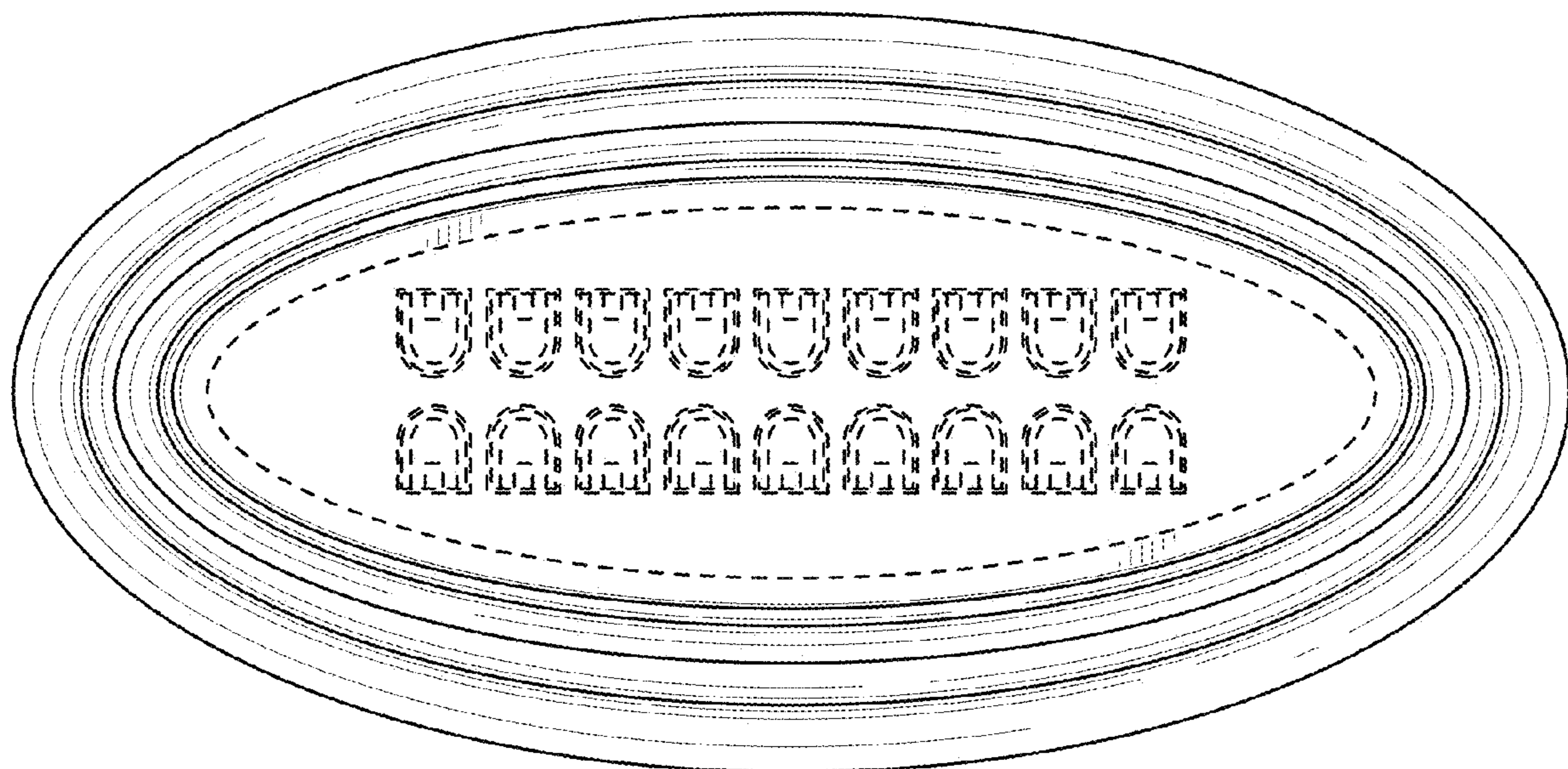

FIG. 20

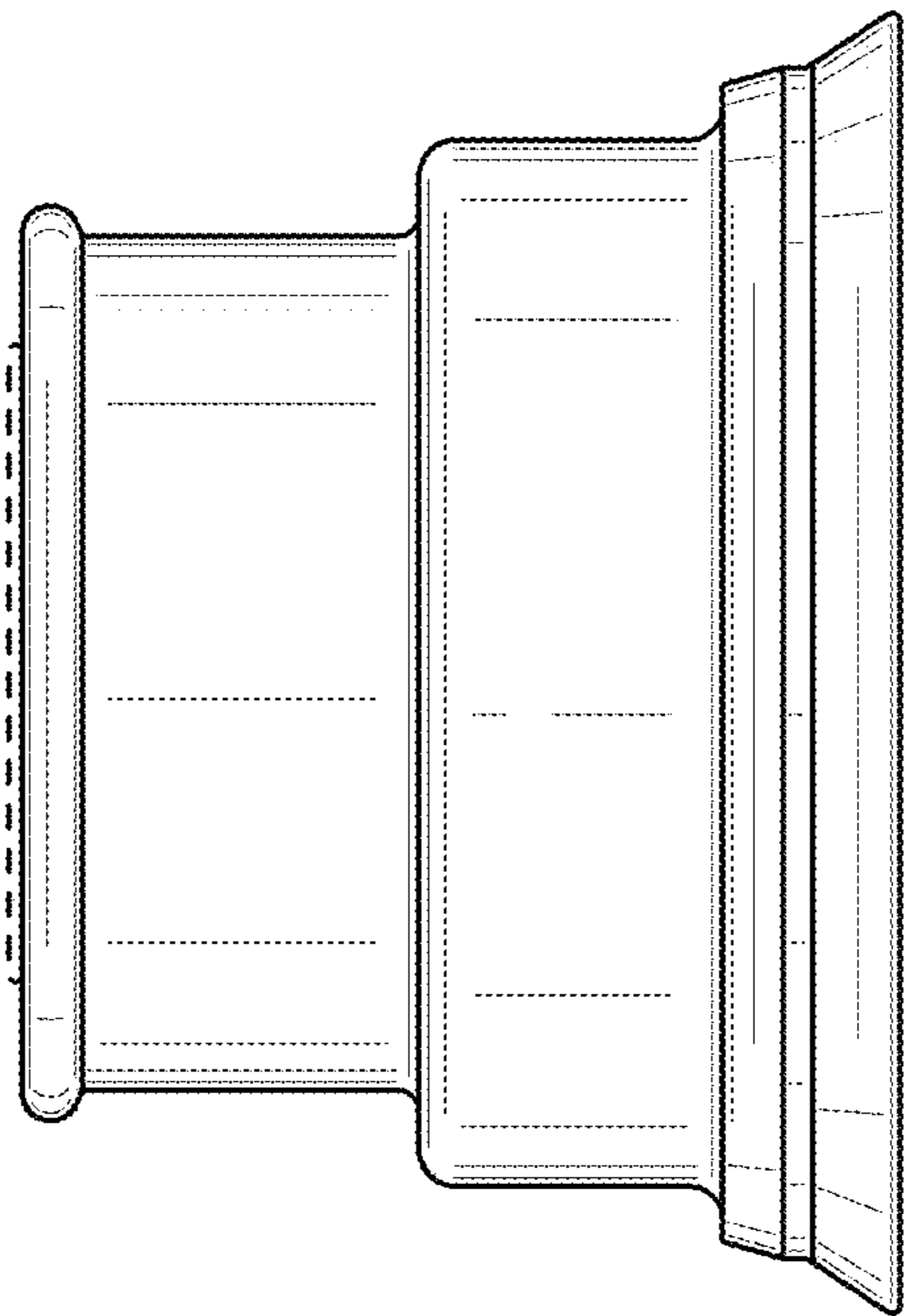

FIG. 21

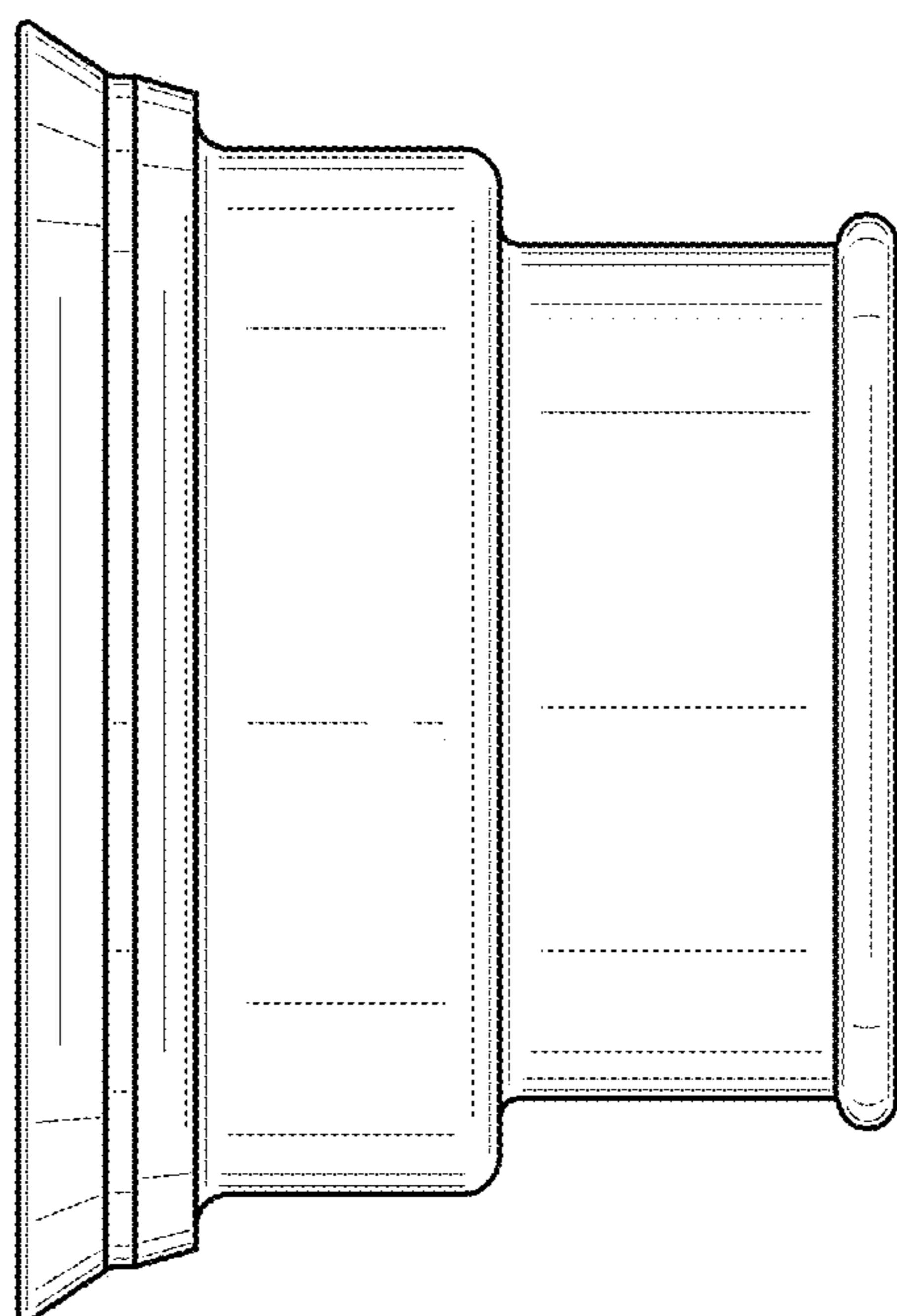

FIG. 22



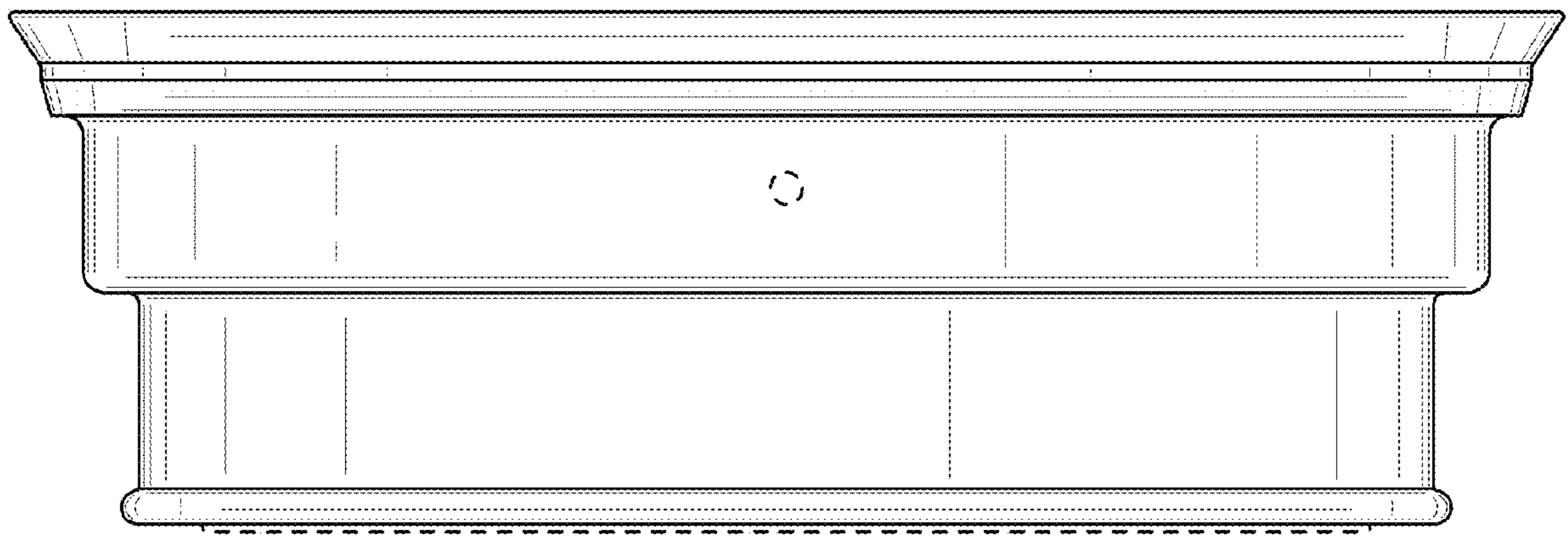

FIG. 23

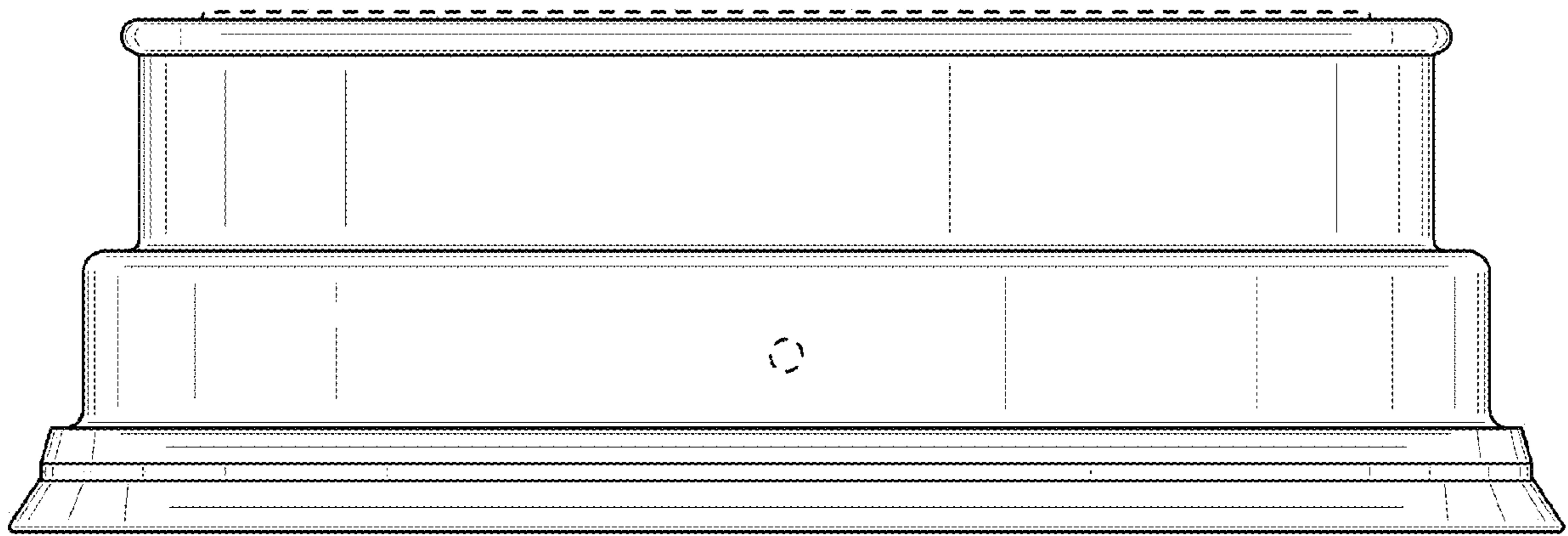

FIG. 24