



US00D930529S

(12) **United States Design Patent**
Park et al.

(10) **Patent No.:** **US D930,529 S**

(45) **Date of Patent:** **** Sep. 14, 2021**

(54) **VEHICLE FRONT FASCIA**
(71) Applicant: **GM GLOBAL TECHNOLOGY OPERATIONS LLC**, Detroit, MI (US)
(72) Inventors: **Jonghyuk Park**, Troy, MI (US);
Eduardo Okamoto, Royal Oak, MI (US)
(73) Assignee: **GM Global Technology Operations LLC**, Detroit, MI (US)

(**) Term: **15 Years**

(21) Appl. No.: **29/724,883**

(22) Filed: **Feb. 20, 2020**

(51) **LOC (13) Cl.** **12-16**

(52) **U.S. Cl.**
USPC **D12/169**

(58) **Field of Classification Search**
USPC D12/1, 85, 86, 88, 89, 90, 91, 92, 93,
D12/101, 102, 106, 144, 163, 164, 167,
D12/169, 171, 173, 181, 184, 185, 190,
D12/192, 196, 216, 400; D21/533, 548,
D21/552, 561; D15/28

CPC B60R 19/00; B60R 19/02; B60R 19/04;
B60R 19/18; B60R 19/24; B60R 19/52;
B60R 19/56; B60R 2019/007; B62D
25/00; B62D 25/08; B62D 35/00; B60K
11/08

See application file for complete search history.

(56) **References Cited**

U.S. PATENT DOCUMENTS

D287,115 S * 12/1986 Envall D12/190
D423,429 S * 4/2000 Hickman D12/169
D433,980 S * 11/2000 Conway D12/196
D434,358 S * 11/2000 Conway D12/196
D560,149 S * 1/2008 Leclercq D12/184

D564,423 S * 3/2008 Spearman-Oxx D12/169
D570,742 S 6/2008 Takagi et al.
D592,105 S 5/2009 Dean et al.
D597,447 S 8/2009 Folden
D600,595 S 9/2009 Nakamura et al.
D601,925 S 10/2009 O'Donnell
D603,755 S 11/2009 Peters
D604,203 S 11/2009 O'Donnell
D605,082 S 12/2009 Munson
D605,083 S 12/2009 Manoogian, II et al.
D605,977 S 12/2009 Zipfel et al.
D605,978 S 12/2009 Wolff et al.
D608,249 S 1/2010 Peters
D608,690 S 1/2010 Folden et al.
D608,691 S 1/2010 Zak, Jr. et al.
D609,608 S 2/2010 Boniface et al.
D611,387 S 3/2010 Thompson et al.
D611,879 S 3/2010 Kim et al.
D612,297 S 3/2010 Peters et al.
D613,645 S 4/2010 Song et al.

(Continued)

Primary Examiner — Christian P. McLean

Assistant Examiner — Adam C Mager

(57) **CLAIM**

The ornamental design for a vehicle front fascia, as shown and described.

DESCRIPTION

FIG. 1 is a front and left perspective view of a vehicle front fascia showing our new design; the mirror image of the vehicle front fascia is claimed, but not shown; FIG. 2 is a front elevation of the vehicle front fascia of FIG. 1;

FIG. 3 is a left elevation view thereof; FIG. 4 is a right elevation view thereof; FIG. 5 is a rear elevation view thereof; FIG. 6 is a top view thereof; and, FIG. 7 is a bottom view thereof.

The broken lines in the drawings depict portions of the vehicle front fascia that form no part of the claimed design.

1 Claim, 7 Drawing Sheets

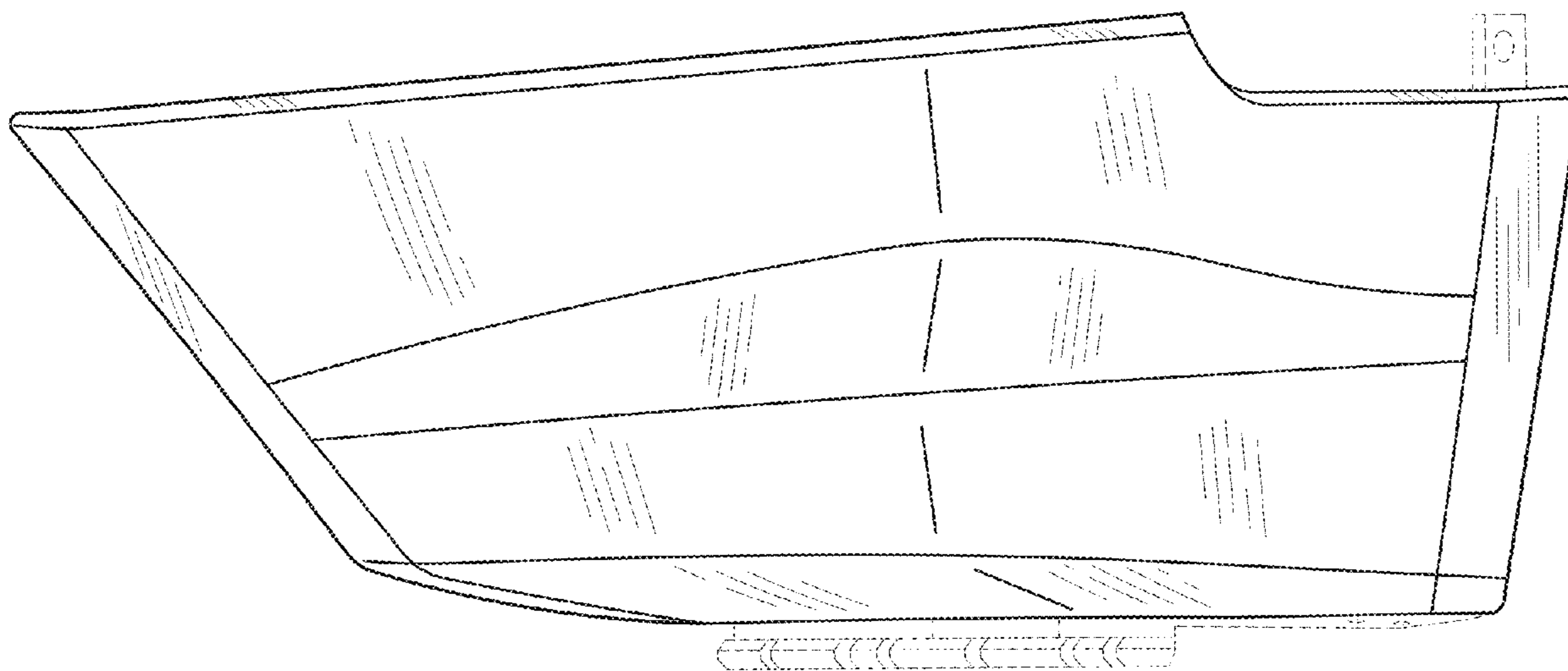

(56)

References Cited

U.S. PATENT DOCUMENTS

D615,458 S	5/2010	Thompson et al.	
D618,595 S	6/2010	Ware et al.	
D621,752 S *	8/2010	Angelo	D12/169
D623,090 S	9/2010	Cox et al.	
D627,262 S	11/2010	Ikeda et al.	
D635,488 S	4/2011	Phipps	
D637,122 S *	5/2011	Lamm	D12/169
D644,147 S	8/2011	Suh et al.	
D644,567 S	9/2011	Kozub	
D644,577 S *	9/2011	Messale	D12/169
D657,718 S	4/2012	Zipfel et al.	
D659,052 S	5/2012	Ware et al.	
D659,053 S	5/2012	Ware et al.	
D668,182 S	10/2012	Franco et al.	
D668,183 S	10/2012	Smart	
D678,820 S	3/2013	Son et al.	
D678,821 S	3/2013	Ikeda et al.	
D680,909 S	4/2013	Munson et al.	
D680,910 S	4/2013	David	
D684,899 S	6/2013	Baker	
D686,536 S	7/2013	McCabe et al.	
D692,798 S	11/2013	Thurber	
D692,799 S	11/2013	Smith et al.	
D696,157 S	12/2013	Loeb	
D699,629 S	2/2014	Ikeda et al.	
D700,871 S	3/2014	O'Donnell et al.	
D703,103 S	4/2014	Lee	
D704,103 S	5/2014	Mack et al.	
D705,132 S	5/2014	Ware et al.	
D705,699 S	5/2014	Ware et al.	
D710,767 S *	8/2014	Heilaneh	D12/169
D713,298 S	9/2014	Dyson	
D713,764 S	9/2014	Ferlazzo et al.	
D716,696 S	11/2014	Thole et al.	
D716,706 S	11/2014	Thole et al.	
D716,709 S	11/2014	Thole et al.	
D717,696 S	11/2014	Thole et al.	
D718,189 S	11/2014	Krieg et al.	
D718,683 S	12/2014	Thole et al.	
D722,282 S	2/2015	Loeb	
D722,533 S	2/2015	Thole et al.	
D722,534 S	2/2015	Munson et al.	
D724,510 S	3/2015	McMahan et al.	
D725,001 S	3/2015	McMahan et al.	
D726,591 S	4/2015	Jacob	
D730,776 S	6/2015	Smart	
D730,783 S	6/2015	Henriques et al.	
D732,427 S	6/2015	Loeb	
D732,429 S	6/2015	Loeb	
D732,430 S	6/2015	Loeb	
D732,431 S	6/2015	Loeb	
D732,432 S	6/2015	Aengenheyster	
D732,433 S	6/2015	Aengenheyster	
D732,435 S	6/2015	Mackay	
D733,002 S	6/2015	Loeb	
D735,611 S	8/2015	Aengenheyster	
D735,627 S	8/2015	Smith	
D736,451 S	8/2015	Smith	
D739,306 S	9/2015	McMahan et al.	
D739,317 S	9/2015	McMahan et al.	
D741,223 S	10/2015	Kim et al.	
D743,309 S	11/2015	Thole et al.	
D743,313 S	11/2015	Smith et al.	
D743,314 S	11/2015	Thole et al.	
D743,857 S	11/2015	McMahan et al.	
D744,158 S	11/2015	Willett et al.	
D745,086 S	12/2015	Finos et al.	
D745,719 S	12/2015	Boniface et al.	
D745,725 S	12/2015	McMahan et al.	
D745,726 S	12/2015	McMahan et al.	
D745,837 S	12/2015	Smith et al.	
D746,726 S	1/2016	Smith et al.	
D746,727 S	1/2016	Smith et al.	
D746,728 S	1/2016	Smith et al.	
D746,729 S	1/2016	Boniface et al.	
D746,730 S	1/2016	Kim et al.	
D747,514 S	1/2016	McMahan et al.	
D747,515 S	1/2016	McMahan et al.	
D747,819 S	1/2016	Thole et al.	
D749,021 S	2/2016	Boniface et al.	
D749,026 S	2/2016	Smith et al.	
D749,027 S	2/2016	McMahan et al.	
D749,246 S	2/2016	Thole et al.	
D749,249 S	2/2016	Thole et al.	
D749,250 S	2/2016	Thole et al.	
D749,985 S	2/2016	Kozub et al.	
D749,997 S	2/2016	McMahan et al.	
D750,001 S	2/2016	Thole et al.	
D753,032 S	4/2016	Smith et al.	
D753,033 S	4/2016	Thole et al.	
D753,034 S	4/2016	Thole et al.	
D753,035 S	4/2016	Boniface et al.	
D753,559 S	4/2016	McMahan et al.	
D753,560 S	4/2016	McMahan et al.	
D753,567 S	4/2016	Boniface et al.	
D754,571 S	4/2016	Boniface et al.	
D754,572 S	4/2016	McMahan et al.	
D755,088 S	5/2016	McMahan et al.	
D756,869 S	5/2016	McMahan et al.	
D758,271 S	6/2016	McMahan et al.	
D764,975 S	8/2016	Aengenheyster	
D764,976 S	8/2016	Aengenheyster	
D767,449 S	9/2016	Pevovar et al.	
D767,450 S	9/2016	Lee et al.	
D767,451 S	9/2016	Kozub et al.	
D767,454 S	9/2016	McMahan et al.	
D767,458 S	9/2016	Kim	
D767,459 S	9/2016	Kim	
D767,460 S	9/2016	Kozub et al.	
D767,461 S	9/2016	Kozub et al.	
D771,528 S	11/2016	Smith et al.	
D771,529 S	11/2016	Thole et al.	
D771,532 S	11/2016	Kapitonov	
D771,533 S	11/2016	Kapitonov	
D772,766 S	11/2016	Kozub et al.	
D772,767 S	11/2016	Kim	
D773,084 S	11/2016	Kapitonov	
D773,086 S	11/2016	McCabe et al.	
D774,226 S	12/2016	McCabe et al.	
D775,003 S	12/2016	Pevovar et al.	
D775,007 S	12/2016	Thole et al.	
D775,010 S	12/2016	Kim et al.	
D775,049 S	12/2016	Scheer et al.	
D775,549 S	1/2017	Karras	
D775,554 S	1/2017	Kapitonov	
D776,020 S	1/2017	Kapitonov	
D776,581 S	1/2017	Pevovar et al.	
D776,583 S	1/2017	Scheer et al.	
D776,841 S	1/2017	Kozub et al.	
D776,843 S	1/2017	McCabe et al.	
D776,846 S	1/2017	Willett et al.	
D777,359 S	1/2017	Kozub et al.	
D777,360 S	1/2017	Kozub et al.	
D777,361 S	1/2017	Kozub et al.	
D777,604 S	1/2017	McNerney	
D777,605 S	1/2017	Ferlazzo et al.	
D777,620 S	1/2017	Pevovar et al.	
D777,621 S	1/2017	Kim	
D777,622 S	1/2017	Kozub et al.	
D777,628 S	1/2017	Kozub et al.	
D777,955 S	1/2017	Willett et al.	
D778,212 S	2/2017	Kozub et al.	
D778,215 S	2/2017	Kozub et al.	
D780,064 S	2/2017	Smith et al.	
D780,067 S	2/2017	Zipfel et al.	
D780,068 S	2/2017	Whitla et al.	
D780,077 S	2/2017	Kim et al.	
D780,081 S	2/2017	Lee	
D780,084 S	2/2017	Scheer et al.	
D780,631 S	3/2017	Kozub et al.	
D780,644 S	3/2017	Kim et al.	
D781,184 S	3/2017	Thole et al.	
D781,192 S	3/2017	Kozub et al.	
D782,379 S	3/2017	Wassell	

(56)

References Cited

U.S. PATENT DOCUMENTS

D783,482 S	4/2017	Smith et al.	D798,204 S	9/2017	Mainville
D784,213 S	4/2017	Karras	D799,384 S	10/2017	Kozub et al.
D784,223 S	4/2017	Lee	D799,385 S	10/2017	Kozub et al.
D784,226 S	4/2017	Cheng	D799,386 S	10/2017	Kozub et al.
D784,579 S	4/2017	Cheng et al.	D799,728 S	10/2017	Whitla et al.
D784,877 S	4/2017	Lee	D801,236 S	10/2017	Kozub et al.
D784,886 S *	4/2017	Smith D12/196	D801,577 S	10/2017	Ruiz
D785,521 S	5/2017	Smith et al.	D801,882 S	11/2017	Kozub et al.
D786,149 S	5/2017	Pevovar et al.	D802,205 S	11/2017	Ruiz
D786,743 S	5/2017	Smith et al.	D802,478 S	11/2017	Perkins
D786,750 S	5/2017	Lee	D802,491 S	11/2017	Mainville
D787,446 S	5/2017	Cockerill	D802,496 S	11/2017	Mainville
D787,984 S	5/2017	Fang	D802,502 S	11/2017	McMahan
D787,988 S	5/2017	Lee	D803,727 S	11/2017	Noone et al.
D787,989 S	5/2017	Kozub et al.	D803,731 S	11/2017	Zipfel
D787,990 S	5/2017	Kozub et al.	D804,370 S	12/2017	Kozub et al.
D787,992 S	5/2017	Lee	D804,371 S	12/2017	Whitla et al.
D787,993 S	5/2017	McCabe et al.	D804,372 S	12/2017	Kozub
D788,001 S	5/2017	Lee	D804,378 S	12/2017	Perkins
D788,641 S	6/2017	Arnold	D804,379 S	12/2017	McMahan
D788,644 S	6/2017	Mueller	D805,006 S	12/2017	Nakamura
D788,645 S	6/2017	Mueller	D805,013 S	12/2017	Whitla
D789,250 S	6/2017	Arnold	D805,014 S	12/2017	Zipfel
D789,260 S	6/2017	Smith	D805,441 S	12/2017	Karras
D789,575 S	6/2017	Willett	D805,964 S	12/2017	Whitla
D789,841 S	6/2017	Lee	D805,965 S	12/2017	Davis
D789,849 S	6/2017	Lee	D805,966 S	12/2017	Perkins
D791,018 S	7/2017	Mylenek	D805,985 S	12/2017	Nakamura
D791,644 S	7/2017	Fang	D807,232 S	1/2018	Bailie
D792,290 S	7/2017	Smith et al.	D807,239 S	1/2018	Perkins
D792,293 S	7/2017	McCabe et al.	D807,240 S	1/2018	Perkins
D792,294 S	7/2017	McCabe et al.	D807,241 S	1/2018	Perkins
D792,295 S	7/2017	McCabe et al.	D809,442 S	2/2018	Zipfel et al.
D792,815 S	7/2017	Kozub	D811,269 S	2/2018	Thompson et al.
D792,816 S	7/2017	Kozub	D811,287 S *	2/2018	Bucher D12/169
D793,290 S	8/2017	Kozub	D811,942 S	3/2018	Jacob
D793,292 S	8/2017	Lee	D811,957 S	3/2018	Whitla et al.
D793,293 S	8/2017	Lee et al.	D811,958 S	3/2018	Zipfel et al.
D793,294 S	8/2017	Lee	D811,959 S	3/2018	Perkins
D793,295 S	8/2017	McCabe et al.	D811,960 S	3/2018	Nakamura
D793,296 S	8/2017	Smith et al.	D811,961 S	3/2018	Sullivan
D793,297 S	8/2017	Smith et al.	D811,962 S	3/2018	Sullivan
D793,299 S	8/2017	Kreig et al.	D811,963 S	3/2018	Sullivan
D793,300 S	8/2017	Kreig et al.	D811,964 S	3/2018	Perkins
D793,301 S	8/2017	Kozub	D811,965 S	3/2018	Moffett et al.
D793,302 S	8/2017	Kozub	D812,525 S	3/2018	Lee
D793,311 S	8/2017	Whitla et al.	D812,526 S	3/2018	Zipfel et al.
D793,590 S	8/2017	Kozub et al.	D812,527 S	3/2018	Perkins
D793,591 S	8/2017	Kozub et al.	D812,528 S	3/2018	Nakamura
D793,917 S	8/2017	Kozub	D812,530 S *	3/2018	Bucher D12/169
D793,918 S	8/2017	Kozub	D813,098 S	3/2018	Thompson et al.
D794,229 S	8/2017	Barry	D813,109 S	3/2018	Zipfel et al.
D794,230 S	8/2017	Kozub	D813,110 S	3/2018	Whitla et al.
D795,747 S	8/2017	Bailie	D813,111 S	3/2018	Sullivan
D795,757 S	8/2017	Pevovar et al.	D813,116 S	3/2018	Park
D795,758 S	8/2017	Karras	D813,117 S	3/2018	Sullivan
D795,759 S	8/2017	Kozub et al.	D813,121 S	3/2018	Swanseger
D795,760 S	8/2017	Kozub et al.	D813,730 S	3/2018	Zipfel et al.
D795,762 S	8/2017	Lee	D813,731 S	3/2018	McMahan
D795,763 S	8/2017	Kozub	D813,732 S	3/2018	Whitla et al.
D796,088 S	8/2017	McCabe et al.	D813,733 S	3/2018	Lee
D796,093 S	8/2017	Mainville	D813,734 S	3/2018	Nakamura
D796,390 S	9/2017	Pevovar et al.	D813,740 S	3/2018	Park
D797,537 S	9/2017	Cooper et al.	D813,741 S	3/2018	Perkins
D797,603 S	9/2017	Noone et al.	D813,742 S	3/2018	McMahan et al.
D797,614 S	9/2017	Lee	D813,743 S	3/2018	Lee
D797,616 S	9/2017	Lee	D813,744 S	3/2018	Whitla et al.
D797,624 S	9/2017	Nakamura	D813,748 S	3/2018	Kim
D797,625 S	9/2017	Perkins	D813,753 S	3/2018	Loeb
D797,631 S	9/2017	Pevovar et al.	D813,754 S	3/2018	Loeb
D797,632 S	9/2017	Zipfel et al.	D813,755 S	3/2018	Loeb
D797,967 S	9/2017	Barry	D813,756 S	3/2018	Loeb
D797,970 S	9/2017	Mainville	D813,757 S	3/2018	Kozub
D797,971 S	9/2017	Mainville	D813,758 S	3/2018	Gonzales
D797,972 S	9/2017	Whitla et al.	D813,759 S	3/2018	Perkins
			D814,369 S	4/2018	Loeb
			D814,982 S	4/2018	Whitla et al.
			D814,983 S	4/2018	Whitla et al.
			D815,570 S	4/2018	McMahan et al.

(56)

References Cited

U.S. PATENT DOCUMENTS

D815,572 S	4/2018	Perkins		D837,424 S	1/2019	Whitla et al.	
D815,573 S	4/2018	Whitla et al.		D838,015 S	1/2019	McMahan et al.	
D815,574 S	4/2018	Mainville		D838,016 S	1/2019	McMahan et al.	
D815,985 S	4/2018	Mueller		D838,390 S	1/2019	McMahan et al.	
D815,993 S	4/2018	Kozub et al.		D838,391 S	1/2019	McMahan et al.	
D815,994 S	4/2018	Nakamura		D838,635 S	*	1/2019	Anderson D12/169
D815,997 S	* 4/2018	Ishii	D12/169	D839,157 S	1/2019	Smith et al.	
D816,003 S	4/2018	Perkins		D839,163 S	1/2019	Pinazzo et al.	
D816,558 S	5/2018	McMahan et al.		D839,164 S	1/2019	Zipfel	
D816,559 S	5/2018	McMahan et al.		D839,460 S	1/2019	Zipfel et al.	
D816,561 S	5/2018	McMahan		D840,068 S	2/2019	Zipfel et al.	
D816,562 S	5/2018	Whitla et al.		D840,069 S	2/2019	Perkins	
D816,563 S	5/2018	McMahan et al.		D840,285 S	2/2019	Mack et al.	
D816,564 S	5/2018	Kim		D840,286 S	2/2019	Mack et al.	
D816,565 S	5/2018	Kim		D840,293 S	2/2019	Koo et al.	
D816,566 S	5/2018	Loeb		D840,302 S	2/2019	O'Donnell et al.	
D817,836 S	5/2018	McMahan et al.		D840,303 S	2/2019	Park Cheng	
D818,156 S	5/2018	Kim et al.		D840,306 S	2/2019	Kozub	
D818,157 S	5/2018	Zipfel et al.		D840,565 S	2/2019	Whitla et al.	
D818,158 S	5/2018	Zipfel et al.		D840,570 S	2/2019	Kim et al.	
D818,159 S	5/2018	Zipfel et al.		D840,571 S	2/2019	Zipfel et al.	
D818,160 S	5/2018	Perkins		D840,572 S	2/2019	Perkins	
D818,401 S	* 5/2018	Bridan	D12/169	D840,885 S	2/2019	Park Cheng	
D818,406 S	5/2018	McMahan et al.		D841,527 S	2/2019	Kozub et al.	
D818,876 S	5/2018	Whitla et al.		D841,532 S	2/2019	Koo et al.	
D818,877 S	5/2018	Nakamura et al.		D841,540 S	2/2019	Koo et al.	
D818,878 S	5/2018	McMahan et al.		D841,541 S	2/2019	Krieg	
D818,892 S	5/2018	Lee		D841,542 S	2/2019	Koo et al.	
D818,893 S	5/2018	Kim		D841,547 S	*	2/2019	Zipfel D12/196
D818,903 S	5/2018	Zipfel et al.		D841,843 S	2/2019	Park	
D818,906 S	5/2018	McMahan		D841,844 S	2/2019	Perkins	
D818,907 S	5/2018	Whitla et al.		D841,845 S	2/2019	Park	
D818,915 S	5/2018	Kozub et al.		D842,178 S	3/2019	Pinazzo et al.	
D818,922 S	5/2018	Whitla et al.		D842,306 S	3/2019	Lindo et al.	
D819,505 S	6/2018	McMahan et al.		D843,023 S	3/2019	Whitla et al.	
D819,519 S	* 6/2018	Whitla	D12/169	D843,024 S	3/2019	Hochmuth	
D821,617 S	6/2018	Perkins		D843,025 S	3/2019	Smith et al.	
D822,550 S	7/2018	Wassell et al.		D843,275 S	3/2019	Koo et al.	
D822,551 S	7/2018	McMahan et al.		D843,280 S	3/2019	Thurber et al.	
D823,188 S	7/2018	Loeb		D843,614 S	3/2019	Whitla et al.	
D823,738 S	7/2018	Kim		D843,616 S	3/2019	Smith et al.	
D823,741 S	7/2018	Kim		D843,617 S	3/2019	Smith et al.	
D823,762 S	7/2018	Loeb		D843,891 S	3/2019	Thompson et al.	
D823,763 S	7/2018	Koo et al.		D843,904 S	3/2019	Kim	
D824,811 S	8/2018	Mainville		D844,184 S	3/2019	Whitla et al.	
D824,812 S	8/2018	Loeb		D844,185 S	3/2019	Hochmuth	
D824,824 S	8/2018	Kim		D844,186 S	3/2019	Smith et al.	
D824,825 S	8/2018	Loeb		D845,184 S	4/2019	Zipfel	
D825,083 S	8/2018	Perkins		D845,186 S	*	4/2019	Koo D12/169
D825,388 S	8/2018	Karras et al.		D845,187 S	4/2019	Pinazzo et al.	
D825,403 S	8/2018	Whitla et al.		D845,188 S	4/2019	Pinazzo et al.	
D826,114 S	8/2018	Smith et al.		D845,189 S	4/2019	Pinazzo et al.	
D826,435 S	8/2018	Kim		D845,190 S	4/2019	Zipfel	
D826,803 S	8/2018	Smith et al.		D845,196 S	4/2019	Kozub	
D827,506 S	9/2018	McMahan et al.		D845,518 S	4/2019	Kozub	
D827,508 S	9/2018	Whitla et al.		D845,519 S	4/2019	Zipfel	
D827,510 S	9/2018	Kim		D846,448 S	4/2019	Loeb	
D827,527 S	9/2018	Loeb		D846,457 S	4/2019	Koo et al.	
D828,246 S	9/2018	Loeb		D846,458 S	4/2019	Mack et al.	
D828,261 S	9/2018	Moffett et al.		D846,769 S	4/2019	Koo et al.	
D828,935 S	9/2018	Hochmuth		D846,770 S	4/2019	Kozub	
D829,143 S	* 9/2018	McMahan	D12/196	D846,771 S	4/2019	Zipfel	
D829,622 S	10/2018	Jacob		D846,772 S	4/2019	Pinazzo et al.	
D830,241 S	10/2018	Kozub		D847,027 S	4/2019	Loeb	
D830,242 S	10/2018	Zipfel		D847,028 S	4/2019	Loeb	
D830,252 S	10/2018	Swanseger		D847,038 S	4/2019	Loeb	
D830,258 S	10/2018	McMahan et al.		D847,041 S	4/2019	Blanski et al.	
D830,261 S	10/2018	Jacob		D847,042 S	4/2019	Pinazzo et al.	
D830,589 S	10/2018	Henriques		D847,043 S	4/2019	Kozub	
D832,752 S	11/2018	Lee		D847,044 S	4/2019	Zipfel	
D833,342 S	* 11/2018	Anderson	D12/169	D847,045 S	4/2019	Whitla et al.	
D835,003 S	12/2018	Thompson et al.		D847,046 S	4/2019	Whitla et al.	
D835,012 S	12/2018	Smith et al.		D847,047 S	4/2019	Krieg et al.	
D837,105 S	1/2019	Loeb		D847,390 S	4/2019	Koo et al.	
D837,109 S	1/2019	Kozub et al.		D847,391 S	4/2019	Pinazzo et al.	
				D847,392 S	4/2019	Zipfel	
				D847,699 S	5/2019	Kozub	
				D847,700 S	5/2019	Kozub	
				D847,701 S	5/2019	Kozub	

(56)

References Cited

U.S. PATENT DOCUMENTS

D847,702 S	5/2019	Zipfel	D856,204 S	8/2019	Kapitonov
D847,703 S	5/2019	Kozub	D856,206 S	8/2019	De Leon
D847,704 S	5/2019	Zipfel	D856,242 S	8/2019	Blanski et al.
D847,705 S	5/2019	Zipfel	D856,864 S	8/2019	Kapitonov
D847,707 S	5/2019	Park Cheng et al.	D856,874 S	8/2019	Kozub
D847,714 S	5/2019	Mack et al.	D856,875 S	8/2019	Kozub
D848,315 S	5/2019	Koo et al.	D856,876 S	8/2019	Kapitonov
D848,318 S	5/2019	McMahan et al.	D857,260 S	8/2019	Kil et al.
D848,320 S	5/2019	Pinazzo et al.	D857,567 S	8/2019	Blanski et al.
D848,322 S	5/2019	Mack et al.	D857,936 S	8/2019	Kil et al.
D848,323 S	5/2019	Mack et al.	D857,938 S	8/2019	Blanski et al.
D848,324 S	5/2019	Thurber et al.	D857,939 S	8/2019	Kozub
D848,325 S	5/2019	Thurber et al.	D857,940 S	8/2019	Park
D848,647 S	5/2019	Kozub	D857,941 S	8/2019	Pinazzo et al.
D848,908 S	5/2019	Krieg	D857,942 S	8/2019	Perkins
D848,909 S	5/2019	Lee	D857,943 S	8/2019	Hochmuth
D848,911 S *	5/2019	De Leon D12/169	D857,944 S	8/2019	Pinazzo et al.
D848,915 S	5/2019	Izard	D857,945 S	8/2019	Smith et al.
D849,627 S	5/2019	Zipfel	D857,946 S	8/2019	Smith et al.
D849,629 S	5/2019	De Leon	D857,947 S	8/2019	Koo et al.
D849,630 S	5/2019	De Leon	D857,948 S	8/2019	Koo et al.
D850,341 S	6/2019	Riggs et al.	D857,949 S	8/2019	Smith et al.
D850,989 S	6/2019	Kozub	D857,950 S	8/2019	Zipfel
D851,002 S	6/2019	Kozub	D857,951 S	8/2019	Whitla et al.
D851,541 S	6/2019	Pinazzo	D857,952 S	8/2019	Smith et al.
D851,542 S	6/2019	Mack	D858,373 S	9/2019	Blanski et al.
D851,547 S	6/2019	Mack et al.	D858,377 S	9/2019	Riggs et al.
D851,548 S	6/2019	Mack et al.	D858,813 S	9/2019	Datta
D851,549 S	6/2019	Mack et al.	D858,814 S	9/2019	Burns
D851,550 S	6/2019	Mack et al.	D858,817 S	9/2019	Henriques
D851,551 S	6/2019	Mack et al.	D858,818 S	9/2019	McMahan et al.
D851,552 S	6/2019	Mack et al.	D858,819 S	9/2019	McMahan et al.
D851,555 S	6/2019	Whitla et al.	D858,820 S	9/2019	McMahan et al.
D851,556 S	6/2019	Thurber et al.	D858,821 S	9/2019	Park
D851,557 S	6/2019	Thurber et al.	D858,822 S	9/2019	Whitla et al.
D851,558 S	6/2019	Thurber et al.	D858,823 S	9/2019	Zipfel
D851,559 S	6/2019	Thurber et al.	D858,824 S	9/2019	Pinazzo et al.
D851,560 S	6/2019	Yong et al.	D859,229 S	9/2019	Karras et al.
D851,561 S	6/2019	Yong et al.	D859,230 S	9/2019	Parkinson et al.
D852,093 S	6/2019	Kozub	D859,231 S	9/2019	Wilkins et al.
D852,094 S	6/2019	Zipfel	D859,232 S	9/2019	Izard et al.
D852,096 S	6/2019	Kozub	D859,233 S	9/2019	Izard et al.
D852,099 S	6/2019	Loeb	D859,237 S	9/2019	Koo et al.
D852,389 S	6/2019	Koo et al.	D859,238 S	9/2019	Smith et al.
D852,393 S	6/2019	Whitla et al.	D859,239 S	9/2019	Sullivan et al.
D853,903 S	7/2019	Loeb	D859,246 S	9/2019	Thurber et al.
D853,904 S	7/2019	Koo et al.	D859,248 S	9/2019	Wilkins et al.
D853,924 S	7/2019	Riggs et al.	D859,252 S	9/2019	Krieg
D854,462 S	7/2019	Lee	D859,253 S	9/2019	Izard
D854,471 S	7/2019	Lee	D859,254 S	9/2019	Izard
D854,977 S	7/2019	Parkinson et al.	D859,707 S	9/2019	McMahan et al.
D854,979 S	7/2019	Krieg et al.	D859,708 S	9/2019	Kozub
D854,988 S	7/2019	Krieg	D859,709 S	9/2019	Zipfel
D854,991 S	7/2019	Whitla et al.	D860,075 S	9/2019	Riggs et al.
D855,503 S	8/2019	Blanski et al.	D860,076 S	9/2019	Bartels et al.
D855,504 S	8/2019	Lee	D860,077 S	9/2019	Riggs et al.
D855,505 S	8/2019	Thurber et al.	D860,078 S	9/2019	O'Donnell et al.
D855,507 S	8/2019	Blanski et al.	D860,079 S	9/2019	Sullivan et al.
D855,508 S	8/2019	Wilkins et al.	D860,085 S	9/2019	Koo et al.
D855,509 S	8/2019	Wilkins	D860,489 S	9/2019	Henriques
D855,515 S	8/2019	Riggs et al.	D860,490 S	9/2019	Henriques
D855,518 S	8/2019	Whitla et al.	D870,620 S *	12/2019	Hallgren D12/184
D855,520 S	8/2019	Parkinson	D890,646 S *	7/2020	Owens D12/169
D855,523 S	8/2019	Perkins	D902,800 S *	11/2020	Gay D12/169
D855,524 S	8/2019	Lee	D904,943 S *	12/2020	Wraith D12/169
D856,201 S	8/2019	Blanski et al.	D920,202 S *	5/2021	Feng D12/196
			D922,284 S *	6/2021	Feng D12/196

* cited by examiner

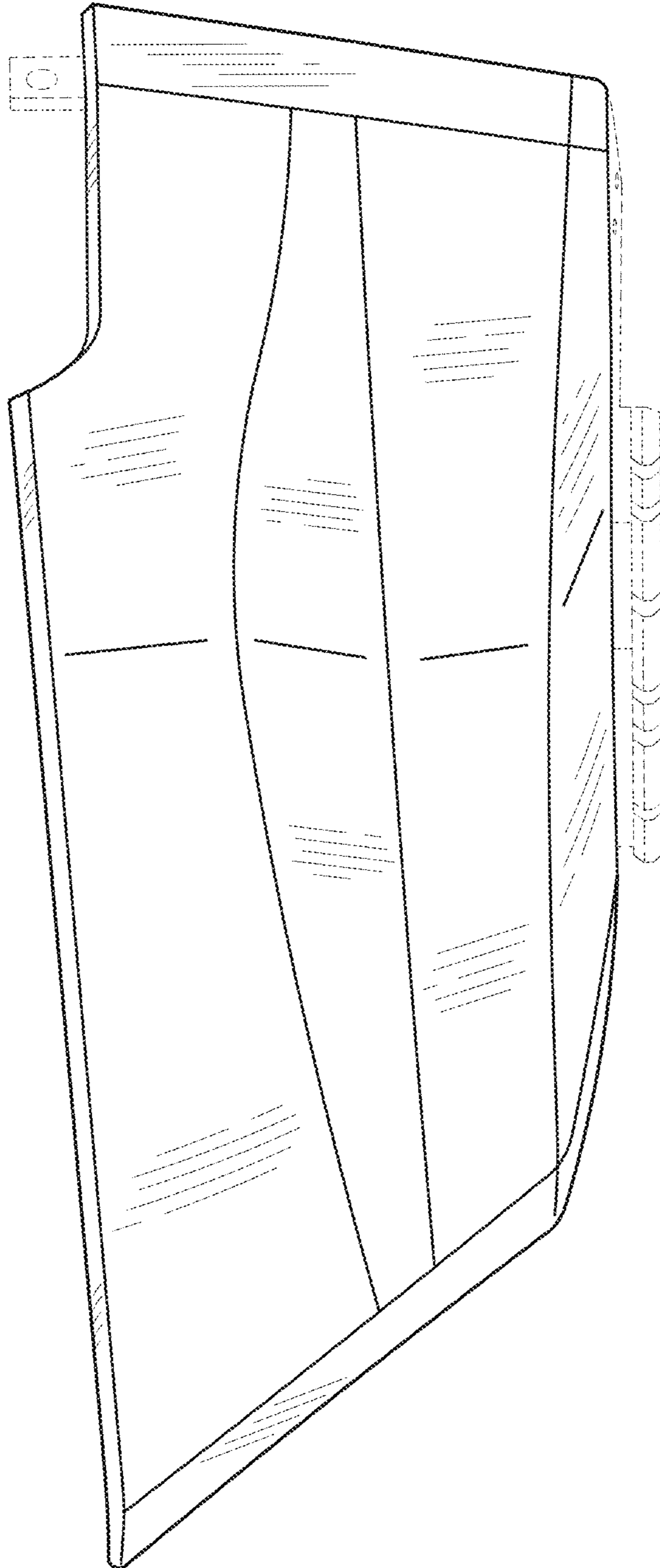

FIG-1

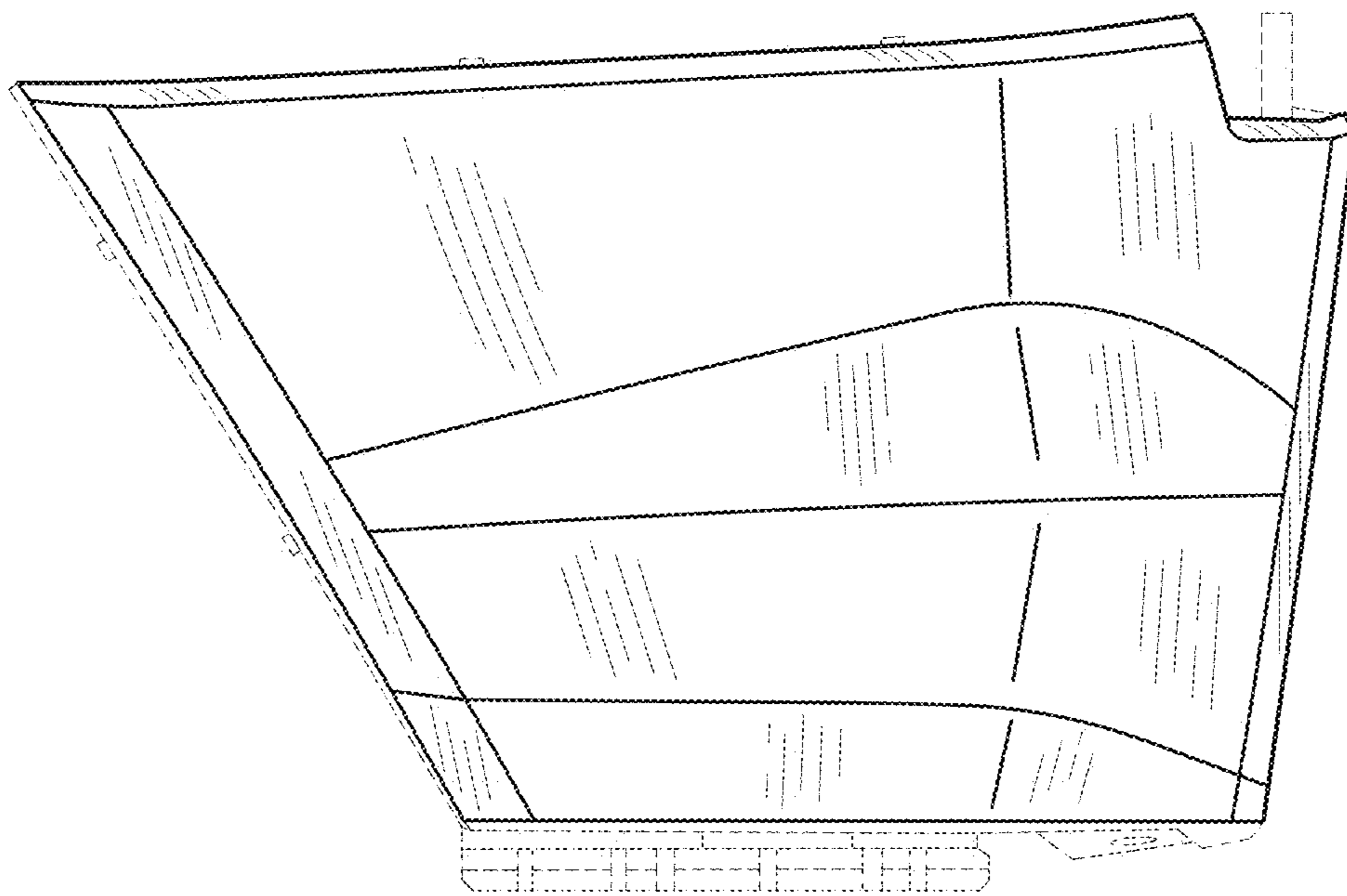

FIG - 2

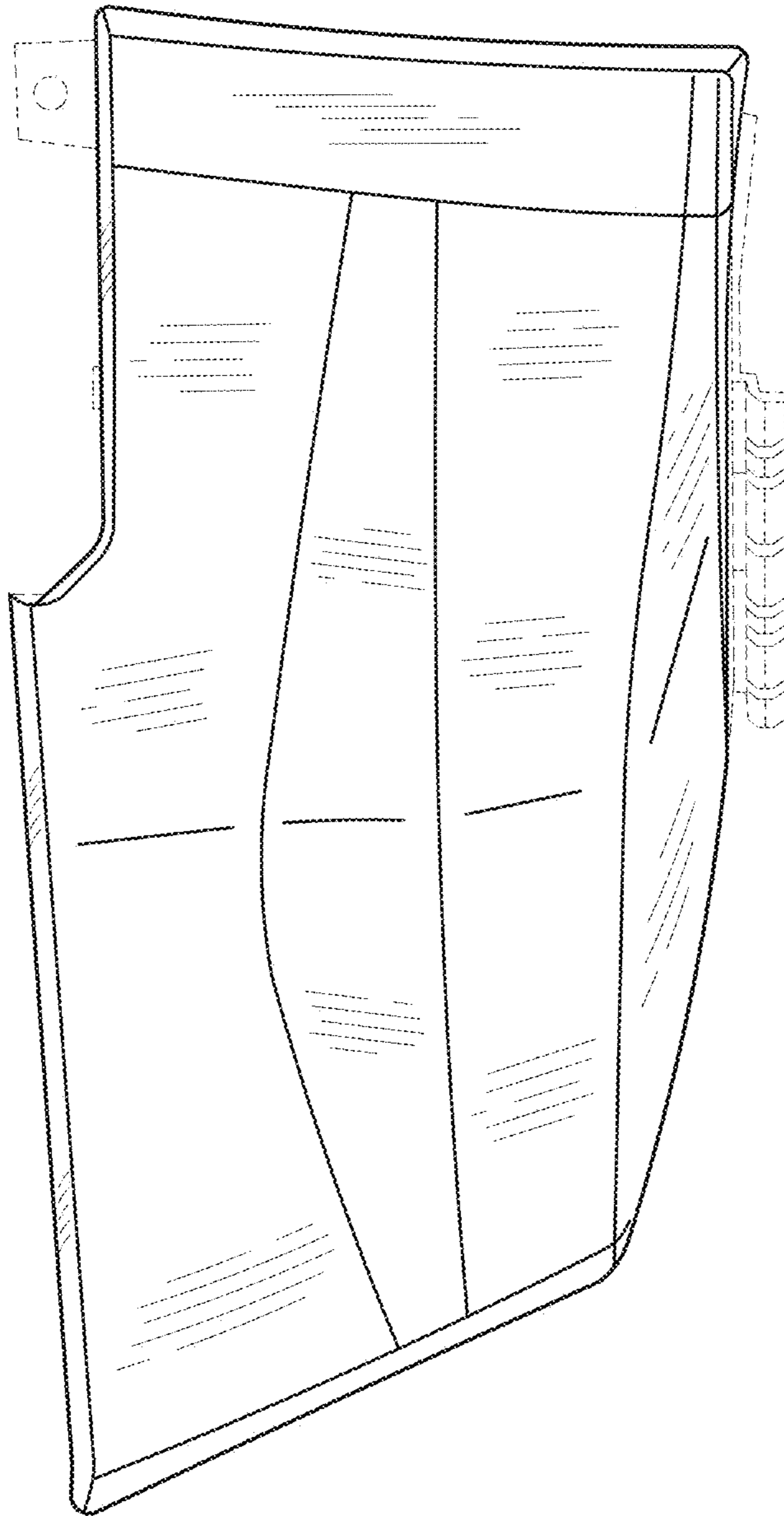

FIG - 3

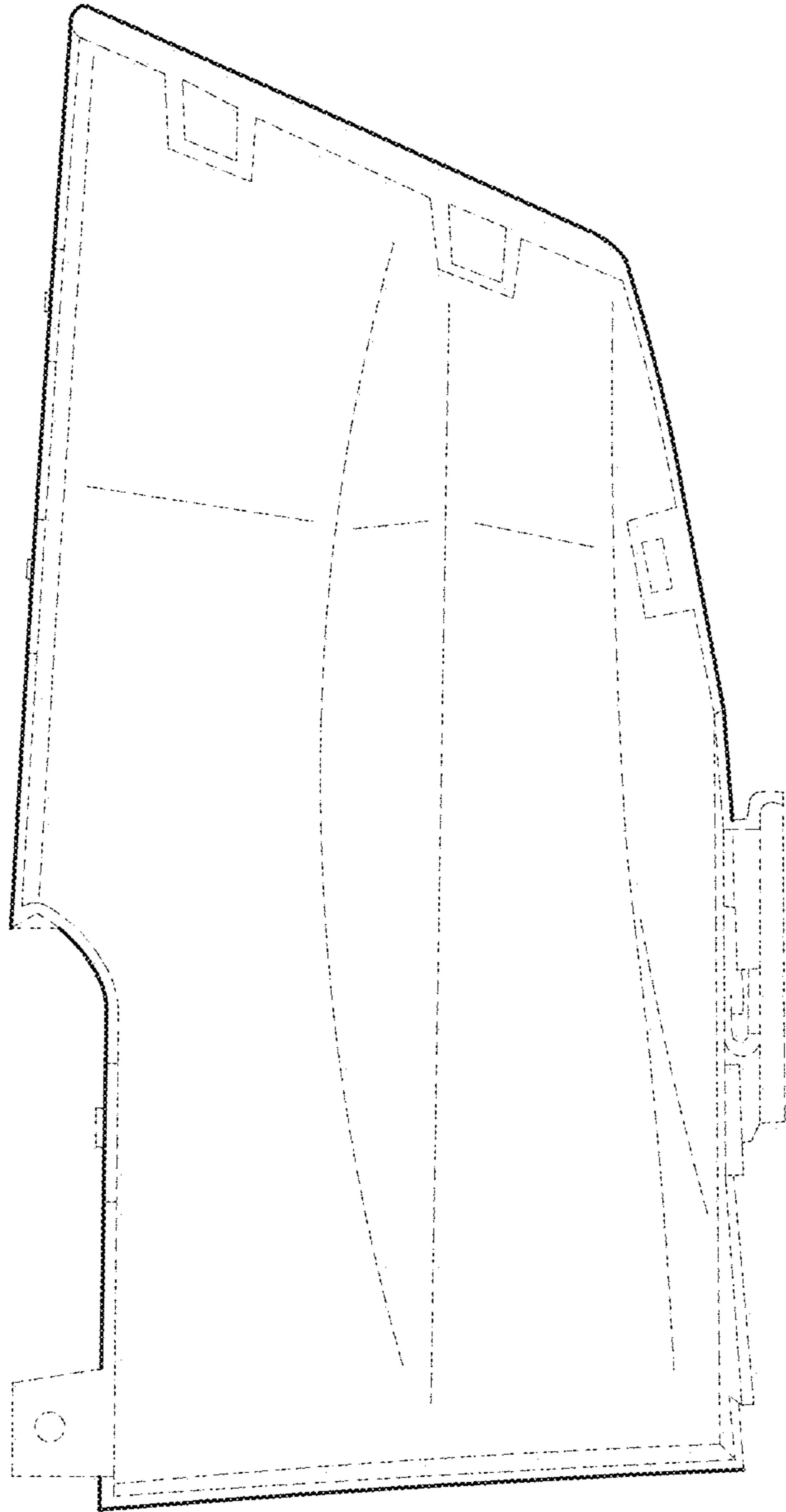

FIG - 4

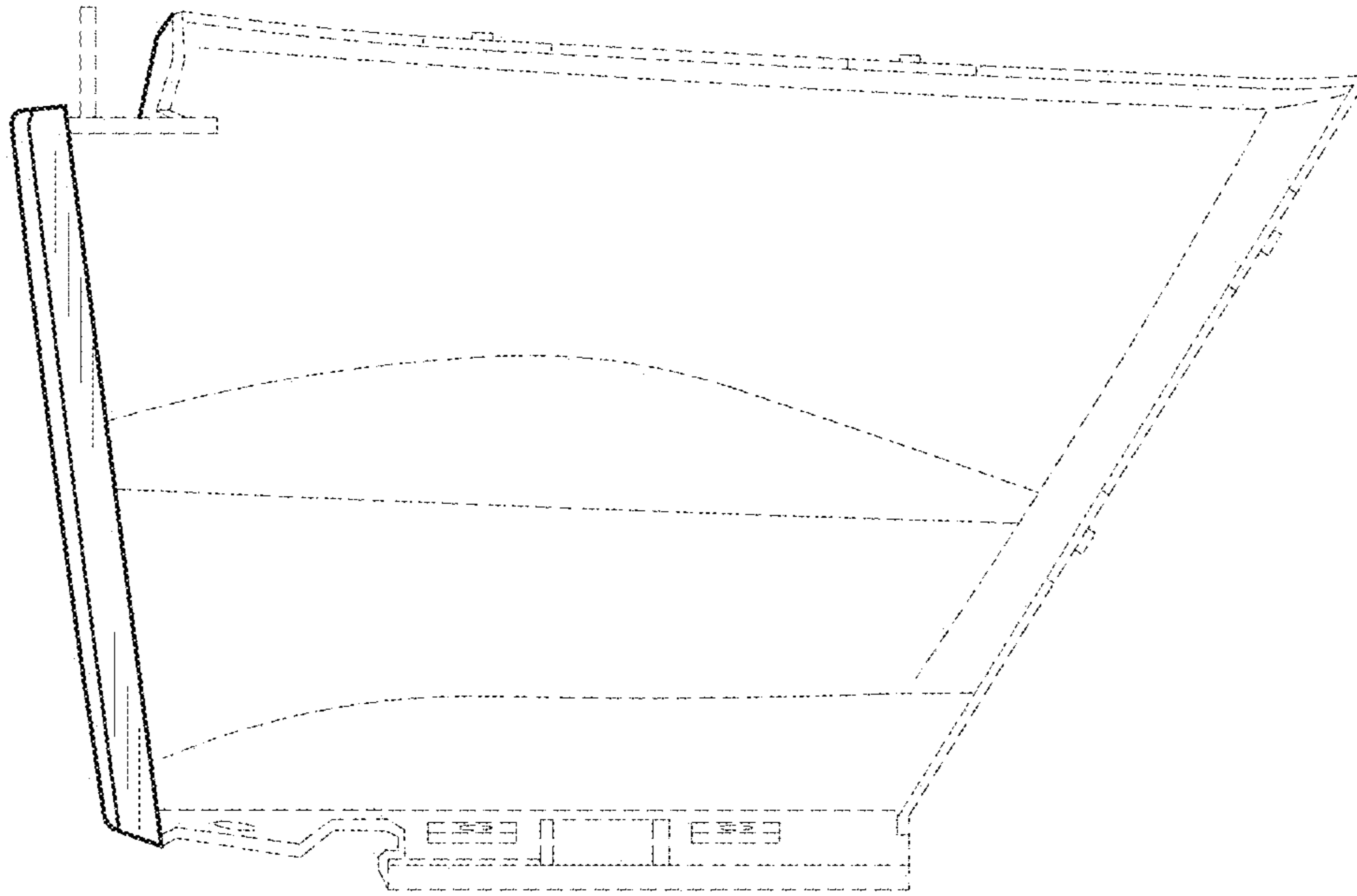

FIG - 5

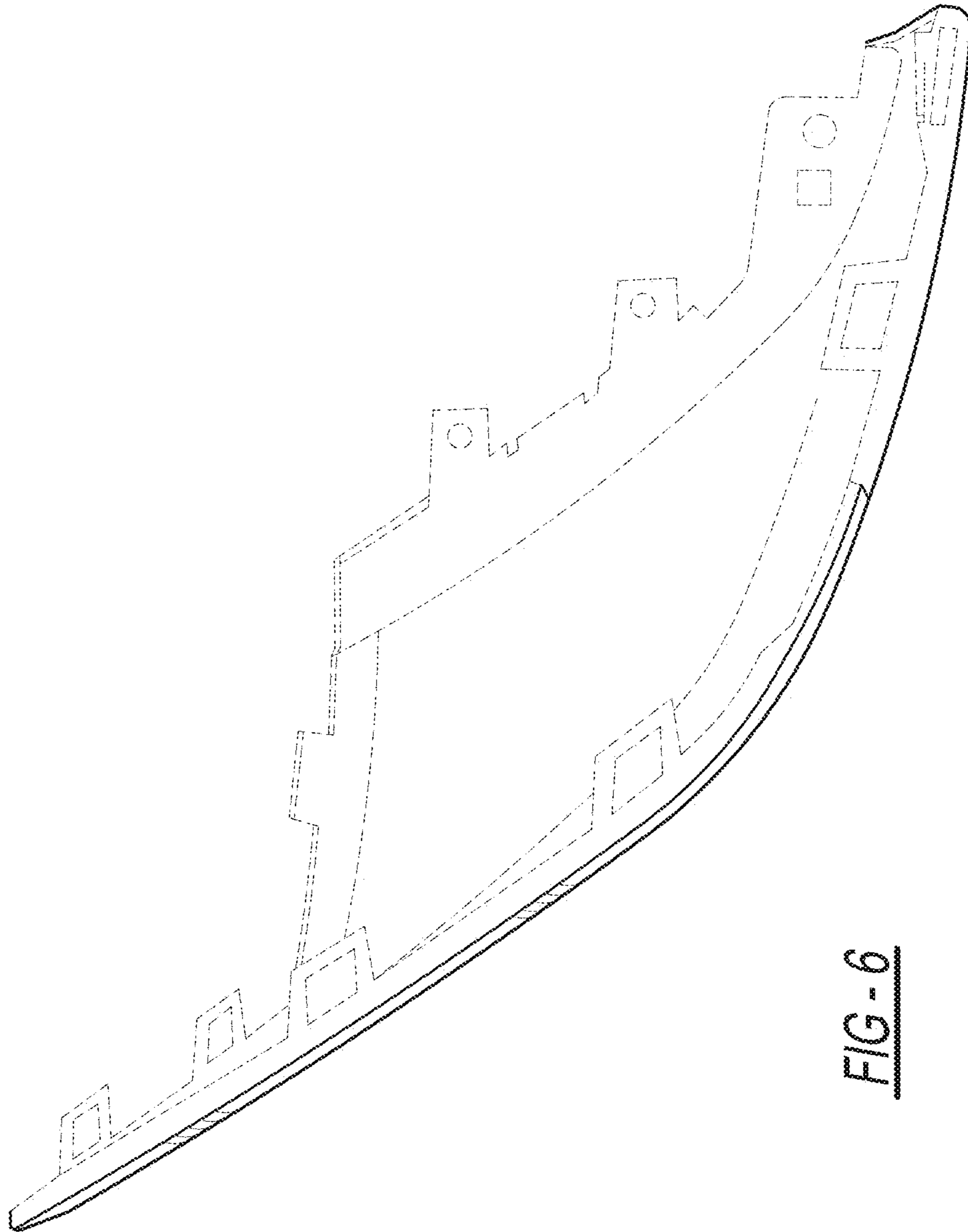

FIG - 6

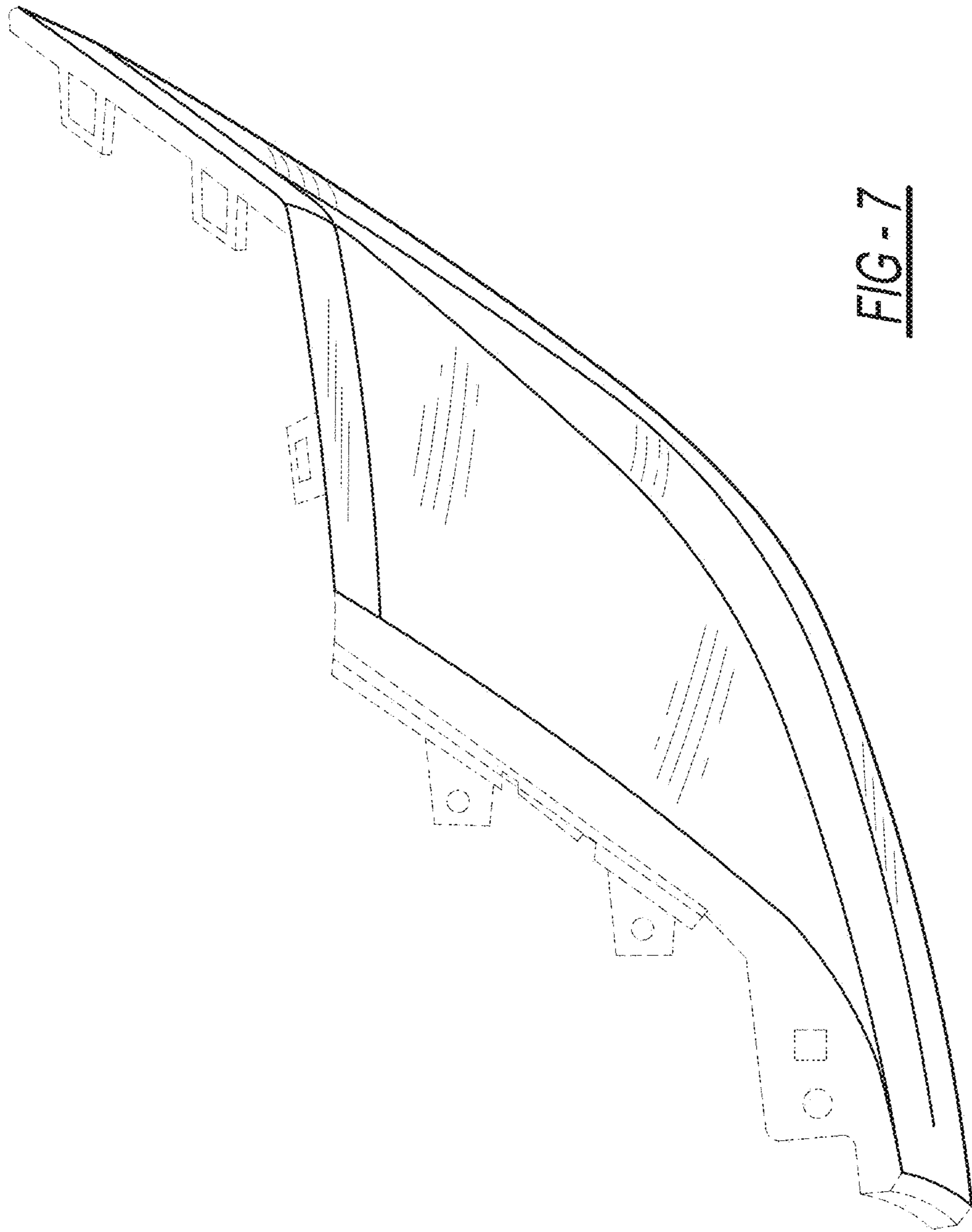

FIG-7