



US00D930467S

(12) **United States Design Patent** (10) **Patent No.:** **US D930,467 S**
Althaus et al. (45) **Date of Patent:** **** Sep. 14, 2021**

- (54) **CONTAINER**
- (71) Applicant: **Société des Produits Nestlé S.A.,**
Vevey (CH)
- (72) Inventors: **Lauren Althaus**, St. Louis, MO (US);
Yukihiro Urushidani, Webster Groves,
MO (US); **Jason Garvey**, Ofallon, IL
(US); **Graham Hufton**, New York, NY
(US)
- (73) Assignee: **Société des Produits Nestlé S.A.,**
Vevey (CH)
- (**) Term: **15 Years**
- (21) Appl. No.: **29/694,499**
- (22) Filed: **Jun. 11, 2019**
- (51) **LOC (13) Cl.** **09-03**
- (52) **U.S. Cl.**
USPC **D9/425**
- (58) **Field of Classification Search**
USPC D7/400, 601, 608; D9/416, 417, 420,
D9/425-429, 430, 432, 761; 206/499,
206/501, 502, 821; 220/625, 656, 669,
220/670, 674; 229/123.1, 123.2, 125.33,
229/125.35, 400-407, 915, 939
CPC . B65D 1/26; B65D 1/40; B65D 5/243; B65D
81/3453; B65D 2581/34; B65D
2581/3404; B65D 2581/3456
See application file for complete search history.

- D750,973 S * 3/2016 McSweeney D9/756
- D750,974 S * 3/2016 McSweeney D9/756
- D774,402 S 12/2016 McSweeney et al.
- D778,115 S * 2/2017 Strachan D7/553.1
- D785,466 S * 5/2017 Son D9/760
- D793,868 S * 8/2017 Kim D9/756
- 2010/0065562 A1* 3/2010 Vovan B65D 21/0206
220/23.4
- 2016/0114966 A1* 4/2016 Yeh B65D 43/162
206/223

OTHER PUBLICATIONS

Althaus et al., Design U.S. Appl. No. 29/685,694, filed Mar. 29, 2019, 17 pages.

* cited by examiner

Primary Examiner — Janice Patyk

(74) *Attorney, Agent, or Firm* — Finnegan, Henderson, Farabow, Garrett & Dunner, LLP

(57) **CLAIM**

The ornamental design for a container, as shown and described.

DESCRIPTION

FIG. 1 is a top, front, right side perspective view of a container, showing our new design; FIG. 2 is a front elevation view thereof; FIG. 3 is a rear elevation view thereof; FIG. 4 is a left side view thereof; FIG. 5 is a right side view thereof; FIG. 6 is a top plan view thereof; and, FIG. 7 is a bottom plan view thereof.

The broken lines illustrate portions of the container that form no part of the claimed design.

The diagonal broken lines in the middle of the flange on the container in FIGS. 1 and 4-7 are included to show unclaimed seam on the article.

1 Claim, 7 Drawing Sheets

(56) **References Cited**

U.S. PATENT DOCUMENTS

- D448,130 S * 9/2001 Wagner D32/53.1
- D569,193 S * 5/2008 El Ghouyel D7/602
- D713,741 S * 9/2014 Wilmers D9/761
- D740,135 S 10/2015 McSweeney et al.
- D741,201 S 10/2015 McSweeney et al.
- 9,216,849 B2* 12/2015 Pham B65D 43/162

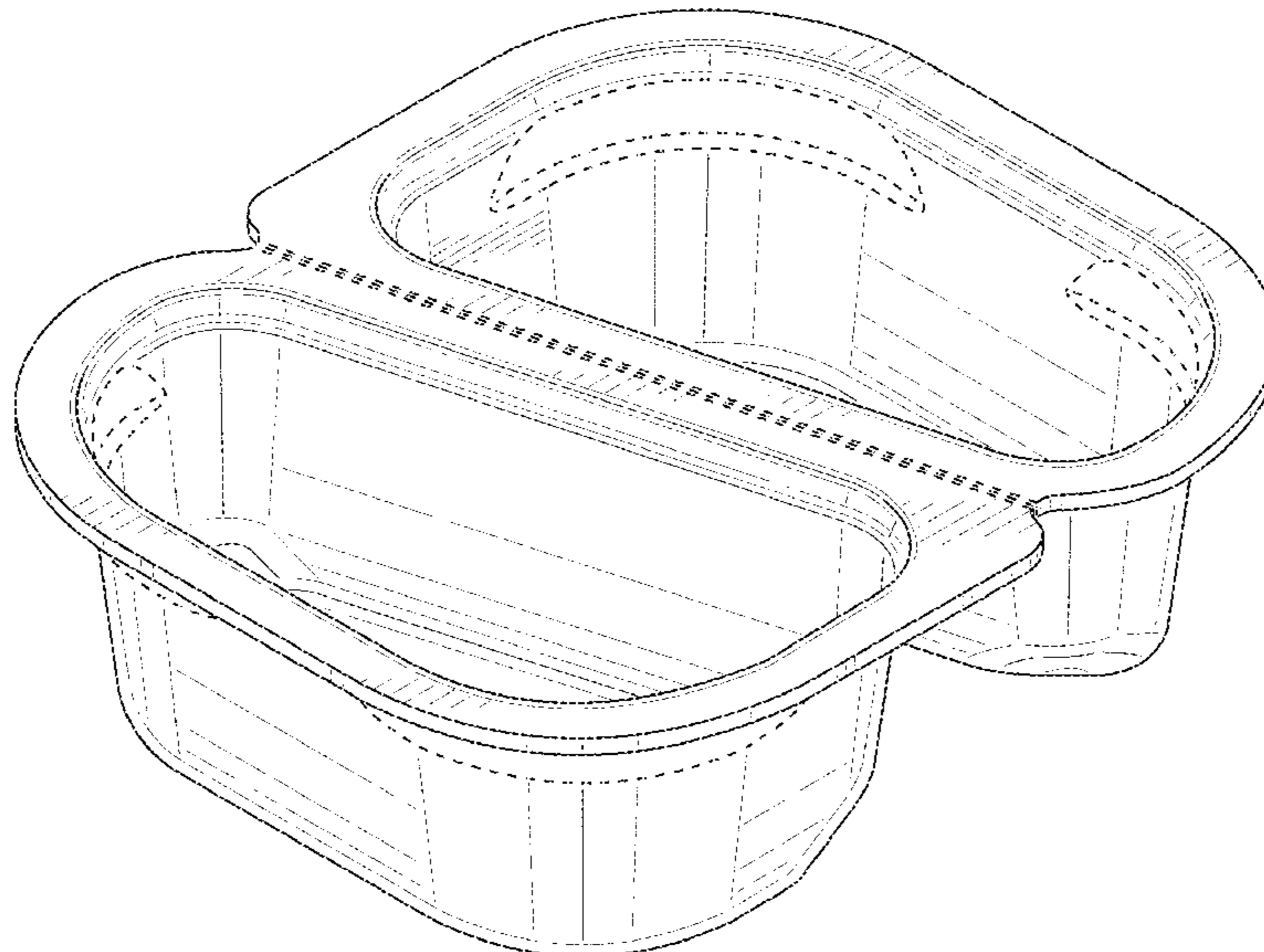

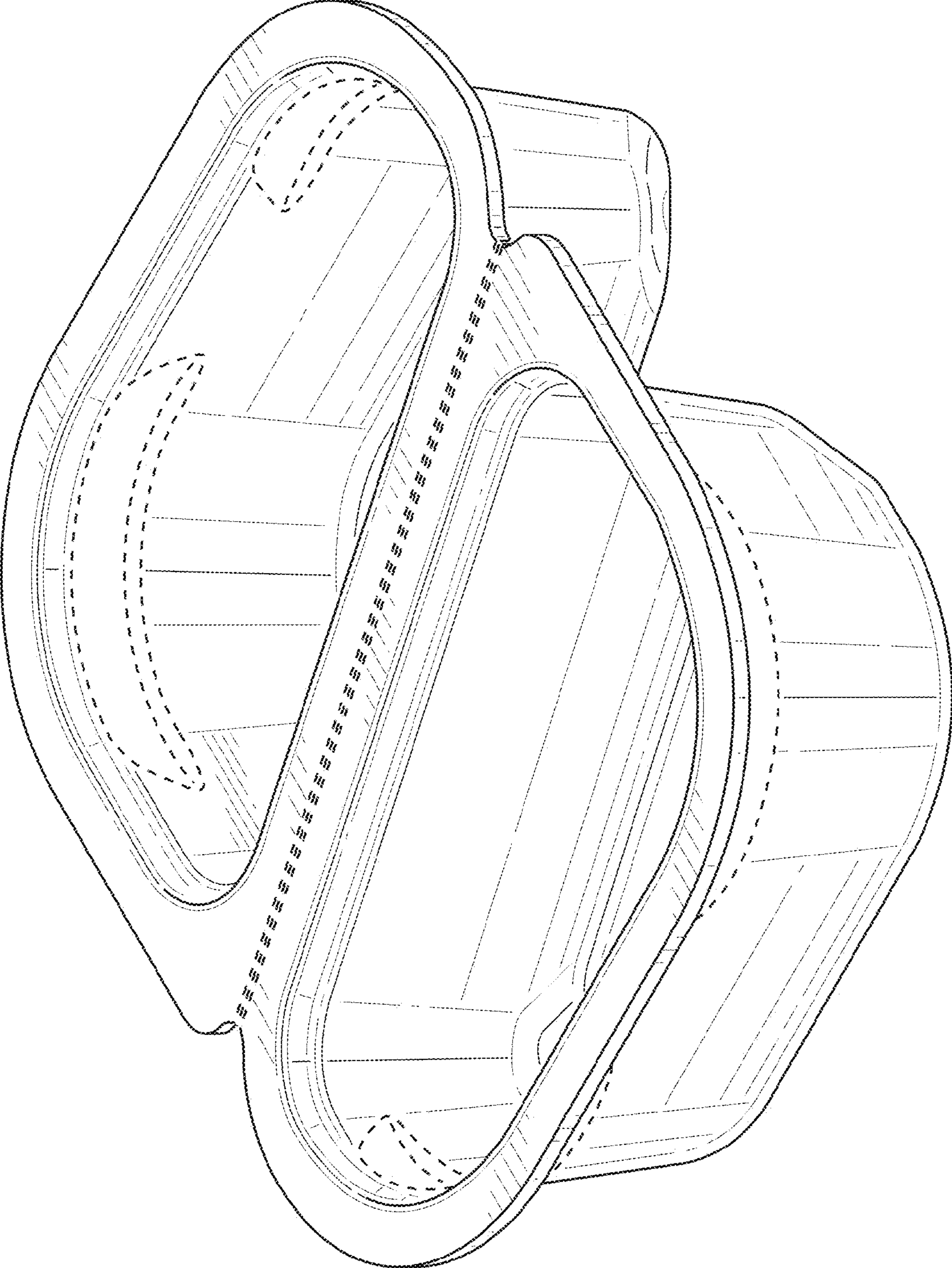

FIG. 1

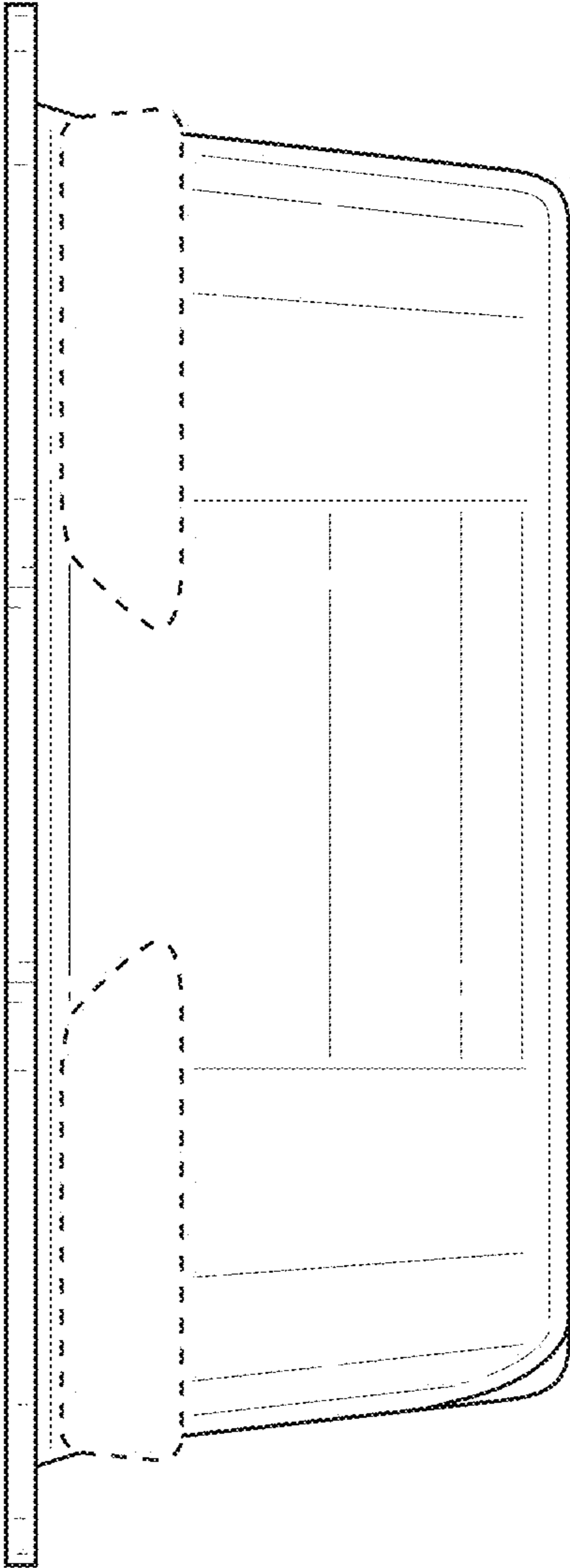

FIG. 2

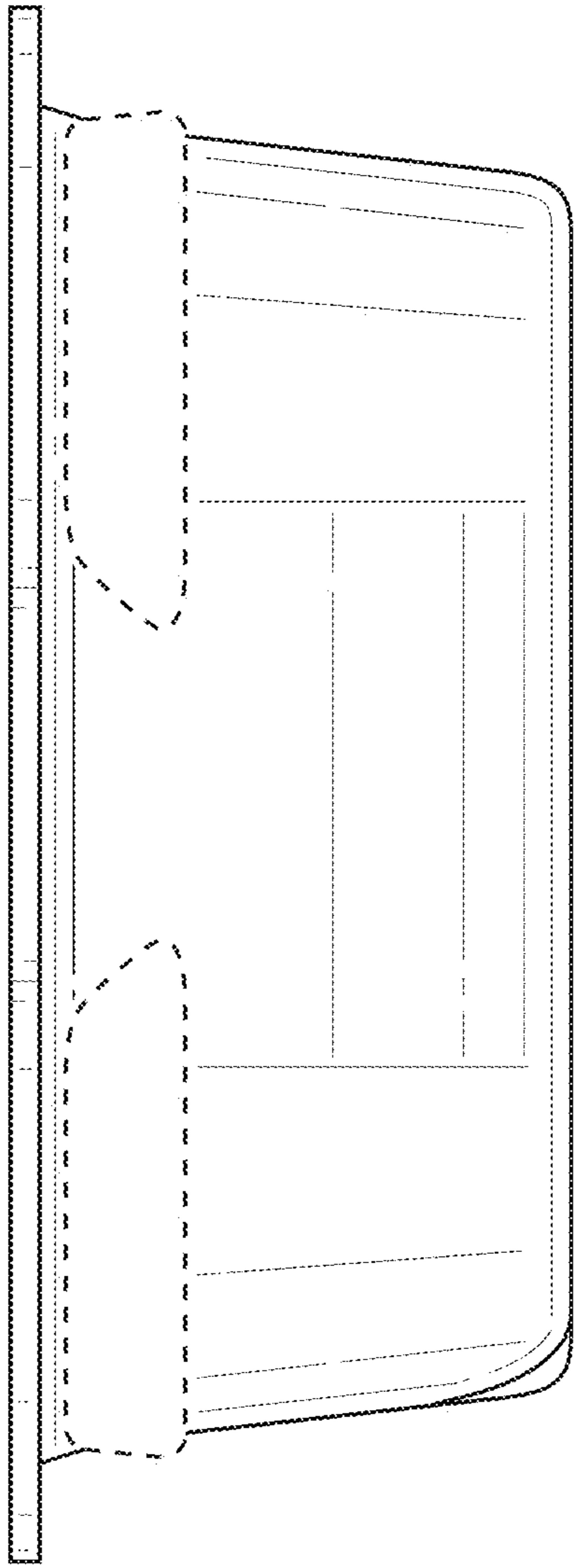

FIG. 3

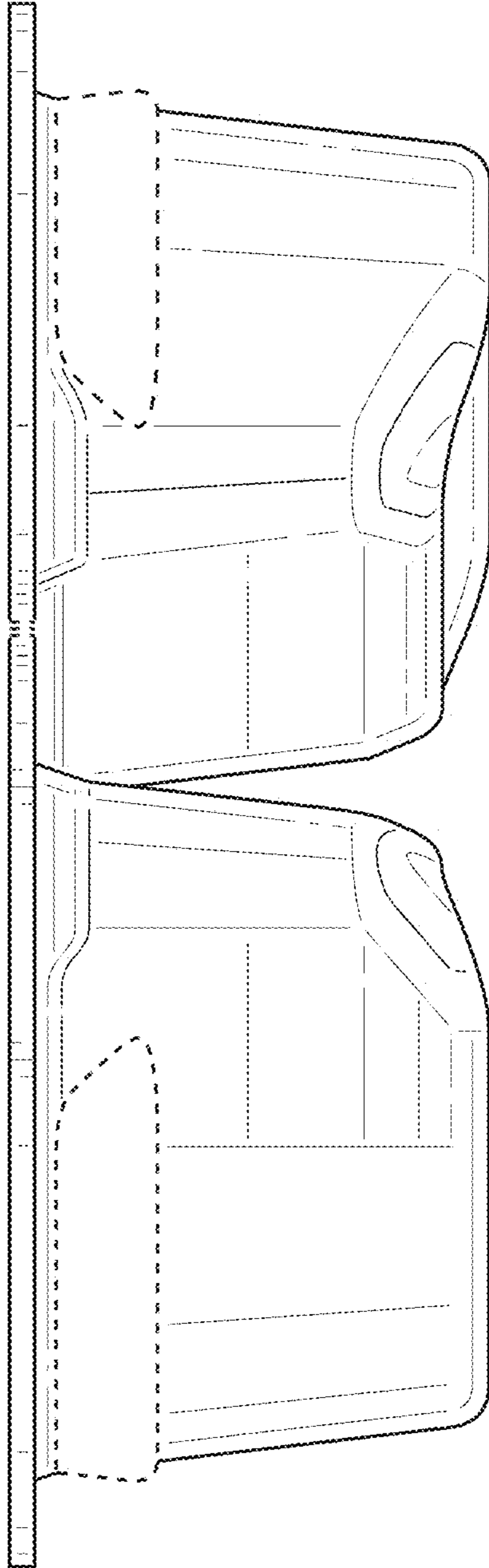

FIG. 4

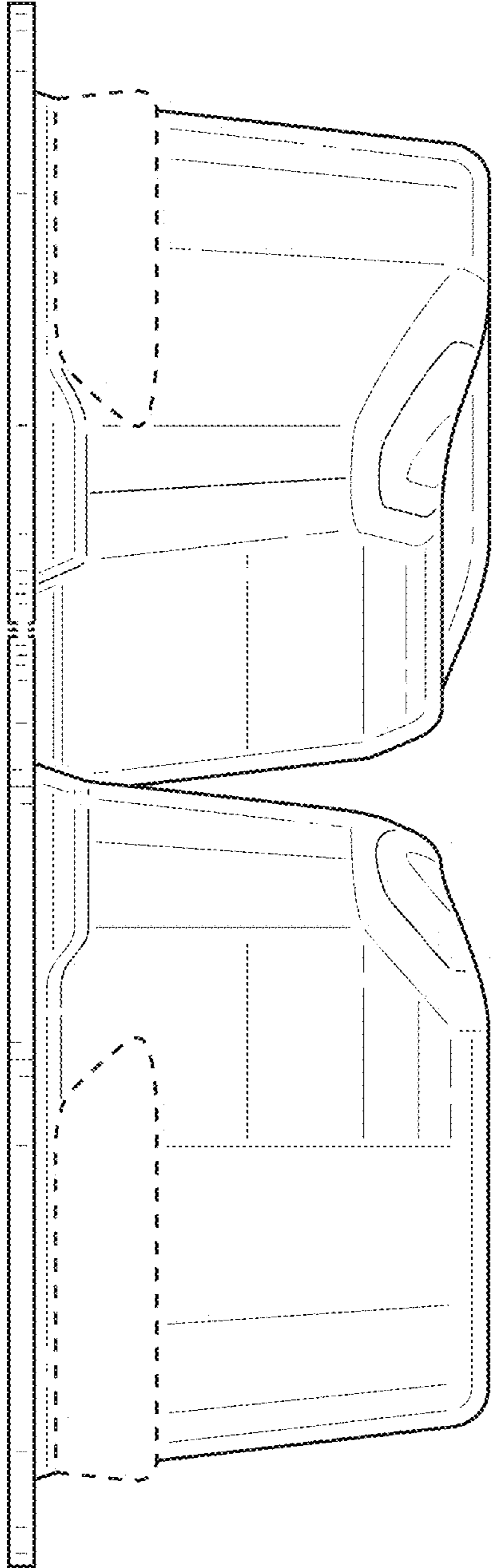

FIG. 5

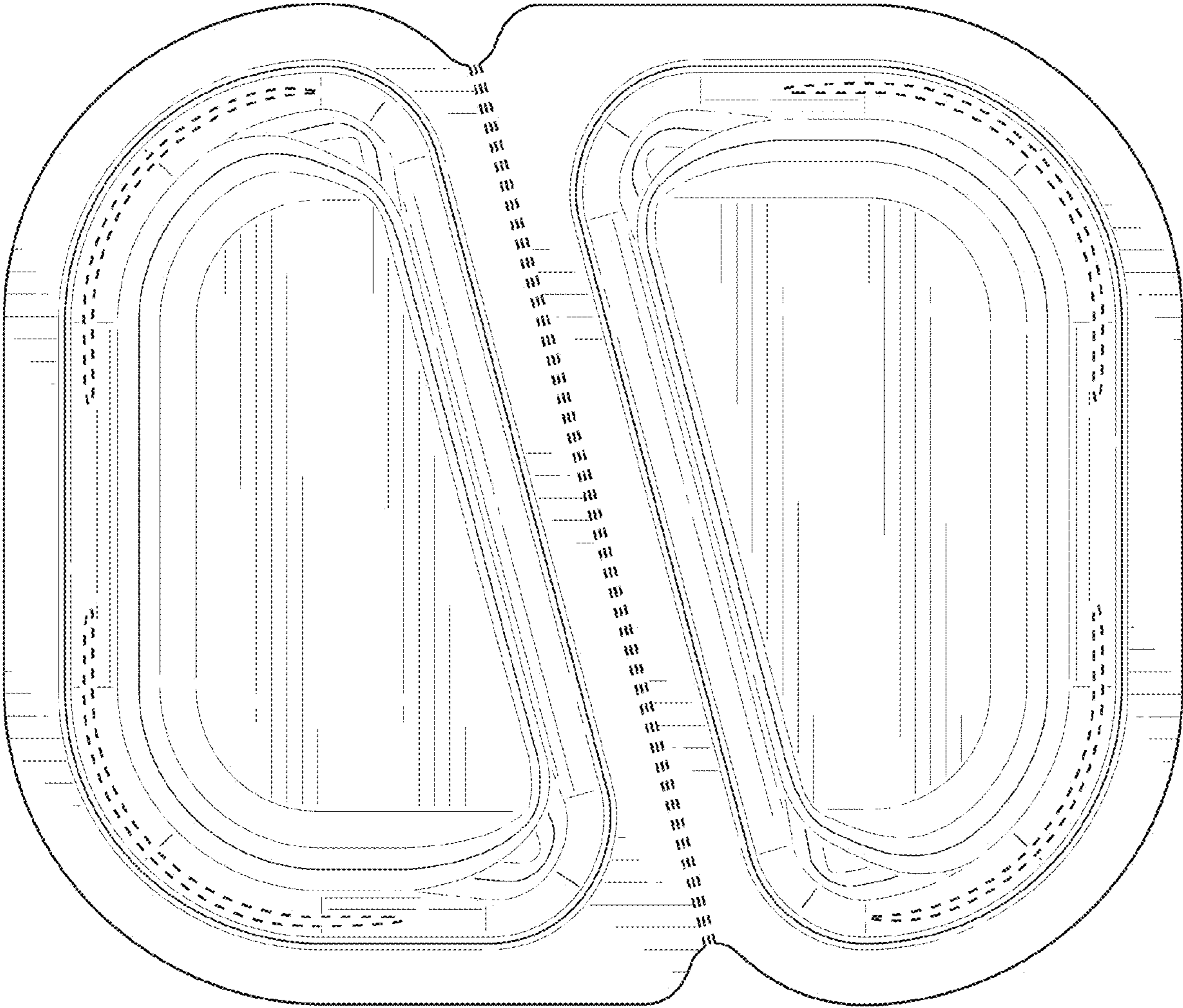

FIG. 6

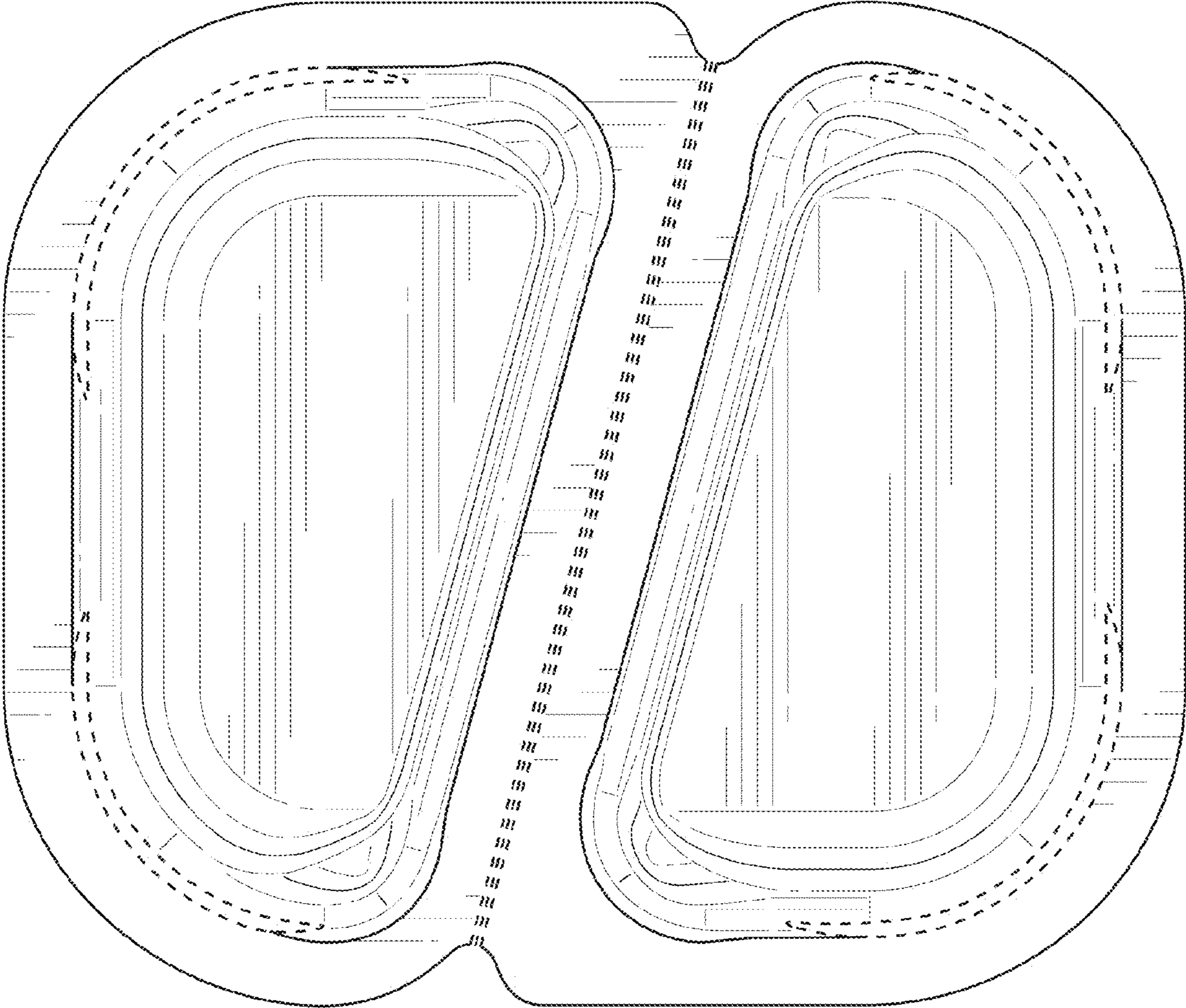

FIG. 7