



US00D930321S

(12) **United States Design Patent** (10) **Patent No.:** **US D930,321 S**
Kreamer (45) **Date of Patent:** **** Sep. 14, 2021**

(54) **PET TREAT**

- (71) Applicant: **Spectrum Brands, Inc.**, Middleton, WI (US)
- (72) Inventor: **Marc Kreamer**, Delray Beach, FL (US)
- (73) Assignee: **Spectrum Brands, Inc.**, Middleton, WI (US)
- (**) Term: **15 Years**
- (21) Appl. No.: **29/675,159**
- (22) Filed: **Dec. 28, 2018**

Related U.S. Application Data

- (60) Continuation of application No. 29/589,598, filed on Jan. 3, 2017, now Pat. No. Des. 836,880, which is a (Continued)

- (51) **LOC (13) Cl.** **01-01**
- (52) **U.S. Cl.**
USPC **D1/125**

- (58) **Field of Classification Search**
USPC D1/100-130, 199; 426/5, 76, 87, 92, 94, 426/95, 99, 101, 103, 104, 108, 134, (Continued)

(56) **References Cited**

U.S. PATENT DOCUMENTS

- 426,506 A * 4/1890 Kuhn A23G 3/54
426/103
- 544,394 A * 8/1895 Stille A23G 3/50
426/104

(Continued)

FOREIGN PATENT DOCUMENTS

- CN 2755968 Y 2/2006
- CN 201207894 3/2009

(Continued)

OTHER PUBLICATIONS

Buffalo Range Treats, "Natural, Grain Free Jerky Kabob Rawhide Chews for Dogs," Retrieved from Internet URL: <http:// buffalo-rangetreats.com/jerky-rawhide/jerky-kabob-rawhide-chews>, 6 pages (Year 2020).

(Continued)

Primary Examiner — Katie Jane Stofko

(74) *Attorney, Agent, or Firm* — Merchant & Gould P.C.

(57) **CLAIM**

The ornamental design for a pet treat, as shown and described.

DESCRIPTION

FIG. 1 is a front, top, and left perspective view of a first embodiment of a pet treat according to the new design; FIG. 2 is a left side elevation view thereof; FIG. 3 is a right side elevation view thereof; FIG. 4 is a front elevation view thereof; FIG. 5 is a rear elevation view thereof; FIG. 6 is a top plan view thereof; FIG. 7 is a bottom plan view thereof; FIG. 8 is a front, top, and left side perspective view of a second embodiment of a pet treat according to the new design; FIG. 9 is a left side elevation view thereof; FIG. 10 is a right side elevation view thereof; FIG. 11 is a front elevation view thereof; FIG. 12 is a rear elevation view thereof; FIG. 13 is a top plan view thereof; and, FIG. 14 is a bottom plan view thereof.

The broken lines shown FIGS. 1-14 illustrate portions of the pet treat that form no part of the claimed design. The striped shade lines and sporadic shade lines shown in FIGS. 8-14 represent a contrasting appearance.

1 Claim, 8 Drawing Sheets

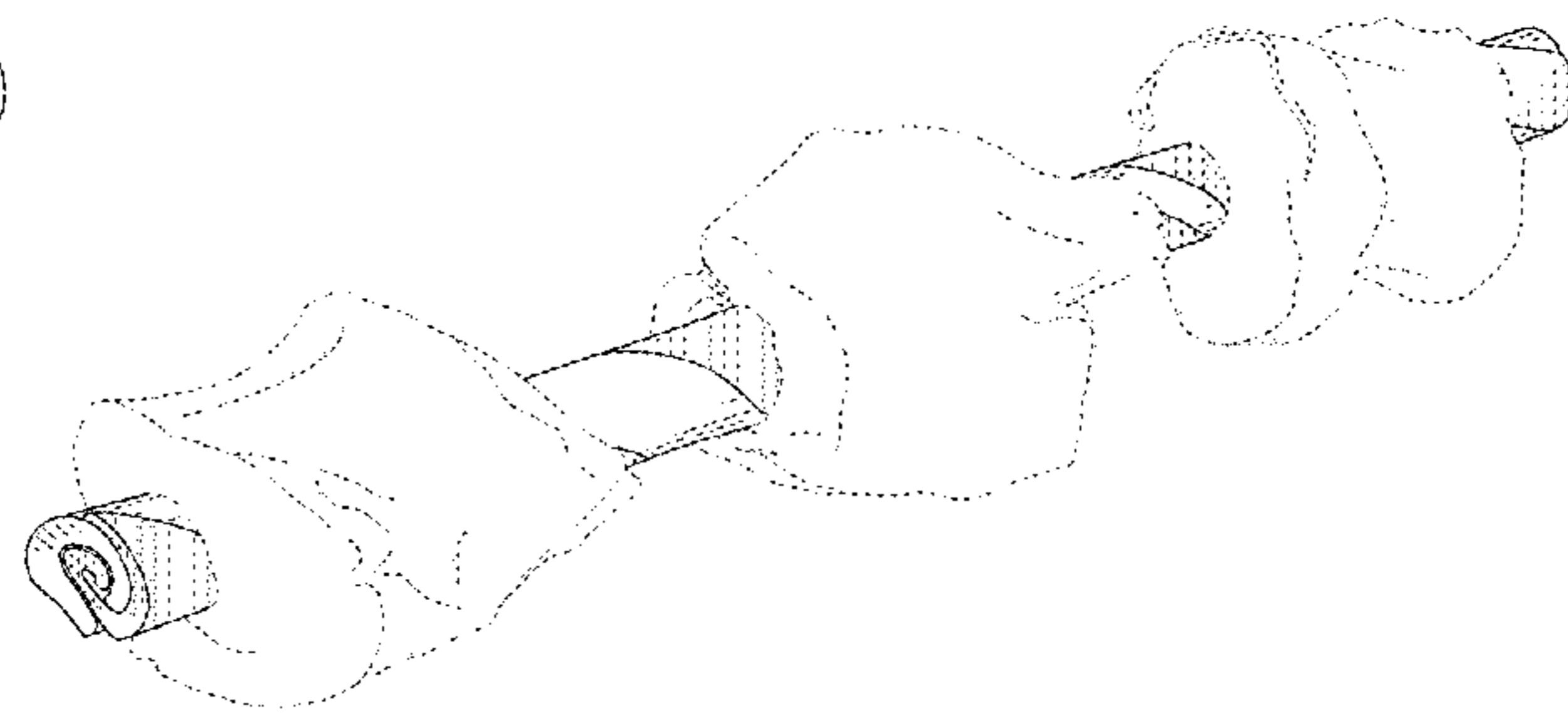
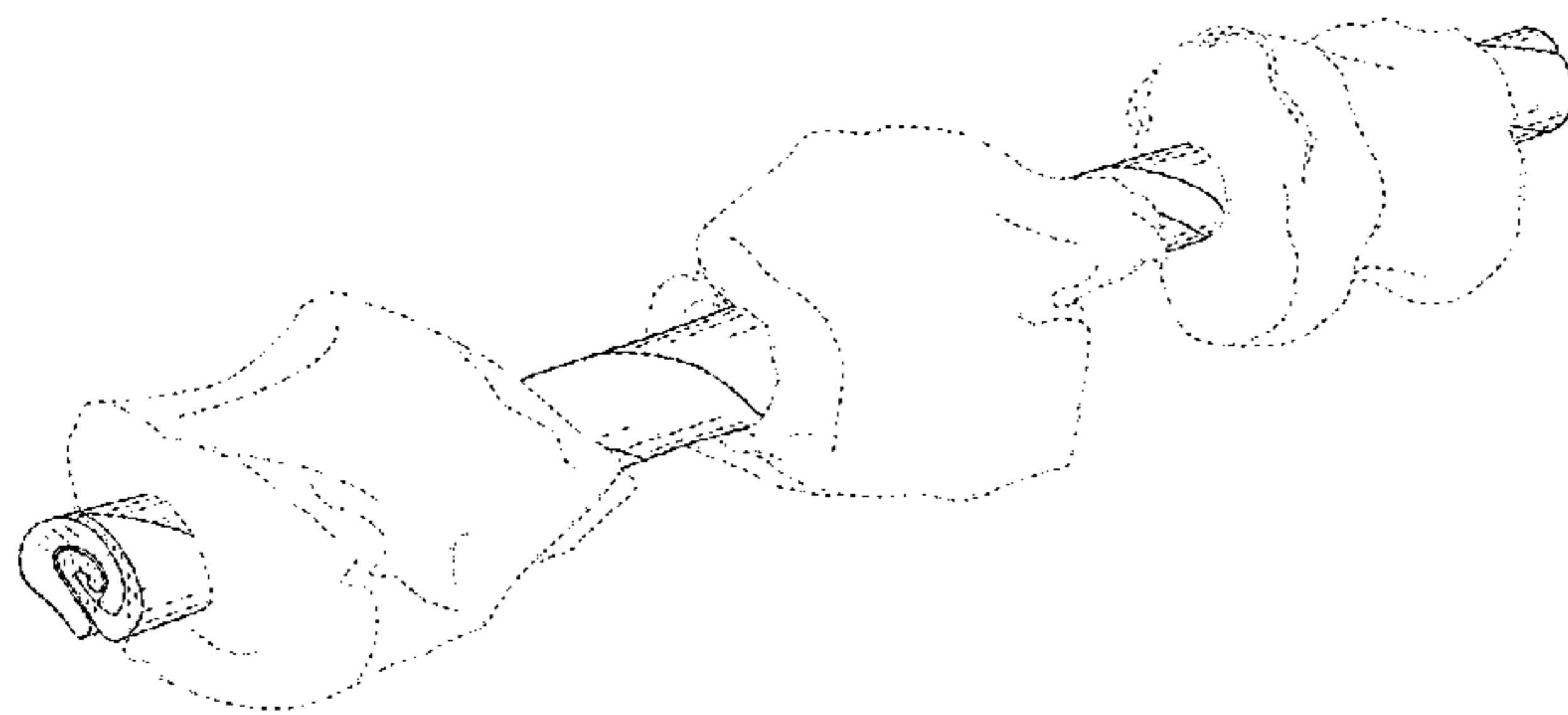

Related U.S. Application Data

division of application No. 29/549,670, filed on Dec. 28, 2015, now Pat. No. Des. 781,525.

(58) **Field of Classification Search**

USPC 426/138-139, 143, 144, 279, 282, 283, 426/391, 514, 549, 559, 560, 660, 808; D9/439, 669; D24/130; D6/597, 598, D6/601; D21/488-490, 493, 680; D23/366, 386, 415; 239/44; D8/83; D30/160

CPC . A23G 3/50; A23G 3/54; A23G 9/282; A23G 3/28; A23J 3/26; A23L 1/0067

See application file for complete search history.

(56) **References Cited**

U.S. PATENT DOCUMENTS

1,778,485	A	10/1930	Davidson	
2,036,706	A	4/1936	Ward	
2,116,310	A	8/1936	Holman	
2,185,547	A	1/1940	Fowler	
D133,869	S	7/1942	Donahue	
2,469,589	A	5/1949	Barricini	
D174,999	S	6/1955	Schall	
2,988,045	A	6/1961	Fisher	
3,331,549	A *	7/1967	Beasley	B65D 3/00 229/202
3,858,495	A	1/1975	Gotwalt	
3,939,761	A	2/1976	McGinty	
4,902,519	A	2/1990	Ream et al.	
4,924,811	A	5/1990	Axelrod	
5,166,798	A	11/1992	Cho	
5,168,798	A	12/1992	Kristofich et al.	
5,193,443	A	3/1993	Carney	
5,296,209	A	3/1994	Simone et al.	
5,586,963	A *	12/1996	Lennon	B31C 3/04 156/195
D391,735	S	3/1998	Baker	
D392,435	S	3/1998	Mocking et al.	
5,819,453	A *	10/1998	Eichert	G09F 15/0062 40/411
D408,948	S	4/1999	Huettner et al.	
D415,803	S	10/1999	Cousins	
6,042,873	A	3/2000	Lawson	
6,054,159	A	4/2000	Manzone	
D427,391	S	6/2000	Gill	
6,113,956	A	9/2000	Bower	
6,159,508	A	12/2000	Wolf et al.	
6,228,402	B1	5/2001	Wolf et al.	
6,277,420	B1	8/2001	Anderson et al.	
D476,118	S *	6/2003	Kirch	D30/160
6,601,539	B1	8/2003	Snook	
D485,046	S	1/2004	Hague	
D497,457	S	10/2004	Willinger	
6,827,041	B2	12/2004	Hague et al.	
D503,507	S	4/2005	Jia et al.	
D505,533	S	5/2005	Jia et al.	
D508,762	S	8/2005	Jia et al.	
D522,711	S	6/2006	Nakata	
D522,713	S *	6/2006	Nakata	D1/125
D525,397	S	7/2006	Wang	
D569,077	S	5/2008	Axelrod	
7,485,330	B2	2/2009	Anderson et al.	
D594,182	S	6/2009	Hague	
D626,706	S	11/2010	Ragonetti	
D627,537	S *	11/2010	Passi	D1/126
D645,640	S	9/2011	Mingyun et al.	
D649,736	S	12/2011	Cheung	
D650,146	S	12/2011	Cheung	
D651,771	S	1/2012	Shanghai	
D657,235	S *	4/2012	Wang	D8/499
D660,546	S *	5/2012	Joseph	D1/128
D661,458	S	6/2012	Mingyun et al.	
D672,099	S	12/2012	Simms et al.	

8,491,950	B2	7/2013	Grammer et al.	
D696,836	S	1/2014	Chen	
D706,091	S	6/2014	DiCosimo	
D708,417	S	7/2014	Allen	
D708,418	S	7/2014	Allen	
D708,818	S	7/2014	Axelrod et al.	
D721,210	S	1/2015	Diskin	
D726,991	S	4/2015	Albuja	
9,010,821	B2	4/2015	Stern	
9,044,039	B2	6/2015	Xu	
D741,555	S	10/2015	Byrne	
D743,639	S	11/2015	Byrne	
D744,175	S	11/2015	Byrne	
D752,841	S	4/2016	Neely et al.	
D759,341	S	6/2016	Templeman et al.	
D761,496	S	7/2016	Byrne	
D762,042	S	7/2016	Osenga	
D778,001	S	1/2017	Byrne	
D840,609	S *	2/2019	Axelrod	D30/160
2003/0106500	A1	6/2003	Kirch	
2003/0215547	A1	11/2003	Leyh, Jr.	
2004/0005392	A1	1/2004	Filipi et al.	
2004/0028783	A1	2/2004	Fullwood et al.	
2004/0126462	A1	7/2004	Tepper et al.	
2004/0219260	A1	11/2004	Anderson et al.	
2005/0069609	A1	3/2005	Straus et al.	
2005/0147719	A1	7/2005	Hill et al.	
2007/0193531	A1	8/2007	Anderson et al.	
2007/0218171	A1	9/2007	Mehrle et al.	
2007/0264415	A1	11/2007	Axelrod et al.	
2008/0014311	A1	1/2008	Tepper et al.	
2008/0145485	A1	6/2008	Tepper et al.	
2008/0175962	A1	7/2008	Grammer et al.	
2008/0193607	A1	8/2008	Tepper et al.	
2009/0029029	A1 *	1/2009	Lin	A23G 3/2053 426/660
2009/0162492	A1 *	6/2009	Conway, Jr.	A47G 21/18 426/85
2009/0235872	A1	9/2009	Filipi et al.	
2010/0062111	A1	3/2010	Langford	
2010/0303970	A1	12/2010	Grammer et al.	
2010/0304002	A1	12/2010	Grammer et al.	
2012/0234259	A1	9/2012	Xu	
2013/0266696	A1	10/2013	Shrestha et al.	
2013/0266712	A1	10/2013	Shrestha et al.	
2013/0295235	A1	11/2013	Albuja et al.	
2013/0309359	A1	11/2013	Langford	
2014/0186276	A1	7/2014	Mahe	
2014/0335223	A1	11/2014	Grammer et al.	
2015/0090192	A1	4/2015	Powers et al.	
2015/0181839	A1	7/2015	Baikie	
2016/0143320	A1	5/2016	Mahe et al.	

FOREIGN PATENT DOCUMENTS

DE	10 2015 107 453	8/2016
WO	2004062522	7/2004
WO	2008003140	1/2008
WO	2017/117143 A1	7/2017

OTHER PUBLICATIONS

Good N' Fun Kabob, Retrieved from Internet URL: <<https://www.target.com/p/good-n-39-fun-kabob-12oz/>>, 8 pages (Year: 2020).
 The Sizzling Pan, "Asparagus-Potato-Oats Kabobs," Apr. 24, 2014, Retrieved from Internet URL: <<http://my-kitchens-aroma.blogspot.com/2014/04/asparagus-potato-oats-kababs.html>>, 10 pages (Year: 2014).
 Elle, "Elle's Kitchen: Adana Kebab" American Homestead, (Jun. 16, 2012), Web Oct. 24, 2016, <<http://americanhomestead.blogspot.com/2012/06/elles-kitchen-adana-kebab.html>>.
 Hair, Jaden, "Asian Steak Kabobs" Steamy Kitchen, (Jul. 15, 2011), Web. Dec. 29, 2016, <<http://steamykitchen.com/16839-asian-steak-kabobs-recipe.html#comments>>.
 Dingo, Porkie Roll Pork and Porkhide Dog Chew Sticks, <http://www.dingobrand.com/Products/Rawhide-sticksfor-dogs/Porkie-porkhide-dog-chew-sticks.aspx>, printed Dec. 8, 2016.

(56)

References Cited

OTHER PUBLICATIONS

Dingo, Dynostix Rawhide Chew Sticks, <http://www.dingobrand.com/Products/Rawhide-sticks-for-dogs/Copy-of-Dynostix-rawhide-chew-sticks.aspx>, printed Dec. 8, 2016.

Dingo, Twist Sticks Chicken Rawhide Twists, <http://www.dingobrand.com/Products/Rawhide-sticks-for-dogs/Twist-Sticks-Chicken-50-Pack.aspx>, printed Dec. 8, 2016.

Dingo, Tartar Control Dental Sticks for Dogs, <http://www.dingobrand.com/Products/Dog-tartar-control-andremoval/How-to-remove-dog-tartar-dental-sticks.aspx>, printed Dec. 8, 2016.

International Search Report for International Application No. PCT/US2016/068741 dated Mar. 7, 2017 (14 pages).

Elfenbein. "Cooking for Dogs—Shish Kebabs." <http://twolittlecavaliers.com>, Jun. 10, 2012, 3 pages.

Unknown. "Griddled glazed vegetable kebabs." BBC Good Food, Jul. 2010, 3 pages retrieved from www.bbcgoodfood.com/recipes/588651/griddled-glazed-vegetable-kebabs.

International Search Report for International Application No. PCT/US2016/068728 dated Mar. 7, 2017 (14 pages).

Sacco, Brooke Dowd. "Web's Tastiest Halloween Food, Marshmallow & Pretzel Bones" Kid Crave. (Oct. 22, 2012), Web. May 24, 2017, <<http://kidcrave.com/scoop/webs-tastiest-halloween-food/>>.

Blonde Chicken, "Fluffy Cheesy Weiner Kebab," Instructable, (Aug. 11, 2012), Web. Jul. 27, 2018, <<https://www.instructables.com/id/Fluffy-Cheesy-Weiner-Kabobs/>>.

Extended European Search Report for Application No. 20185913.9 dated Aug. 13, 2020.

Lichty, Maria, "Sausage and Pepper Skewers," Two Peas and Their Pod Cookbook, 7 pages, Jun. 13, 2014, Web. Feb. 3, 2021, <<https://www.twopeasandtheirpod.com/sausage-and-pepper-skewers/>>.

* cited by examiner

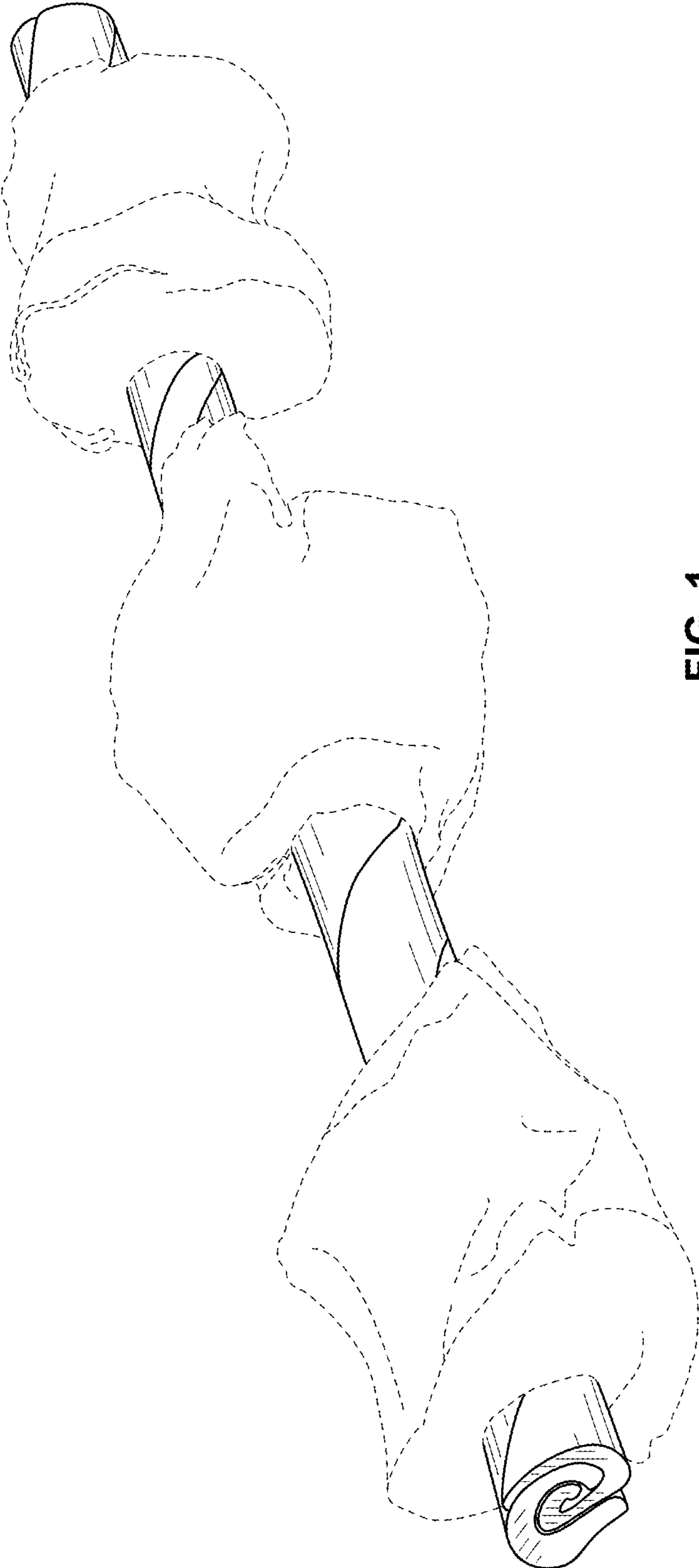

FIG. 1

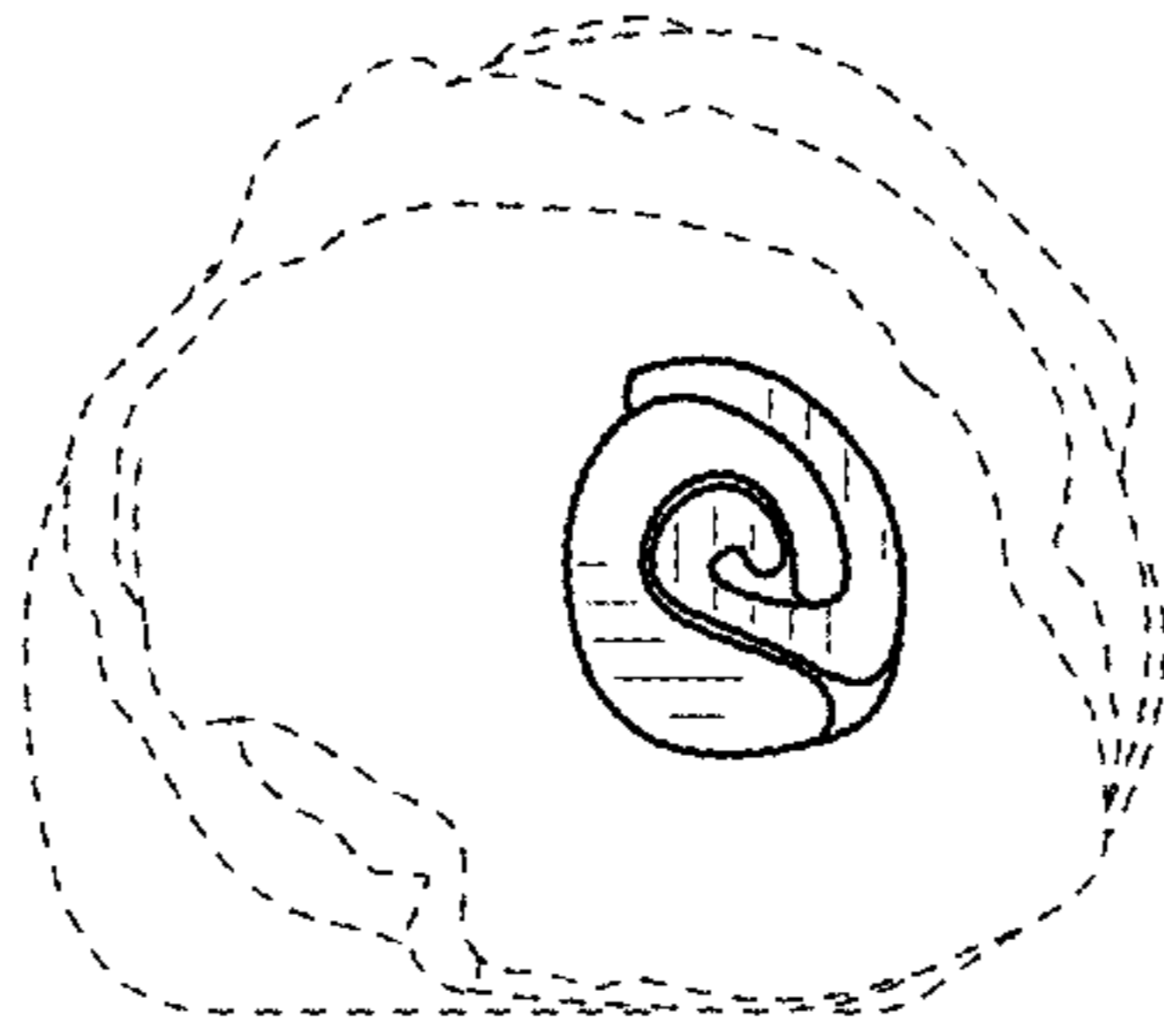

FIG. 2

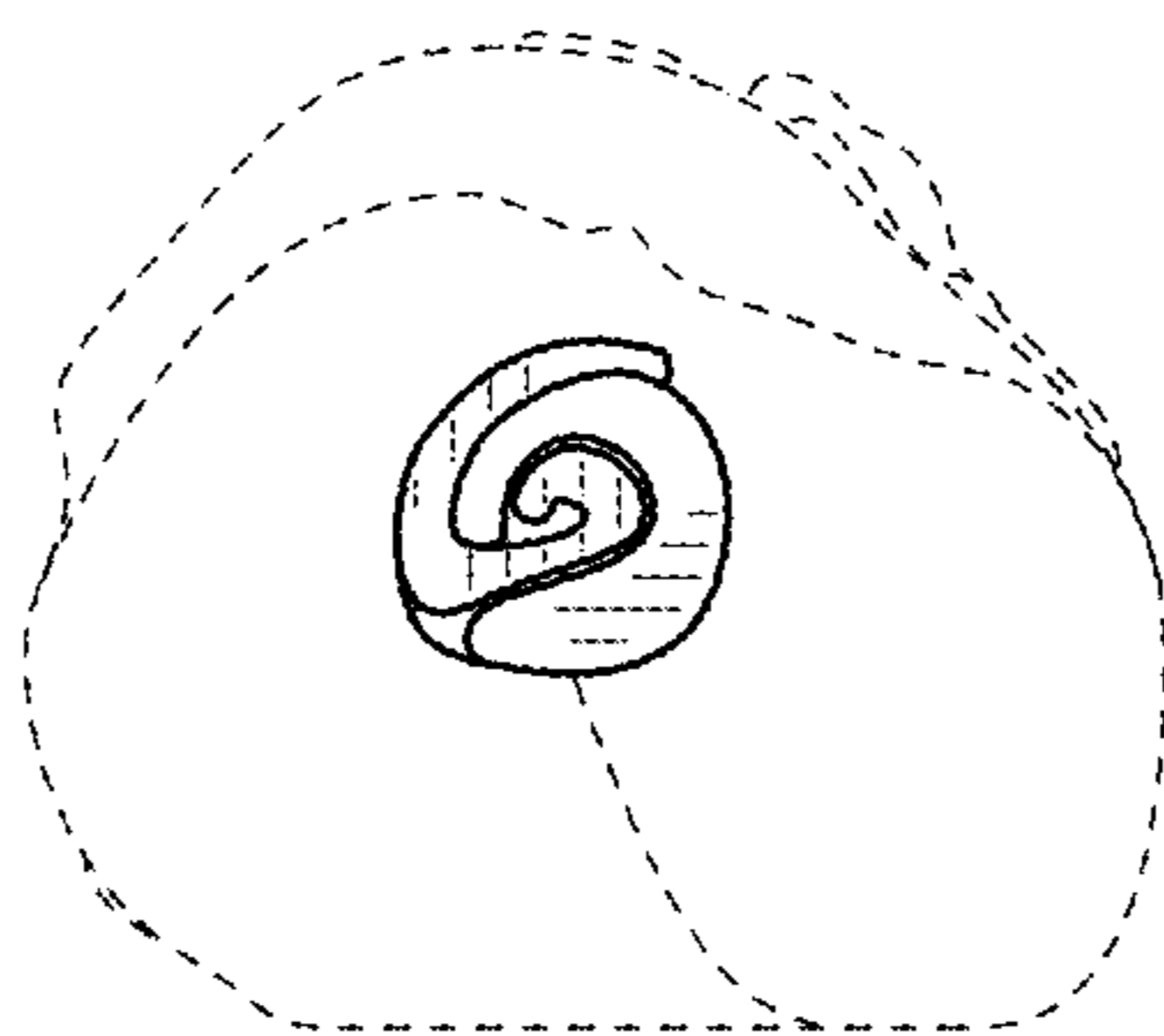

FIG. 3

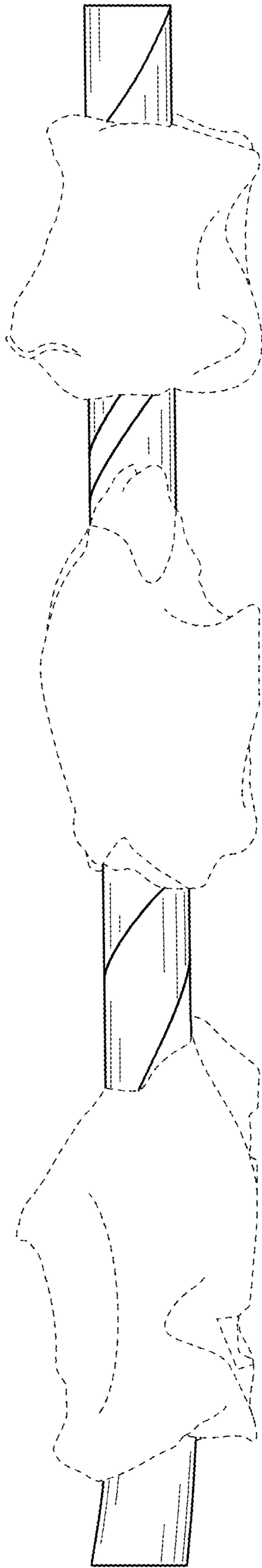

FIG. 4

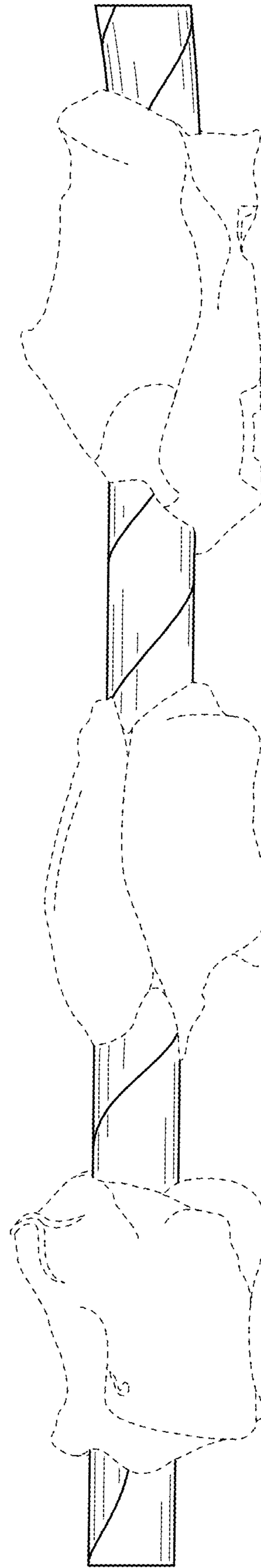

FIG. 5

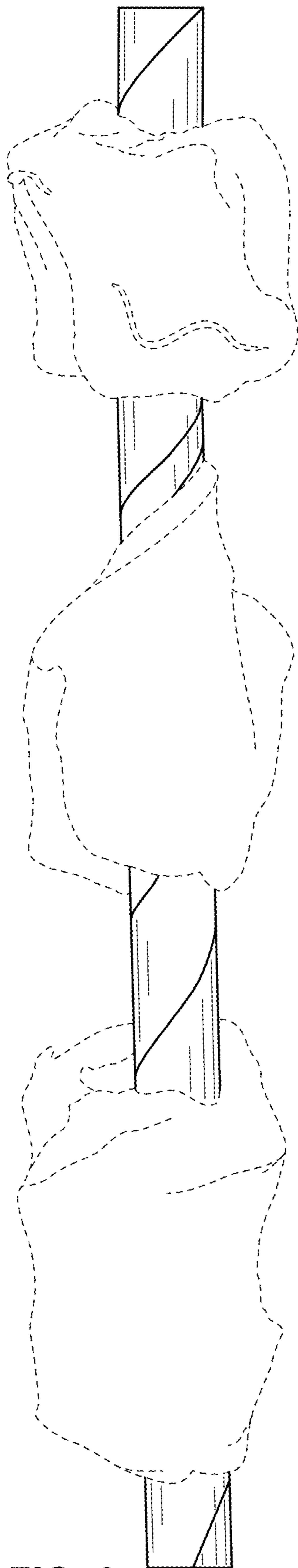

FIG. 6

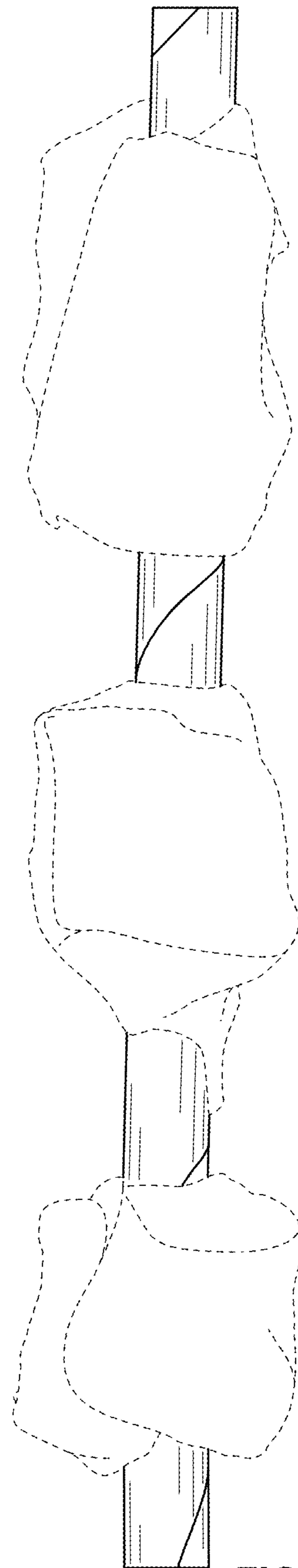

FIG. 7

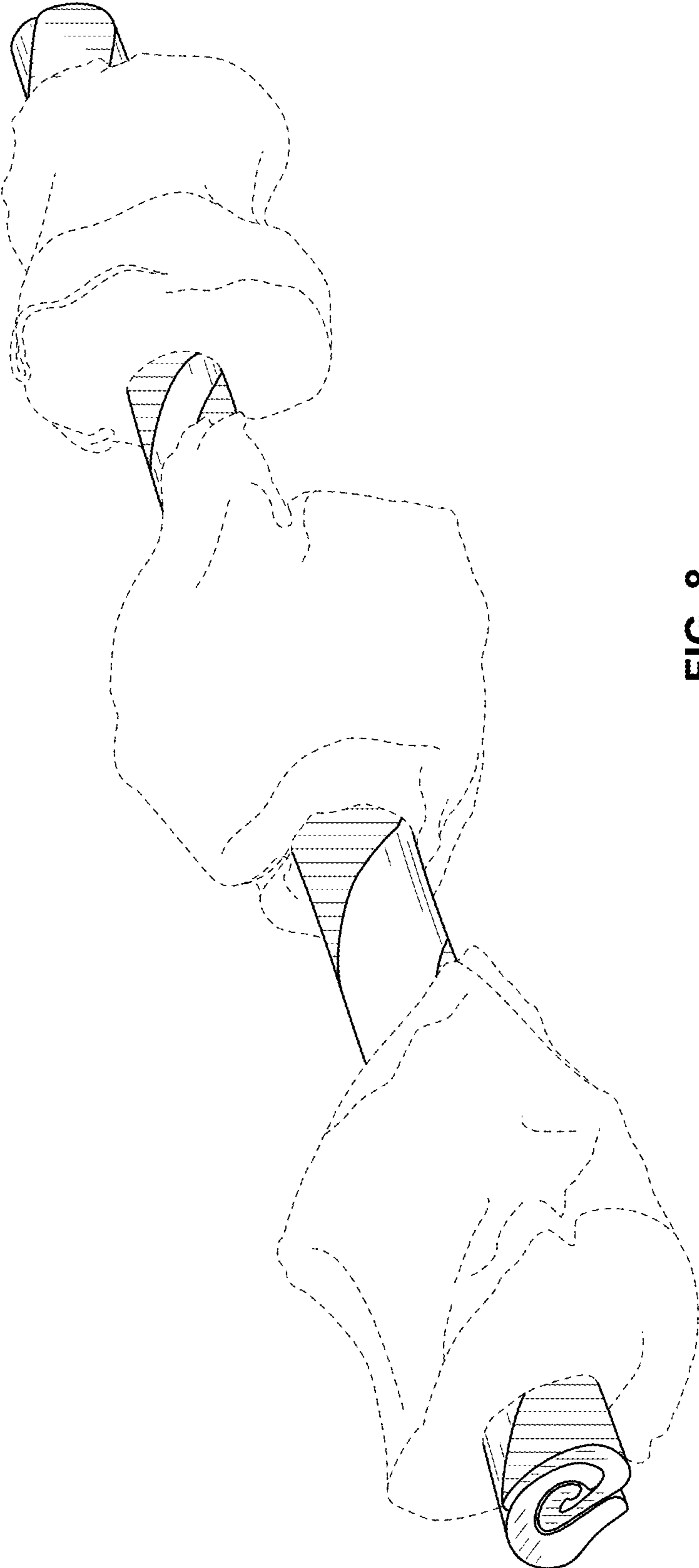

FIG. 8

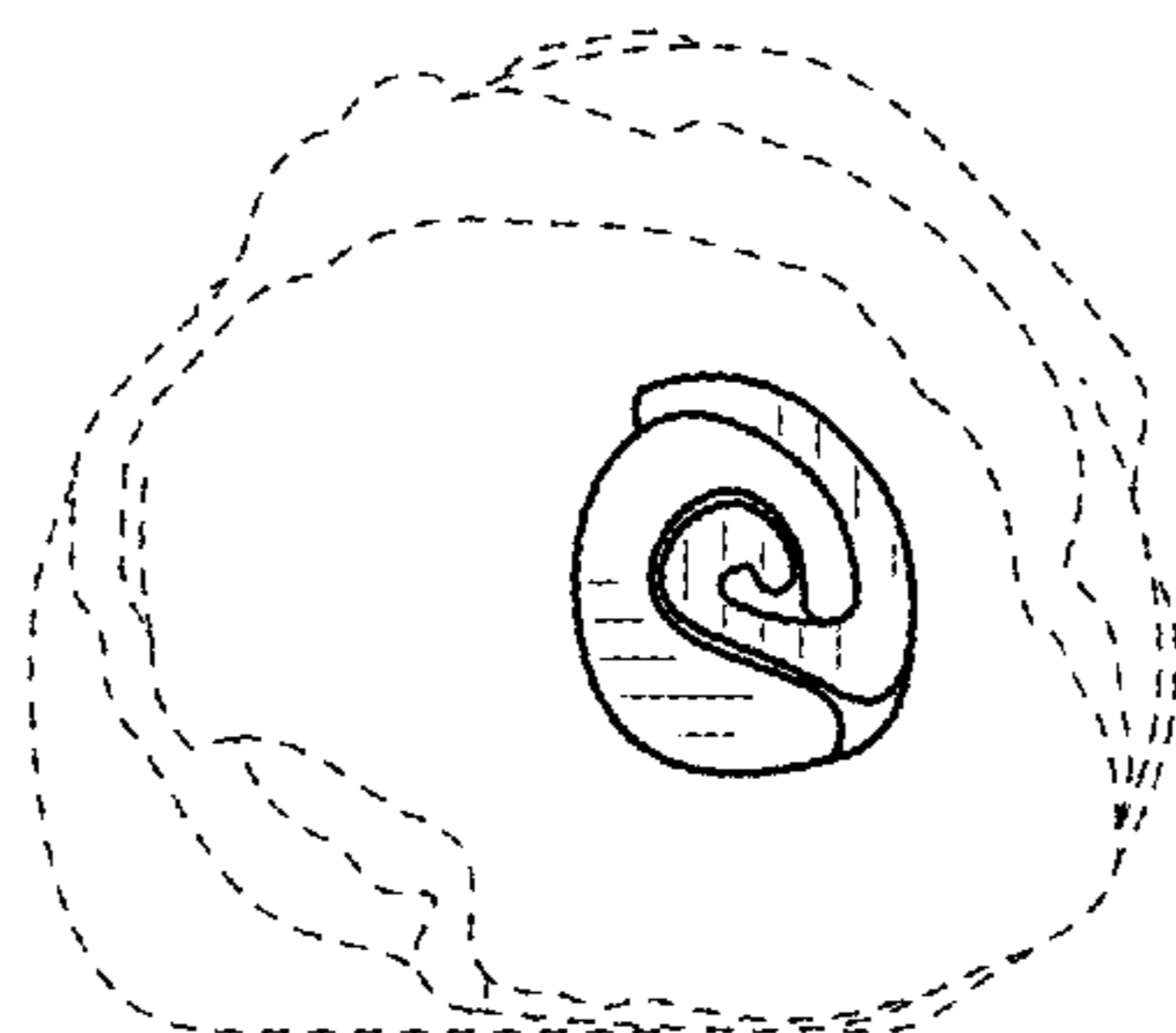

FIG. 9

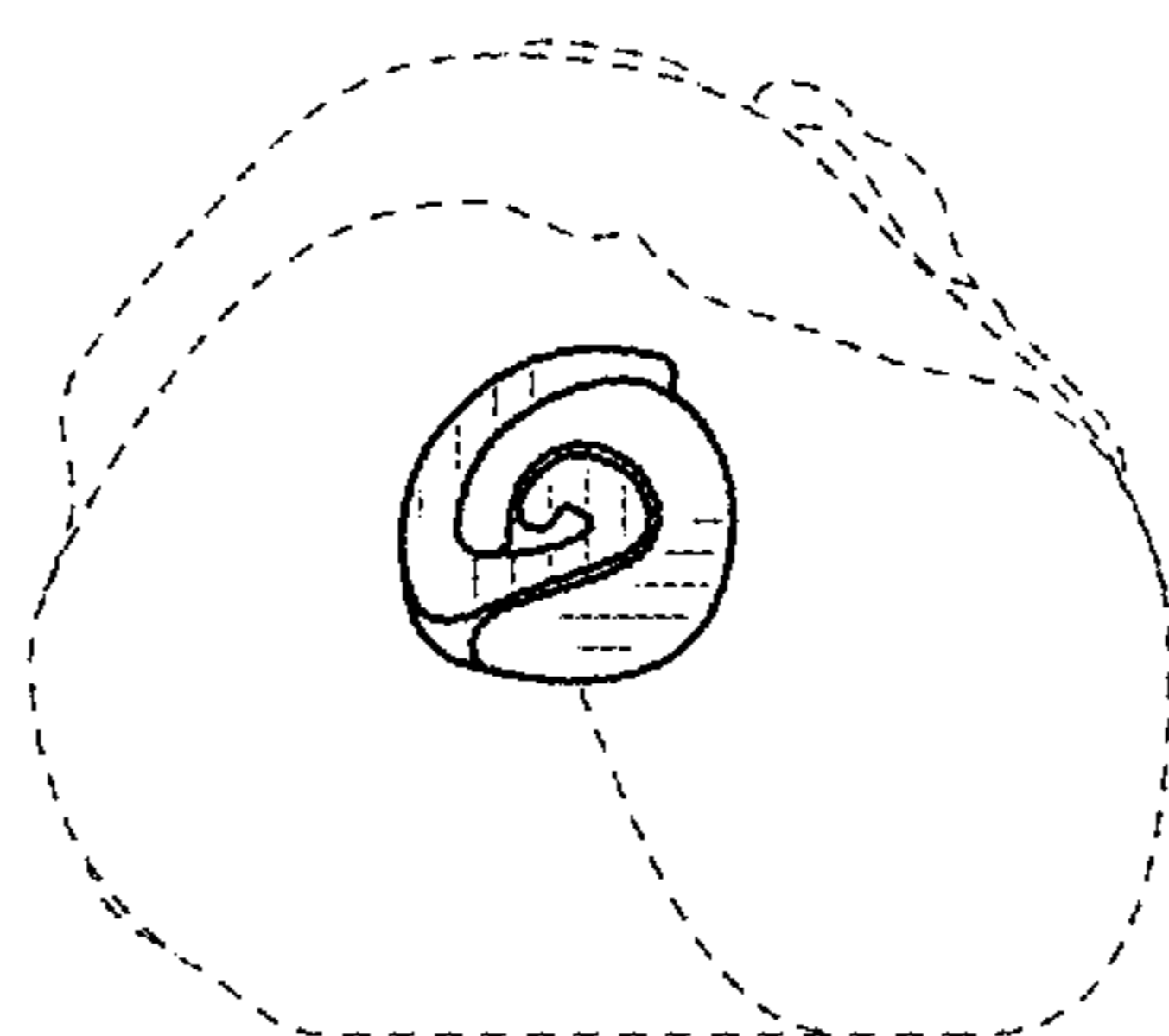

FIG. 10

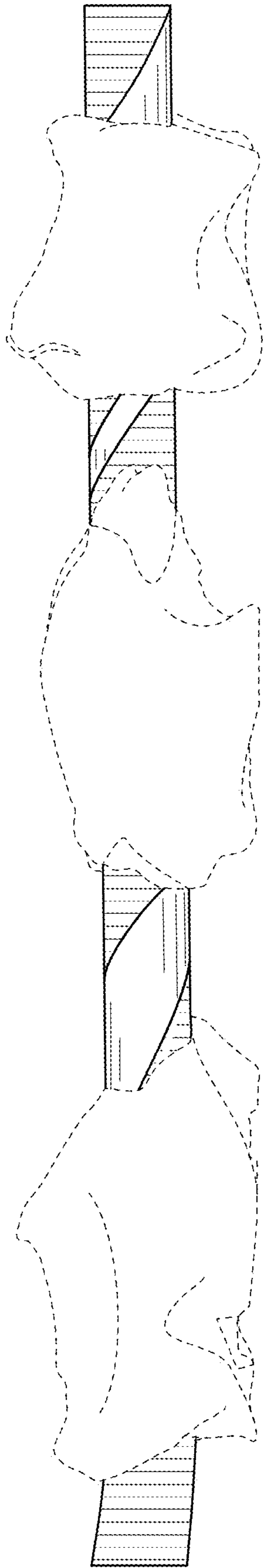

FIG. 11

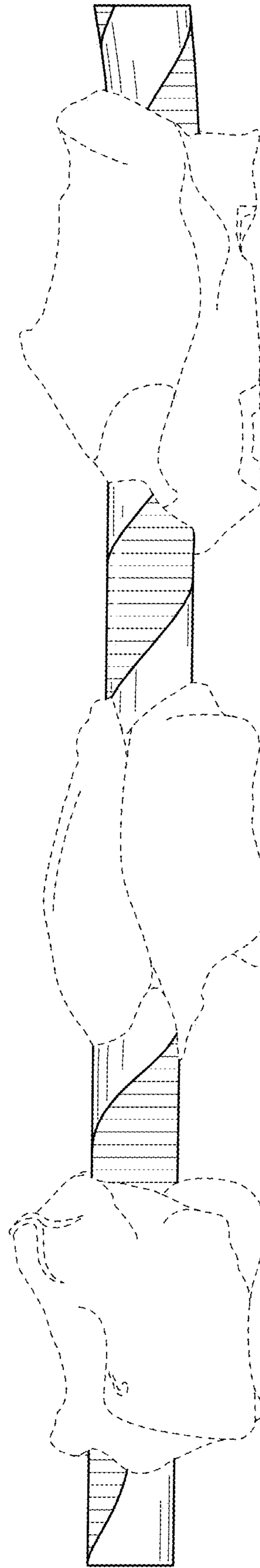

FIG. 12

