



US00D930253S

(12) **United States Design Patent**  
**Kerr**

(10) **Patent No.:** **US D930,253 S**

(45) **Date of Patent:** **\*\* Sep. 7, 2021**

(54) **TOOL FOR REMOVING ADHESIVE FROM HAIR EXTENSION WEFT**

(71) Applicant: **Ceven with a C, LLC**, Houston, TX (US)

(72) Inventor: **Cecilia Kerr**, Houston, TX (US)

(\*\*) Term: **15 Years**

(21) Appl. No.: **29/686,506**

(22) Filed: **Apr. 4, 2019**

(51) **LOC (13) Cl.** ..... **28-04**

(52) **U.S. Cl.**  
USPC ..... **D28/93**

(58) **Field of Classification Search**  
USPC ..... D28/92, 93, 99  
CPC ... A45D 8/24; A45D 8/26; A45D 8/30; A45D 8/34; A41G 3/0025; A42G 5/0033  
See application file for complete search history.

(56) **References Cited**

U.S. PATENT DOCUMENTS

5,638,836 A *	6/1997	Yasuda	.....	A45D 8/30 132/145
D393,927 S *	4/1998	Chou	.....	D28/42
D401,765 S *	12/1998	Soutullo	.....	D4/199
6,446,638 B1 *	9/2002	Horman	.....	A45D 8/24 132/275

D560,366 S \* 1/2008 Phillips ..... D4/199

\* cited by examiner

*Primary Examiner* — Zenia I Bennett

(74) *Attorney, Agent, or Firm* — Blank Rome LLP

(57) **CLAIM**

I claim the ornamental design for a tool for removing adhesive from hair extension weft.

**DESCRIPTION**

FIG. 1 is a perspective view of a tool for removing an adhesive from a hair extension weft, showing my new design;

FIG. 2 is a top plan view thereof;

FIG. 3 is a bottom plan view thereof;

FIG. 4 is a right side elevational view thereof, the left side being a mirror image;

FIG. 5 is a front elevational view thereof;

FIG. 6 is a rear elevational view thereof;

FIG. 7 is a perspective view of the tool in an open configuration;

FIG. 8 is a perspective view of the tool, with a roll of a fabric material incorporated therein; and,

FIG. 9 is a perspective view of the tool in an open configuration, with a roll of a fabric material incorporated therein.

The broken lines are for illustrating unclaimed portions of the tool. The broken lines form no part of the claimed design.

The appearance of any portion of the tool between break lines forms no part of the claimed design.

**1 Claim, 9 Drawing Sheets**

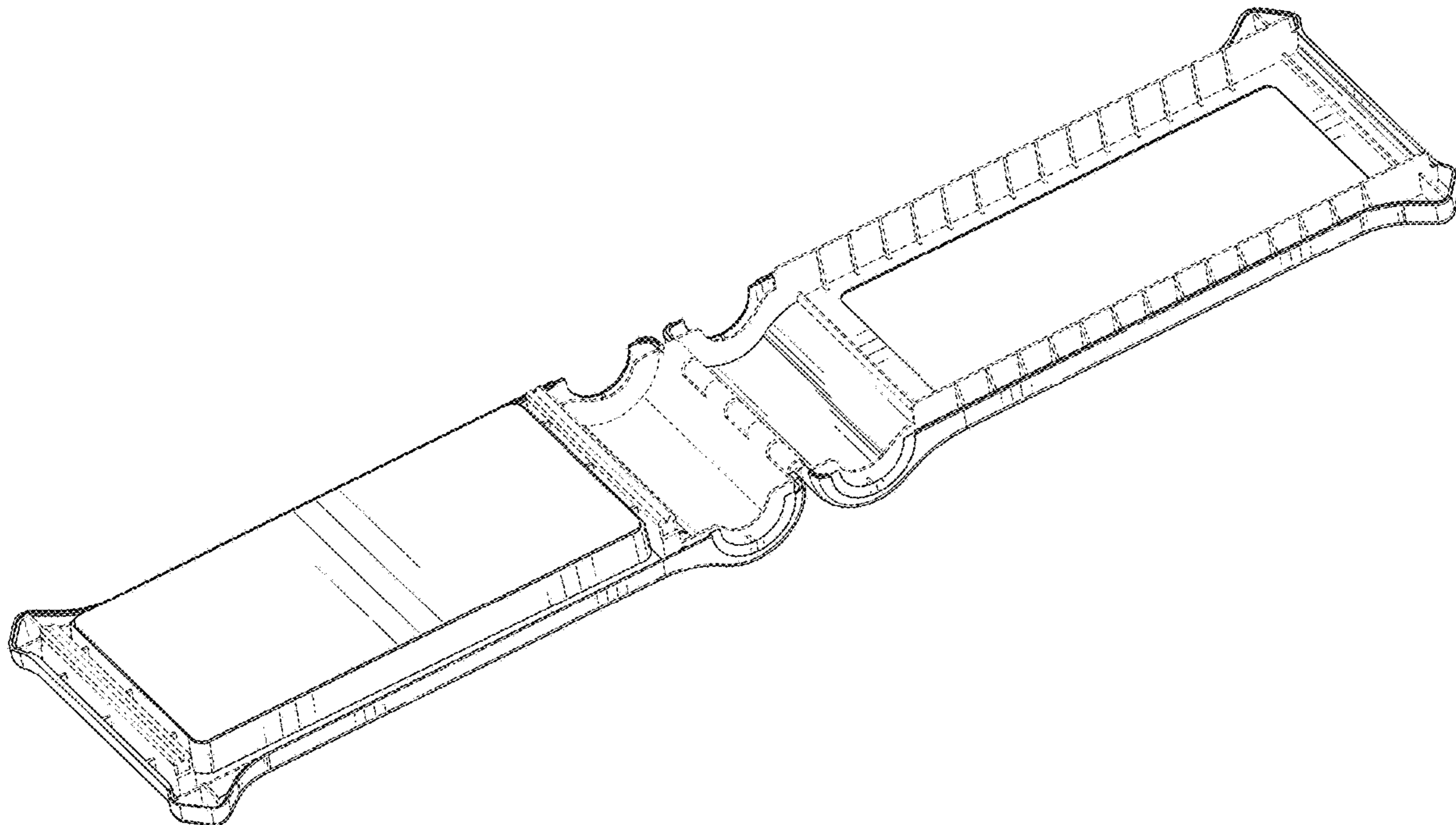

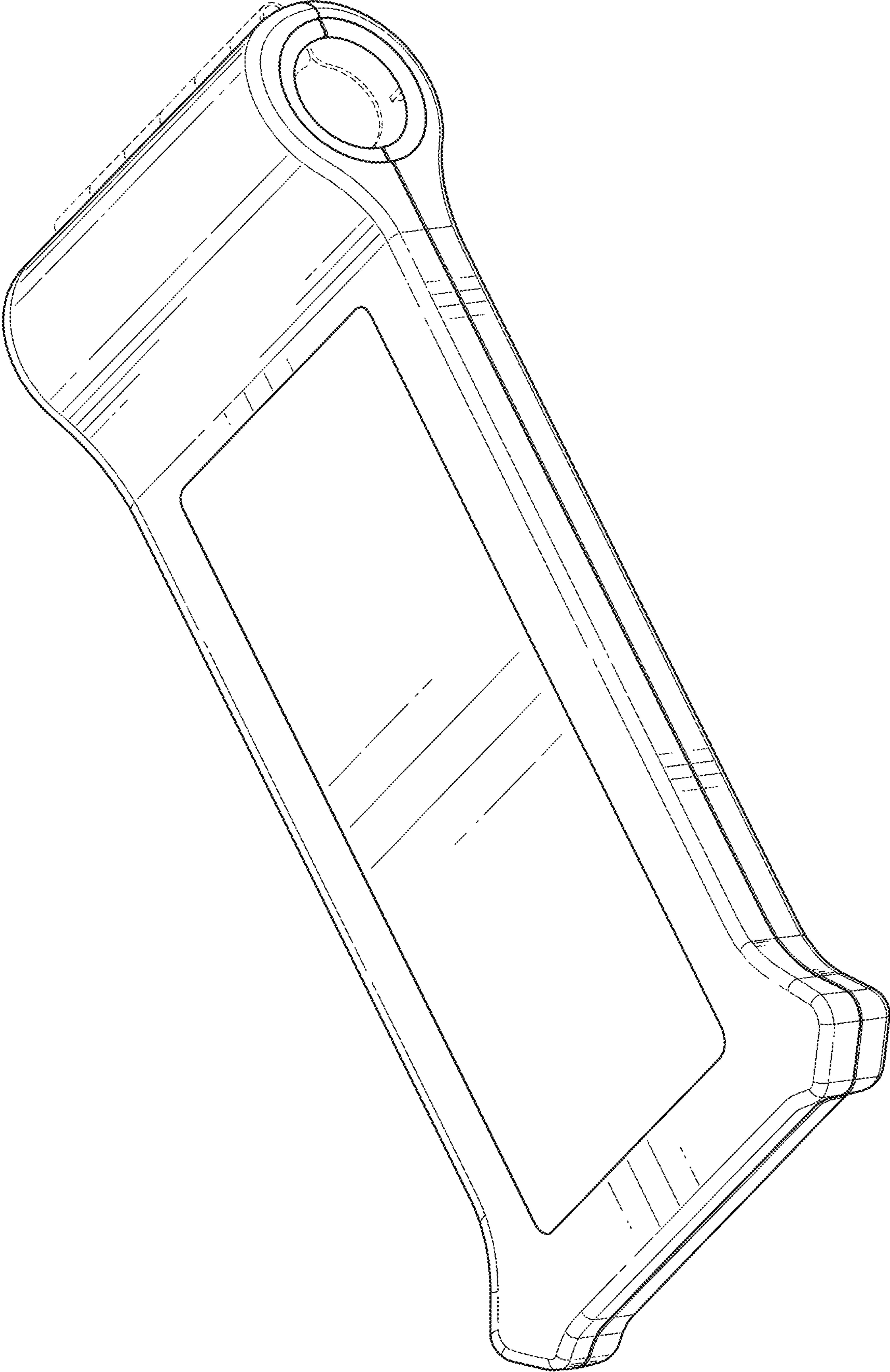

FIG. 1

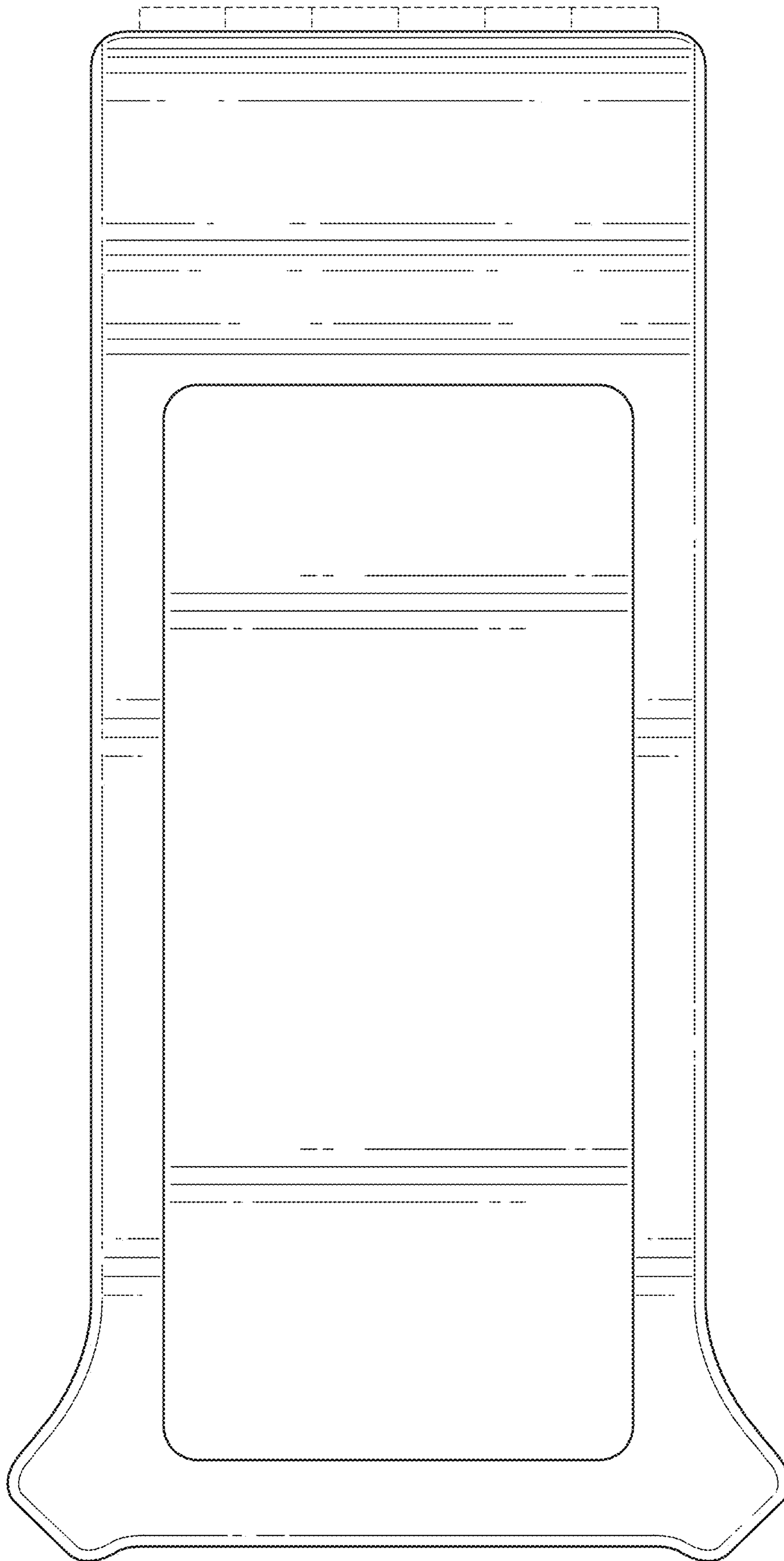

FIG. 2

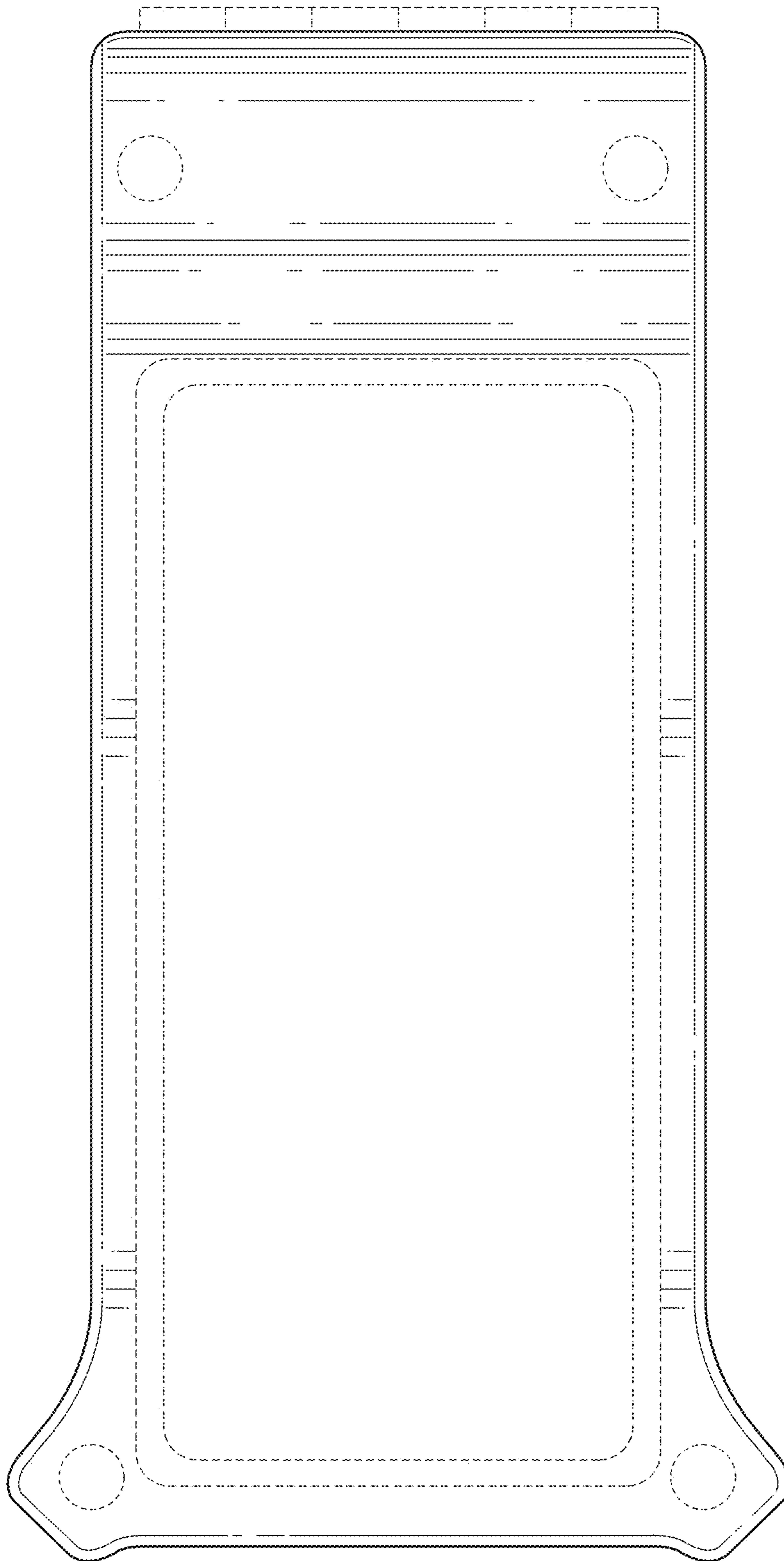

FIG. 3

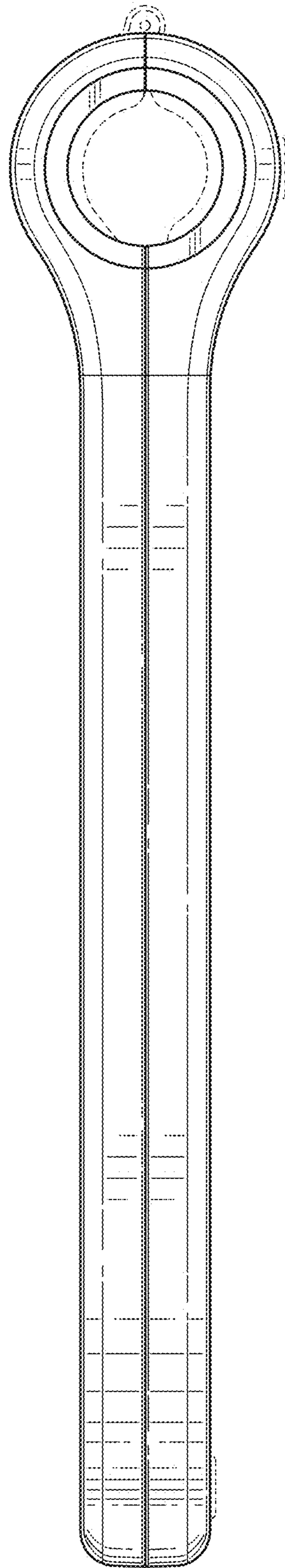

FIG. 4

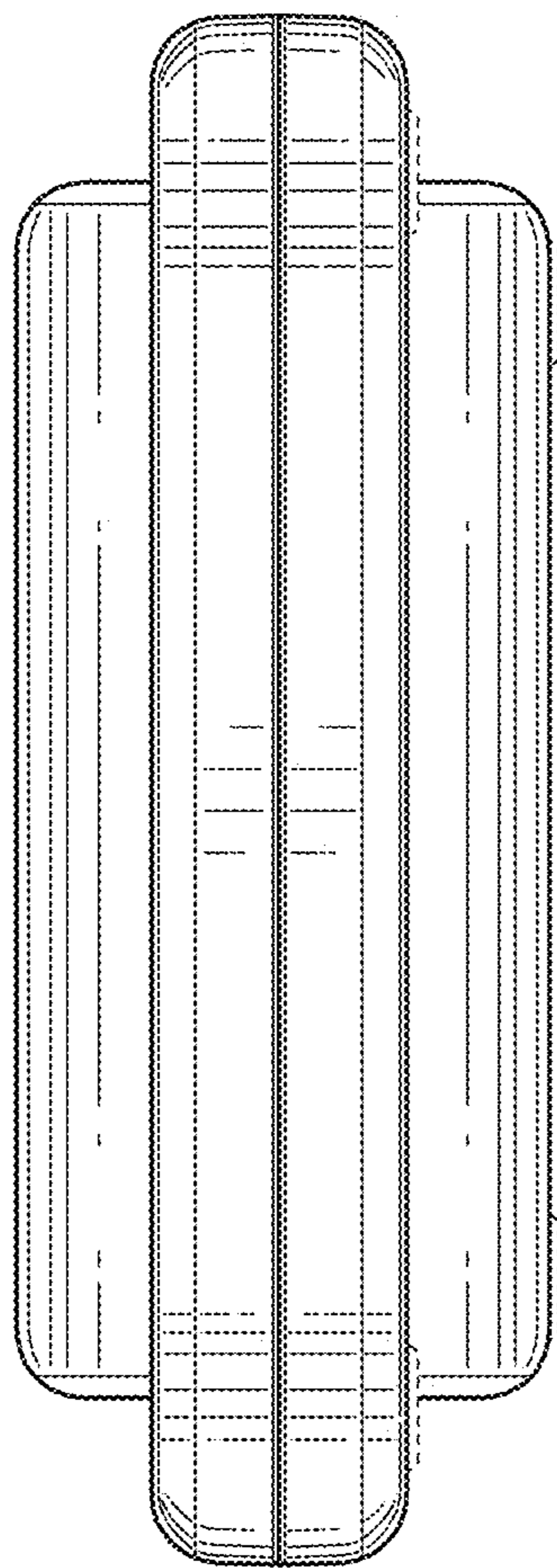

FIG. 5

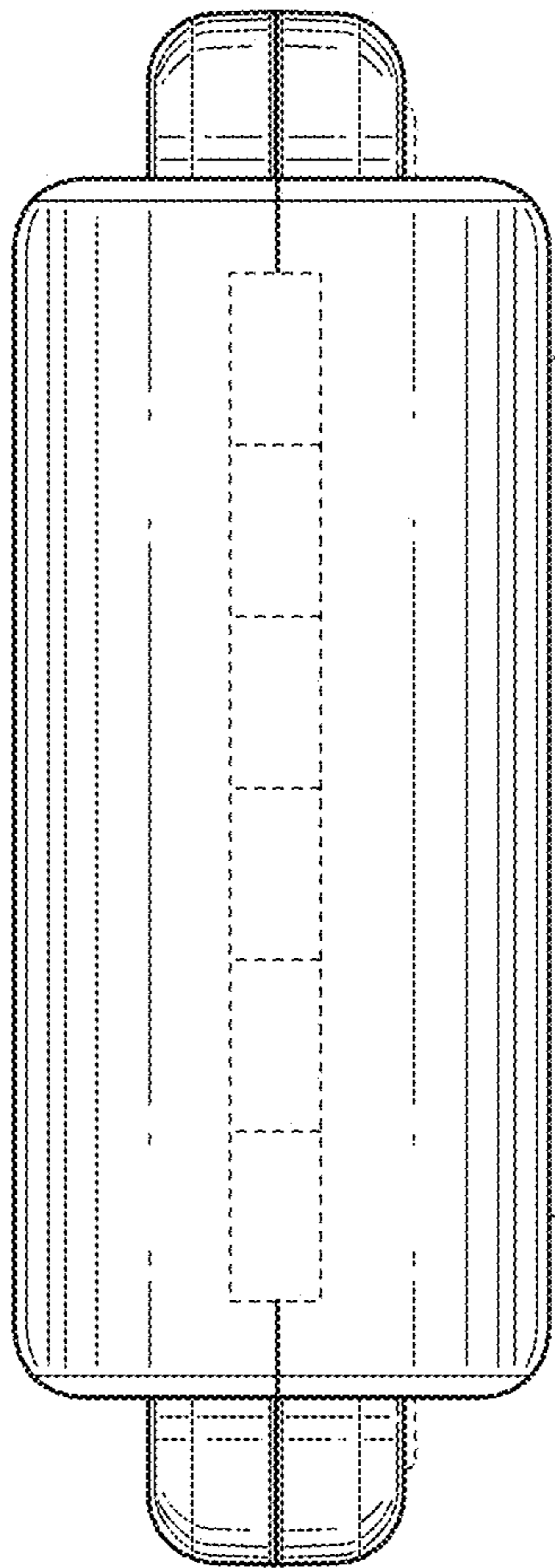

FIG. 6

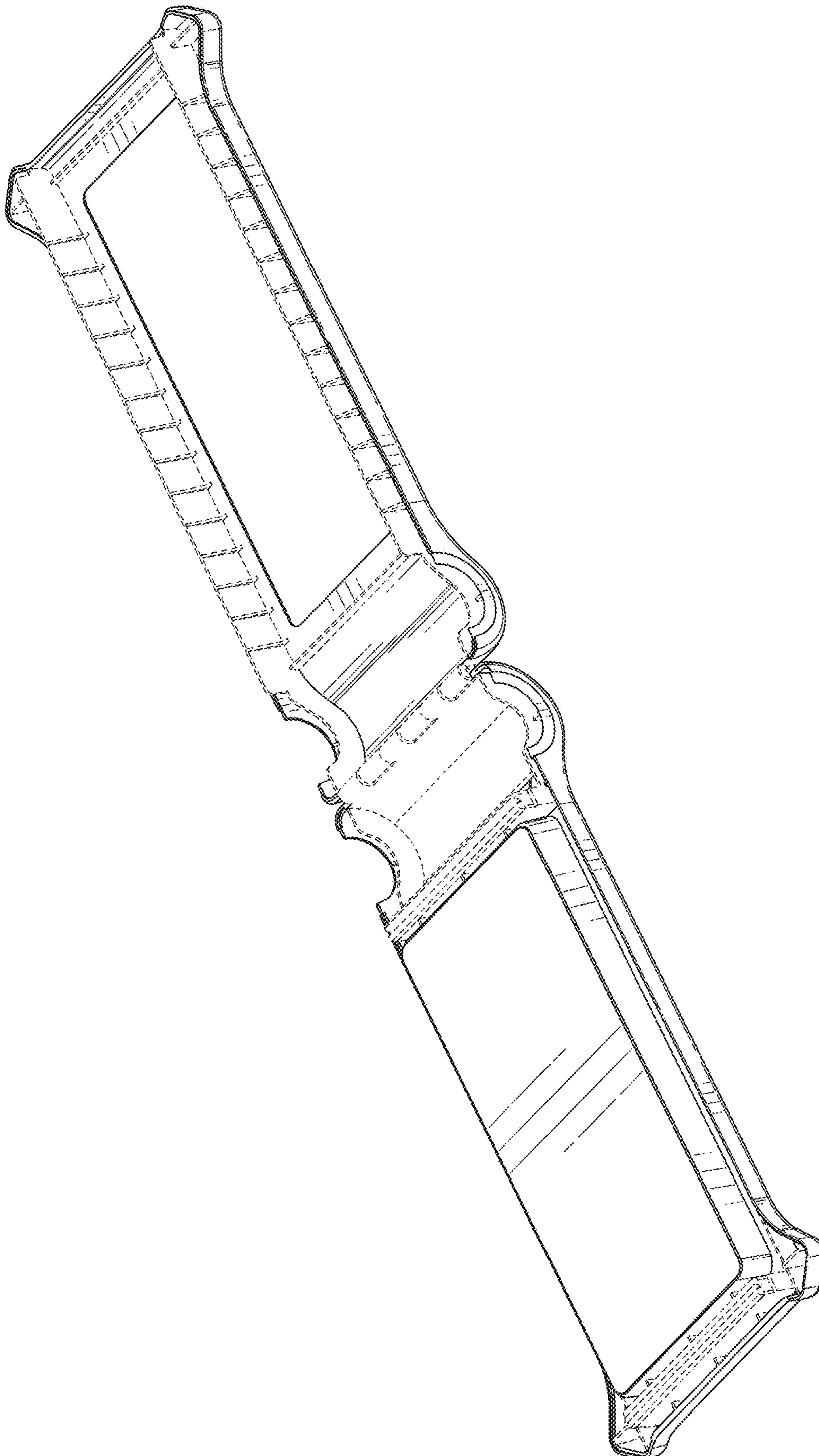

FIG. 7



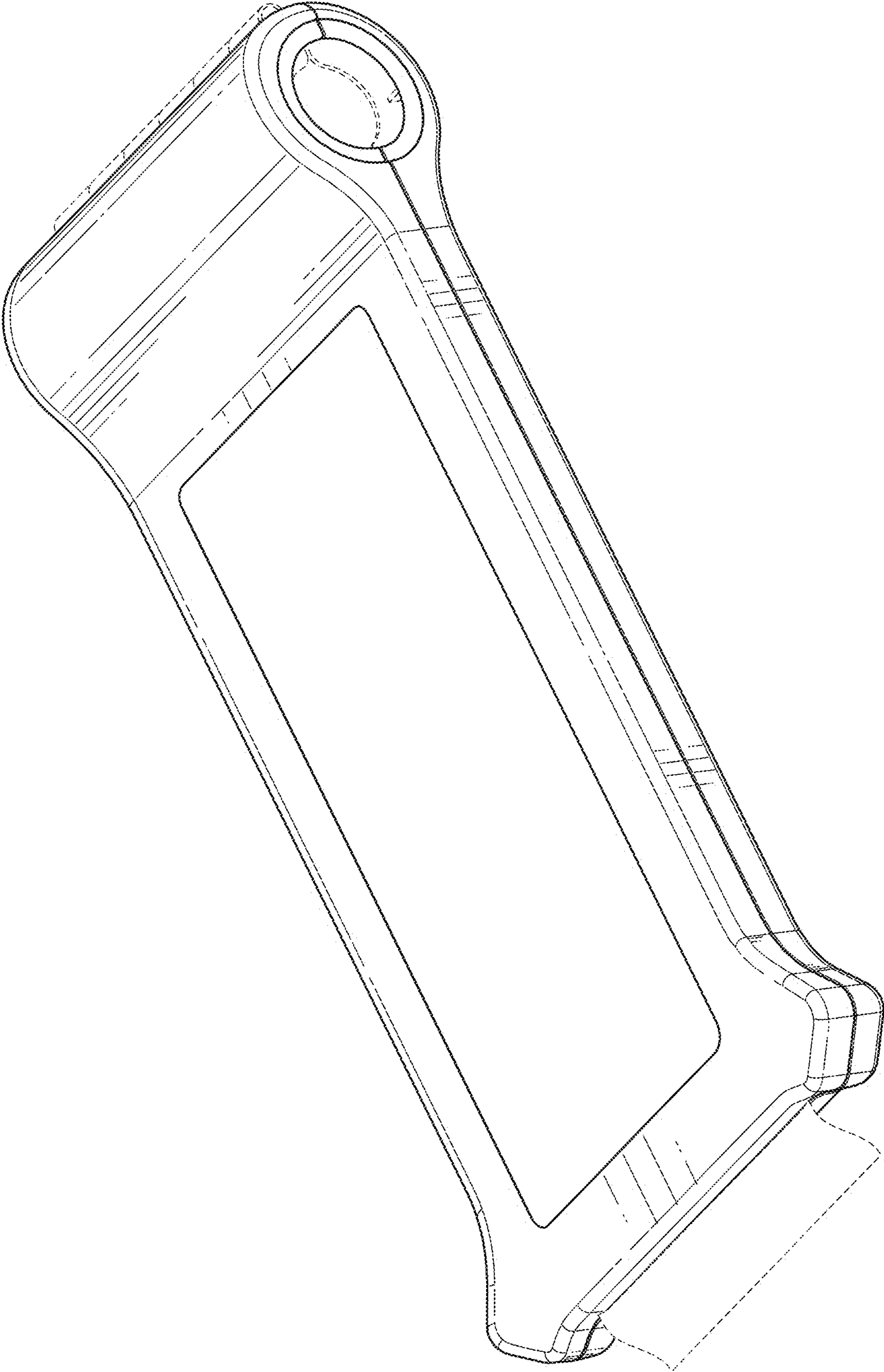

FIG. 8

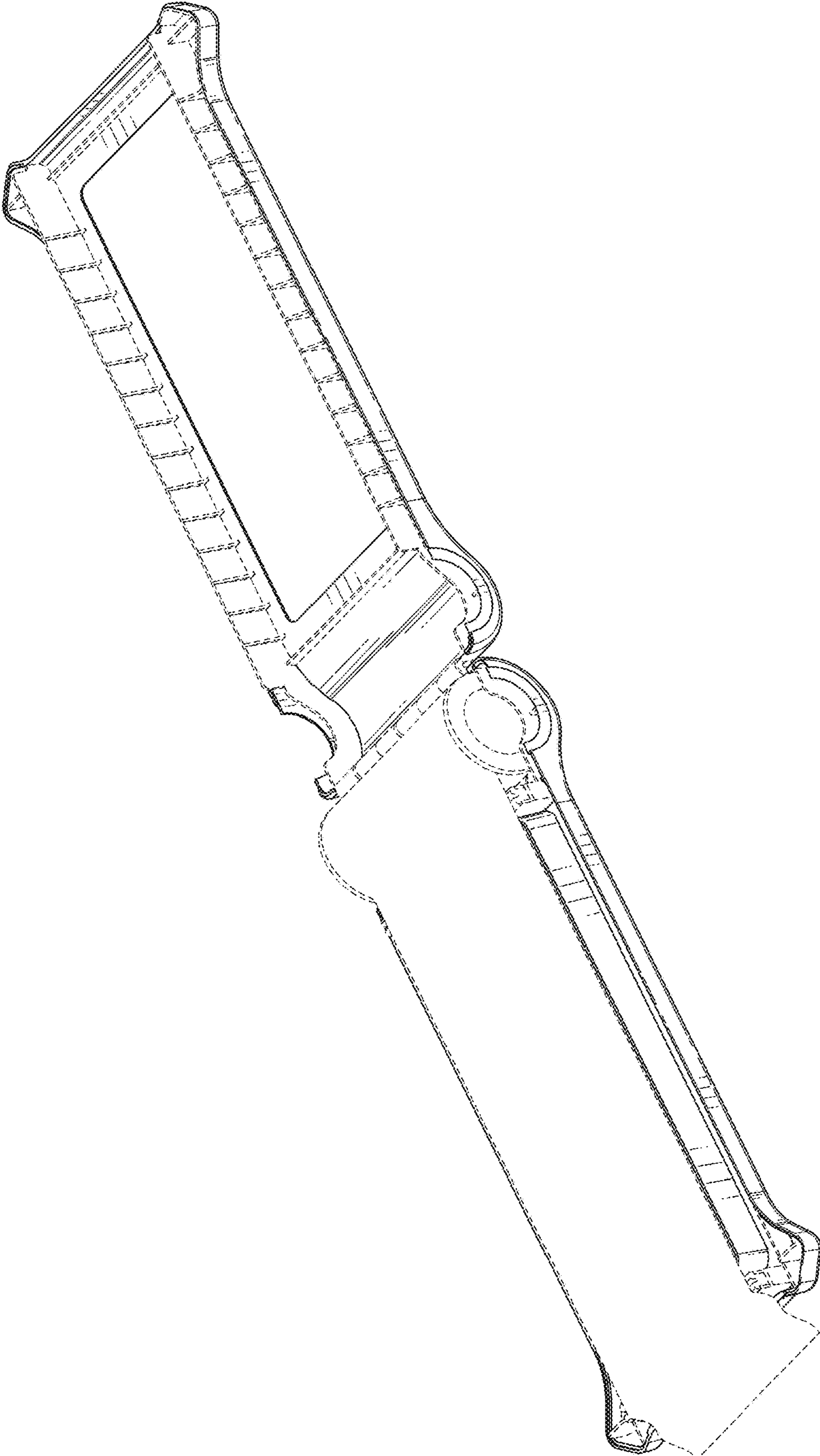

FIG. 9