



US00D930198S

(12) **United States Design Patent**
Wu

(10) **Patent No.:** **US D930,198 S**

(45) **Date of Patent:** **** Sep. 7, 2021**

(54) **VEHICLE LIGHT**

(71) Applicant: **COPLUS INC.**, Tainan (TW)

(72) Inventor: **Po-Hua Wu**, Tainan (TW)

(73) Assignee: **COPLUS INC.**, Tainan (TW)

(**) Term: **15 Years**

(21) Appl. No.: **29/729,104**

(22) Filed: **Mar. 24, 2020**

(30) **Foreign Application Priority Data**

Jan. 21, 2020 (TW) 109300325

(51) **LOC (13) Cl.** **26-06**

(52) **U.S. Cl.**
USPC **D26/28**

(58) **Field of Classification Search**
USPC D26/28, 29, 30, 31, 32, 33, 34, 35, 36,
D26/44

CPC F21S 48/00; F21S 48/10; F21S 48/115;
F21S 48/225; F21S 48/1233; F21S
48/1266; F21S 48/1388; F21S 48/2268;
F21V 21/04; F21W 2103/35; F21W 3/40;
F21W 2102/17; F21W 2102/30; F21W
2103/00; F21W 2103/55; F21W 2104/00;
F21W 2107/17; F21W 2107/13

See application file for complete search history.

(56) **References Cited**

U.S. PATENT DOCUMENTS

D570,007 S * 5/2008 Hsu D26/28
D637,324 S * 5/2011 Yang D26/28

D691,309 S * 10/2013 Lai D26/28
D706,470 S * 6/2014 Lai D26/28
D761,460 S * 7/2016 Lin D26/28
D768,320 S * 10/2016 Lai D26/28
D850,676 S * 6/2019 Lin D26/28
D874,038 S * 1/2020 He D26/28
D878,645 S * 3/2020 Lai D26/28
D883,534 S * 5/2020 He D26/28
D883,538 S * 5/2020 Lai D26/28
D905,876 S * 12/2020 Wu D26/28
D909,644 S * 2/2021 Chen D26/28

* cited by examiner

Primary Examiner — Angela J Lee

(74) *Attorney, Agent, or Firm* — Lewis Roca Rothgerber
Christie LLP

(57) **CLAIM**

The ornamental design for vehicle light, as shown and described.

DESCRIPTION

FIG. 1 is a perspective view of a vehicle light;
FIG. 2 is a front view thereof;
FIG. 3 is a back view thereof;
FIG. 4 is a left side view thereof;
FIG. 5 is a right side view thereof;
FIG. 6 is a top view thereof; and,
FIG. 7 is a bottom view thereof.

The broken lines in the drawings are for illustrative purpose only and form no part of the claimed design.

1 Claim, 7 Drawing Sheets

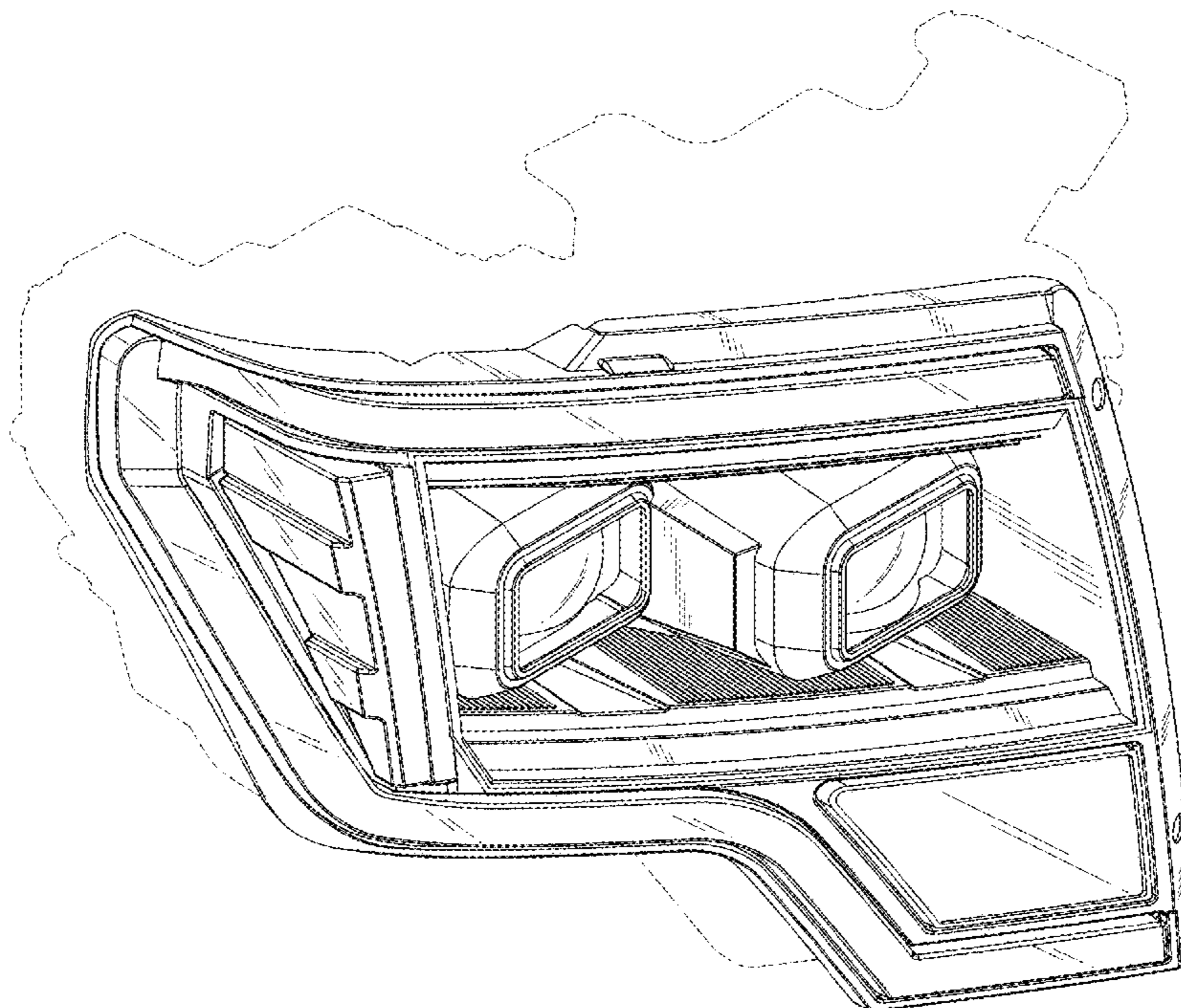

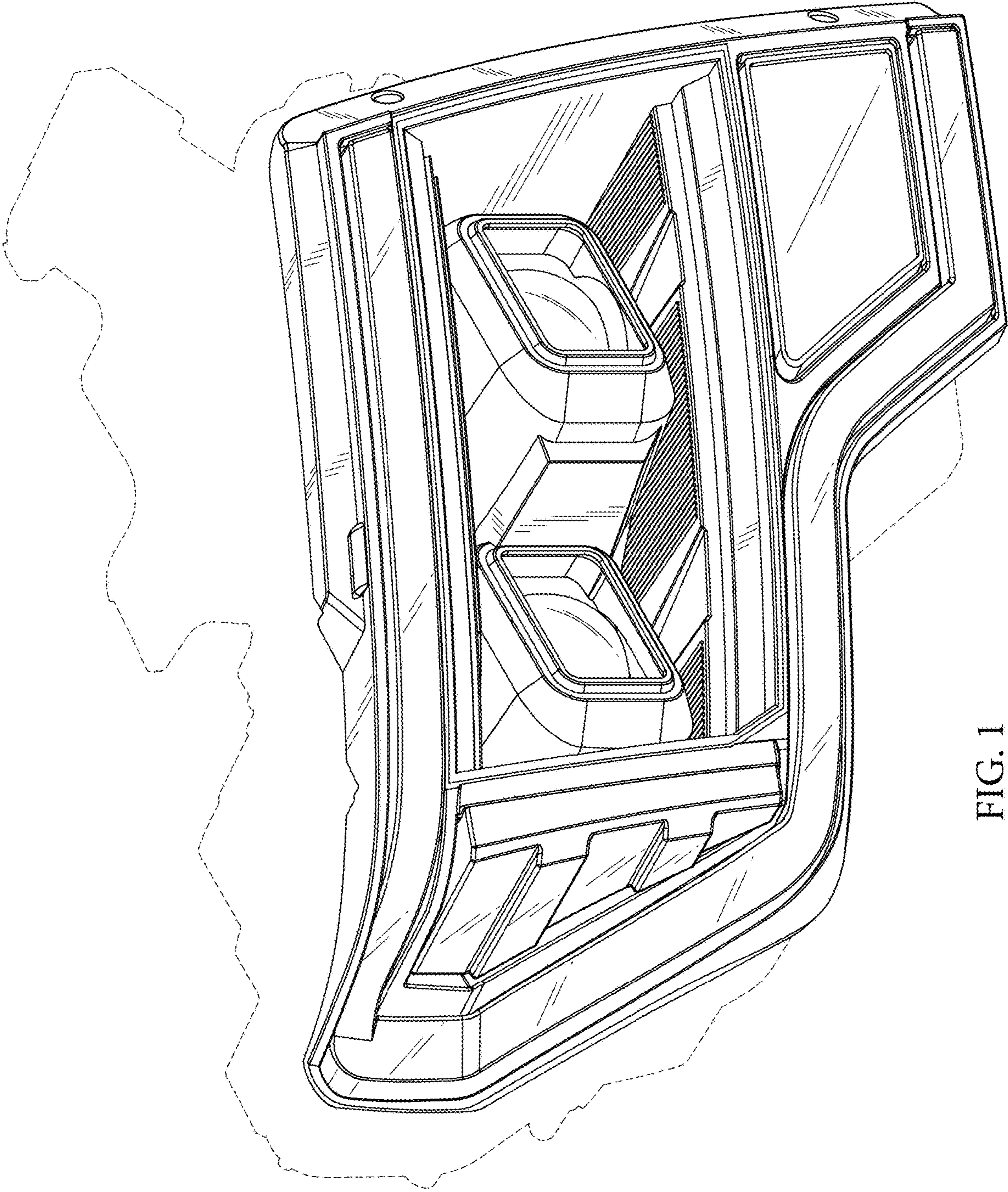

FIG. 1

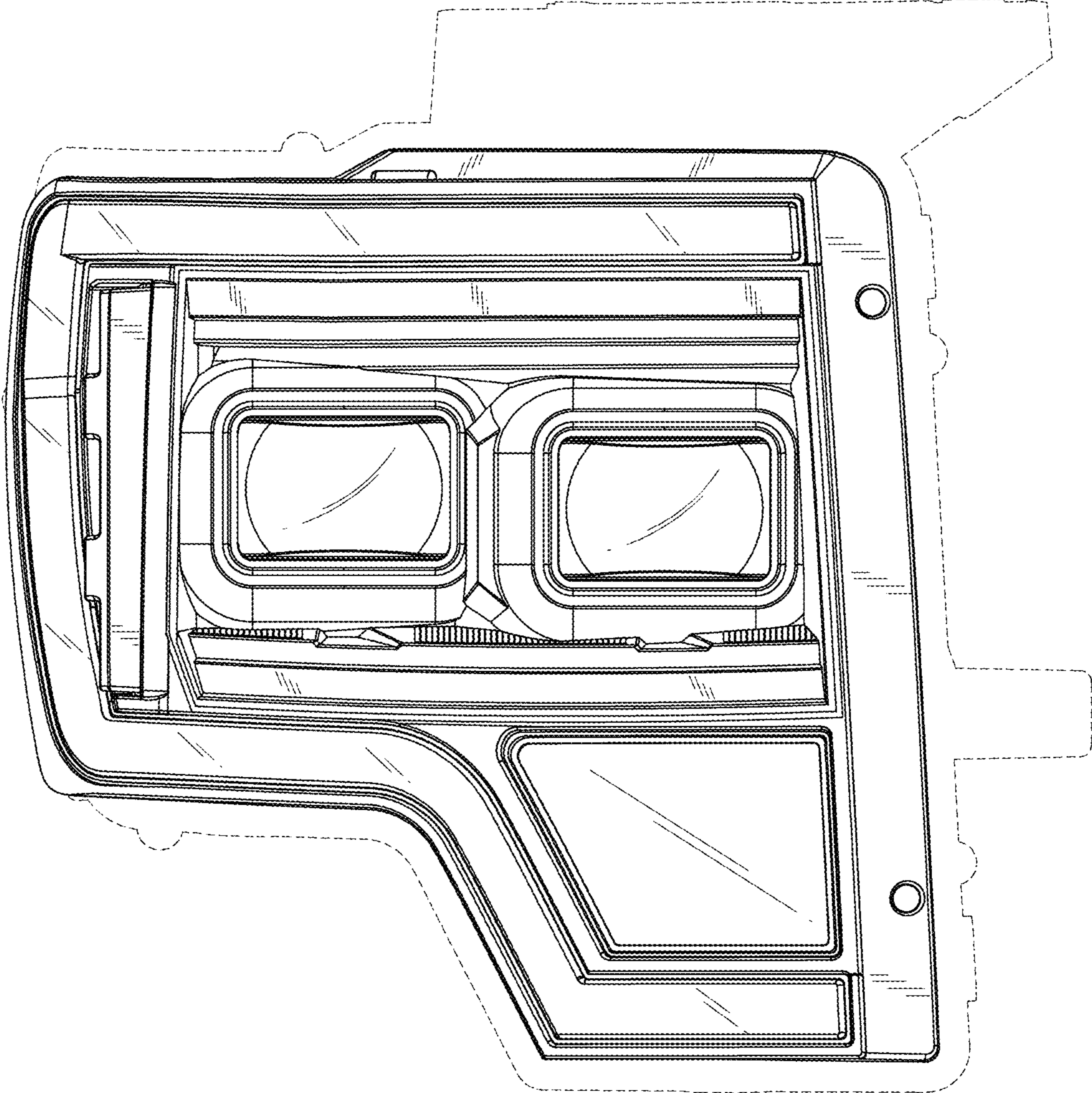

FIG. 2

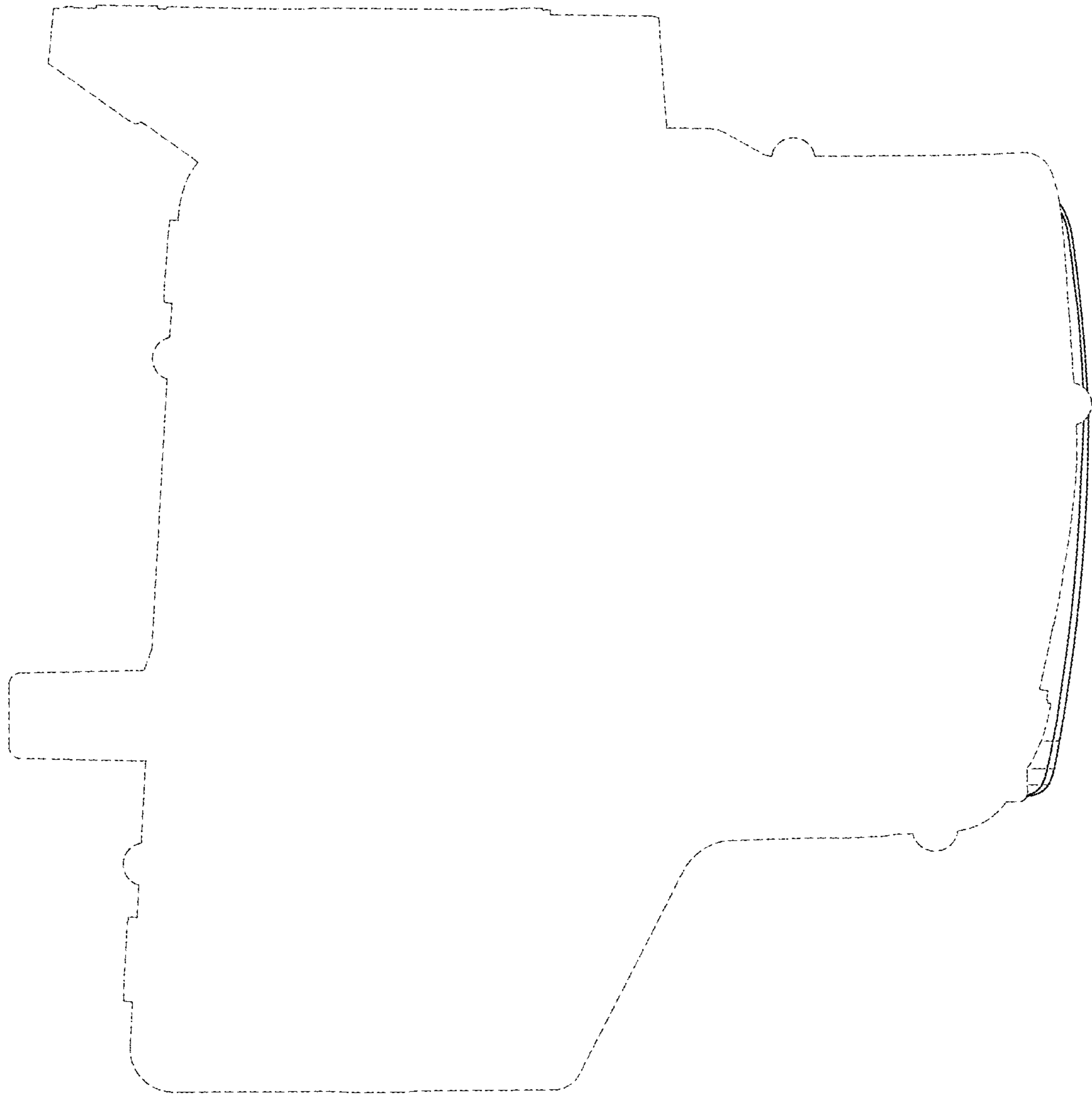

FIG. 3

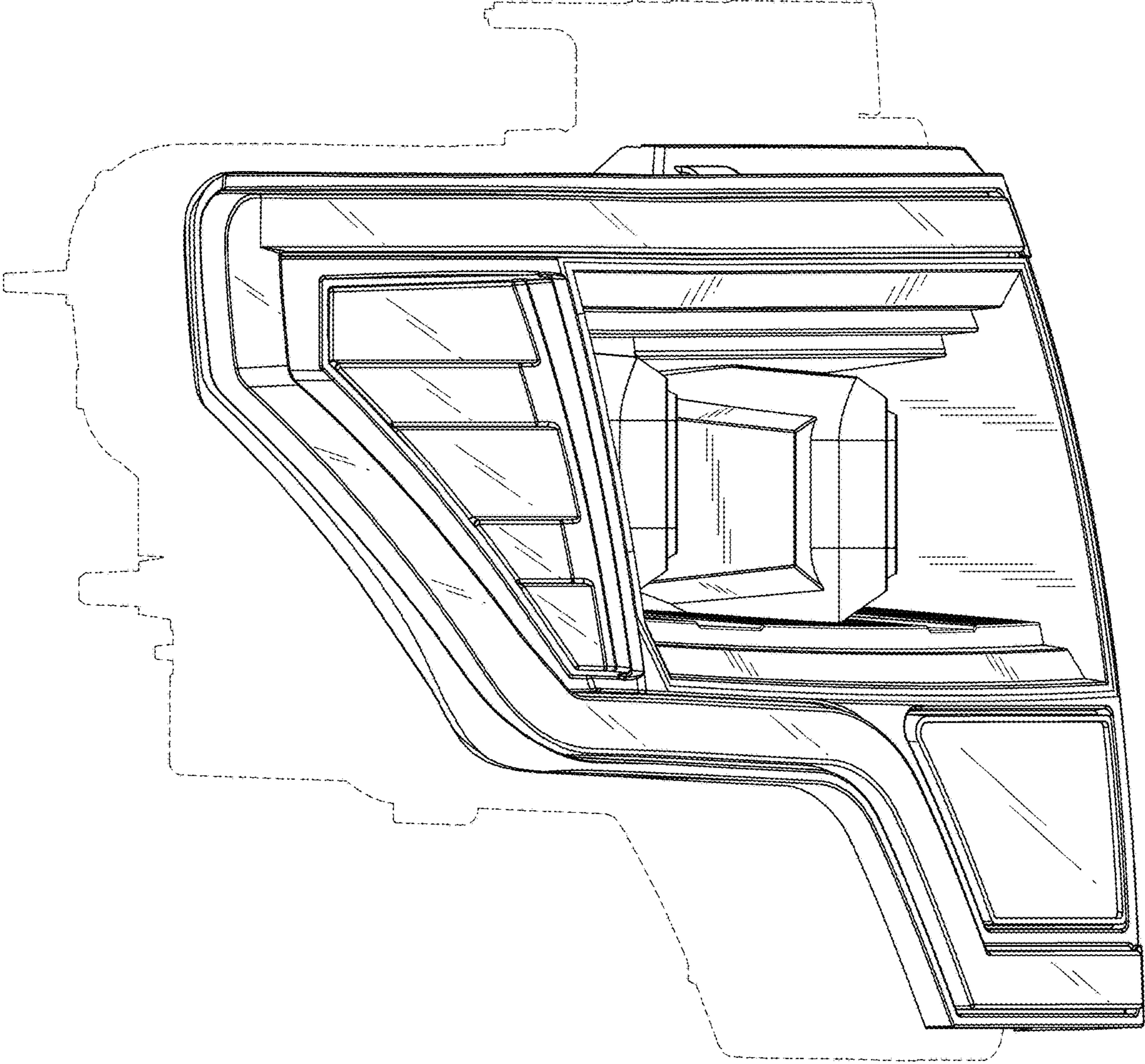

FIG. 4

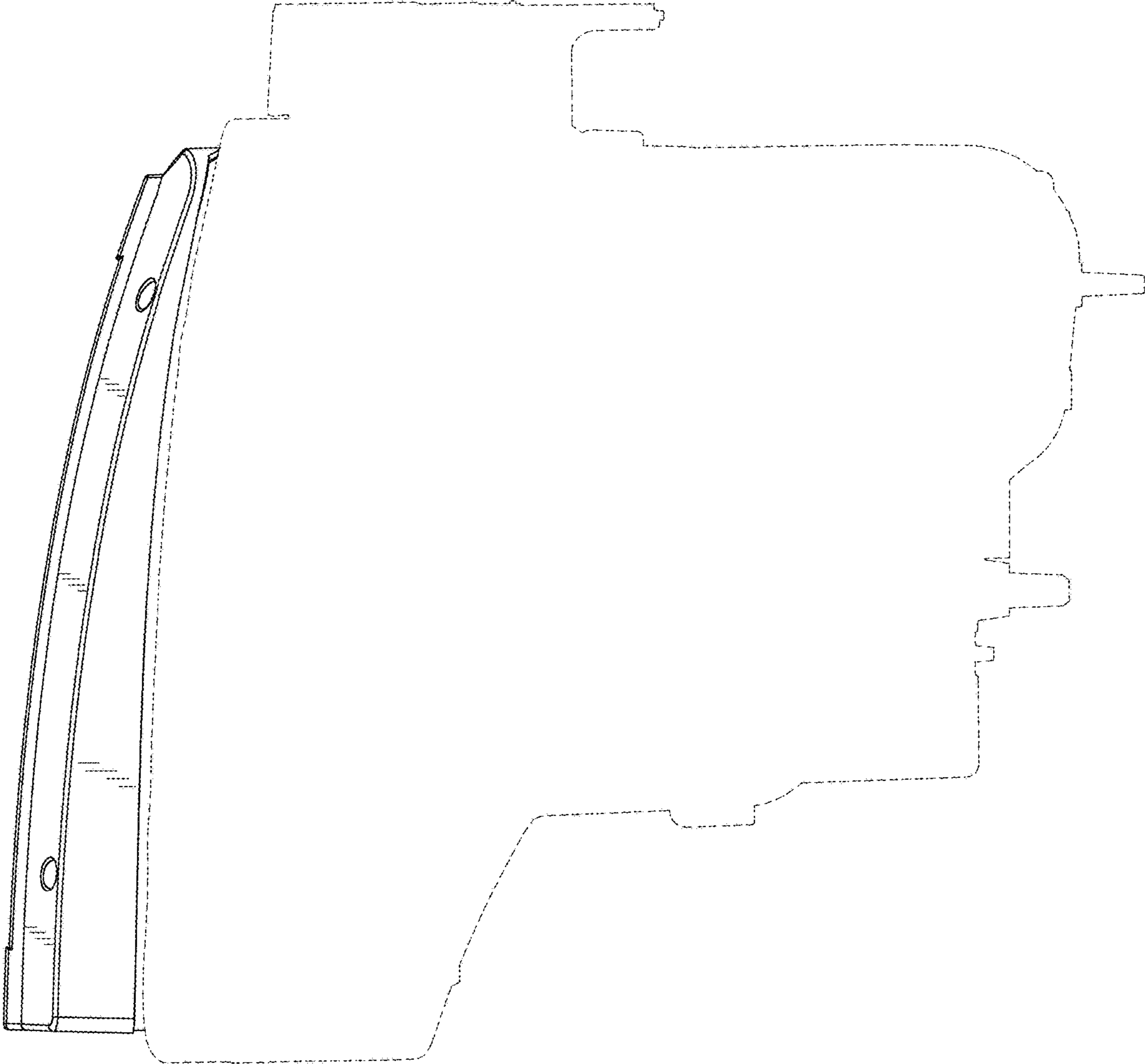

FIG. 5

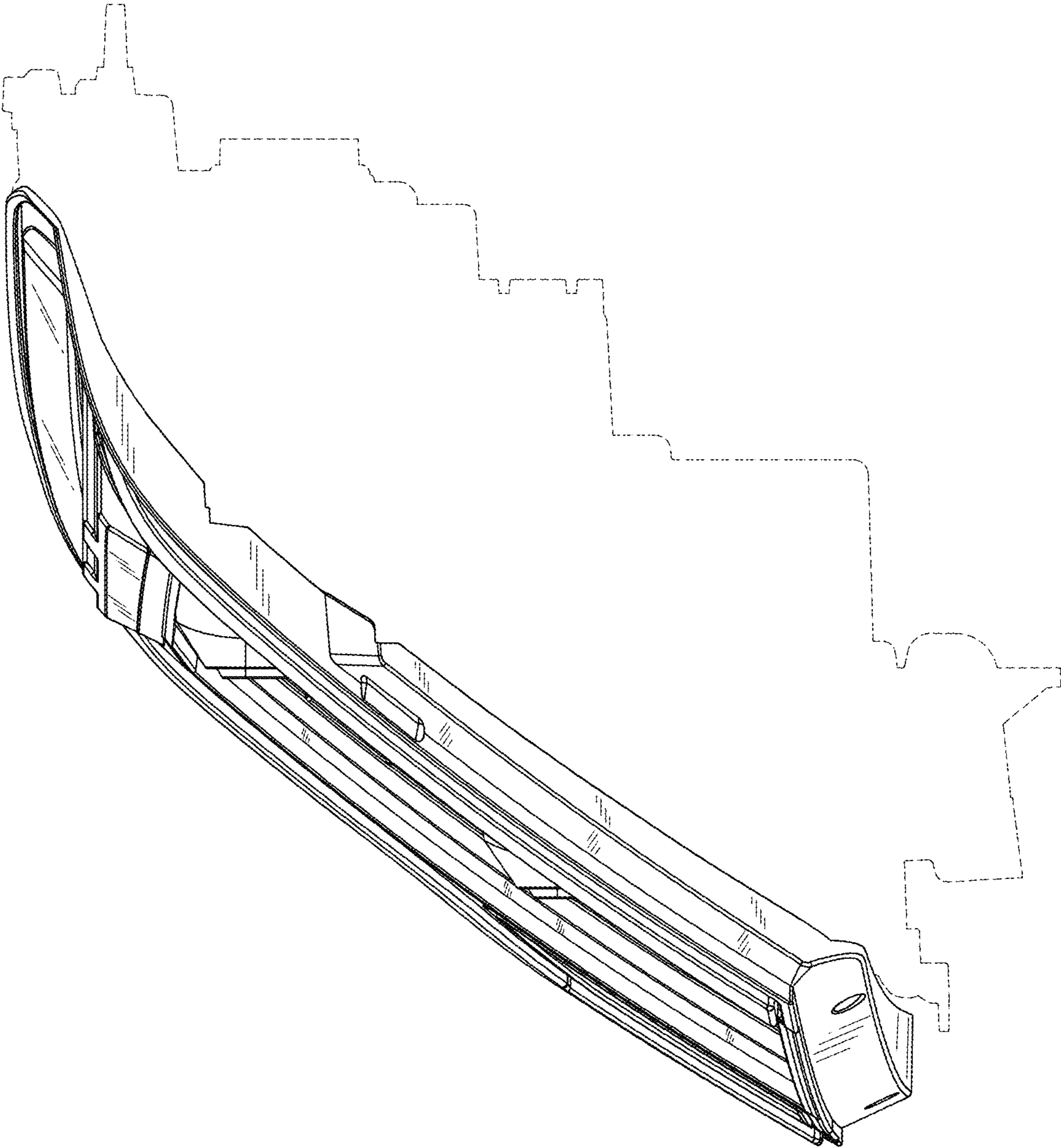

FIG. 6

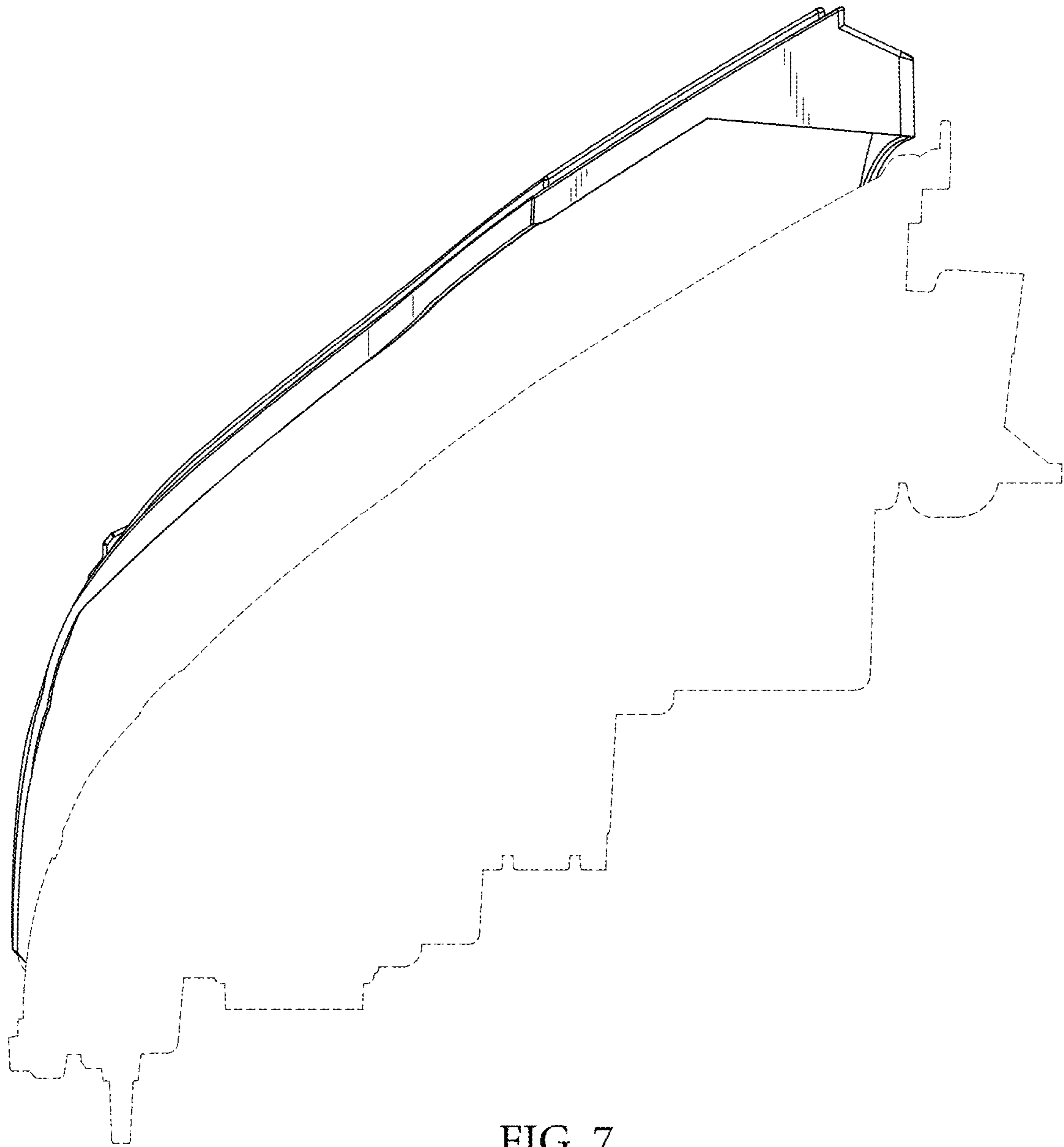

FIG. 7