



US00D930188S

(12) **United States Design Patent** (10) **Patent No.:** **US D930,188 S**  
**Xue** (45) **Date of Patent:** **\*\* Sep. 7, 2021**

(54) **INFLATABLE PAINT BOOTH**  
(71) Applicant: **Chao Xue**, Zhengzhou (CN)  
(72) Inventor: **Chao Xue**, Zhengzhou (CN)  
(\*\*) Term: **15 Years**  
(21) Appl. No.: **29/672,787**  
(22) Filed: **Dec. 10, 2018**  
(51) **LOC (13) Cl.** ..... **25-03**  
(52) **U.S. Cl.**  
USPC ..... **D25/18**; D21/835  
(58) **Field of Classification Search**  
USPC ..... D21/834, 835, 814, 811, 820; D25/18,  
D25/19, 33, 20  
CPC ... E04H 15/20; E04H 2015/201; E04H 15/22;  
A63B 2208/12  
See application file for complete search history.

(56) **References Cited**  
**U.S. PATENT DOCUMENTS**

3,154,888 A \* 11/1964 Graham ..... E04H 9/10  
D25/19  
3,497,606 A \* 2/1970 Andrews ..... E04H 15/20  
174/379  
D220,685 S \* 5/1971 Stineman ..... D25/18  
D300,649 S \* 4/1989 Tauer ..... D21/835  
D397,800 S \* 9/1998 Acevedo-Arjona ..... D25/18  
D439,946 S \* 4/2001 Gourchounian ..... D21/835  
D441,416 S \* 5/2001 Gourchounian ..... D21/820  
D509,877 S \* 9/2005 Peterson ..... D21/835  
D549,836 S \* 8/2007 Desbiens ..... D25/19  
D703,829 S \* 4/2014 Page ..... D25/33  
D876,566 S \* 2/2020 Jutras ..... D21/835  
2008/0020695 A1 \* 1/2008 Chang ..... B08B 15/026  
454/56

2015/0017338 A1 \* 1/2015 Williams ..... E04H 15/20  
427/421.1  
2017/0081867 A1 \* 3/2017 Wasson ..... E04H 15/20  
2020/0299984 A1 \* 9/2020 Williams ..... E04H 15/20

**OTHER PUBLICATIONS**

Inflatable Tent Used, Oct. 16, 2015, <http://www.inflatable-tent.co.uk/inflatable-tent-2/> (Year: 2015).  
Inflatable Structures. (Design—© Questel) orbit.com. [Online PDF compilation of references selected by examiner] 19 pgs. Print Dates Range 2003-2019 [Retrieved Apr. 21, 2021] <https://www.orbit.com/export/QPTUJ458/pdf2/c4c65a76-bc4c-4573-8979-331696e2c5ad-183633.pdf> (Year: 2021).  
Shane Conley, Mobile Paint Booth, Jul. 22, 2017, Youtube, <https://www.youtube.com/watch?v=ZpyobmR2xrA> (Year: 2017).\*

\* cited by examiner

*Primary Examiner* — Brett Miller  
(74) *Attorney, Agent, or Firm* — Rumit Ranjit Kanakia

(57) **CLAIM**

The ornamental design for inflatable paint booth, as shown and described.

**DESCRIPTION**

FIG. 1 is a front elevational view of inflatable paint booths; FIG. 2 is a back side elevational view thereof; FIG. 3 is a left view thereof. FIG. 4 is a right view thereof. FIG. 5 is a top view thereof; and, FIG. 6 is a bottom view thereof. The broken lines depict portions of the inflatable paint booth that form no part of the claimed design.

**1 Claim, 6 Drawing Sheets**

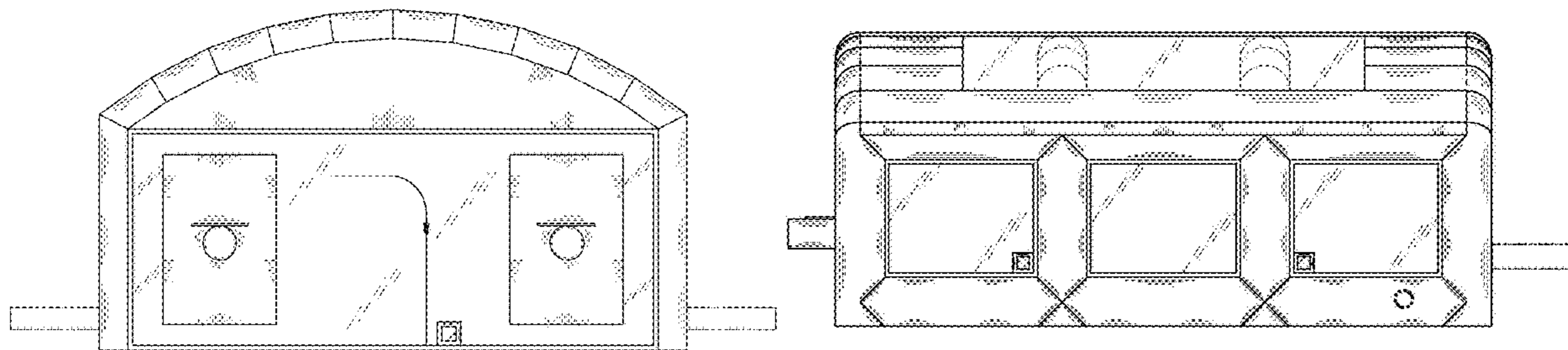

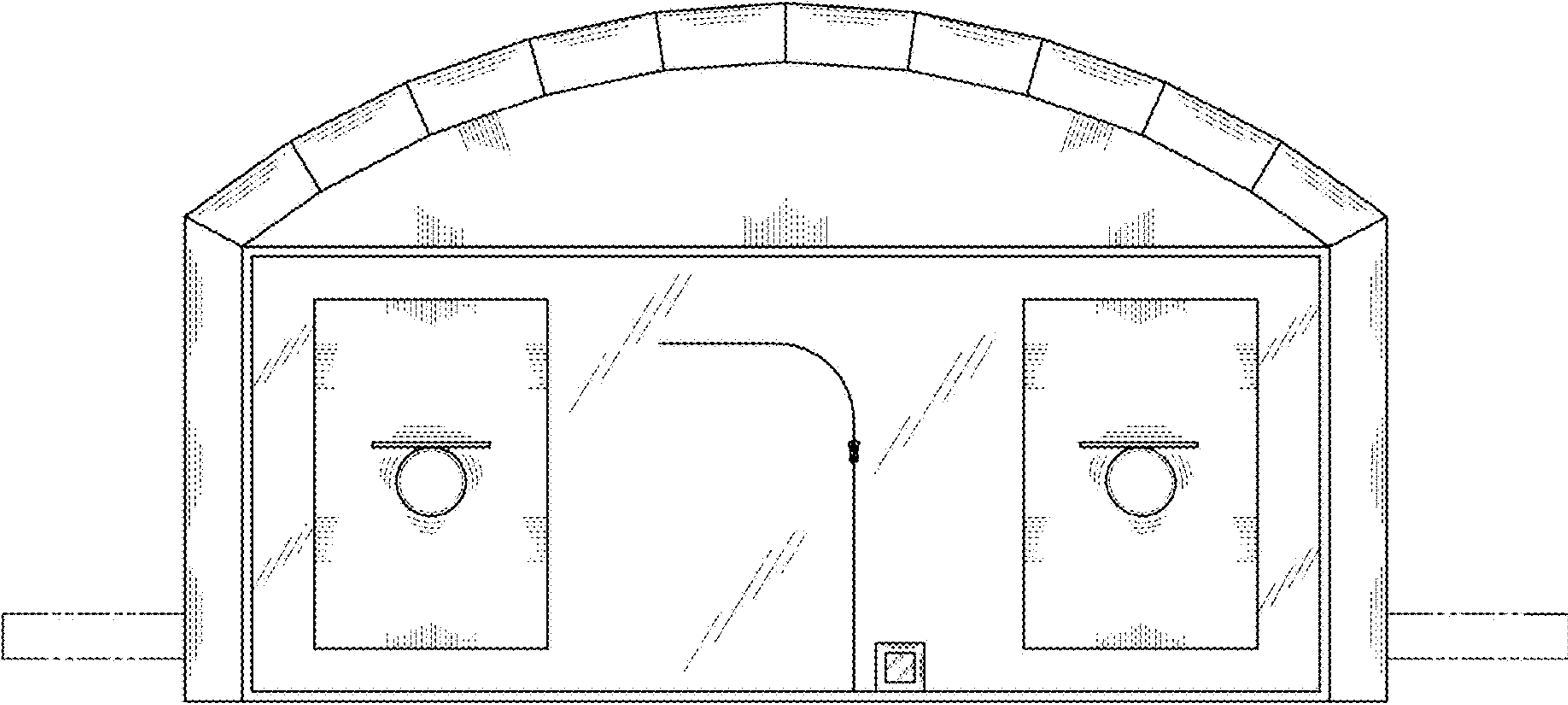

Fig.1

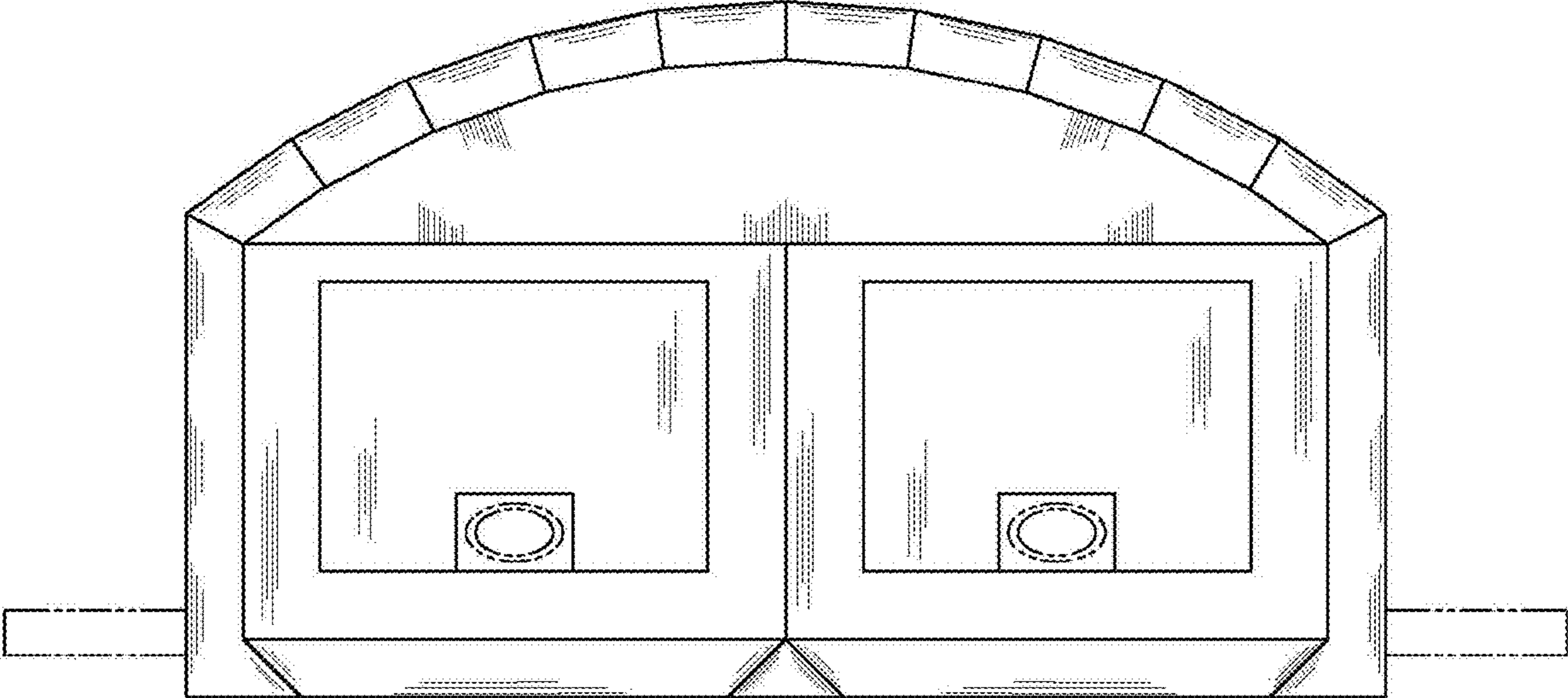

Fig.2

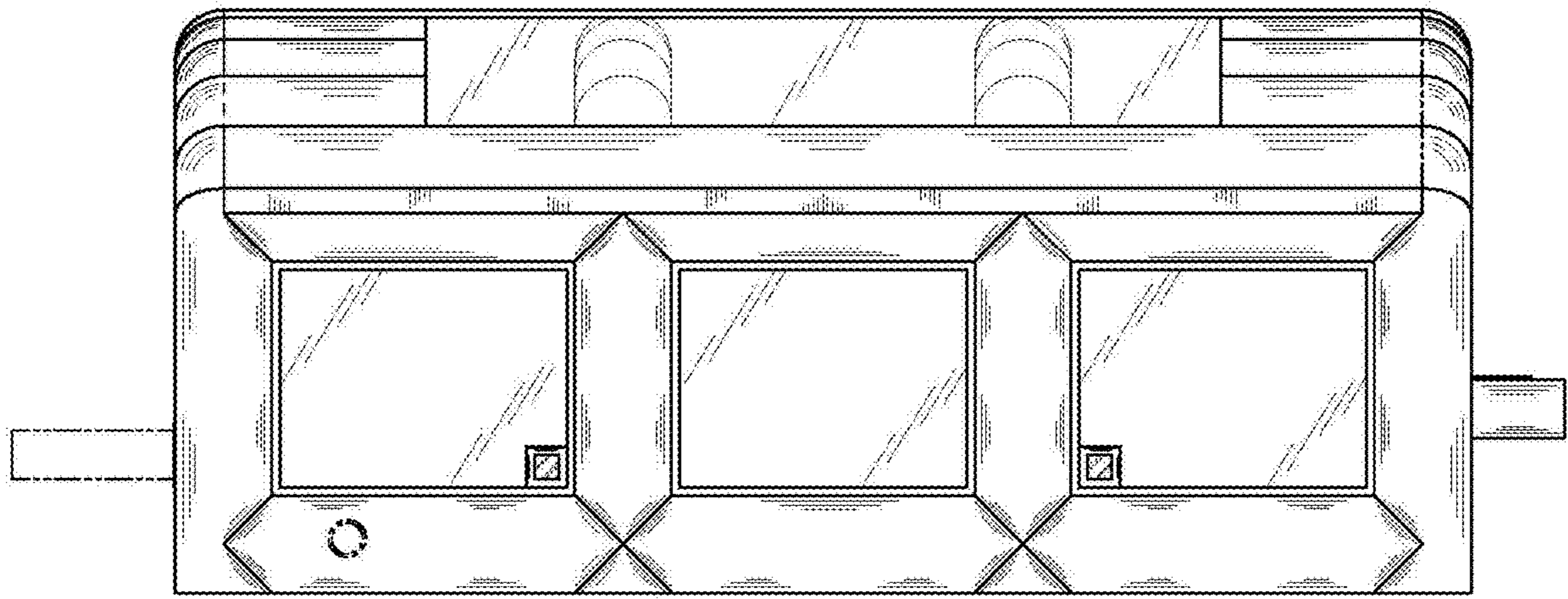

Fig.3

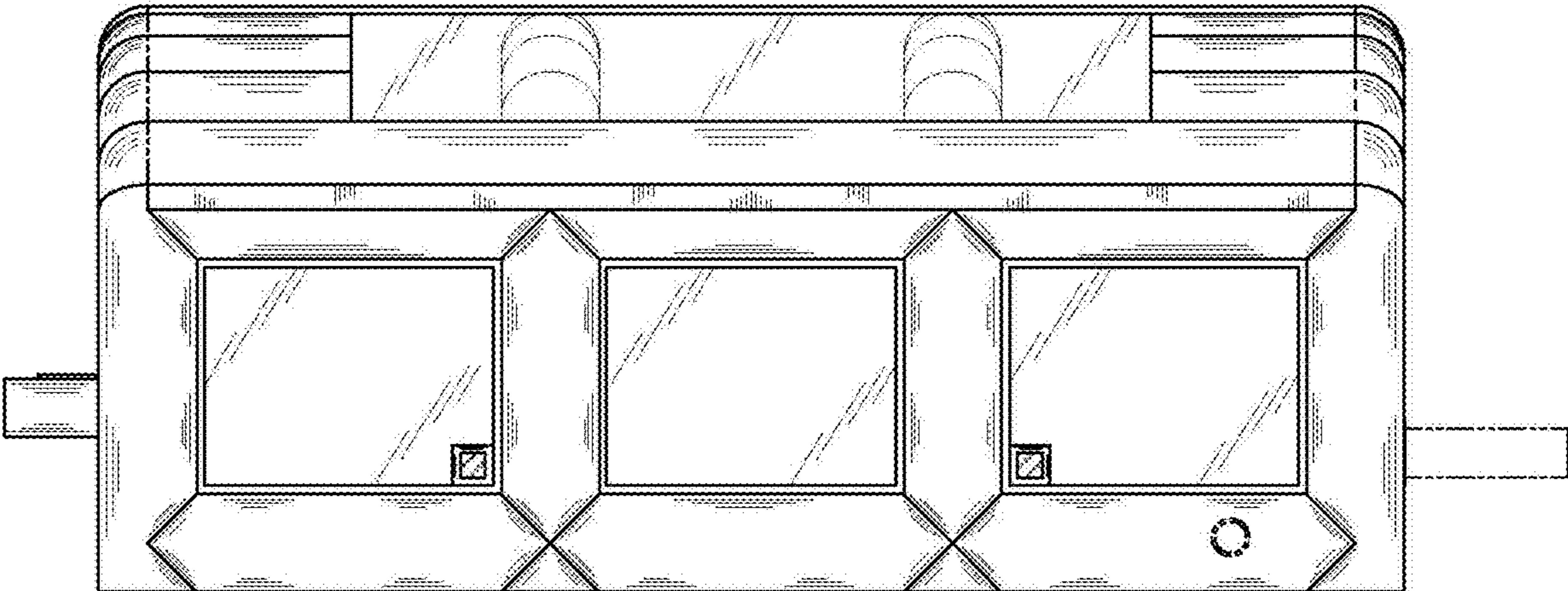

Fig.4

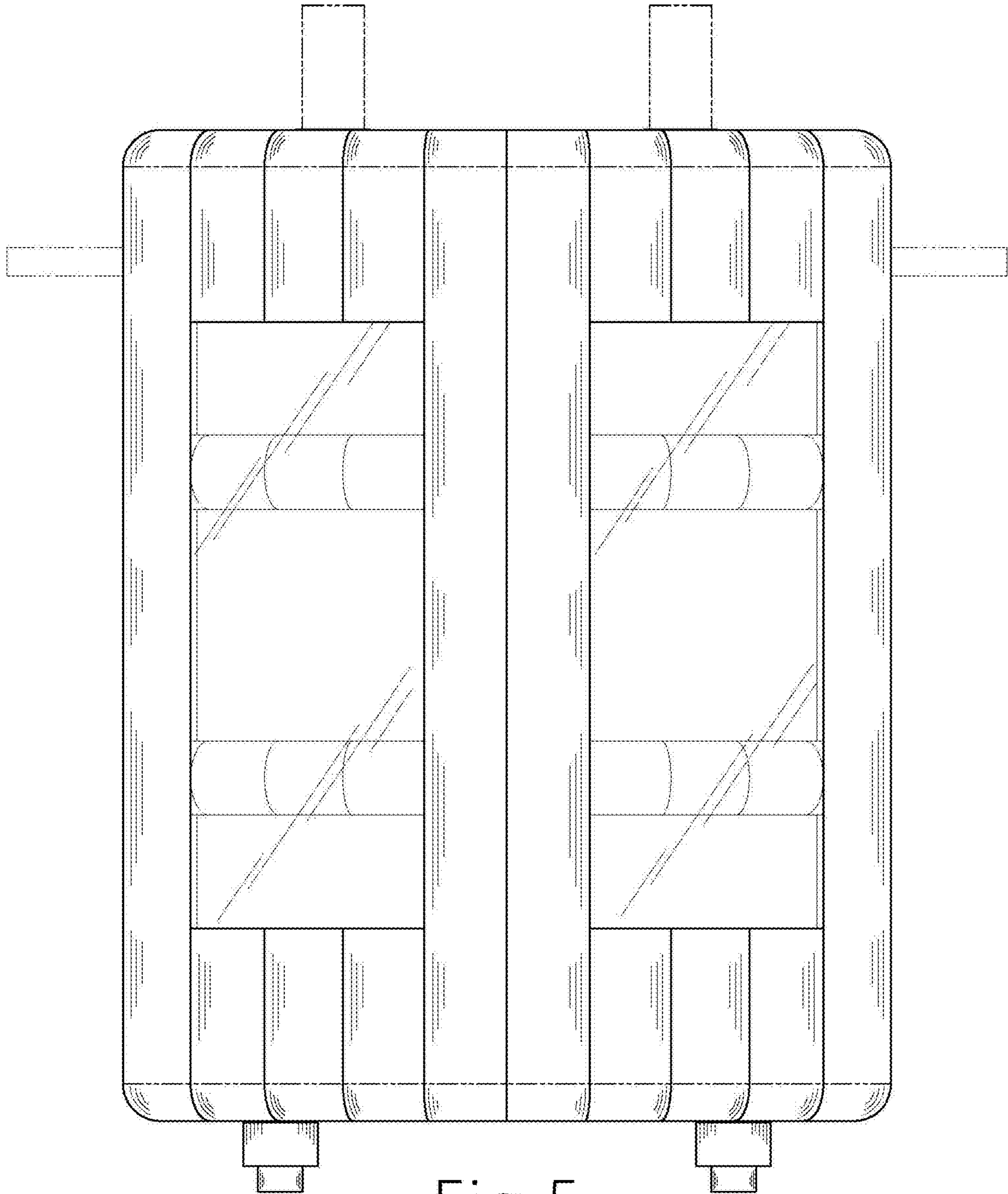

Fig.5

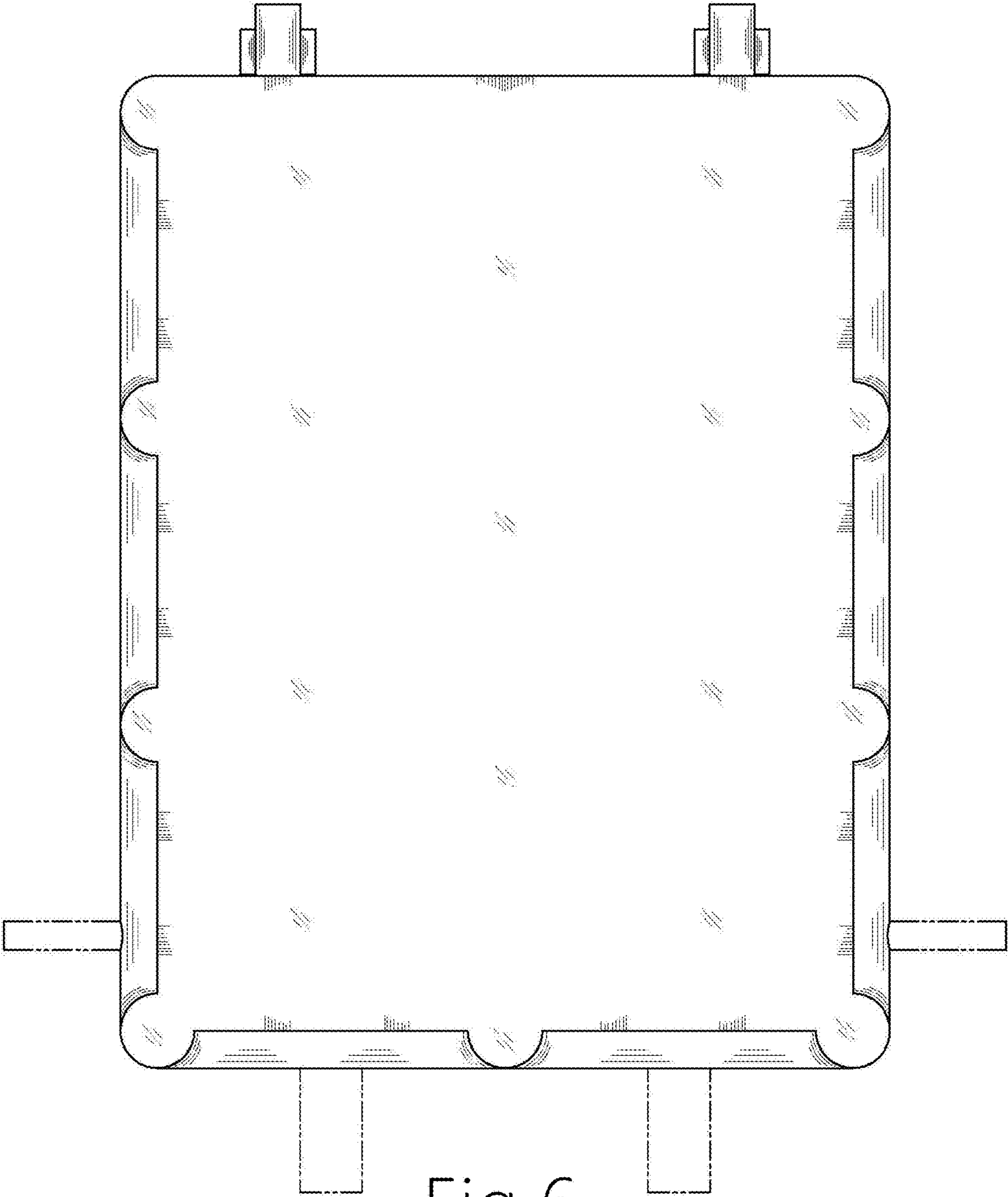

Fig.6