



US00D930100S

(12) **United States Design Patent** (10) **Patent No.:** **US D930,100 S**
Parsons et al. (45) **Date of Patent:** **** *Sep. 7, 2021**

(54) **GOLF CLUB HEAD**

CPC A63B 53/00; A63B 53/04; A63B 53/0466;
A63B 2053/002; A63B 2053/0445; A63B
2053/0433; A63B 60/00; A63B 60/46;
A63B 2053/0491; A63B 2053/0437
See application file for complete search history.

(71) Applicant: **PARSONS XTREME GOLF, LLC**,
Scottsdale, AZ (US)

(72) Inventors: **Robert R. Parsons**, Scottsdale, AZ
(US); **Bradley D. Schweigert**, Cave
Creek, AZ (US); **Michael R. Nicolette**,
Scottsdale, AZ (US)

(56) **References Cited**

U.S. PATENT DOCUMENTS

(73) Assignee: **PARSONS XTREME GOLF, LLC**,
Scottsdale, AZ (US)

1,133,129 A 3/1915 Govan
1,269,745 A 6/1918 Robertson
(Continued)

(*) Notice: This patent is subject to a terminal dis-
claimer.

OTHER PUBLICATIONS

(**) Term: **15 Years**

International Search Report and Written Opinion Received in Con-
nection With the Corresponding Application No. PCT/US2015/
016666, dated May 14, 2015 (8 Pages).

(21) Appl. No.: **29/702,967**

(Continued)

(22) Filed: **Aug. 22, 2019**

Primary Examiner — Mitchell I. Siegel

Related U.S. Application Data

(57) **CLAIM**

(60) Continuation-in-part of application No. 29/689,666,
filed on May 1, 2019, now Pat. No. Des. 897,464,
which is a division of application No. 29/661,121,
filed on Aug. 24, 2018, now Pat. No. Des. 850,551,
which is a continuation-in-part of application No.
29/646,576, filed on May 4, 2018, now abandoned,
and a continuation-in-part of application No.
29/646,582, filed on May 4, 2018, now abandoned,
and a continuation-in-part of application No.
29/645,048, filed on Apr. 23, 2018, now abandoned,
and a continuation-in-part of application No.
29/634,923, filed on Jan. 25, 2018, now abandoned,
(Continued)

The ornamental design for a golf club head, as shown and
described.

DESCRIPTION

(51) **LOC (13) Cl.** **21-02**

(52) **U.S. Cl.**
USPC **D21/759**

(58) **Field of Classification Search**
USPC D21/733, 752, 759

FIG. 1 is a top perspective view of a golf club head;
FIG. 2 is a bottom perspective view of the golf club head of
FIG. 1;
FIG. 3 is a front elevational view of the golf club head of
FIG. 1;
FIG. 4 is a rear elevational view of the golf club head of FIG.
1;
FIG. 5 is a top view of the golf club head of FIG. 1;
FIG. 6 is a bottom view of the golf club head of FIG. 1;
FIG. 7 is a left side view of the golf club head of FIG. 1; and,
FIG. 8 is a right side view of the golf club head of FIG. 1.
The broken line showing is included for the purpose of
illustrating unclaimed subject matter and forms no part of
the claimed design.

1 Claim, 7 Drawing Sheets

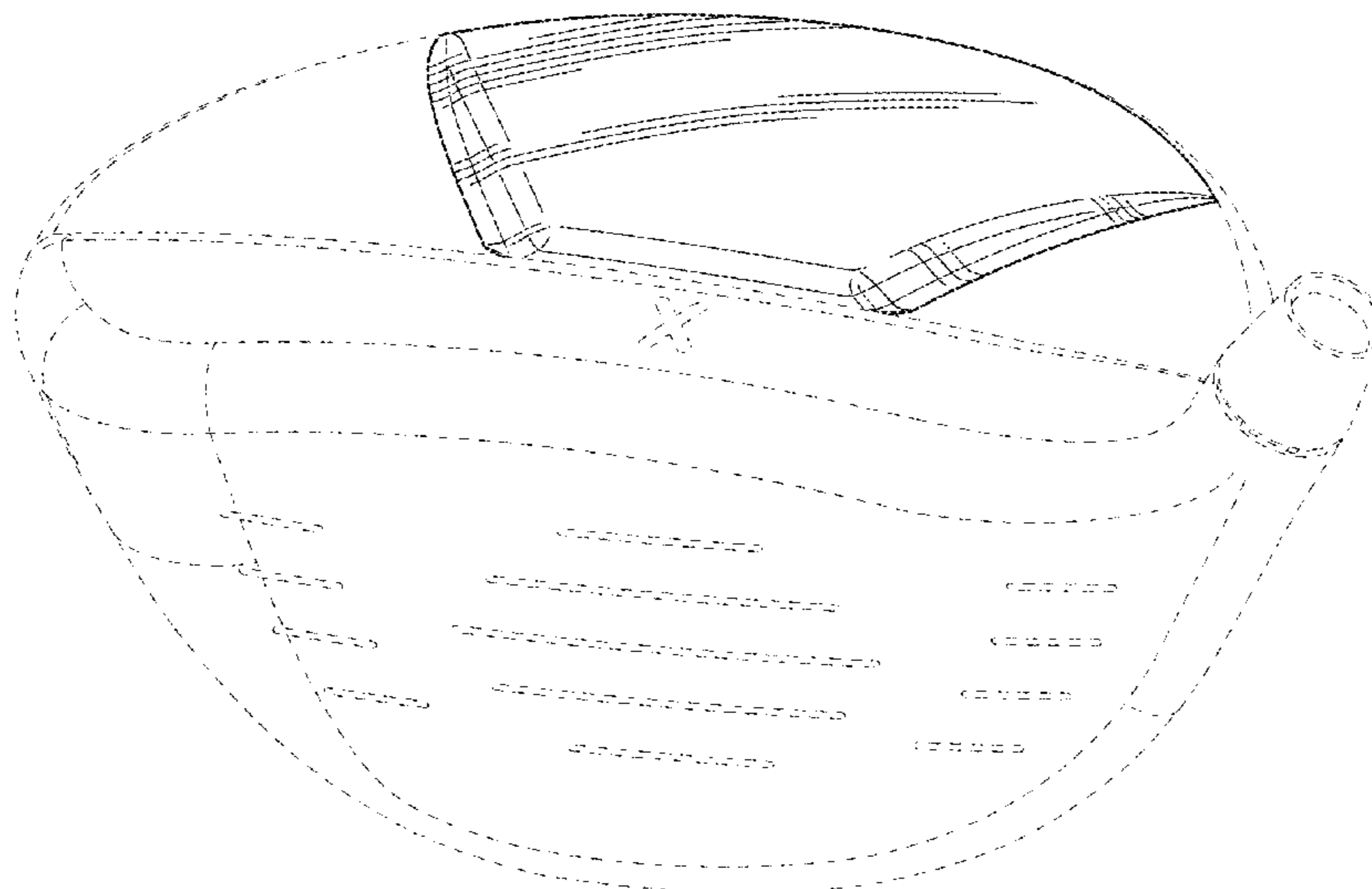

Related U.S. Application Data

and a continuation-in-part of application No. 29/628, 987, filed on Dec. 9, 2017, now Pat. No. Des. 839, 372, which is a continuation-in-part of application No. 29/616,688, filed on Sep. 7, 2017, now abandoned, and a continuation-in-part of application No. 29/628,986, filed on Dec. 9, 2017, now Pat. No. Des. 827,745, and a continuation-in-part of application No. 29/610,183, filed on Jul. 10, 2017, now abandoned.

(56)

References Cited

U.S. PATENT DOCUMENTS

1,306,029 A 6/1919 Robertson
D55,867 S 7/1920 Mattern
1,509,429 A 9/1924 Hillerich
1,534,600 A 4/1925 Mattern
1,538,312 A 5/1925 Beat
1,543,691 A 6/1925 Beat
1,774,590 A 9/1930 Buhrke
D94,549 S 2/1935 Jansky
D94,550 S 2/1935 Jansky
D138,438 S 6/1944 Link
D138,437 S 8/1944 Link
D138,439 S 8/1944 Link
D138,441 S 8/1944 Link
D138,442 S 8/1944 Link
D164,469 S 9/1951 Behrendt
D185,177 S 5/1959 Smith
3,020,048 A 2/1962 Carroll
D203,936 S 3/1966 Long
D215,101 S 9/1969 Sabat
3,556,553 A 1/1971 Kolbe
3,652,094 A 3/1972 Glover
D229,431 S 11/1973 Baker
D234,609 S 3/1975 Raymont
D234,610 S 3/1975 Raymont
D234,963 S 4/1975 Hirata
D239,550 S 4/1976 Timbrook
D240,054 S 5/1976 Meissler
D240,748 S 7/1976 Bock
D241,956 S 10/1976 Timbrook
4,085,934 A 4/1978 Churchward
D253,778 S 12/1979 Madison
D261,167 S 10/1981 Swanson
4,332,388 A 6/1982 Crow
D285,954 S 9/1986 Hasegawa
D294,617 S 3/1988 Perkins
4,754,977 A 7/1988 Sahn
4,824,116 A 4/1989 Nagamoto
D307,783 S 5/1990 Iinuma
D310,254 S * 8/1990 Take D21/752
4,988,104 A 1/1991 Shiotani
D326,885 S 6/1992 Paul
5,158,296 A 10/1992 Lee
5,176,384 A 1/1993 Sata
5,213,328 A 5/1993 Long
5,213,329 A 5/1993 Okumoto
D336,672 S 6/1993 Gorman
D336,935 S 8/1993 Antonious
D344,561 S 2/1994 Gorman
D351,883 S 10/1994 Serrano
D353,862 S 12/1994 Saito
D357,520 S 4/1995 Schmidt
5,419,560 A 5/1995 Bamber
5,425,535 A 6/1995 Gee
D361,358 S 8/1995 Simmons
5,447,311 A 9/1995 Viollaz
5,451,056 A 9/1995 Manning
D362,884 S 10/1995 Sheeley
D362,885 S 10/1995 Sheeley
D362,887 S 10/1995 Sheeley
5,518,243 A 5/1996 Redman
D370,514 S 6/1996 Sheeley
D371,816 S 7/1996 Yoshioka

5,540,437 A 7/1996 Bamber
D378,111 S 2/1997 Parente
5,637,045 A 6/1997 Igarashi
D384,120 S 9/1997 Parente
5,669,830 A 9/1997 Bamber
D389,541 S 1/1998 Huan-Chiang
D395,476 S 6/1998 Pond et al.
5,766,091 A 6/1998 Humphrey
5,766,092 A 6/1998 Mimeur
5,788,584 A 8/1998 Parente
D399,277 S 10/1998 Ezaki
5,827,132 A 10/1998 Bamber
D400,625 S 11/1998 Nicolette
D400,627 S 11/1998 Nicolette
D405,489 S 2/1999 Nicolette
D405,492 S 2/1999 Nicolette
D408,485 S 4/1999 Sasaki
5,899,821 A 5/1999 Hsu
5,935,016 A 8/1999 Antonious
D414,535 S 9/1999 Mertens
D421,080 S 2/2000 Chen
D426,276 S 6/2000 Besnard et al.
6,077,171 A 6/2000 Yoneyama
D442,659 S 5/2001 Solheim
D443,008 S 5/2001 Kubica
D444,830 S 7/2001 Nicolette
D445,862 S 7/2001 Ford
6,290,609 B1 9/2001 Takeda
D448,824 S 10/2001 Koizumi et al.
D449,866 S 10/2001 Miller
D457,211 S 5/2002 Bakke
D469,833 S 2/2003 Roberts
D473,604 S 4/2003 Antonious
D473,605 S 4/2003 Petersen
D475,107 S 5/2003 Madore
D476,048 S 6/2003 Cleveland
D478,140 S 8/2003 Burrows
D478,949 S 8/2003 De La Cruz
D481,087 S 10/2003 Antonious
6,638,182 B2 10/2003 Kosmatka
6,695,714 B1 2/2004 Bliss
6,702,693 B2 3/2004 Bamber
6,773,360 B2 8/2004 Willett
6,780,123 B2 8/2004 Hasebe
D497,963 S 11/2004 Toulon
6,811,496 B2 11/2004 Wahl
D499,779 S 12/2004 Mahaffey
D502,520 S * 3/2005 Dogan D21/759
D502,975 S 3/2005 Schweigert et al.
D503,204 S 3/2005 Nicolette et al.
D507,320 S 7/2005 Roberts et al.
D508,545 S 8/2005 Roberts et al.
D508,969 S 8/2005 Hasebe
6,923,733 B2 8/2005 Chen
6,939,247 B1 9/2005 Schweigert
D513,051 S 12/2005 Lorenz, Jr.
D514,179 S 1/2006 Chen
D514,183 S 1/2006 Schweigert
D514,185 S 1/2006 Barez et al.
D515,642 S 2/2006 Antonious
D516,650 S 3/2006 Stone
D518,863 S 4/2006 Nishitani
D520,585 S 5/2006 Hasebe
D520,586 S 5/2006 Bingman
D522,077 S 5/2006 Jertson
D522,601 S 6/2006 Schweigert et al.
D523,104 S 6/2006 Hasebe
D523,498 S 6/2006 Chen et al.
D523,501 S 6/2006 Schweigert
D523,917 S 6/2006 Roberts
D524,889 S 7/2006 Kim
D526,372 S 8/2006 Kohno
D526,694 S 8/2006 Jertson
7,121,956 B2 10/2006 Lo
7,128,663 B2 10/2006 Bamber
D532,474 S * 11/2006 Bennett A63B 53/04
D21/759
D534,595 S 1/2007 Hasebe
D534,599 S 1/2007 Beach

(56)

References Cited

U.S. PATENT DOCUMENTS

7,156,751 B2	1/2007	Wahl	7,717,805 B2	5/2010	Beach
7,166,040 B2	1/2007	Hoffman	D617,406 S	6/2010	Carlyle
D536,401 S	2/2007	Kawami	D618,293 S	6/2010	Foster et al.
D536,402 S	2/2007	Kawami	D618,746 S	6/2010	Jertson
D536,403 S	2/2007	Kawami	D618,747 S	6/2010	Chen
D537,495 S	2/2007	Nicolette	D618,753 S	6/2010	Jertson
7,182,698 B2	2/2007	Tseng	D618,754 S	6/2010	Schweigert et al.
D538,363 S	3/2007	Nicolette	7,744,484 B1	6/2010	Chao
D538,371 S	3/2007	Kawami	D621,893 S	8/2010	Nicolette
7,186,190 B1	3/2007	Beach	7,798,203 B2	9/2010	Schweigert
7,207,900 B2	4/2007	Nicolette	7,798,917 B2	9/2010	Nguyen
D543,601 S	5/2007	Kawami	7,815,521 B2	10/2010	Ban
7,223,180 B2	5/2007	Willett	7,846,040 B2	12/2010	Ban
D552,198 S	10/2007	Nicolette	7,846,041 B2	12/2010	Beach
D555,219 S	11/2007	Lin	D633,967 S	3/2011	Carlyle
D556,288 S	12/2007	Serrano	D635,626 S	4/2011	Nicolette
D557,363 S	12/2007	Serrano	7,927,229 B2	4/2011	Jertson
D558,287 S	12/2007	Serrano	D638,893 S	5/2011	Schweigert et al.
7,303,486 B2	12/2007	Imamoto	D638,896 S	5/2011	Schweigert et al.
D559,932 S	1/2008	Belmont	7,938,738 B2	5/2011	Roach
D561,284 S	2/2008	Nagai	D643,490 S	6/2011	Ban
D562,421 S	2/2008	Serrano	7,963,861 B2	6/2011	Beach
D563,498 S	3/2008	Jertson	8,012,038 B1	9/2011	Beach
D564,054 S	3/2008	Jertson	D647,585 S	10/2011	Jertson et al.
D564,055 S	3/2008	Jertson	8,062,150 B2	11/2011	Gilbert
7,338,388 B2	3/2008	Schweigert	8,088,025 B2	1/2012	Wahl
7,347,794 B2	3/2008	Schweigert	8,092,319 B1	1/2012	Cackett
D567,317 S	4/2008	Jertson et al.	8,105,180 B1	1/2012	Cackett
7,351,164 B2	4/2008	Schweigert	D658,248 S	4/2012	Toulon
D569,933 S	5/2008	Jertson	D661,751 S	6/2012	Jertson
D569,934 S	5/2008	Jertson et al.	D661,756 S	6/2012	Jertson
D569,935 S	5/2008	Chen	8,221,262 B1	7/2012	Cackett
D569,936 S	5/2008	Chen	8,246,487 B1	8/2012	Cackett
D569,942 S	5/2008	Jertson	8,257,196 B1	9/2012	Abbott
D570,937 S	6/2008	Chen	8,257,197 B2	9/2012	Schweigert
D570,938 S	6/2008	Jertson	8,262,506 B2	9/2012	Watson
7,396,299 B2	7/2008	Nicolette	8,328,662 B2	12/2012	Nakamura
7,407,447 B2	8/2008	Beach	D673,630 S	1/2013	Schweigert
7,410,425 B2	8/2008	Willett	D673,632 S	1/2013	Chen
7,410,426 B2	8/2008	Willett	8,371,957 B2	2/2013	Schweigert
7,419,441 B2	9/2008	Hoffman	8,376,878 B2	2/2013	Bennett
D579,507 S	10/2008	Llewellyn	D680,179 S	4/2013	Chen
7,448,963 B2	11/2008	Beach	D681,142 S	4/2013	Fossum et al.
7,448,964 B2	11/2008	Schweigert	8,414,422 B2	4/2013	Peralta
D584,370 S	1/2009	Cleveland	8,485,919 B2	7/2013	Rice
D584,782 S *	1/2009	Barez D21/759	8,506,420 B2	8/2013	Hocknell
D584,783 S *	1/2009	Barez D21/759	D689,156 S	9/2013	Schweigert
D584,784 S *	1/2009	Barez D21/759	D691,230 S	10/2013	Jertson
7,530,904 B2	5/2009	Beach	8,545,343 B2	10/2013	Boyd
D594,518 S	6/2009	Schweigert	8,562,457 B2	10/2013	Beach
D594,520 S	6/2009	Chen	8,574,094 B2	11/2013	Nicolette
D594,521 S	6/2009	Jertson	8,608,587 B2	12/2013	Henrikson
D594,919 S	6/2009	Chen	8,628,431 B2	1/2014	Schweigert
7,540,811 B2	6/2009	Beach	8,657,700 B2	2/2014	Nicolette
D597,620 S	8/2009	Toulon	8,663,026 B2	3/2014	Blowers
7,568,985 B2	8/2009	Beach	8,690,710 B2	4/2014	Nicolette
7,578,753 B2	8/2009	Beach	D707,316 S	6/2014	Brunski
D600,297 S	9/2009	Jertson	D707,317 S	6/2014	Brunski
7,584,531 B2	9/2009	Schweigert	8,753,230 B2	6/2014	Stokke
7,588,502 B2	9/2009	Nishino	8,777,778 B2	7/2014	Solheim
7,591,738 B2	9/2009	Beach	8,784,232 B2	7/2014	Jertson
D603,472 S	11/2009	Chen	8,790,196 B2	7/2014	Solheim
D604,783 S	11/2009	Solheim	8,808,108 B2	8/2014	Schweigert
7,611,424 B2	11/2009	Nagai	D712,989 S	9/2014	Gillig
7,621,823 B2	11/2009	Beach	8,826,512 B2	9/2014	Schweigert
D605,715 S	12/2009	Toulon	8,827,832 B2	9/2014	Breier
D606,605 S	12/2009	Ban	8,827,833 B2	9/2014	Amano
D607,070 S	12/2009	Ban	8,845,455 B2	9/2014	Ban
D607,071 S	12/2009	Ban	D714,894 S	10/2014	Tang
7,632,194 B2	12/2009	Beach	D716,387 S	10/2014	Brunski
7,658,686 B2	2/2010	Soracco	D716,388 S	10/2014	Brunski
D612,438 S	3/2010	Carlyle	8,858,362 B1	10/2014	Leposky
D612,439 S	3/2010	Carlyle	D721,544 S	1/2015	Hollander
7,713,142 B2	5/2010	Hoffman	D722,352 S	2/2015	Nicolette et al.
7,717,804 B2	5/2010	Beach	D723,120 S	2/2015	Nicolette
			8,961,336 B1	2/2015	Parsons
			D724,164 S	3/2015	Schweigert et al.
			8,979,671 B1	3/2015	DeMille
			D726,265 S	4/2015	Nicolette

(56)

References Cited

U.S. PATENT DOCUMENTS

D729,892 S 5/2015 Nicolette
 D733,234 S 6/2015 Nicolette
 9,199,140 B1 12/2015 Schweigert
 9,199,143 B1 12/2015 Parsons
 D746,927 S 1/2016 Parsons
 D748,214 S 1/2016 Nicolette et al.
 D748,749 S 2/2016 Nicolette et al.
 D753,251 S 4/2016 Schweigert
 D755,319 S 5/2016 Schweigert
 D756,471 S 5/2016 Schweigert
 9,352,197 B2 5/2016 Parsons
 D759,178 S 6/2016 Nicolette
 D760,334 S 6/2016 Schweigert
 9,399,158 B2 7/2016 Parsons
 9,421,437 B2 8/2016 Parsons
 9,427,634 B2 8/2016 Parsons
 D765,808 S * 9/2016 Cardani D21/759
 D766,391 S * 9/2016 Cardani D21/759
 D767,696 S 9/2016 Parsons
 D776,216 S 1/2017 Nicolette
 D777,858 S 1/2017 Nicolette
 9,555,295 B2 1/2017 Schweigert
 9,630,070 B2 4/2017 Parsons
 D791,257 S * 7/2017 Oldknow D21/759
 D802,069 S 11/2017 Parsons
 D802,070 S 11/2017 Parsons
 D807,976 S 1/2018 Parsons
 D821,514 S * 6/2018 Sillies D21/759
 D827,067 S 8/2018 Becktor
 D827,745 S 9/2018 Parsons
 D850,551 S * 6/2019 Parsons D21/759
 D852,303 S * 6/2019 Parsons D21/752
 D852,304 S * 6/2019 Parsons D21/752
 D852,305 S * 6/2019 Parsons D21/752
 D865,886 S * 11/2019 Parsons D21/752
 D897,462 S * 9/2020 Parsons D21/752
 D897,463 S * 9/2020 Parsons D21/752
 2002/0107087 A1 8/2002 Fagot
 2003/0139226 A1 7/2003 Cheng
 2003/0176231 A1 9/2003 Hasebe
 2004/0204263 A1 10/2004 Fagot
 2005/0009632 A1 1/2005 Schweigert
 2005/0014573 A1 1/2005 Lee
 2005/0119066 A1 6/2005 Stites
 2005/0239569 A1 10/2005 Best
 2005/0277485 A1 12/2005 Hou
 2006/0105856 A1 5/2006 Lo
 2006/0111200 A1 5/2006 Poynor
 2007/0032308 A1 2/2007 Fagot
 2007/0149310 A1 * 6/2007 Bennett A63B 53/0466
 473/328
 2007/0149315 A1 * 6/2007 Bennett A63B 60/02
 473/334
 2007/0225084 A1 9/2007 Schweigert
 2007/0293344 A1 12/2007 Davis
 2008/0004133 A1 1/2008 Schweigert
 2008/0058113 A1 3/2008 Nicolette
 2008/0188322 A1 8/2008 Anderson
 2008/0300065 A1 12/2008 Schweigert

2009/0029790 A1 1/2009 Nicolette
 2009/0029795 A1 1/2009 Schweigert
 2010/0130306 A1 5/2010 Schweigert
 2010/0144461 A1 6/2010 Ban
 2010/0178999 A1 7/2010 Nicolette
 2011/0111883 A1 5/2011 Cackett
 2011/0143858 A1 6/2011 Peralta
 2011/0165963 A1 7/2011 Cackett
 2011/0269567 A1 11/2011 Ban
 2011/0294596 A1 12/2011 Ban
 2012/0202615 A1 8/2012 Beach
 2012/0302367 A1 * 11/2012 Myrhum A63B 60/02
 473/324
 2013/0137532 A1 5/2013 Deshmukh
 2013/0225319 A1 8/2013 Kato
 2013/0244808 A1 * 9/2013 Bennett A63B 53/0466
 473/335
 2013/0281226 A1 10/2013 Ban
 2013/0288823 A1 10/2013 Hebreo
 2013/0303303 A1 11/2013 Ban
 2013/0303304 A1 11/2013 Sato
 2013/0310192 A1 11/2013 Wahl
 2014/0080621 A1 3/2014 Nicolette
 2014/0128175 A1 5/2014 Jertson
 2014/0274441 A1 9/2014 Greer
 2014/0274451 A1 9/2014 Knight
 2015/0231454 A1 8/2015 Parsons
 2015/0231806 A1 8/2015 Parsons
 2017/0165533 A1 * 6/2017 Knutson A63B 53/0466
 2017/0165534 A1 * 6/2017 Sanchez A63B 60/02
 2017/0165536 A1 * 6/2017 Yi A63B 53/0466
 2017/0165537 A1 * 6/2017 Murphy A63B 53/04
 2017/0165538 A1 * 6/2017 Cleghorn A63B 53/0466
 2017/0252614 A1 * 9/2017 Yi A63B 53/0466
 2017/0354852 A1 * 12/2017 Bennett A63B 60/02
 2018/0099189 A1 * 4/2018 Sanchez A63B 53/04
 2018/0326268 A1 * 11/2018 Yi A63B 60/04
 2019/0314690 A1 * 10/2019 Schweigert A63B 60/006
 2020/0215397 A1 * 7/2020 Parsons A63B 60/02
 2020/0230471 A1 * 7/2020 Parsons A63B 53/04

OTHER PUBLICATIONS

International Search Report and Written Opinion Received in Connection With the Corresponding Application No. PCT/US15/42484, dated Oct. 19, 2015 (12 Pages).
 International Search Report and Written Opinion Received in Connection With the Corresponding Application No. PCTUS2015042282, dated Oct. 13, 2015 (12 Pages).
 Kozuchowski, Zak, "Callaway Mack Daddy 2 PM Grind Wedges" (<http://golfwrz.com/276203/callaway-mack-daddy-2-pm-grind-wedges/>), www.golfwrz.com, Golfwrz Holdings, LLC, Published Jan. 21, 2015.
 Wall, Jonathan, "Details: Phil's Prototype Mack Daddy PM—Grind Wedge," (<http://www.pgatour.com/equipmentreport/2015/01/21/callaway-wedge.html>), www.pgatour.com, PGA Tour, Inc., Published Jan. 21, 2015.
 U.S. Appl. No. 29/512,313, Nicolette, "Golf Club Head," filed Dec. 18, 2018.

* cited by examiner

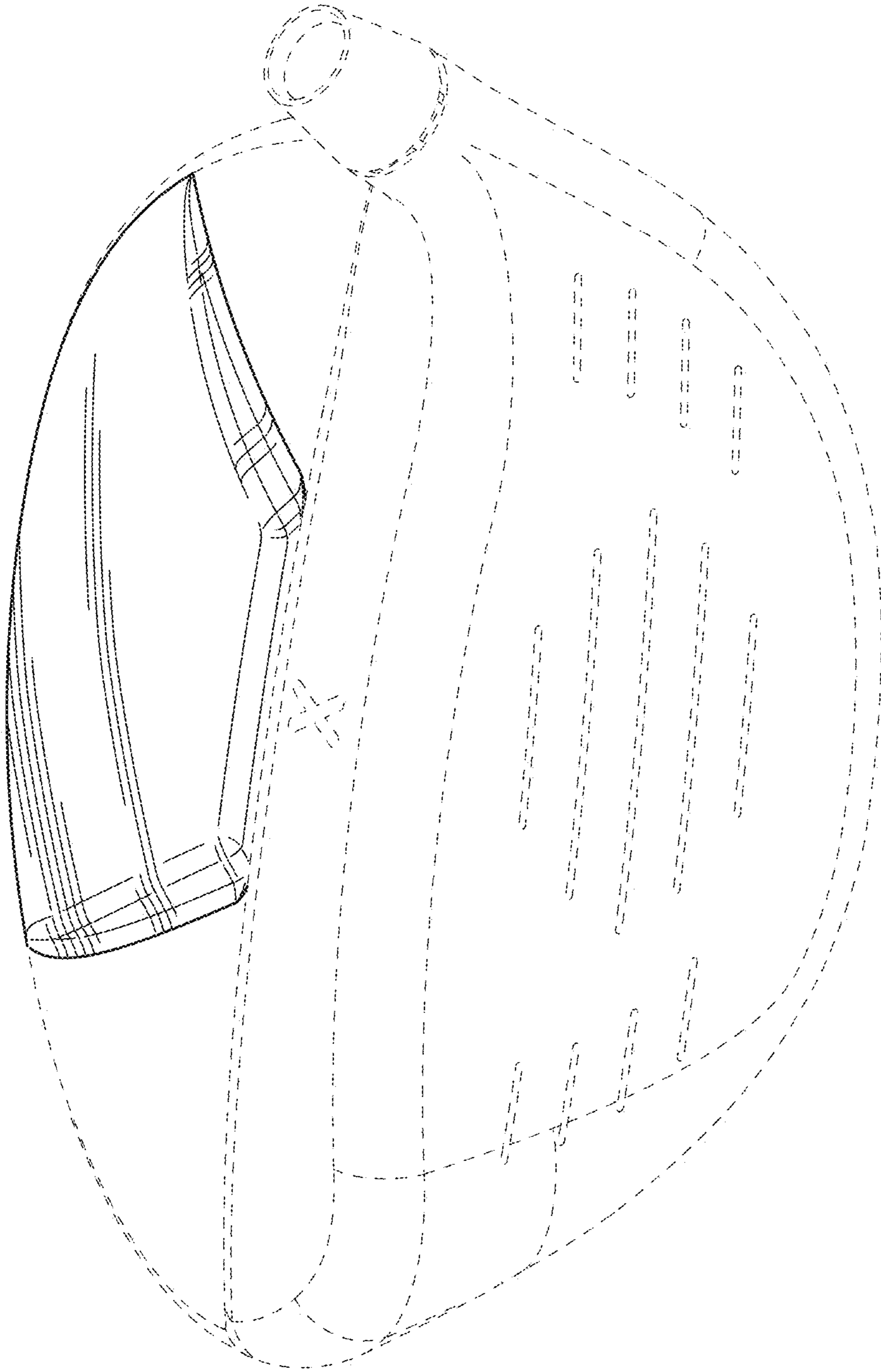

FIG. 1

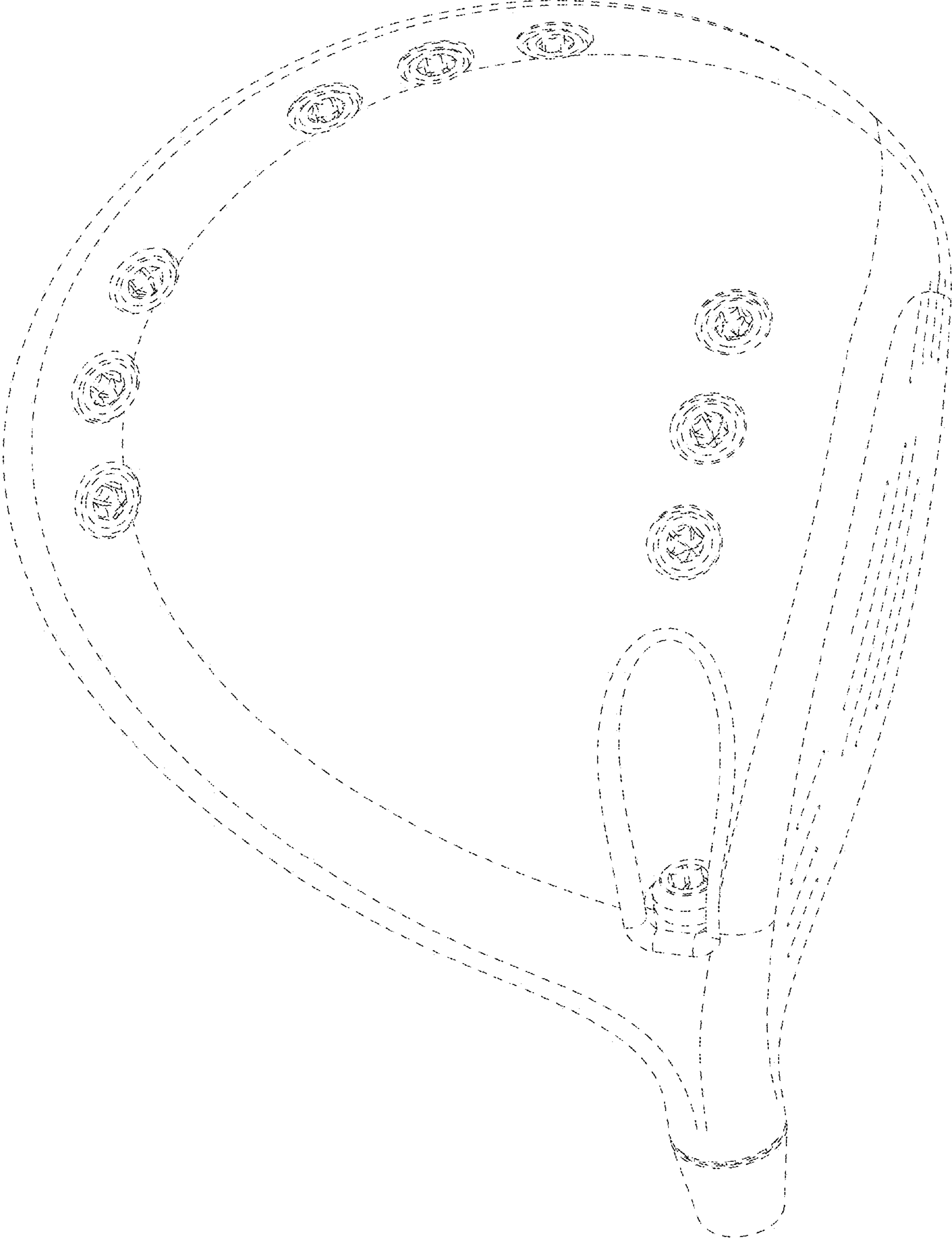

FIG. 2

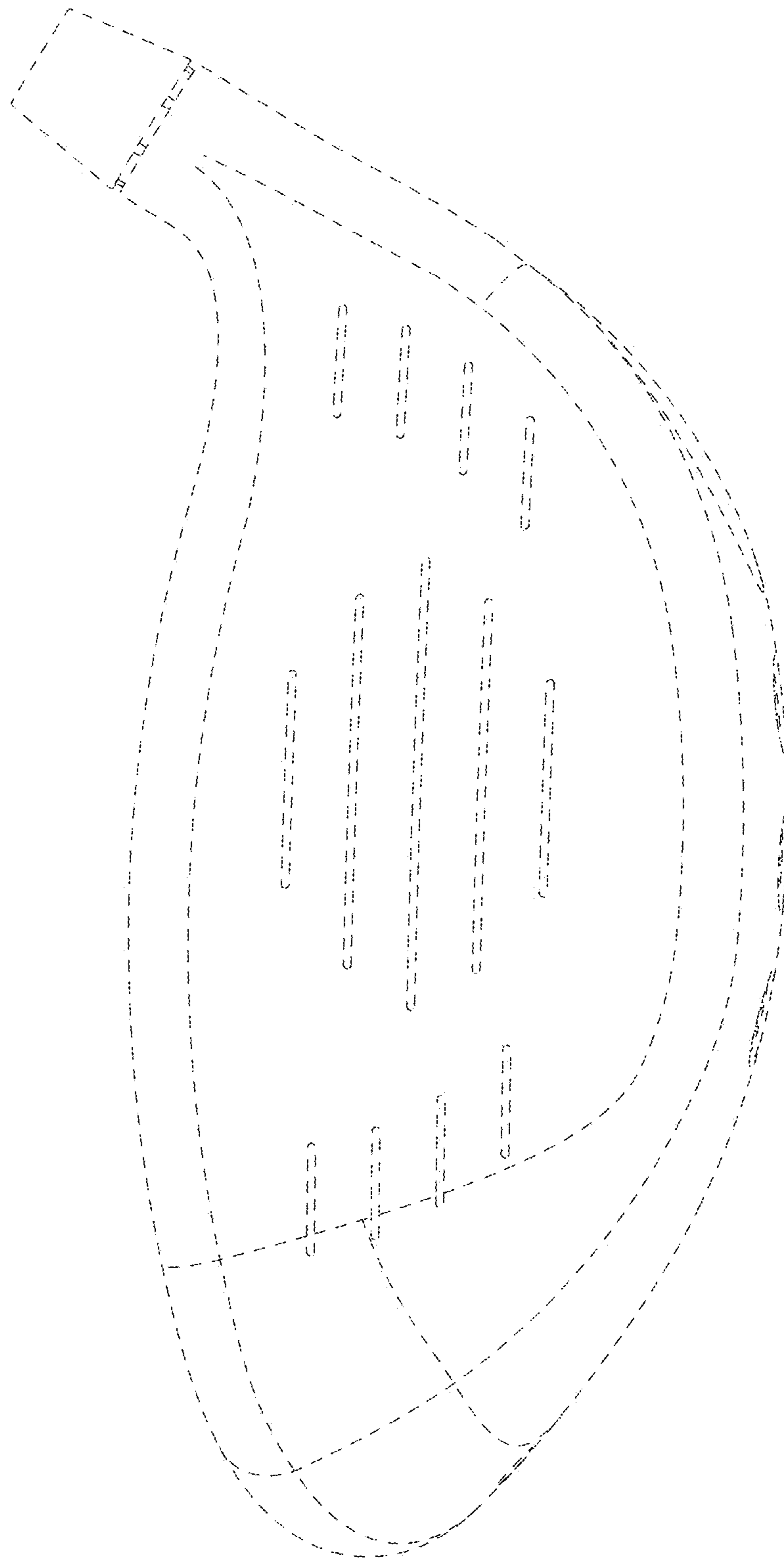

FIG. 3

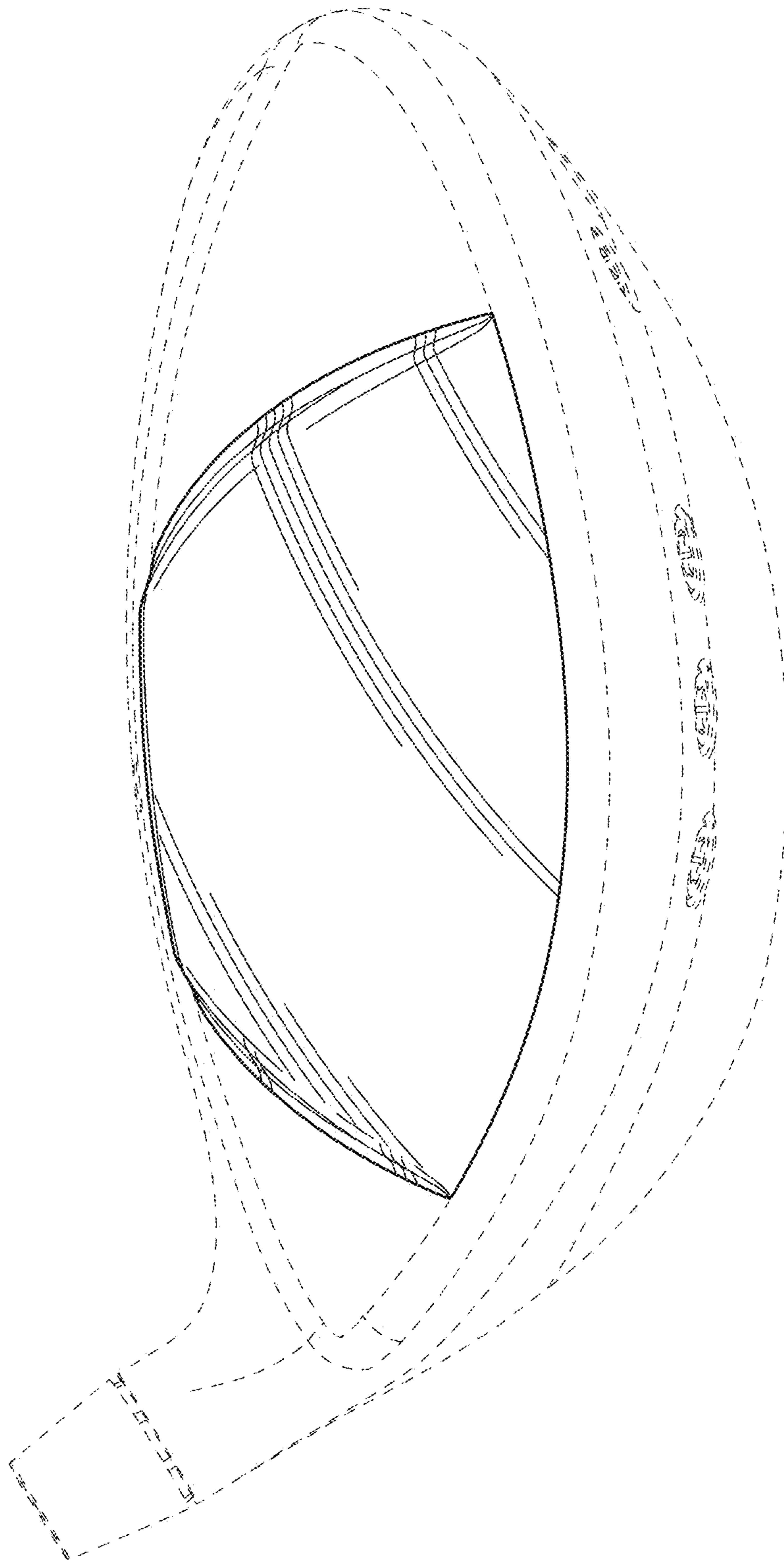

FIG. 4

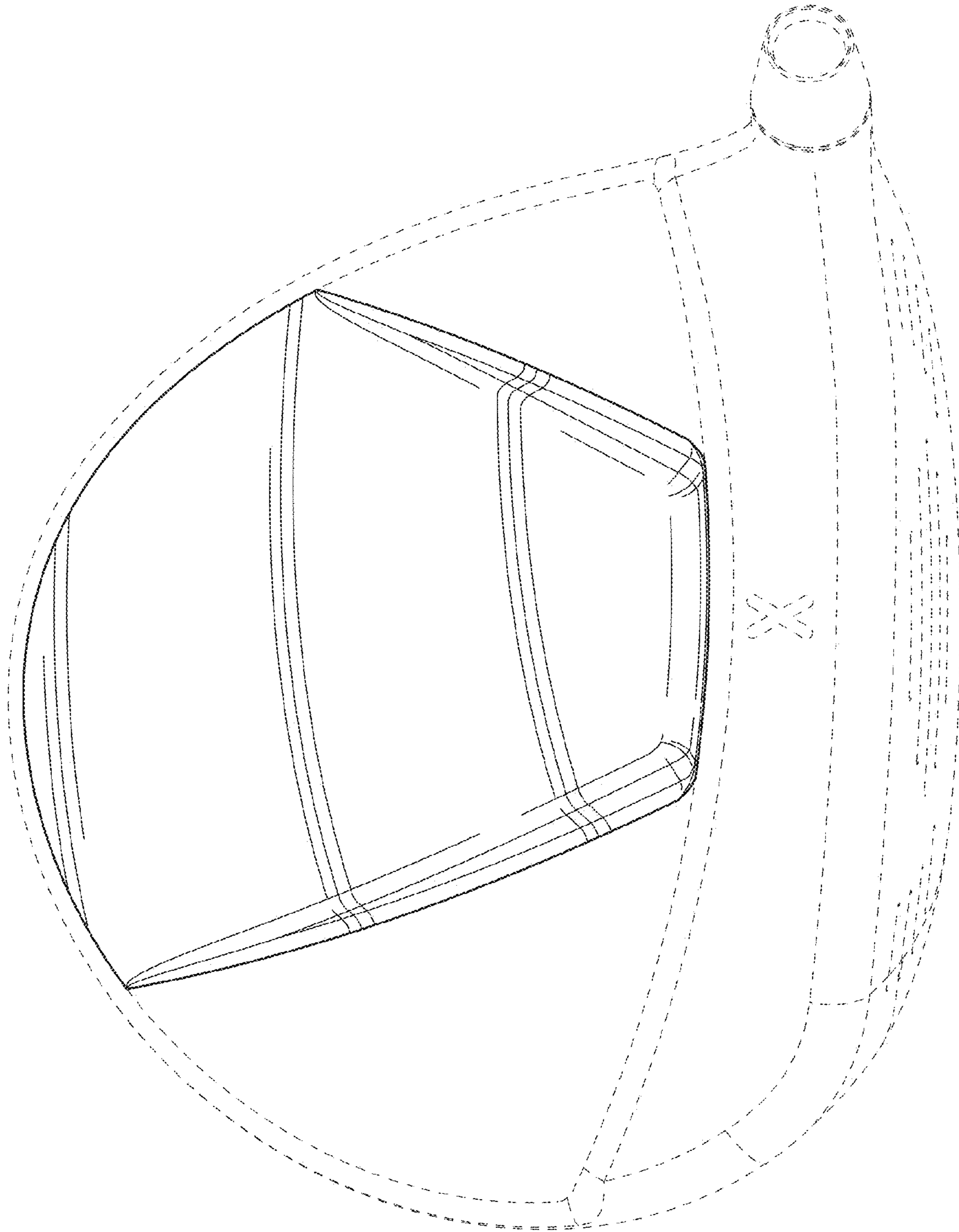

FIG. 5

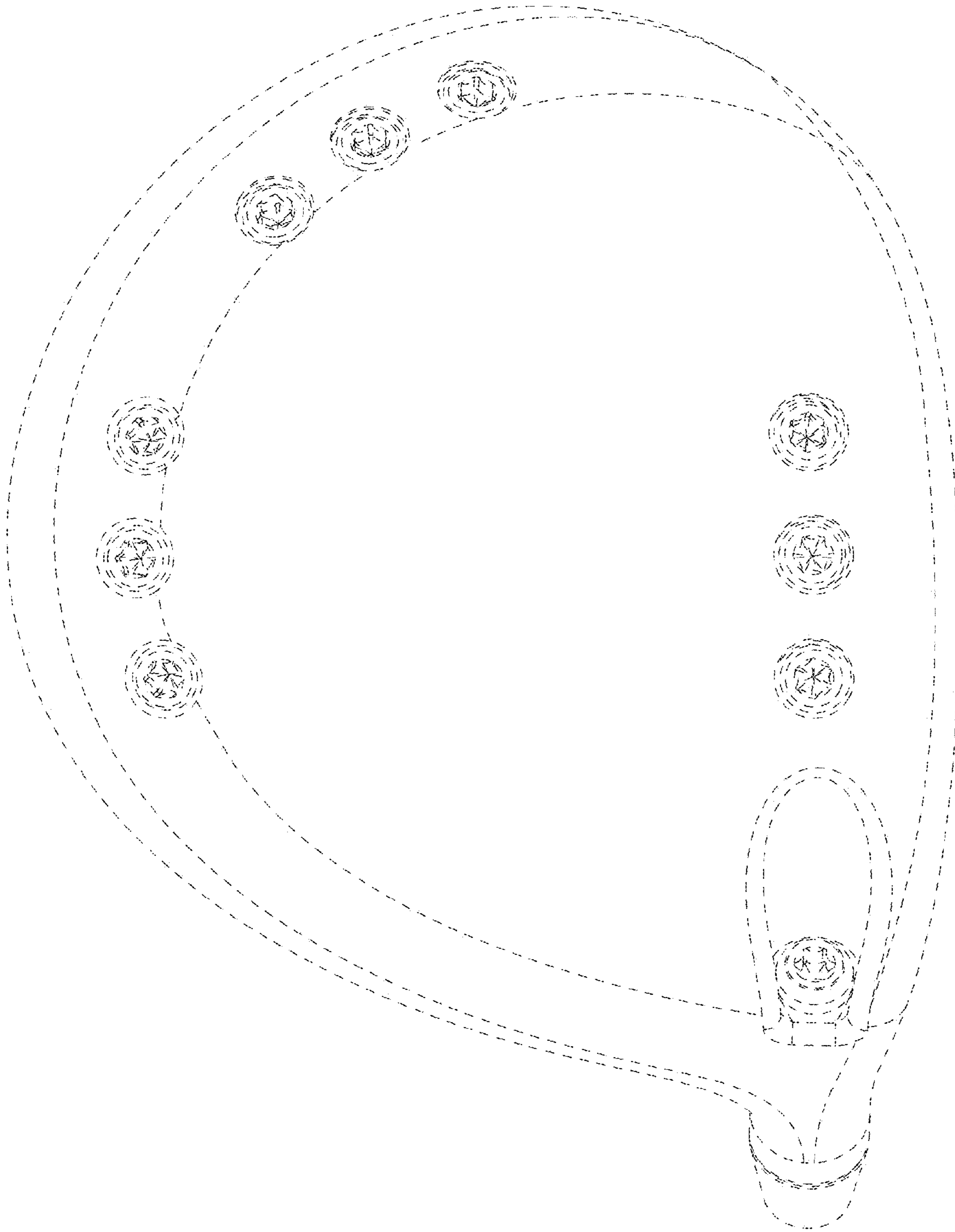

FIG. 6

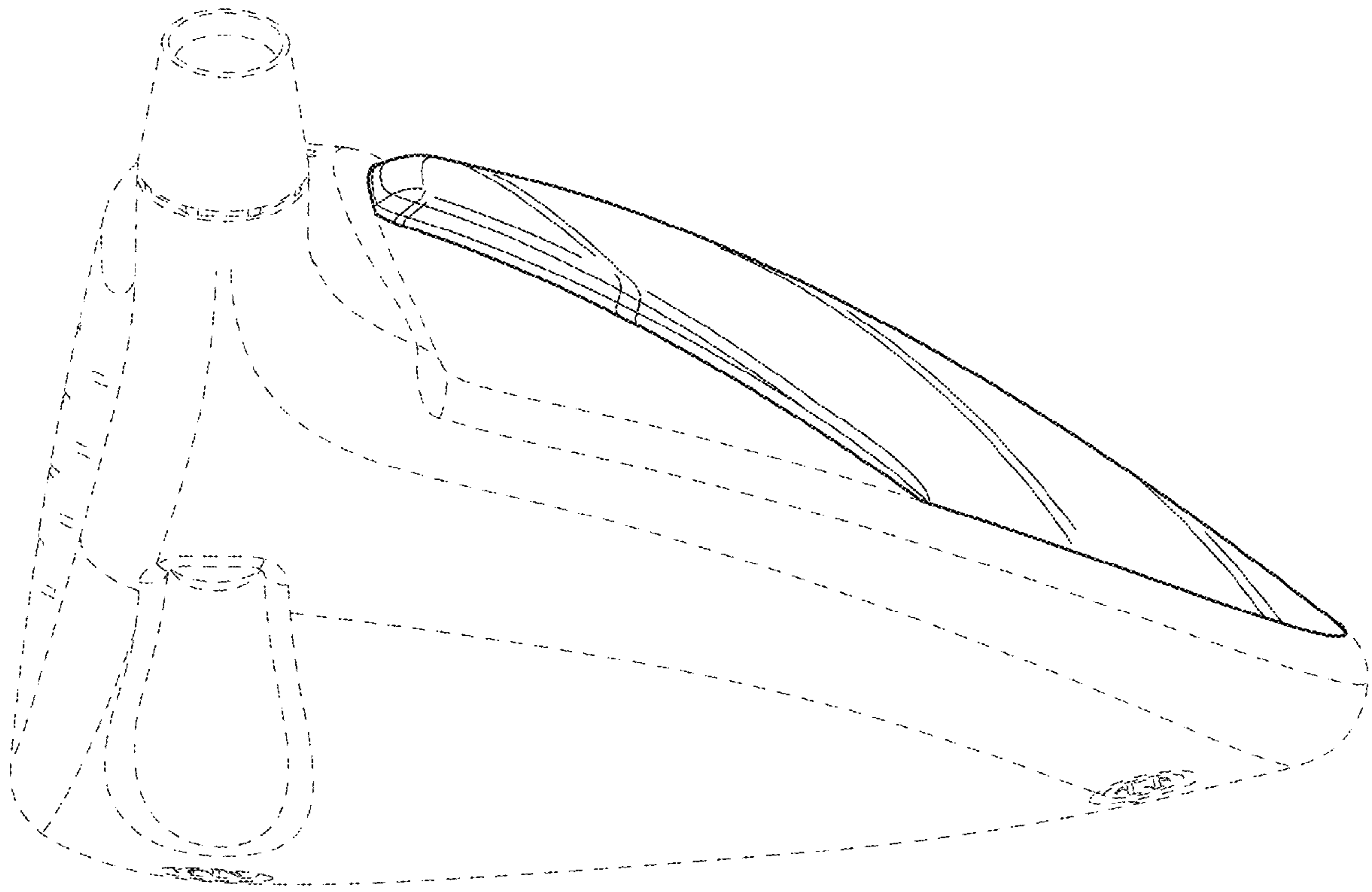

FIG. 7

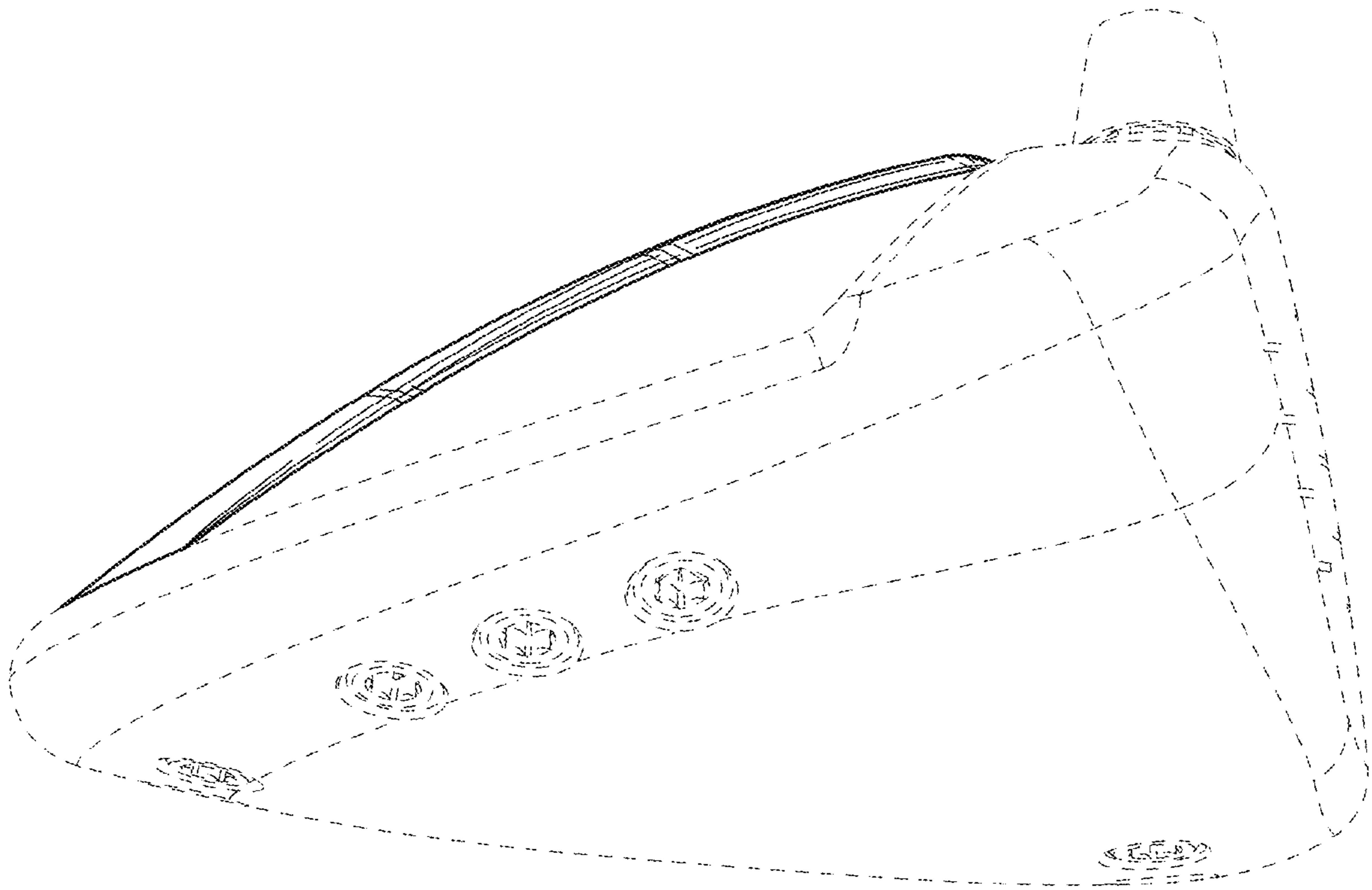

FIG. 8