



US00D929978S

(12) **United States Design Patent** (10) **Patent No.:** **US D929,978 S**
Hwang et al. (45) **Date of Patent:** **** Sep. 7, 2021**

(54) **CASE FOR ELECTRONIC COMMUNICATIONS DEVICE**

(71) Applicant: **Samsung Electronics Co., Ltd.**, Suwon-si (KR)

(72) Inventors: **Ji Su Hwang**, Suwon-si (KR); **Min Ah Koh**, Suwon-si (KR)

(73) Assignee: **Samsung Electronics Co., Ltd.**, Suwon-si (KR)

(**) Term: **15 Years**

(21) Appl. No.: **29/691,444**

(22) Filed: **May 16, 2019**

(30) **Foreign Application Priority Data**

Dec. 21, 2018 (KR) 30-2018-0060842

(51) **LOC (13) Cl.** **14-03**

(52) **U.S. Cl.**
USPC **D14/250**

(58) **Field of Classification Search**
USPC D14/203.3–203.7, 439, 251–253, 447, D14/217, 240, 238.1, 250, 440, 248; D13/107–108, 103, 119; D3/201, 218, D3/247, 249, 269, 273, 301, 303
CPC . H04B 1/3888; A45C 13/02; A45C 2011/002; A45C 1/06; A45C 11/00; A45F 2005/026; A45F 2200/0525; A45F 2200/0516; H04M 1/0283; H04M 1/0202
See application file for complete search history.

(56) **References Cited**

U.S. PATENT DOCUMENTS

D685,801 S * 7/2013 Canizares D14/440
D694,741 S * 12/2013 Kim D14/250
D702,673 S * 4/2014 Murchison D14/250
D710,838 S * 8/2014 Song D14/250

D712,393 S * 9/2014 Kim D14/250
D714,053 S * 9/2014 Yoo D3/269
D733,111 S * 6/2015 Kim D14/250
D744,491 S * 12/2015 Lee D14/440
D748,097 S * 1/2016 Feng D14/440
D755,172 S * 5/2016 Lee D14/250
D765,637 S * 9/2016 Lay D14/250
D765,639 S * 9/2016 Lay D14/250
D777,159 S * 1/2017 Lee D14/250

(Continued)

Primary Examiner — Carla J Wright
(74) *Attorney, Agent, or Firm* — NSIP Law

(57) **CLAIM**

We claim the ornamental design for a case for electronic communications device, as shown and described.

DESCRIPTION

FIG. 1 is a front, right-side, and top perspective view of a case for electronic communications device showing our new design;
FIG. 2 is a front view thereof;
FIG. 3 is a rear view thereof;
FIG. 4 is a left-side view thereof;
FIG. 5 is a right-side view thereof;
FIG. 6 is a top view thereof;
FIG. 7 is a bottom view thereof;
FIG. 8 is a rear, left-side, and bottom perspective view thereof;
FIG. 9 is an enlarged view of the encircled portion in FIG. 5; and,
FIG. 10 is an enlarged view of the encircled portion in FIG. 7.

The evenly-dashed broken lines in the figures depict portions of the case for electronic communications device which form no part of the claimed design.
The dot-dash broken lines encircling portions of the claimed design that are illustrated in enlargements form no part of the claimed design.

1 Claim, 10 Drawing Sheets

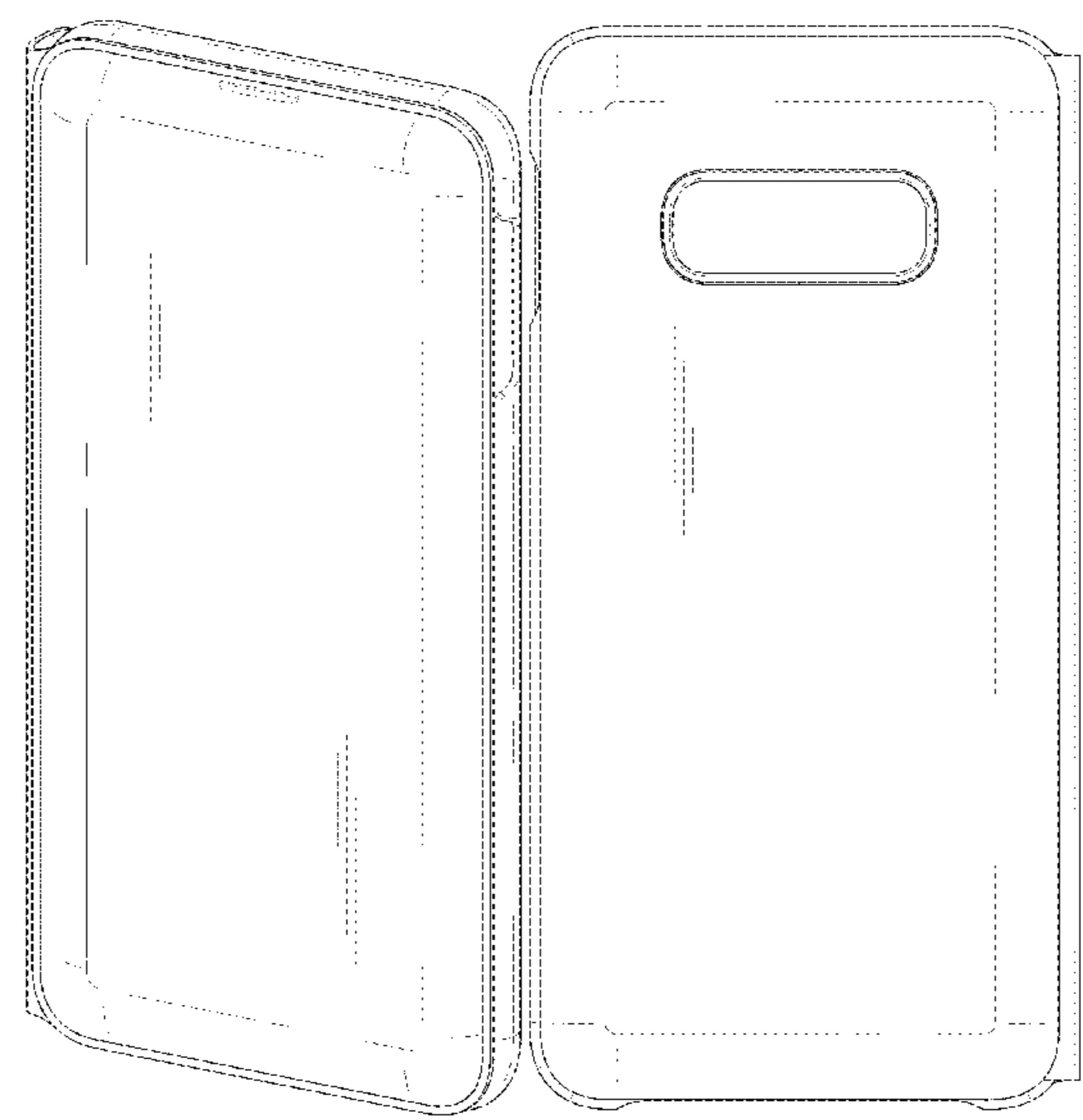

(56)

References Cited

U.S. PATENT DOCUMENTS

D777,421 S * 1/2017 Grote D3/218
D794,627 S * 8/2017 Roberts D14/250
D800,732 S * 10/2017 Dang D14/440
D819,007 S * 5/2018 Kim D14/250
D848,409 S * 5/2019 Feng D14/250
D859,389 S * 9/2019 Kim D14/250
D911,322 S * 2/2021 Jeong D14/250
2012/0085679 A1* 4/2012 Kim A45C 3/001
206/736
2018/0191892 A1* 7/2018 Kim H04M 1/185

* cited by examiner

FIG. 1

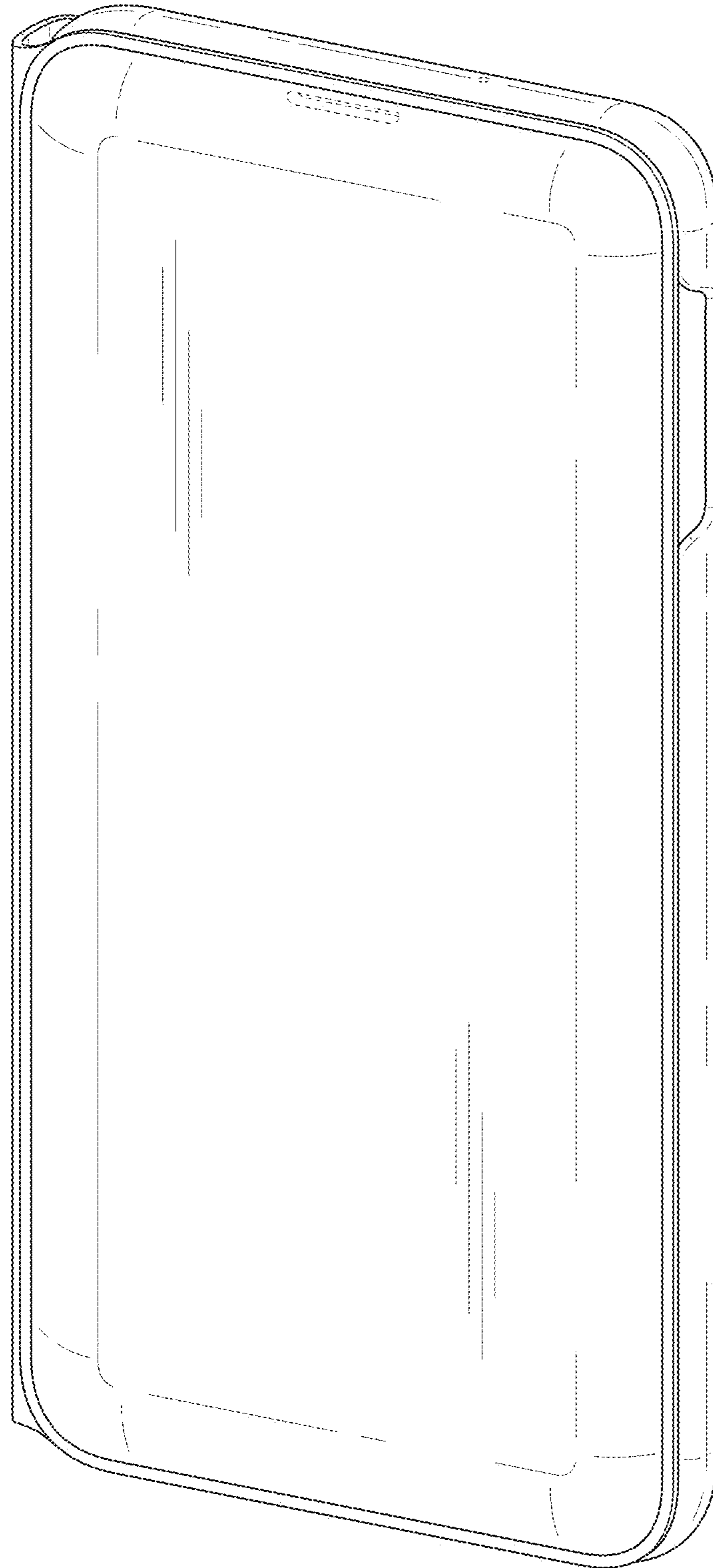

FIG. 2

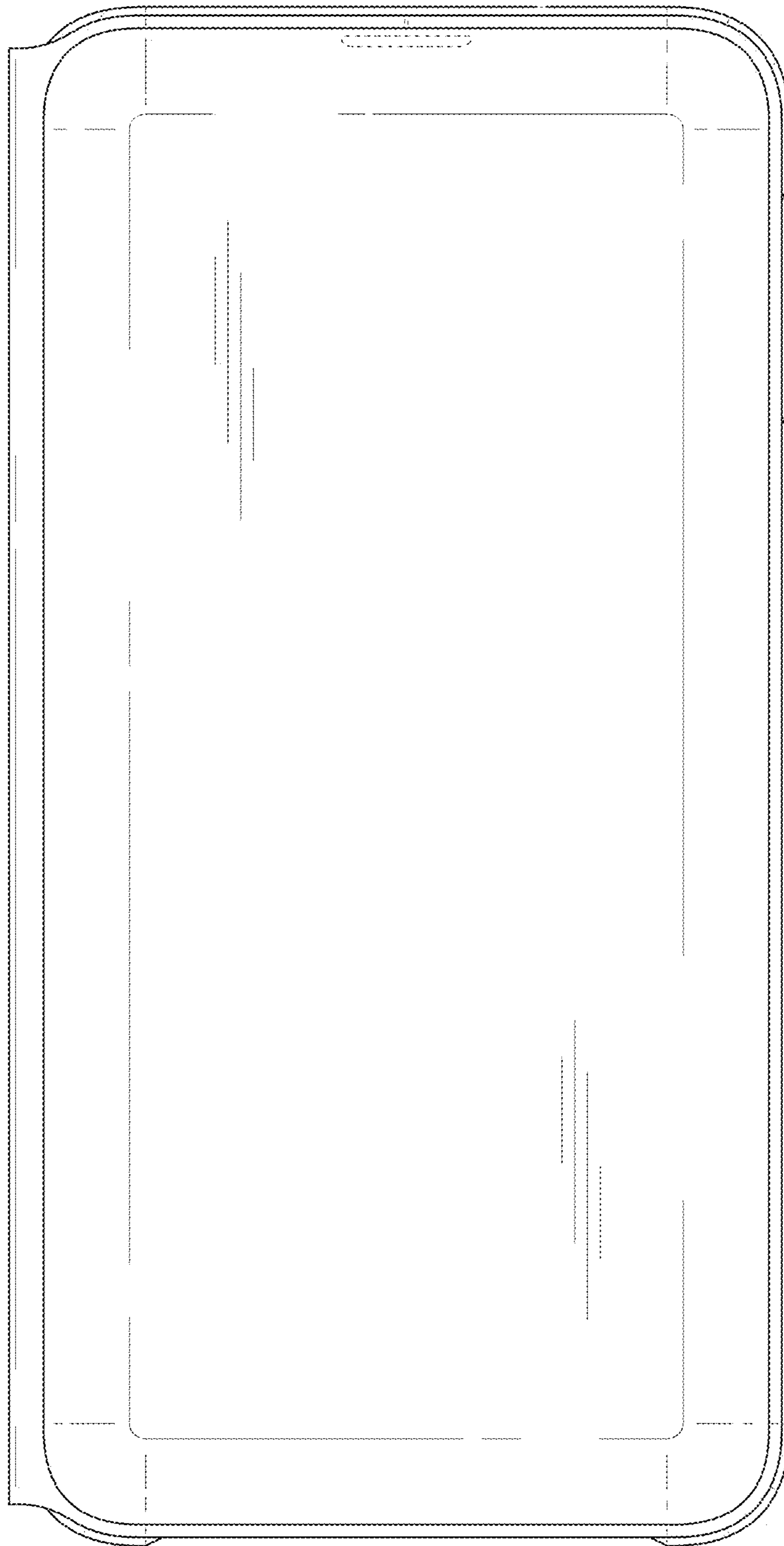

FIG. 3

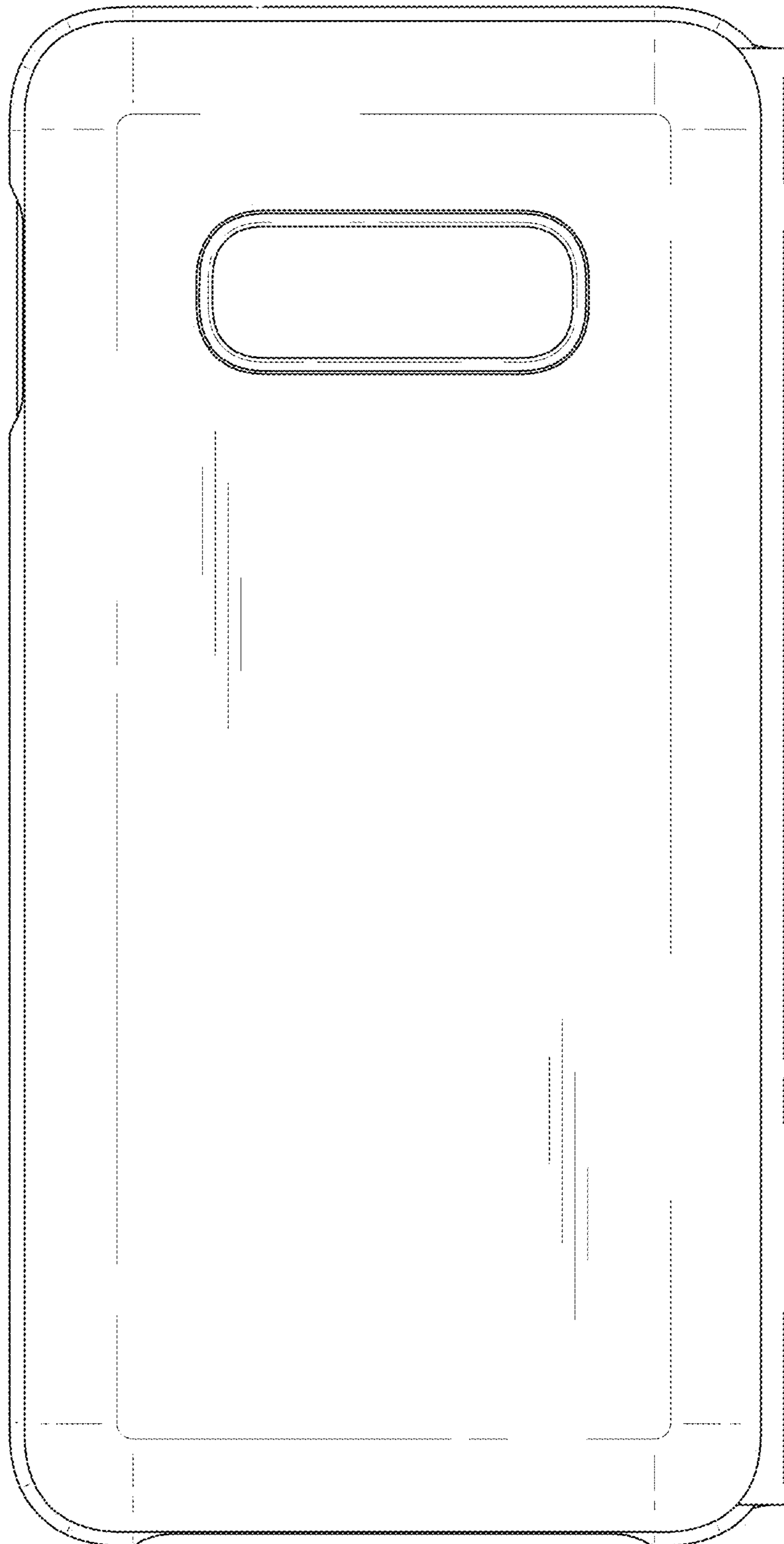

FIG. 4

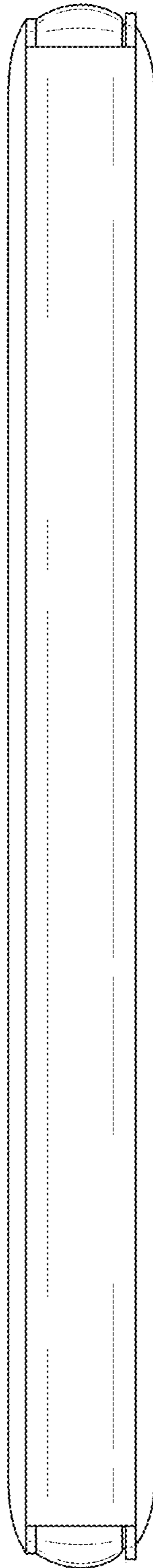

FIG. 5

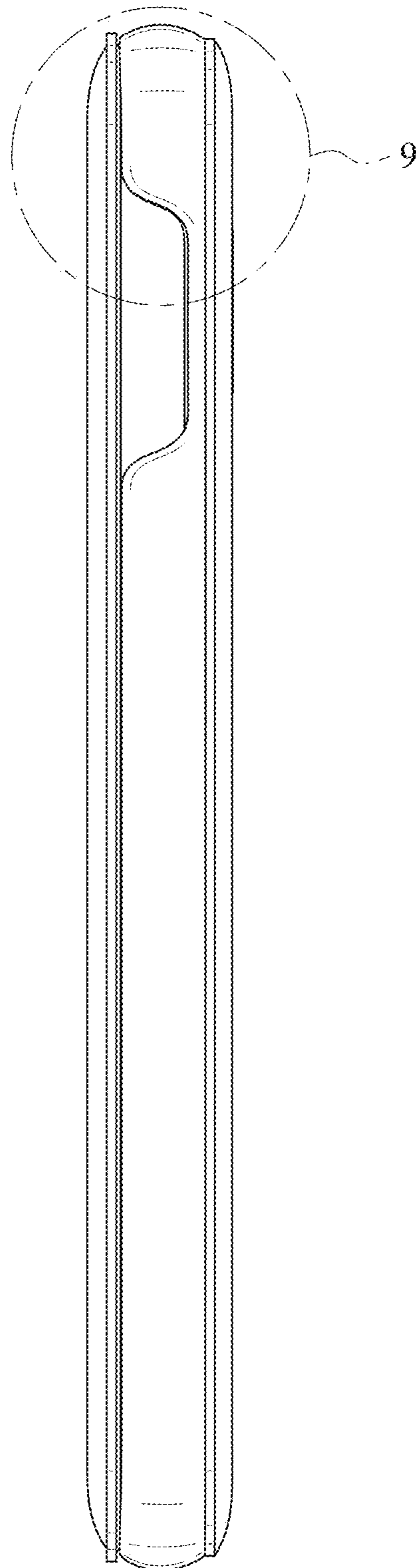

FIG. 6

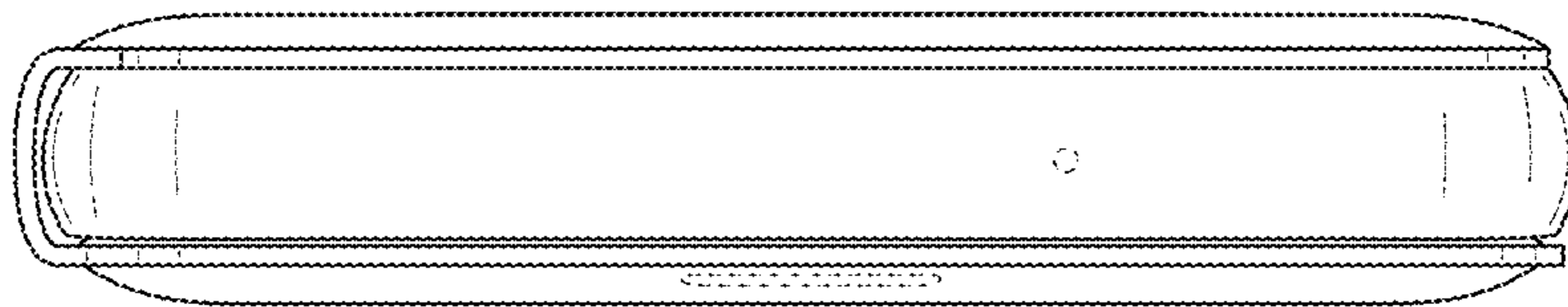

FIG. 7

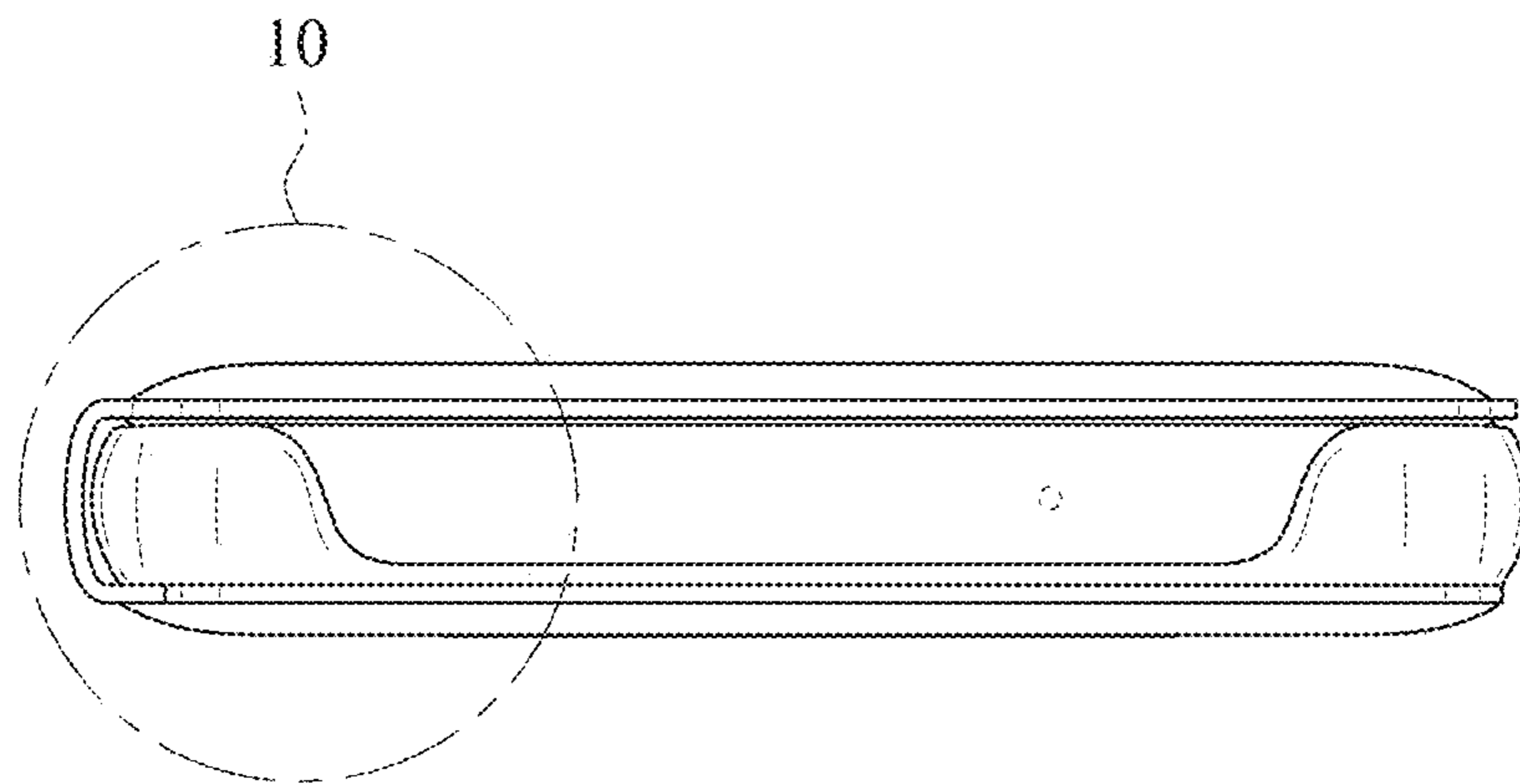

FIG. 8

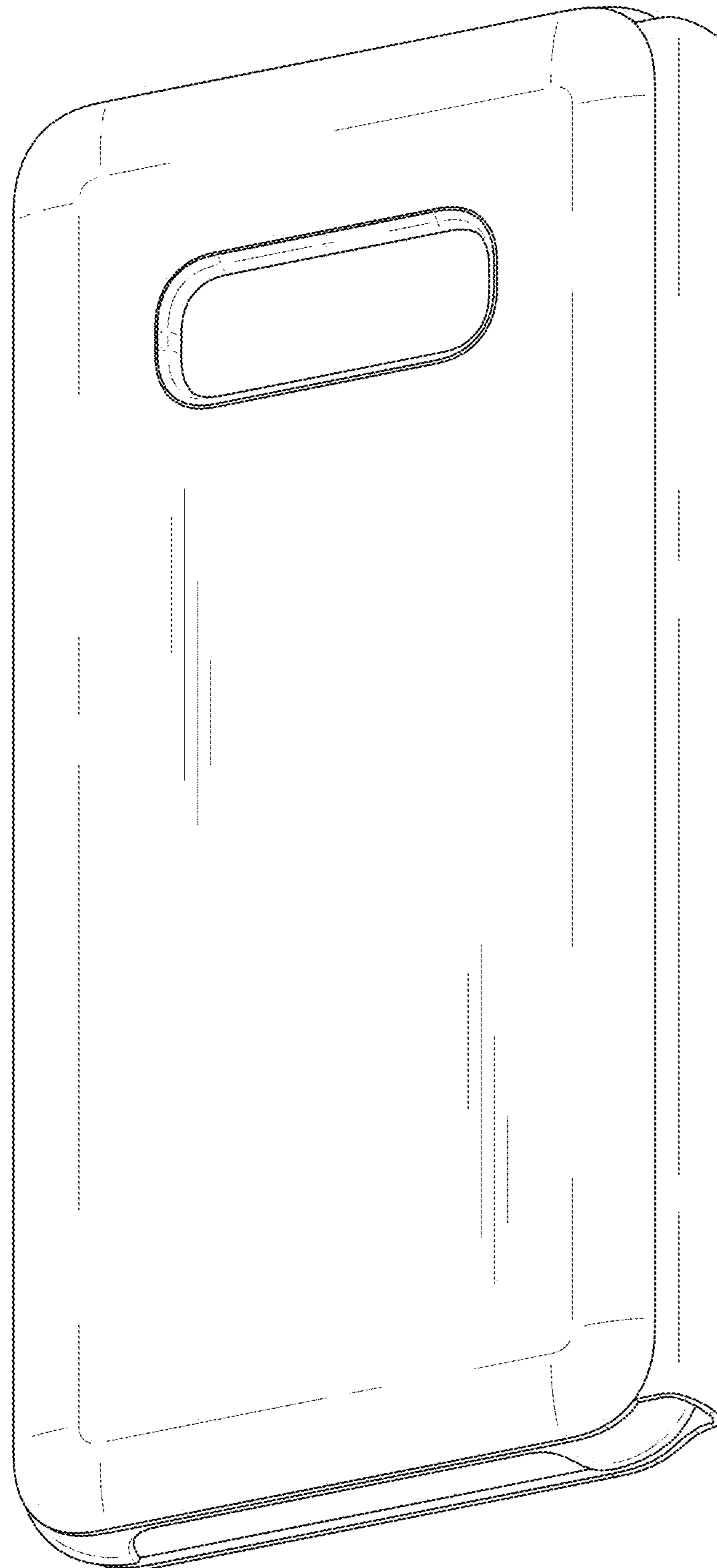

FIG. 9

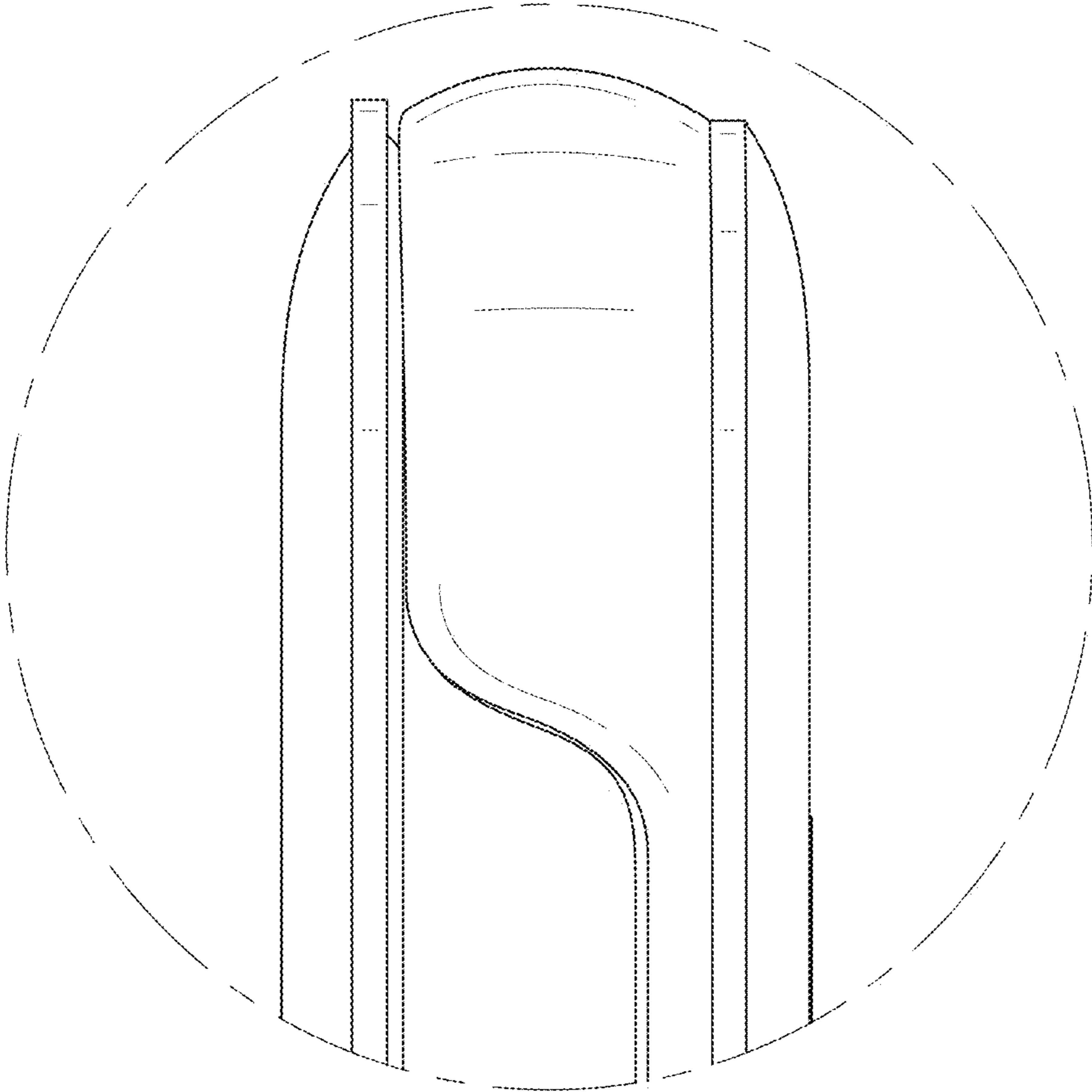

FIG. 10

