



US00D929977S

(12) **United States Design Patent** (10) **Patent No.:** **US D929,977 S**
Park et al. (45) **Date of Patent:** **** Sep. 7, 2021**

(54) **MOBILE PHONE**

(71) Applicant: **Samsung Electronics Co., Ltd.**,
Suwon-si (KR)
(72) Inventors: **Hyoungshin Park**, Seoul (KR);
Dongkyun Kim, Seoul (KR); **Yunjin Kim**, Seoul (KR); **Seonkeun Park**,
Seoul (KR); **Seungho Jang**,
Seongnam-si (KR)

(73) Assignee: **Samsung Electronics Co., Ltd.**,
Suwon-si (KR)

(**) Term: **15 Years**

(21) Appl. No.: **29/707,409**

(22) Filed: **Sep. 27, 2019**

Related U.S. Application Data

(62) Division of application No. 29/656,388, filed on Jul.
12, 2018.

Foreign Application Priority Data

Jan. 12, 2018 (KR) 30-2018-0002202

(51) **LOC (13) Cl.** **14-03**

(52) **U.S. Cl.**
USPC **D14/248**

(58) **Field of Classification Search**
USPC .. D14/138 G, 248, 341, 345, 439, 432, 371,
D14/374, 138 R, 138 AA, 138 AB,
D14/138 AC, 138 AD, 138 C
CPC H04M 1/0202; H04M 1/0235; H04M
1/0237; H04M 1/0239; H04M 1/0266;
H04M 1/0268; H04M 1/027; H04M
1/0295; H04M 1/02; H04M 1/0279;
H04M 1/0283

See application file for complete search history.

(56) **References Cited**

U.S. PATENT DOCUMENTS

D585,411 S 1/2009 Eaton
D622,248 S 8/2010 Kwon et al.
D645,011 S 9/2011 Min

(Continued)

OTHER PUBLICATIONS

Samsung Galaxy S10 5G, Feb. 2019, http://www.gsmarena.com, www.gsmarena.com/samsung_Galaxy_S10.

(Continued)

Primary Examiner — Bridget L Eland

(74) *Attorney, Agent, or Firm* — NSIP Law

(57) **CLAIM**

We claim the ornamental design for a mobile phone, as shown and described.

DESCRIPTION

FIG. 1 is a front perspective view of a mobile phone showing our new design;

FIG. 2 is a front view thereof;

FIG. 3 is a rear view thereof;

FIG. 4 is a left-side view thereof;

FIG. 5 is a right-side view thereof;

FIG. 6 is a top view thereof;

FIG. 7 is a bottom view thereof;

FIG. 8 is a rear perspective view thereof; and,

FIG. 9 is an enlarged view of the encircled portion in FIG. 2.

The evenly-spaced broken lines in the figures depict portions of the mobile phone that form no part of the claimed design. The dot-dash broken lines in the figures represent a boundary of the claimed design and form no part thereof.

(Continued)

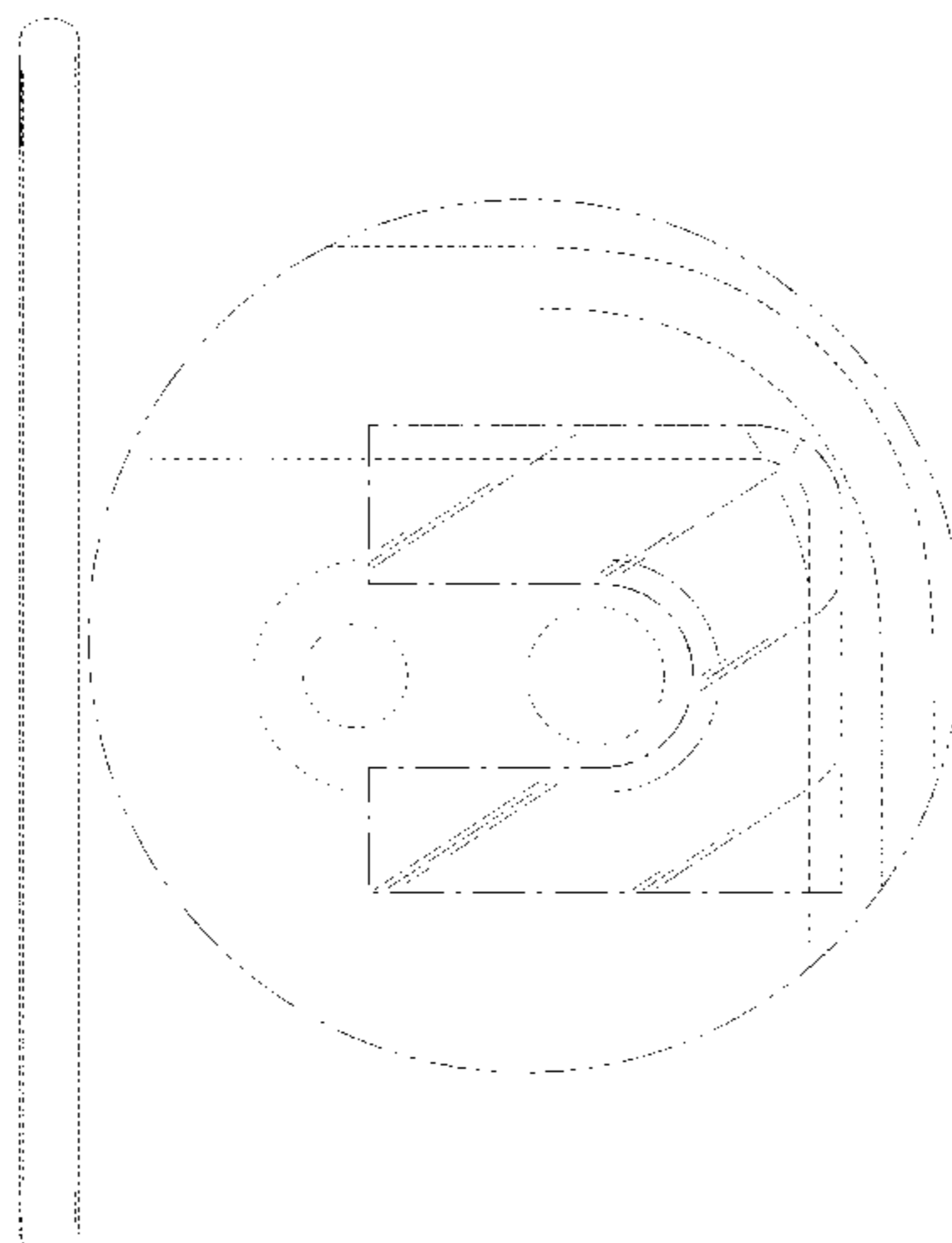

The dot-dot-dash broken lines in FIGS. 2 and 9 encircle portions of the claimed design that are illustrated in an enlargement and form no part of the claimed design.

1 Claim, 7 Drawing Sheets

(56)

References Cited

U.S. PATENT DOCUMENTS

D646,251 S	10/2011	Park et al.	
D648,299 S	11/2011	Kim	
D648,300 S	11/2011	Park et al.	
D665,766 S	8/2012	Eguchi	
D694,214 S	11/2013	Kim et al.	
D696,221 S	12/2013	Lee et al.	
D700,161 S	2/2014	Yoshihara	
D700,589 S	3/2014	Yoo et al.	
D703,174 S	4/2014	Suk	
D711,341 S	8/2014	Shin et al.	
D720,318 S	12/2014	Kim et al.	
D722,038 S	2/2015	Cheng et al.	
D738,843 S	9/2015	Yoon et al.	
D765,068 S	8/2016	Min et al.	
D777,699 S	1/2017	Yuan et al.	
D784,281 S	4/2017	Ryu et al.	
D791,096 S	7/2017	Hu	
D797,726 S	9/2017	Lee et al.	
D800,681 S	10/2017	Kim et al.	
D800,710 S	* 10/2017	Ryu	D14/248
D817,297 S	5/2018	Lee	
D845,287 S	4/2019	Lee et al.	
D846,539 S	4/2019	Choe et al.	
D847,777 S	5/2019	Choi et al.	
D859,382 S	* 9/2019	Yi	D14/248
D859,383 S	* 9/2019	Yi	D14/248

D859,384 S	* 9/2019	Kim	D14/248
D864,934 S	* 10/2019	Park	D14/248
D865,732 S	* 11/2019	Park	D14/248
D865,733 S	* 11/2019	Park	D14/248
D865,735 S	* 11/2019	Park	D14/248
D865,737 S	* 11/2019	Park	D14/248
D865,738 S	* 11/2019	Park	D14/248
D866,540 S	* 11/2019	Park	D14/248
D866,541 S	* 11/2019	Park	D14/248
D866,542 S	* 11/2019	Park	D14/248
D867,351 S	* 11/2019	Park	D14/248
D868,049 S	* 11/2019	Kim	D14/248
D868,763 S	* 12/2019	Kim	D14/248
D870,088 S	* 12/2019	Kim	D14/248
D890,737 S	* 7/2020	Park	D14/248
D892,780 S	* 8/2020	Park	D14/248
D892,781 S	* 8/2020	Park	D14/248
D894,163 S	* 8/2020	Kim	D14/248
D894,859 S	* 9/2020	Park	D14/138 G
D904,368 S	* 12/2020	Seo	D14/248
D915,368 S	* 4/2021	Park	D14/248
D916,065 S	* 4/2021	Park	D14/248
D916,674 S	* 4/2021	Seo	D14/138 G

OTHER PUBLICATIONS

Samsung Galaxy S10+, Feb. 2019; <http://www.gsmarena.com>, www.gsmarena.com/samsung_Galaxy_S10+.
 Samsung Galaxy S10e, Feb. 2019; <http://www.gsmarena.com>, www.gsmarena.com/samsung_Galaxy_S10e.
 Nokia X71, Apr. 2019, <http://www.gsmarena.com>, www.gsmarena.com/samsung_Nokia_x71.
 Motorola One Vision, May 2019, <http://www.gsmarena.com>, www.gsmarena.com/Motorola_One_Vision.
 Honor 20, May 2019, <http://www.gsmarena.com>; www.gsmarena.com/samsung_Honor_20.

* cited by examiner

FIG. 1

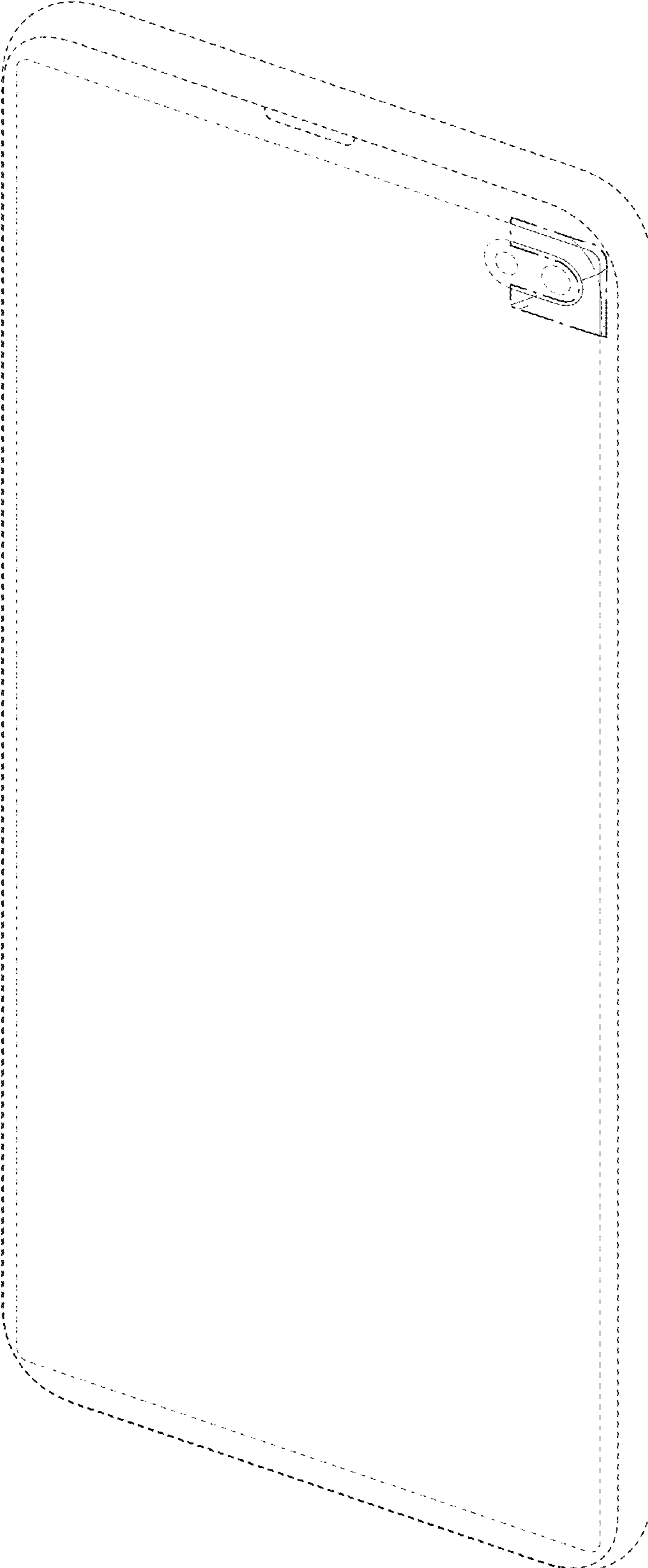

FIG. 2

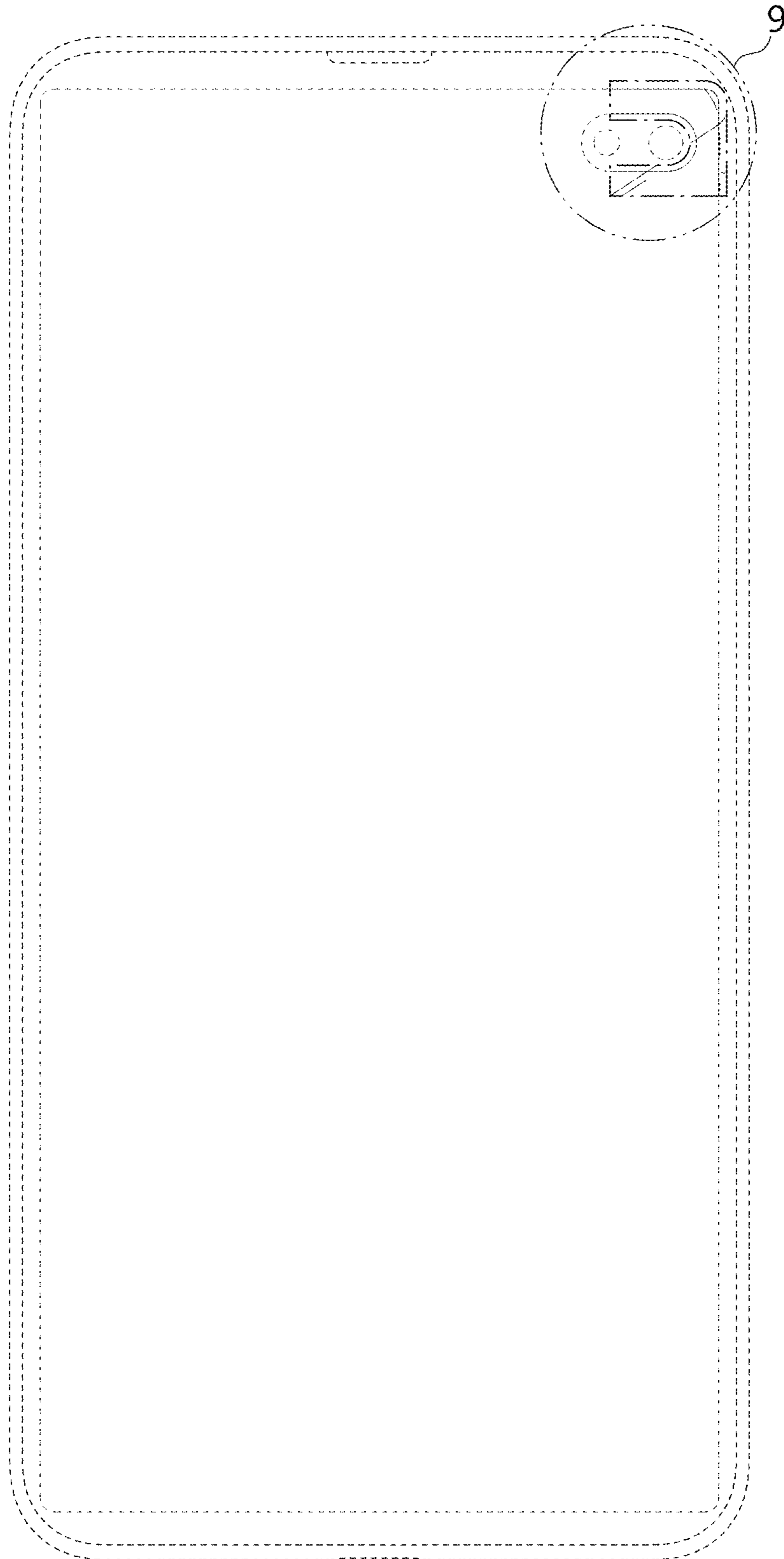

FIG. 3

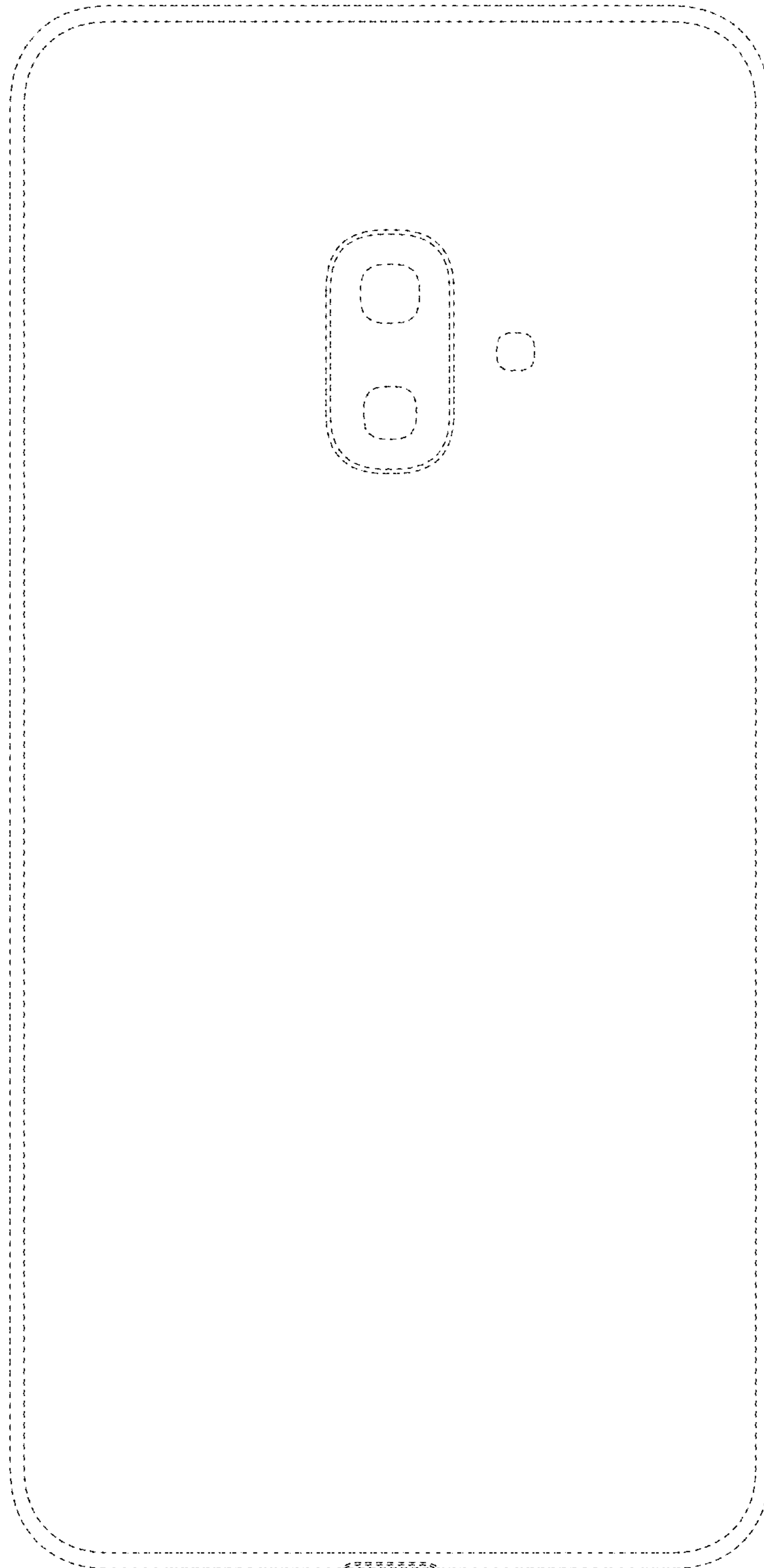

FIG. 4

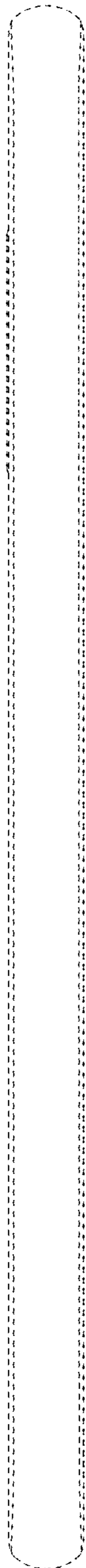

FIG. 5

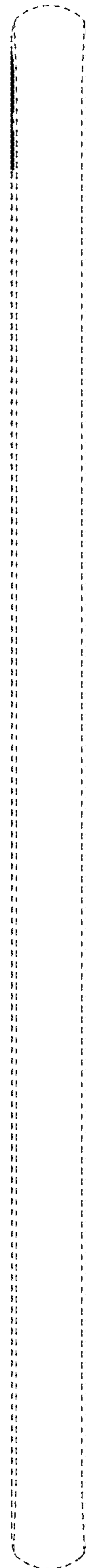

FIG. 6



FIG. 7

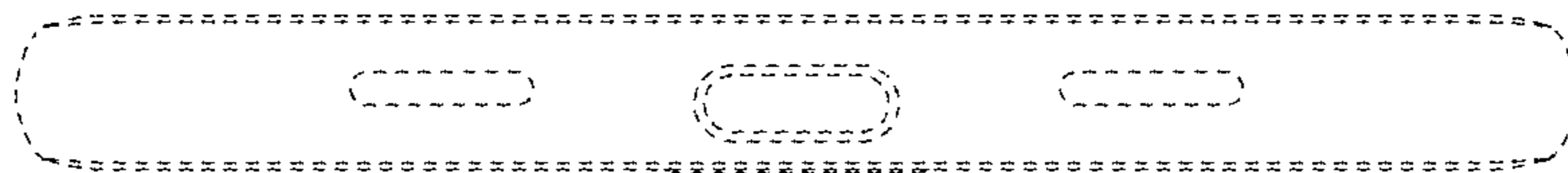

FIG. 8

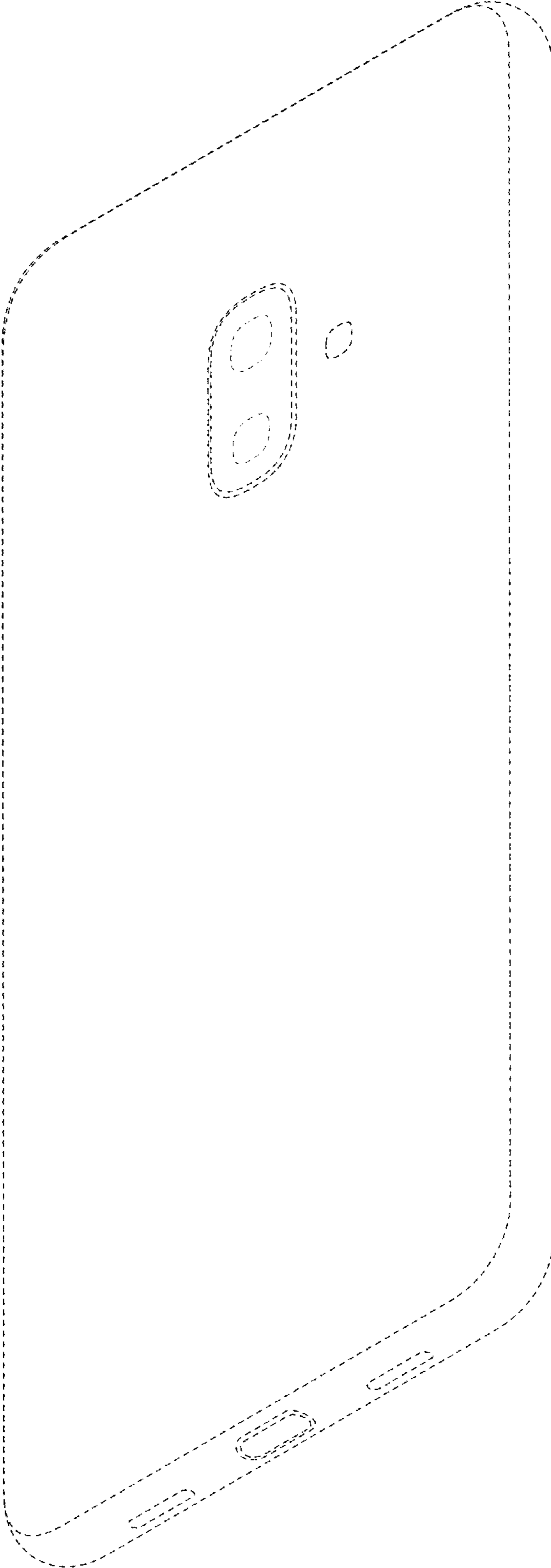

FIG. 9

