



US00D929860S

(12) **United States Design Patent** (10) **Patent No.:** **US D929,860 S**
Caicedo et al. (45) **Date of Patent:** **** Sep. 7, 2021**

(54) **PACKAGE**

(71) Applicant: **BMIC LLC**, Dallas, TX (US)

(72) Inventors: **Carlos Caicedo**, Dallas, TX (US); **Natalie Cruz**, Dallas, TX (US); **Carol Monza**, Dallas, TX (US); **Michael Comiskey**, Dallas, TX (US); **David Shin**, Dallas, TX (US); **Don Miller**, Dallas, TX (US); **Carolyn Eckert**, Dallas, TX (US)

(73) Assignee: **BMIC LLC**, Dallas, TX (US)

(**) Term: **15 Years**

(21) Appl. No.: **29/774,910**

(22) Filed: **Mar. 19, 2021**

Related U.S. Application Data

(62) Division of application No. 29/757,747, filed on Nov. 9, 2020.

(51) **LOC (13) Cl.** **09-03**

(52) **U.S. Cl.**
USPC **D9/432**

(58) **Field of Classification Search**
USPC D9/414, 420, 423, 430-434, 435, 438, D9/600, 667; D24/197

(Continued)

(56) **References Cited**

U.S. PATENT DOCUMENTS

D329,199 S * 9/1992 Corso D9/418
D391,481 S * 3/1998 Oxley D9/432

(Continued)

OTHER PUBLICATIONS

29774910_ForeignRefs_Orbit. (Design © Questel) orbit.com. [Online PDF compilation of references selected by examiner] 11 pgs.

Retrieved Jun. 1, 2021 from URL: <https://www.orbit.com/export/QPTUJ190/pdf2/73dd1c95-80c9-4c80-8041-8b2ff09b21f4-212207.pdf>.*

Primary Examiner — Vy N Koenig
(74) *Attorney, Agent, or Firm* — Greenberg Traurig, LLP

(57) **CLAIM**

The ornamental design for a package, as shown and described.

DESCRIPTION

FIG. 1 is a front perspective view of a first embodiment of a package.

FIG. 2 is a front view of the first embodiment of the package shown in FIG. 1.

FIG. 3 is a back view of the first embodiment of the package shown in FIG. 1.

FIG. 4 is a right side view of the first embodiment of the package shown in FIG. 1.

FIG. 5 is a left side view of the first embodiment of the package shown in FIG. 1.

FIG. 6 is a top view of the first embodiment of the package shown in FIG. 1.

FIG. 7 is a bottom view of the first embodiment of the package shown in FIG. 1.

FIG. 8 is a front perspective view of a second embodiment of a package.

FIG. 9 is a front view of the second embodiment of the package shown in FIG. 8.

FIG. 10 is a back view of the second embodiment of the package shown in FIG. 8.

FIG. 11 is a right side view of the second embodiment of the package shown in FIG. 8.

FIG. 12 is a left side view of the second embodiment of the package shown in FIG. 8.

FIG. 13 is a top view of the second embodiment of the package shown in FIG. 8; and,

FIG. 14 is a bottom view of the second embodiment of the package shown in FIG. 8.

(Continued)

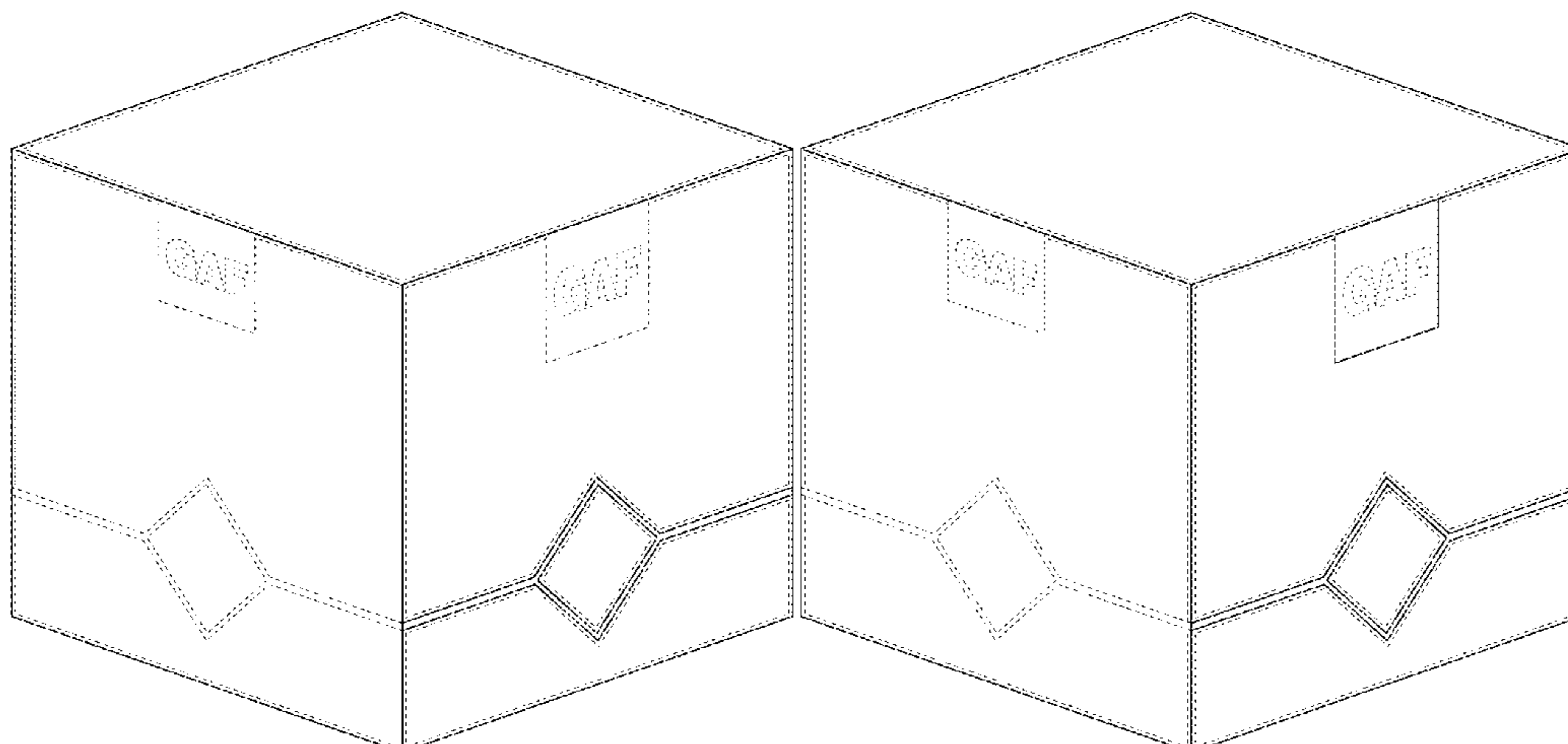

The broken lines in the drawings illustrate unclaimed features forming no part of the claimed design.

1 Claim, 8 Drawing Sheets

(58) Field of Classification Search

CPC B65D 5/00; B65D 5/0015; B65D 5/36;
B65D 5/665; B65D 5/4295

See application file for complete search history.

(56) References Cited

U.S. PATENT DOCUMENTS

D628,063	S	*	11/2010	Kusumi	D9/432
D641,621	S	*	7/2011	Kusumi	D9/432
D668,141	S	*	10/2012	Collins	D9/423
D678,762	S	*	3/2013	Cooper	D9/418
D712,737	S	*	9/2014	Gotur	D9/432
D726,025	S	*	4/2015	Somers	D9/667
D745,388	S	*	12/2015	Taylor	D9/418
D772,061	S	*	11/2016	O'Dowd	D9/432
D774,400	S	*	12/2016	Miyazaki	D9/600
D781,701	S	*	3/2017	Brody	D9/432
D782,905	S	*	4/2017	Borkovetz	D9/418
D783,397	S	*	4/2017	Riffe	D9/434
D838,587	S	*	1/2019	Laliberte	D9/432
D853,839	S	*	7/2019	Baker	D9/432
D877,971	S	*	3/2020	Bowen	D27/101
D881,003	S	*	4/2020	Hendricks	D9/432
D918,716	S	*	5/2021	Caicedo	D9/432
2015/0034507	A1	*	2/2015	Liu	A24F 15/01 206/256

* cited by examiner

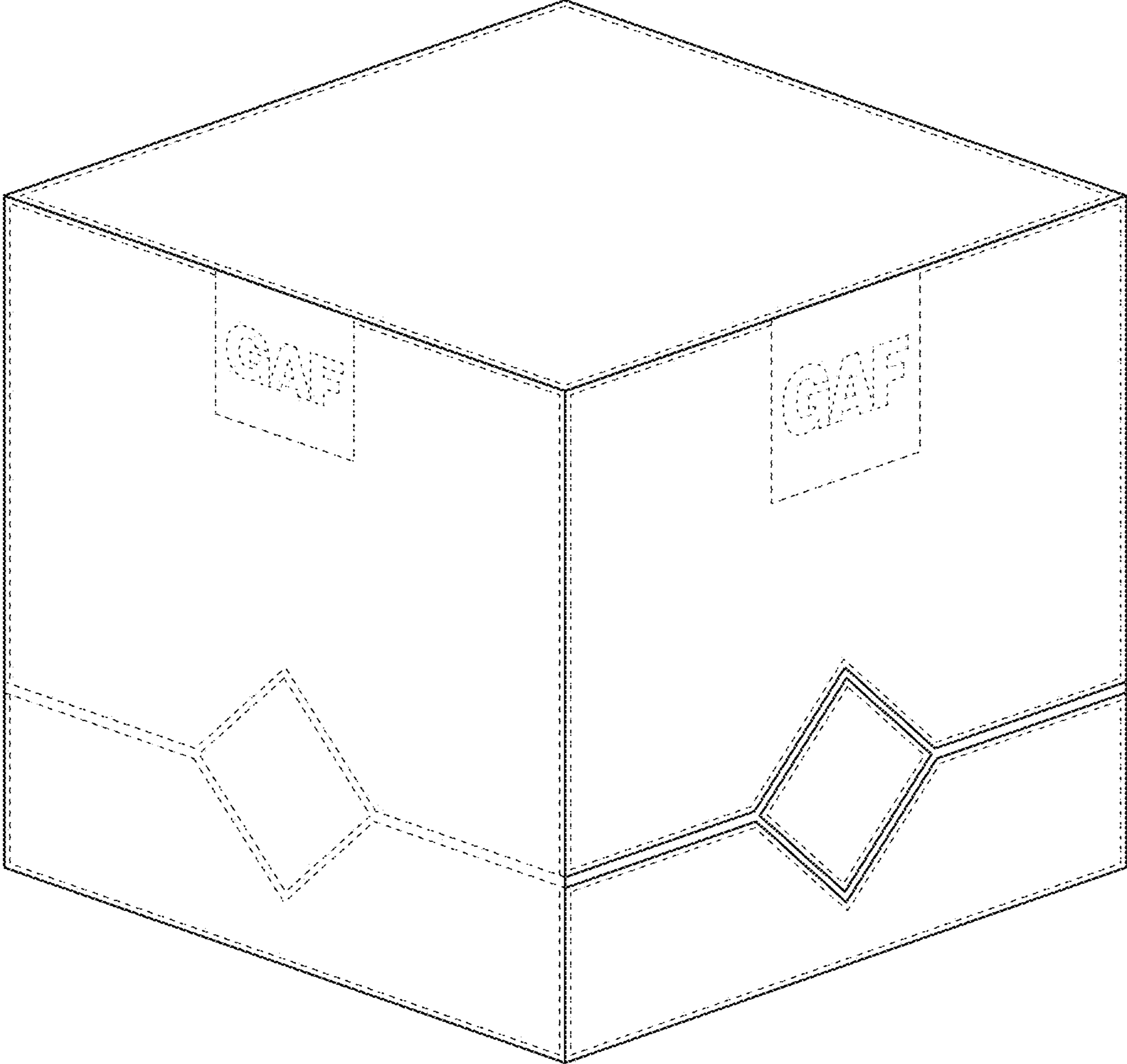

FIG. 1

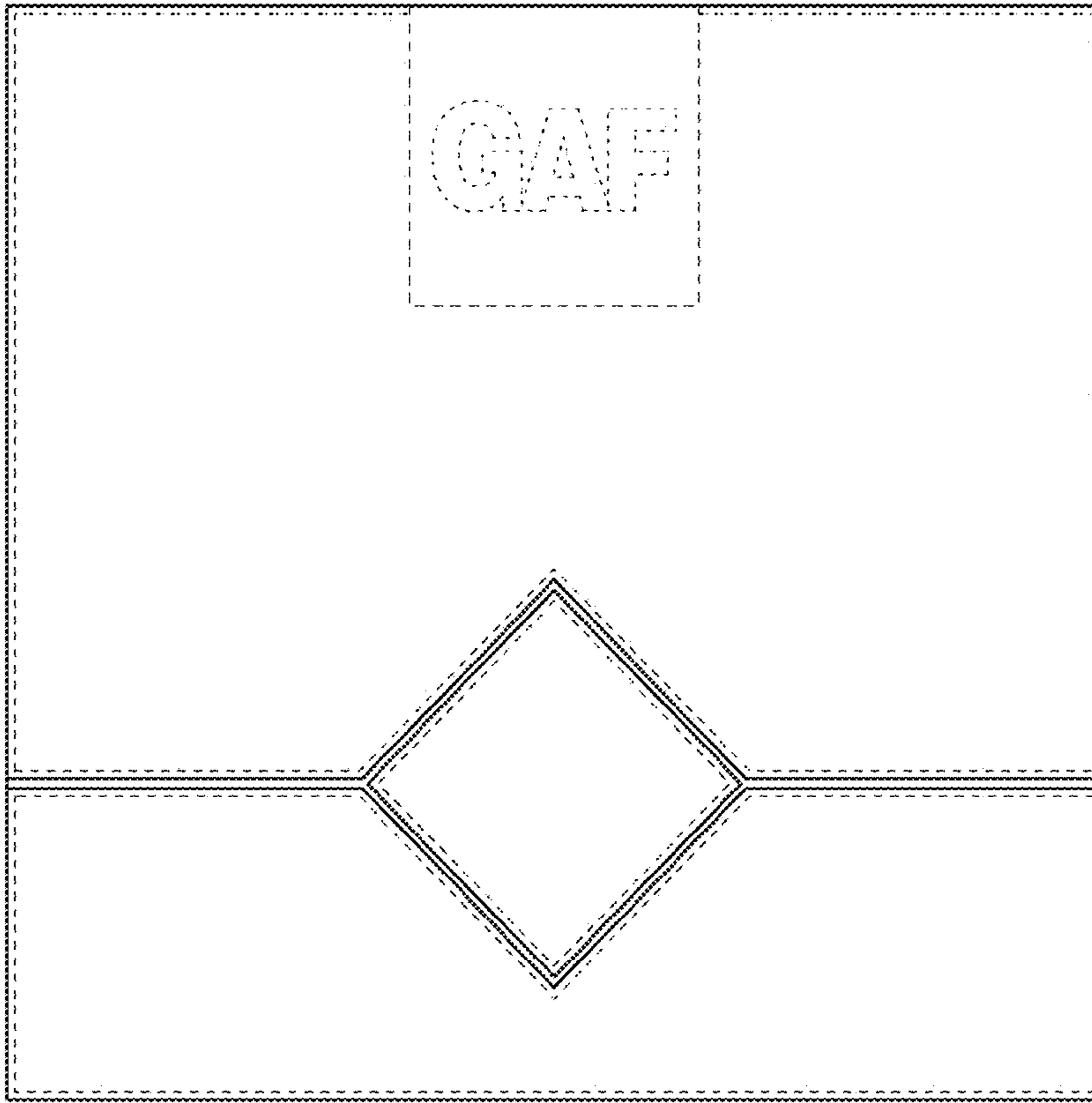

FIG. 2

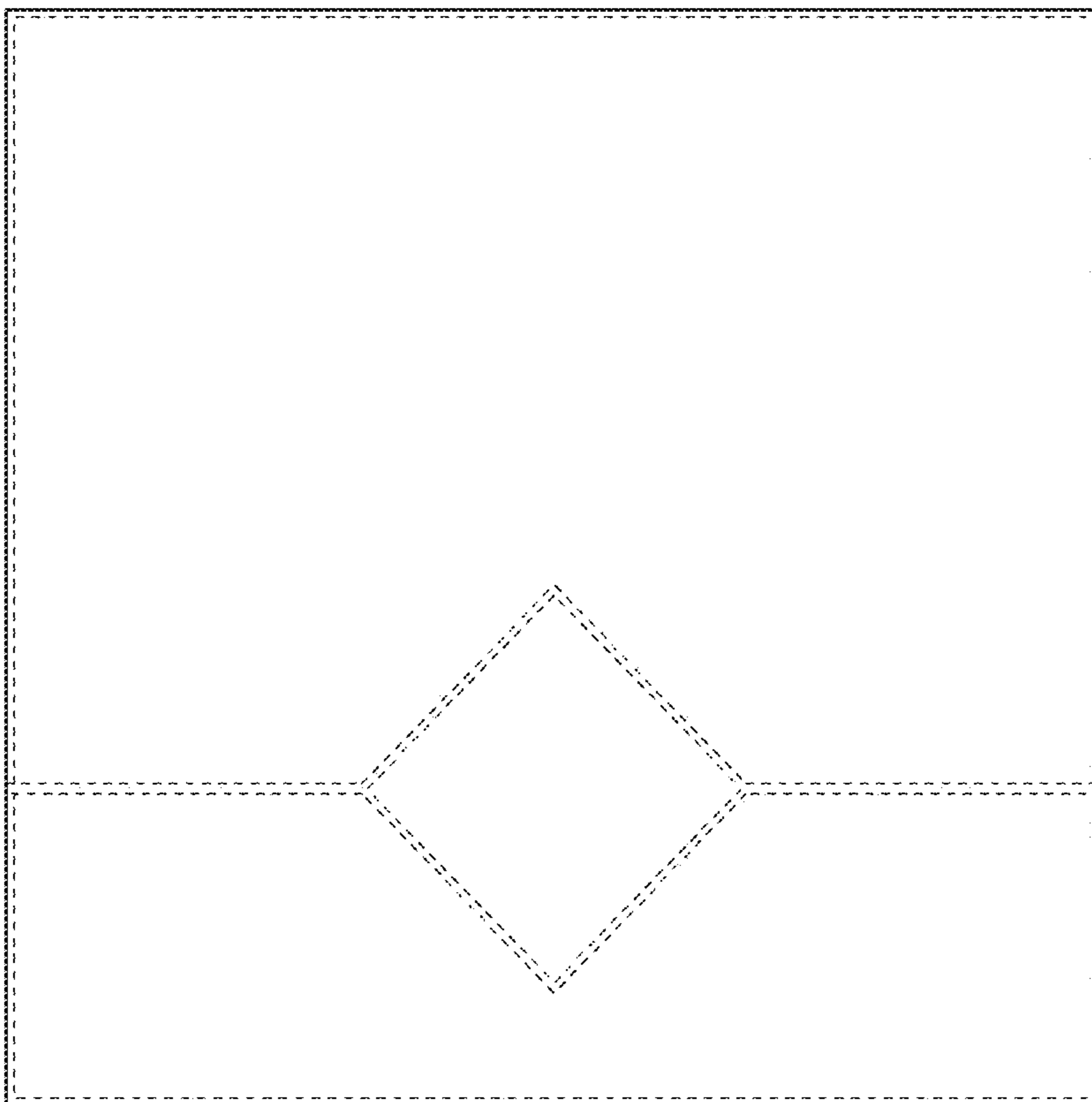

FIG. 3

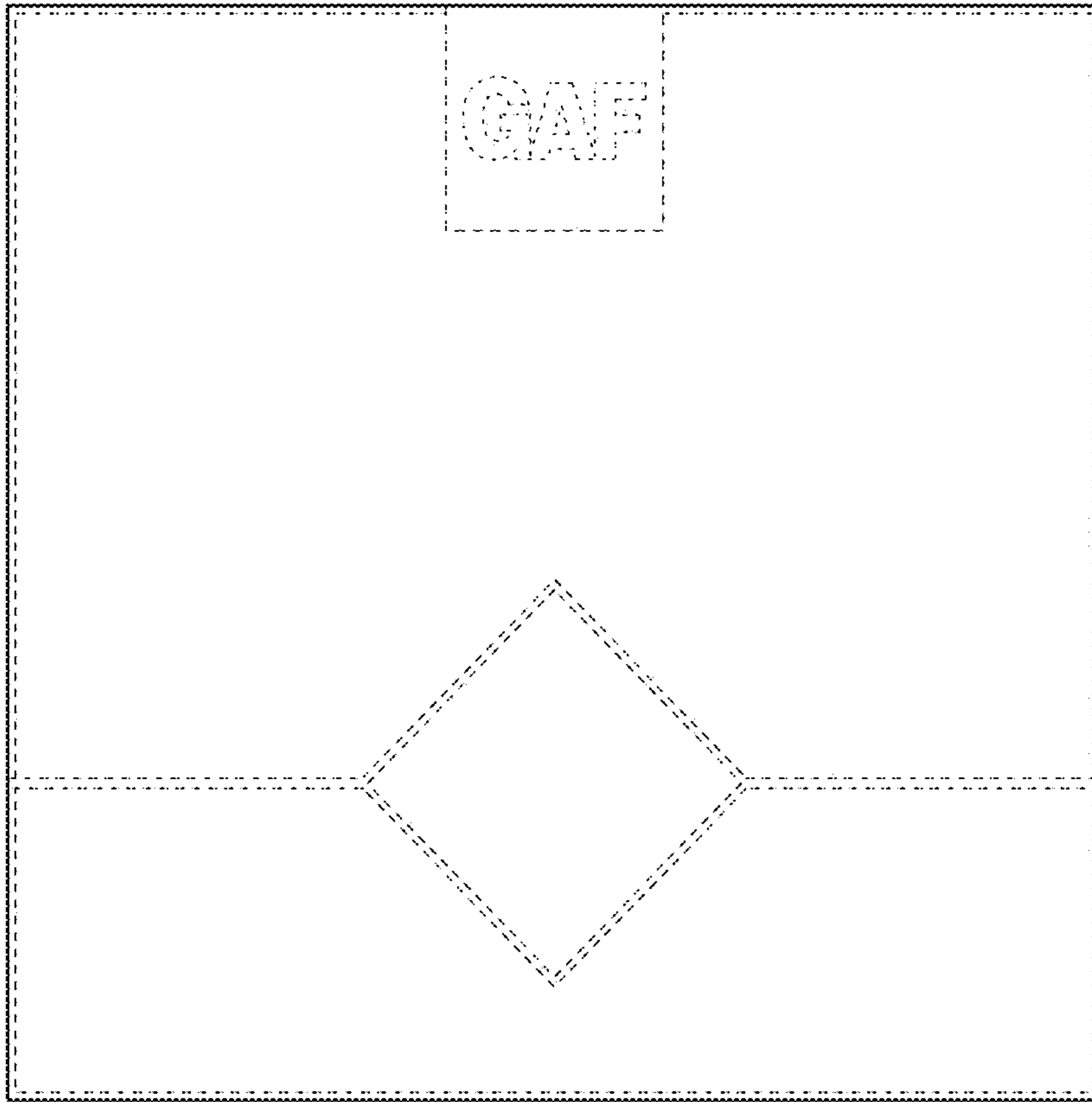

FIG. 4

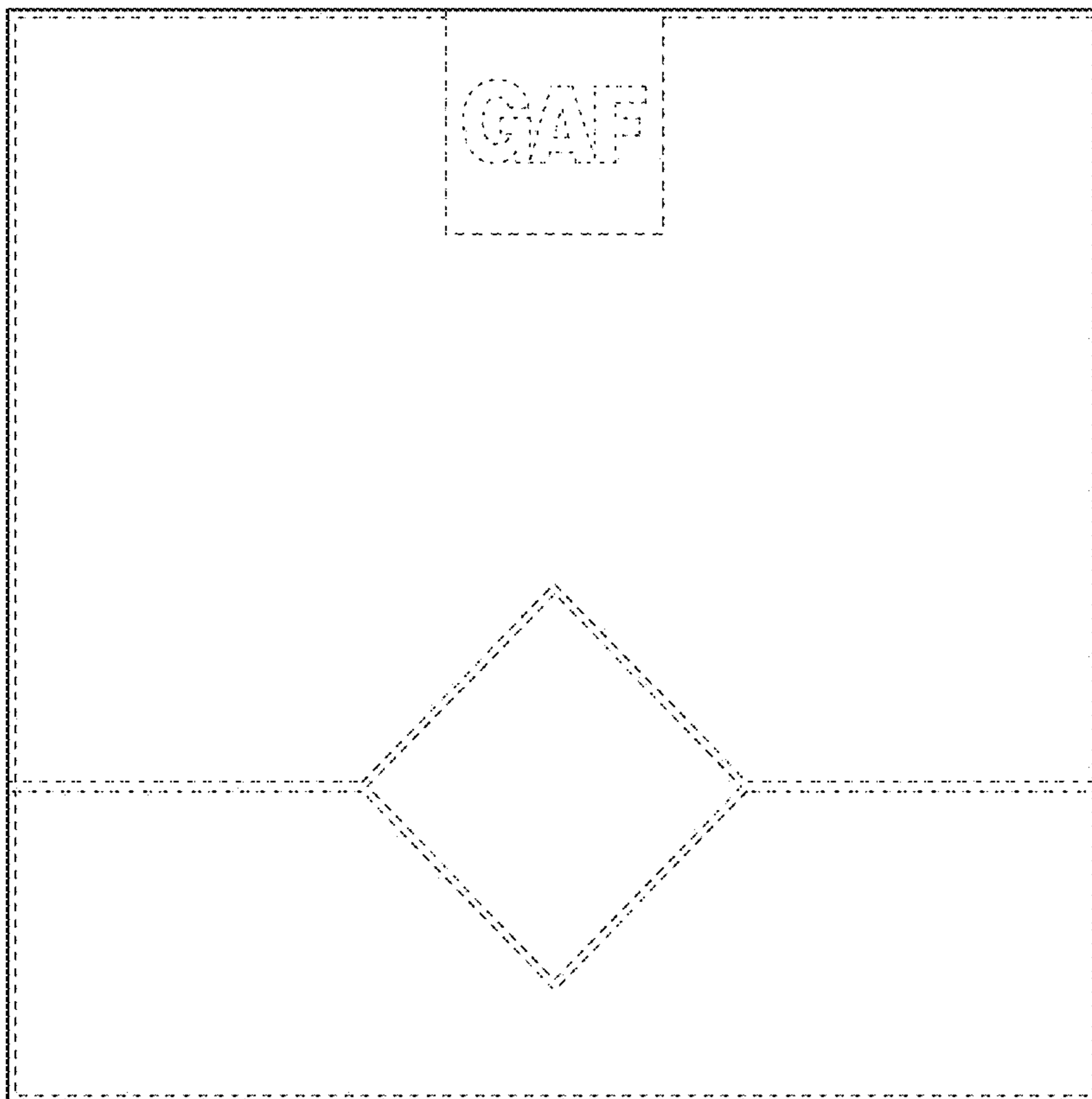

FIG. 5

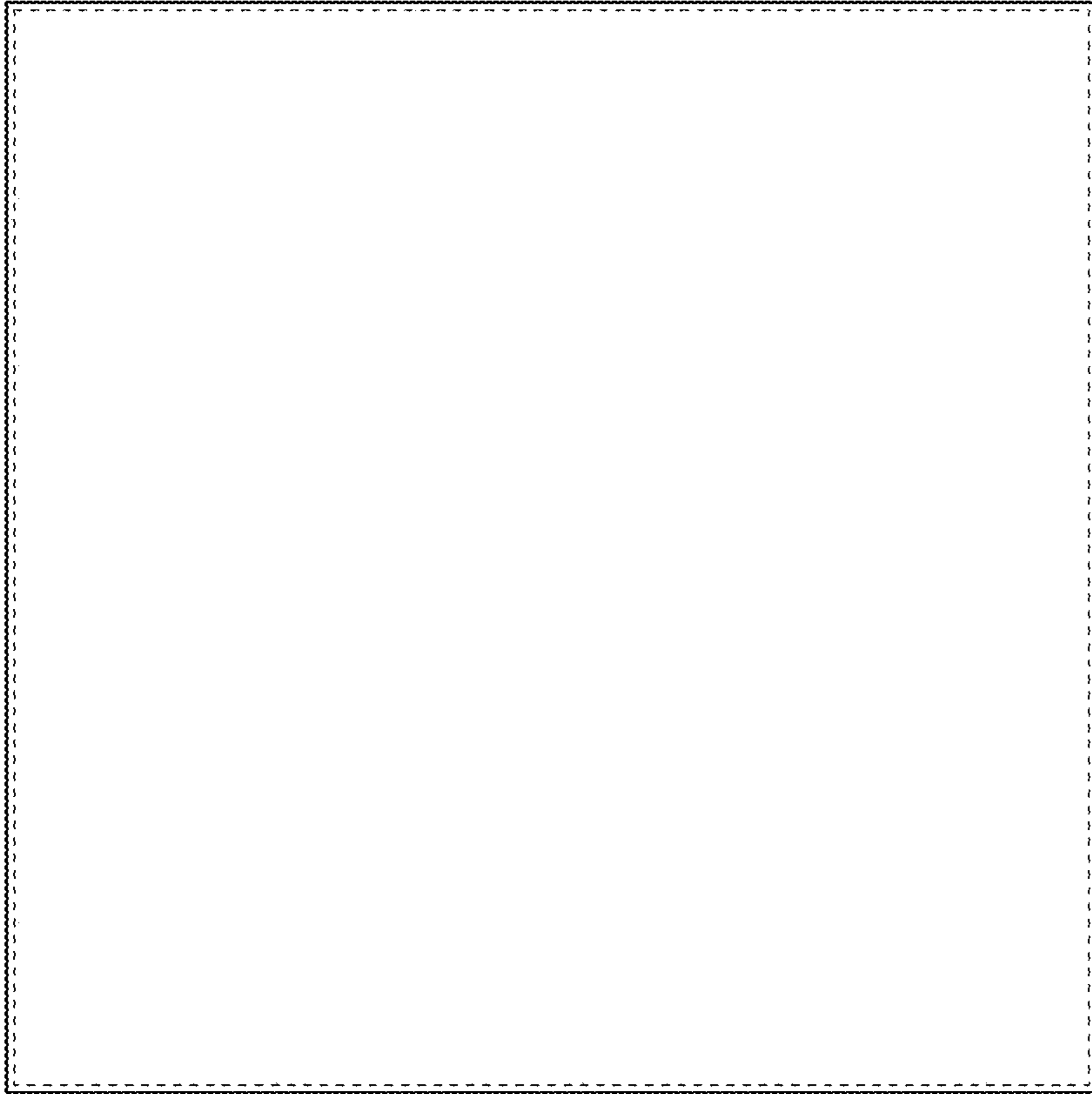

FIG. 6

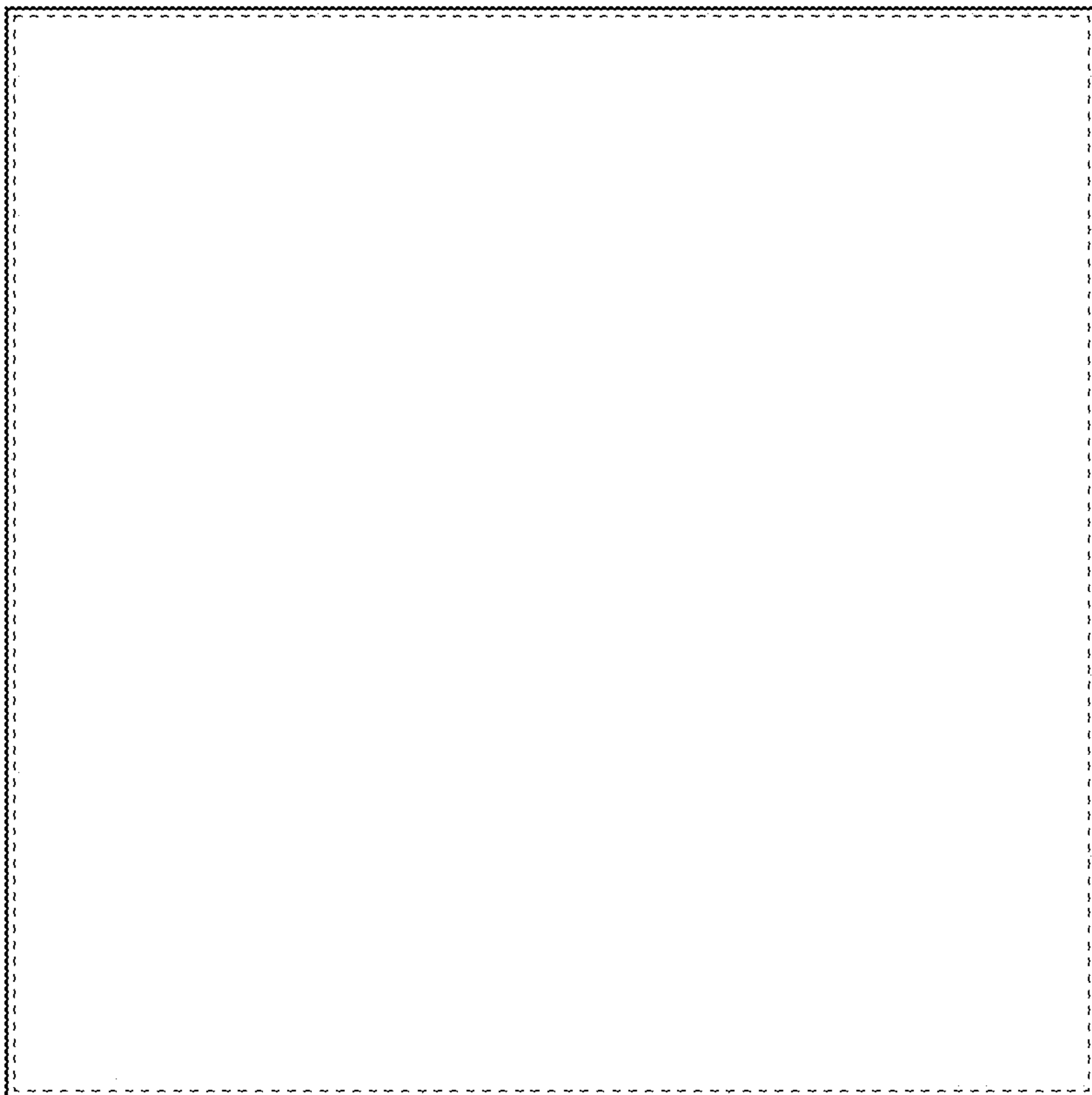

FIG. 7

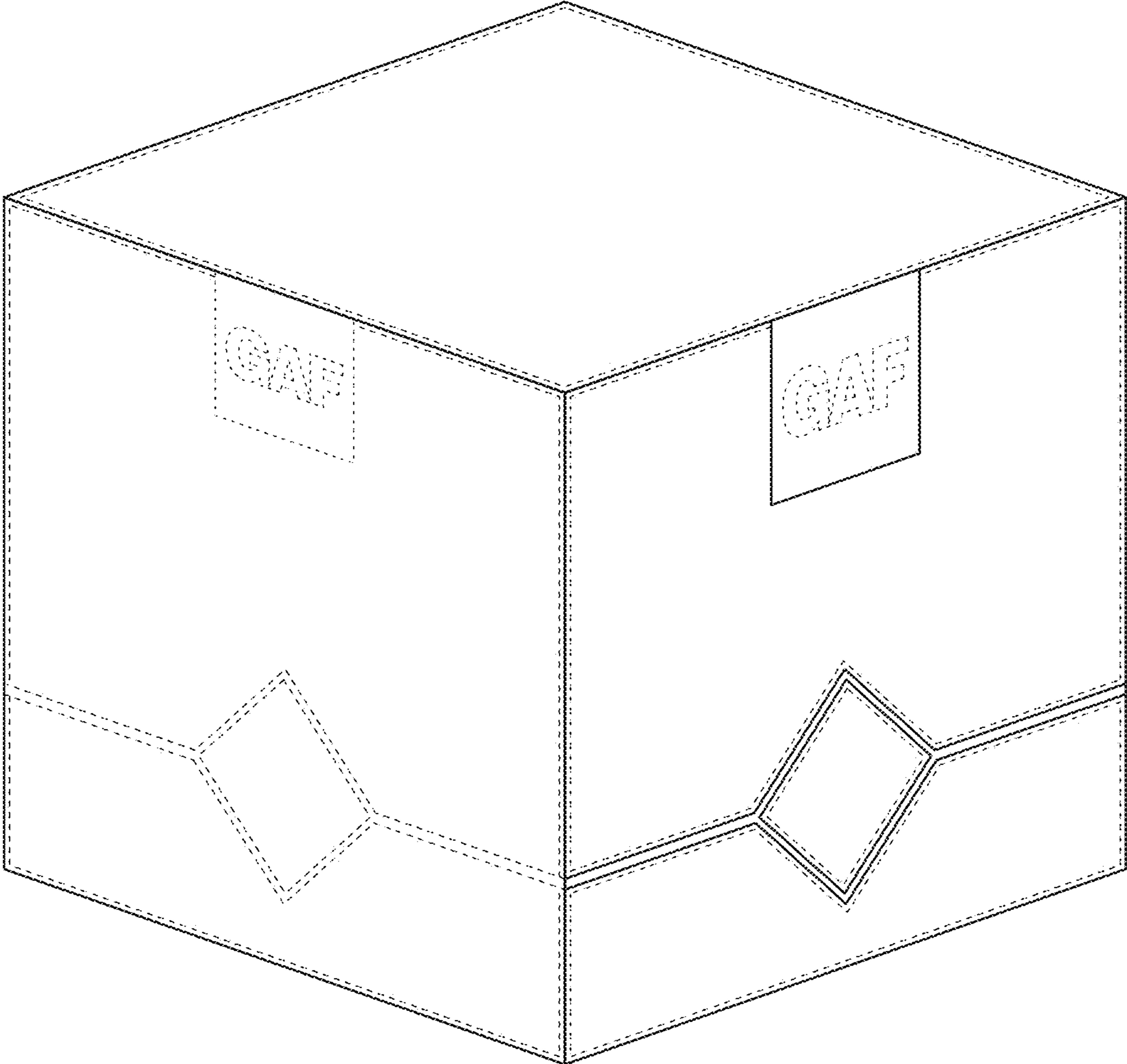

FIG. 8

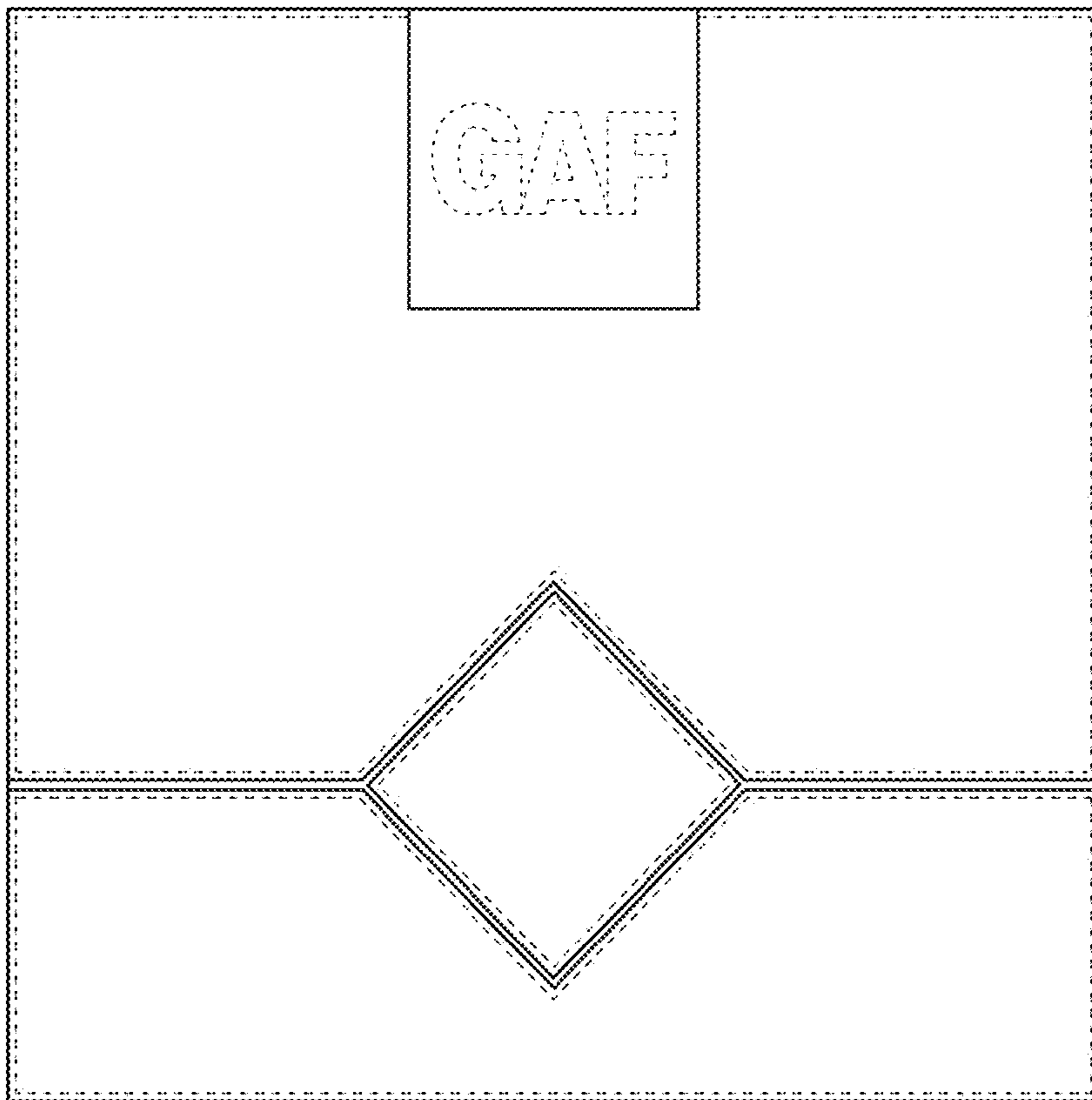

FIG. 9

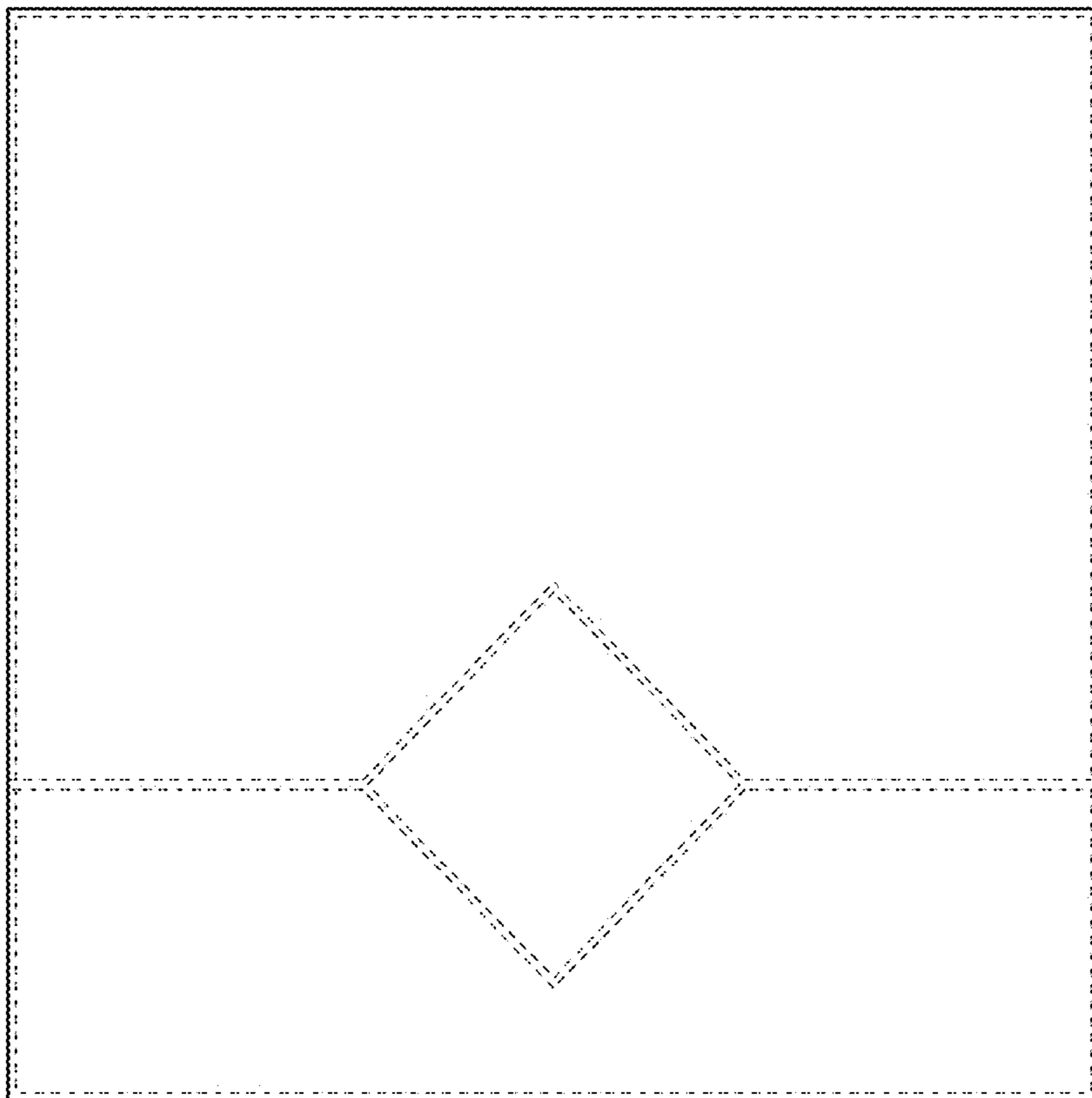

FIG. 10

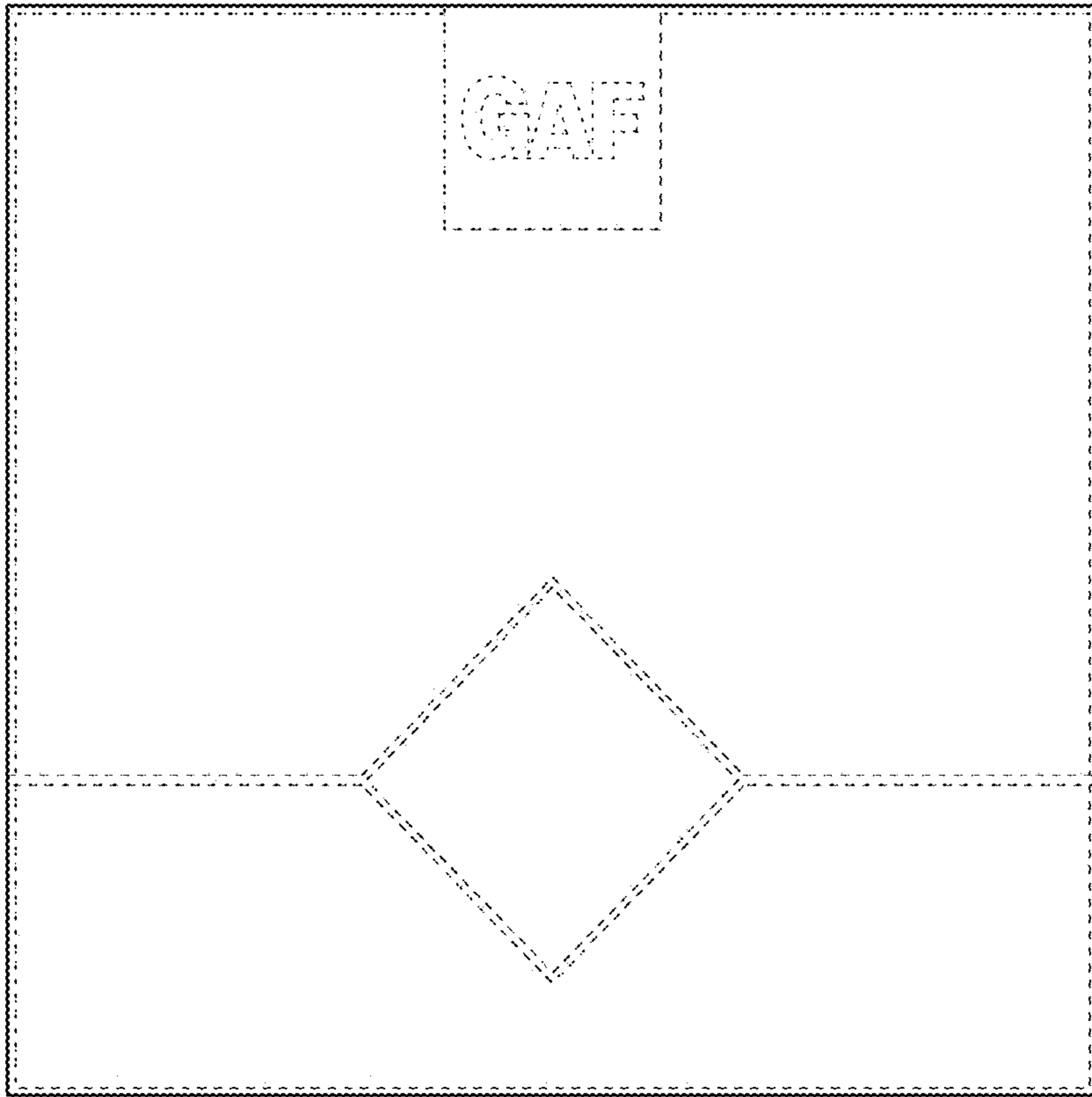

FIG. 11

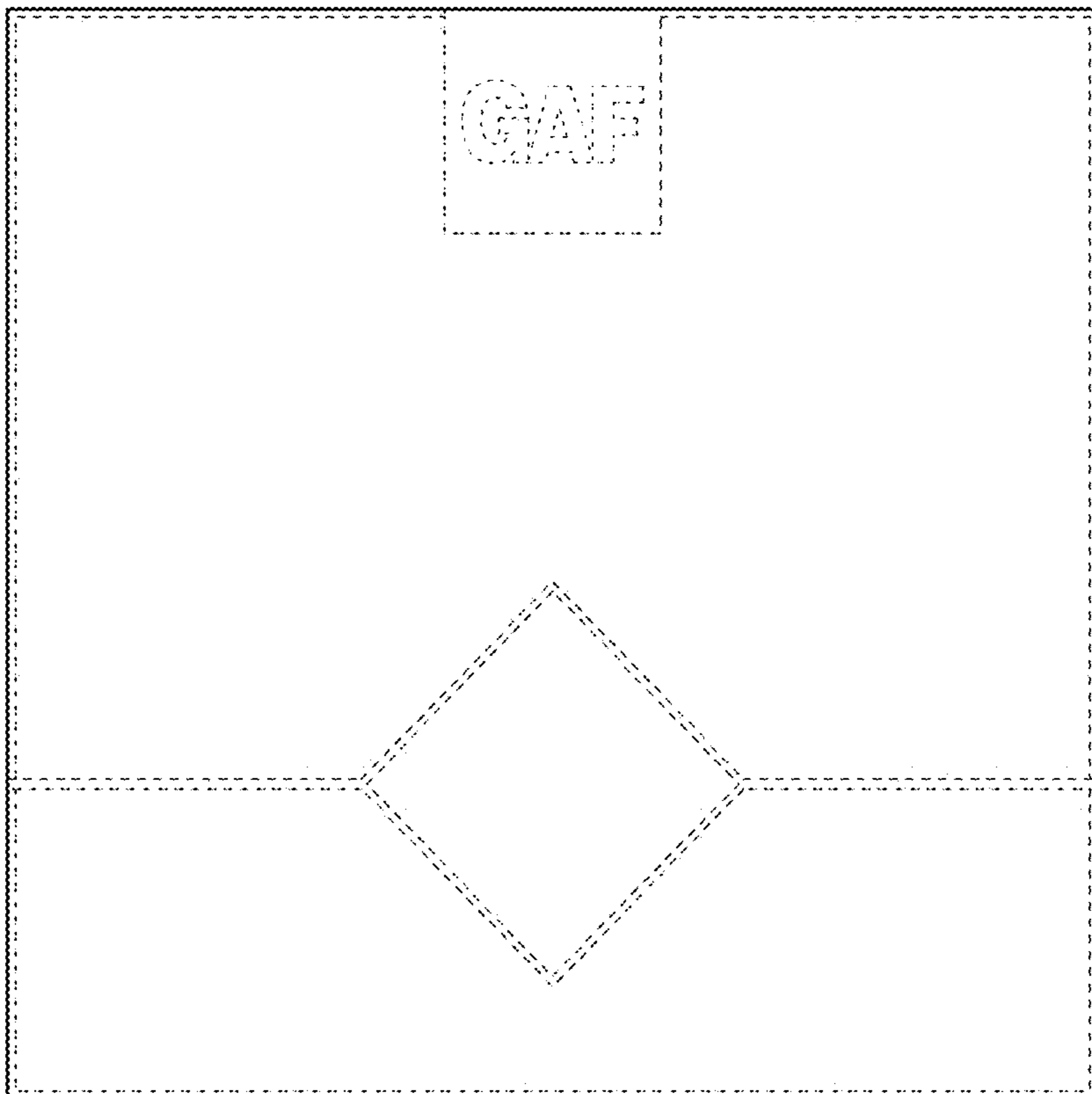

FIG. 12

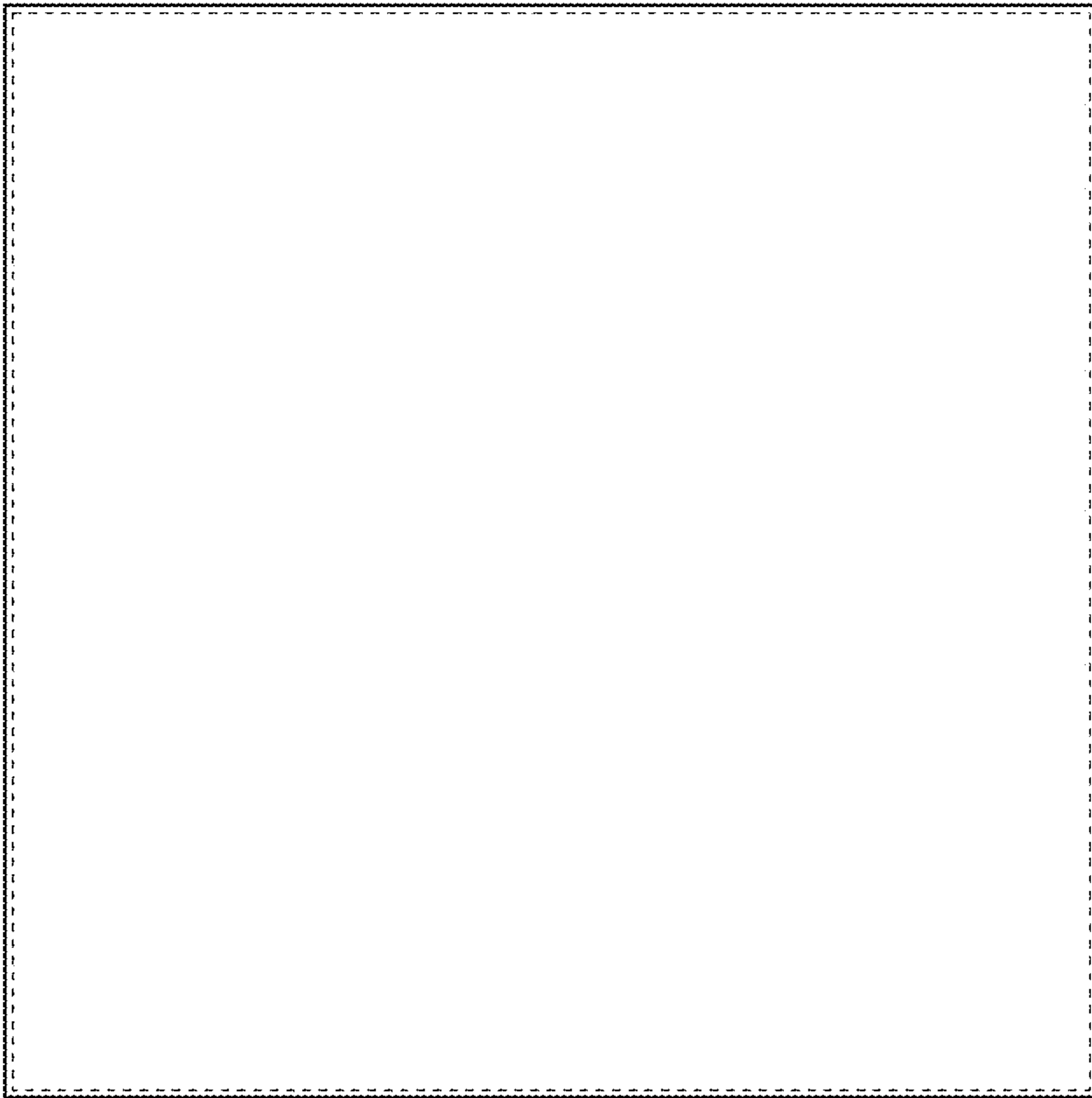

FIG. 13

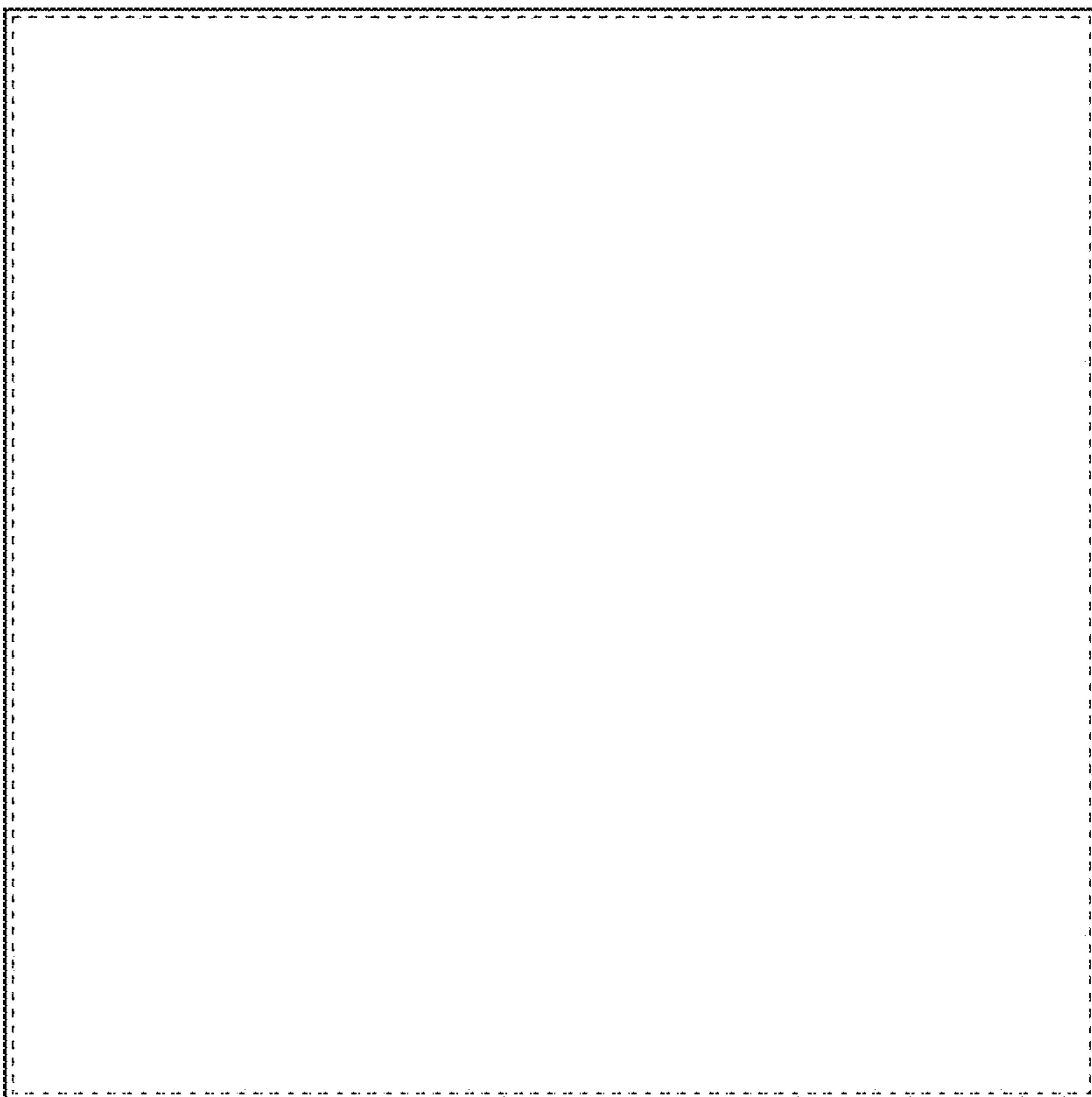

FIG. 14