



US00D929845S

(12) **United States Design Patent**
Gori et al.

(10) **Patent No.:** **US D929,845 S**

(45) **Date of Patent:** **** Sep. 7, 2021**

(54) **DRAIN HANDLE**

(71) Applicant: **Leaf Home Safety Solutions, LLC.**,
Hudson, OH (US)

(72) Inventors: **Michael Gori**, Hudson, OH (US);
Thomas Victor Czerny, Streetsboro,
OH (US)

(73) Assignee: **Leaf Home Safety Solutions, LLC**,
Hudson, OH (US)

(**) Term: **15 Years**

(21) Appl. No.: **29/715,716**

(22) Filed: **Dec. 4, 2019**

(51) **LOC (13) Cl.** **08-06**

(52) **U.S. Cl.**
USPC **D8/311**

(58) **Field of Classification Search**
USPC D8/107, 300, 301, 307, 310, 311, 312;
D23/250-254, 421; D7/393, 394, 396,
D7/406
CPC ... Y10T 292/57; Y10T 292/82; Y10T 16/469;
Y10T 16/44; Y10T 16/476; Y10T
74/2084; Y10T 292/85; Y10T 74/2087;
Y10T 16/4713; Y10T 16/506; Y10T
74/20876; Y10T 74/20612; Y10T
70/5765; Y10T 16/459; Y10T 74/2066;
Y10T 16/487; Y10T 74/20822
See application file for complete search history.

(56) **References Cited**

U.S. PATENT DOCUMENTS

D168,902 S * 2/1953 Mundt D8/311
D202,273 S * 9/1965 Brendgord D8/311

D227,568 S * 7/1973 Thorp D23/252
3,791,402 A * 2/1974 Shuler F16K 31/602
137/315.41
D368,957 S * 4/1996 Bavoso D23/252
D457,416 S * 5/2002 Caspersz D8/311
D691,456 S * 10/2013 Watkins D8/311
D748,746 S * 2/2016 Eder D21/694
2016/0339455 A1 * 11/2016 Lin E03C 1/0408

* cited by examiner

Primary Examiner — Lauren R Calve

(74) *Attorney, Agent, or Firm* — Benesch, Friedlander,
Coplan & Aronoff LLP

(57) **CLAIM**

The ornamental design of a drain handle, as shown and described.

DESCRIPTION

FIG. 1 is a perspective view of a drain handle;
FIG. 2 is another perspective view of the drain handle of FIG. 1;
FIG. 3 is a front elevation view of the drain handle of FIG. 1;
FIG. 4 is a rear elevation view of the drain handle of FIG. 1;
FIG. 5 is a left-side elevation view of the drain handle of FIG. 1;
FIG. 6 is a right-side elevation view of the drain handle of FIG. 1;
FIG. 7 is a top plan view of the drain handle of FIG. 1; and,
FIG. 8 is a bottom plan view of the drain handle of FIG. 1.
The broken lines shown in the drawings depict portions of the drain handle that form no part of the claim.

1 Claim, 8 Drawing Sheets

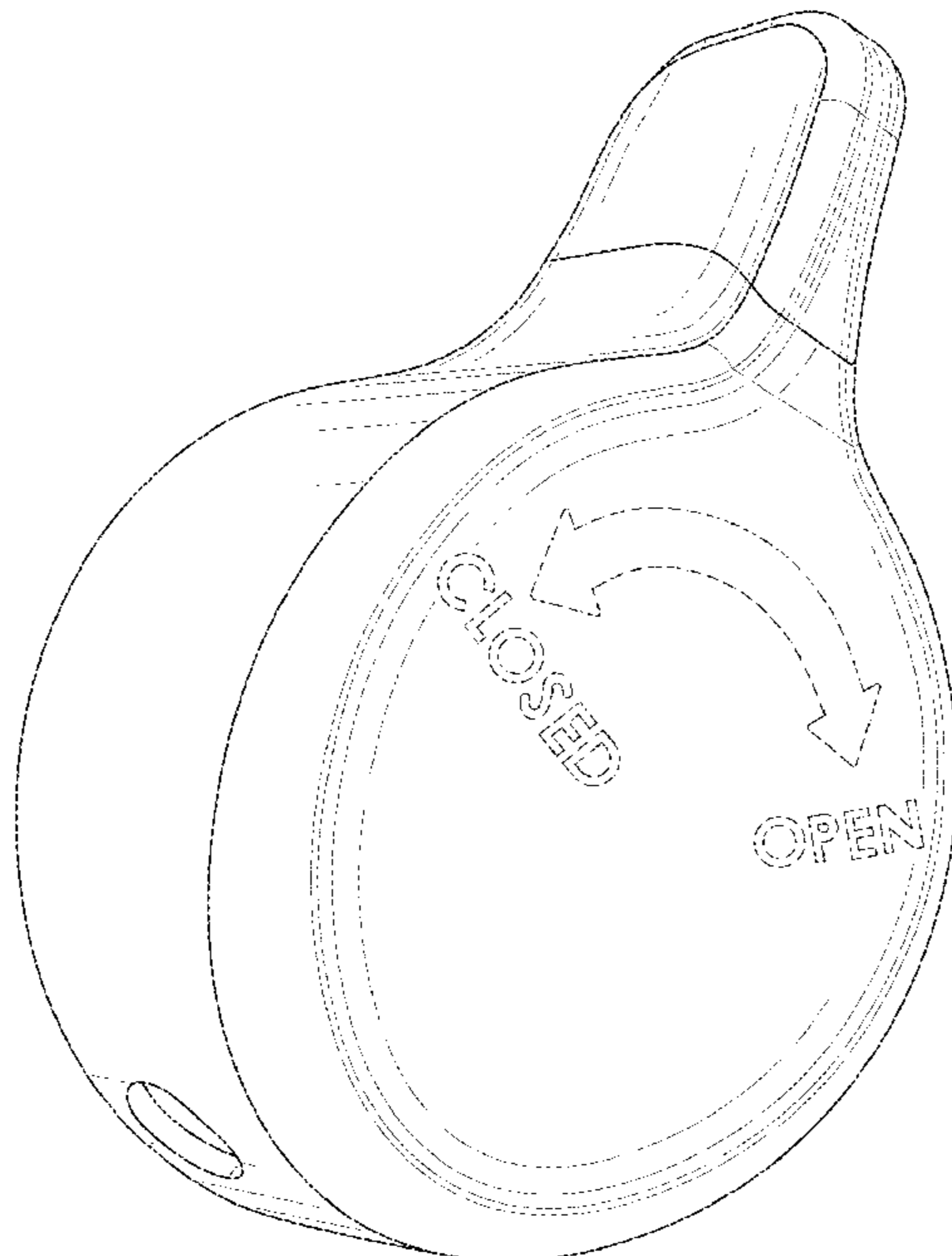

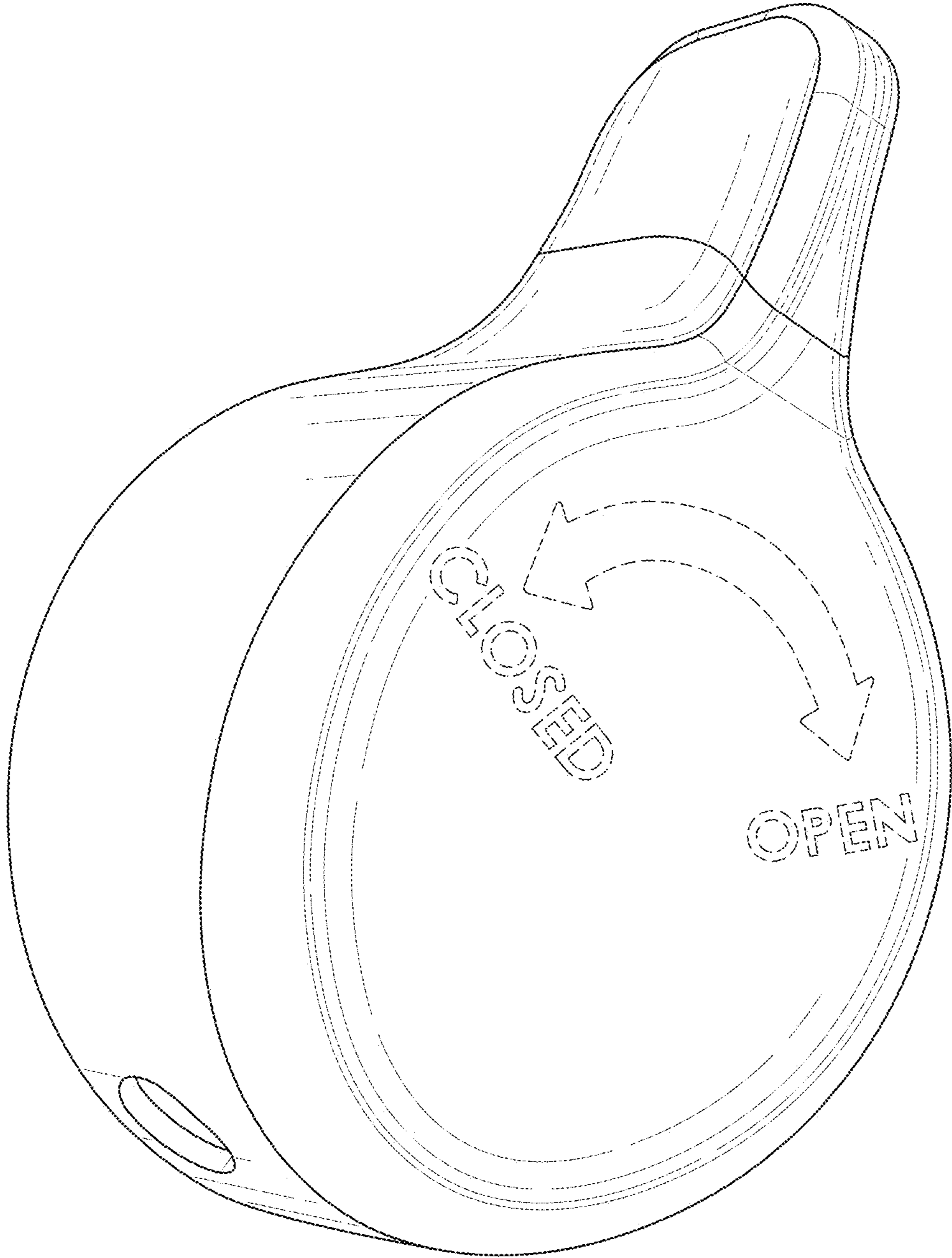

FIG. 1

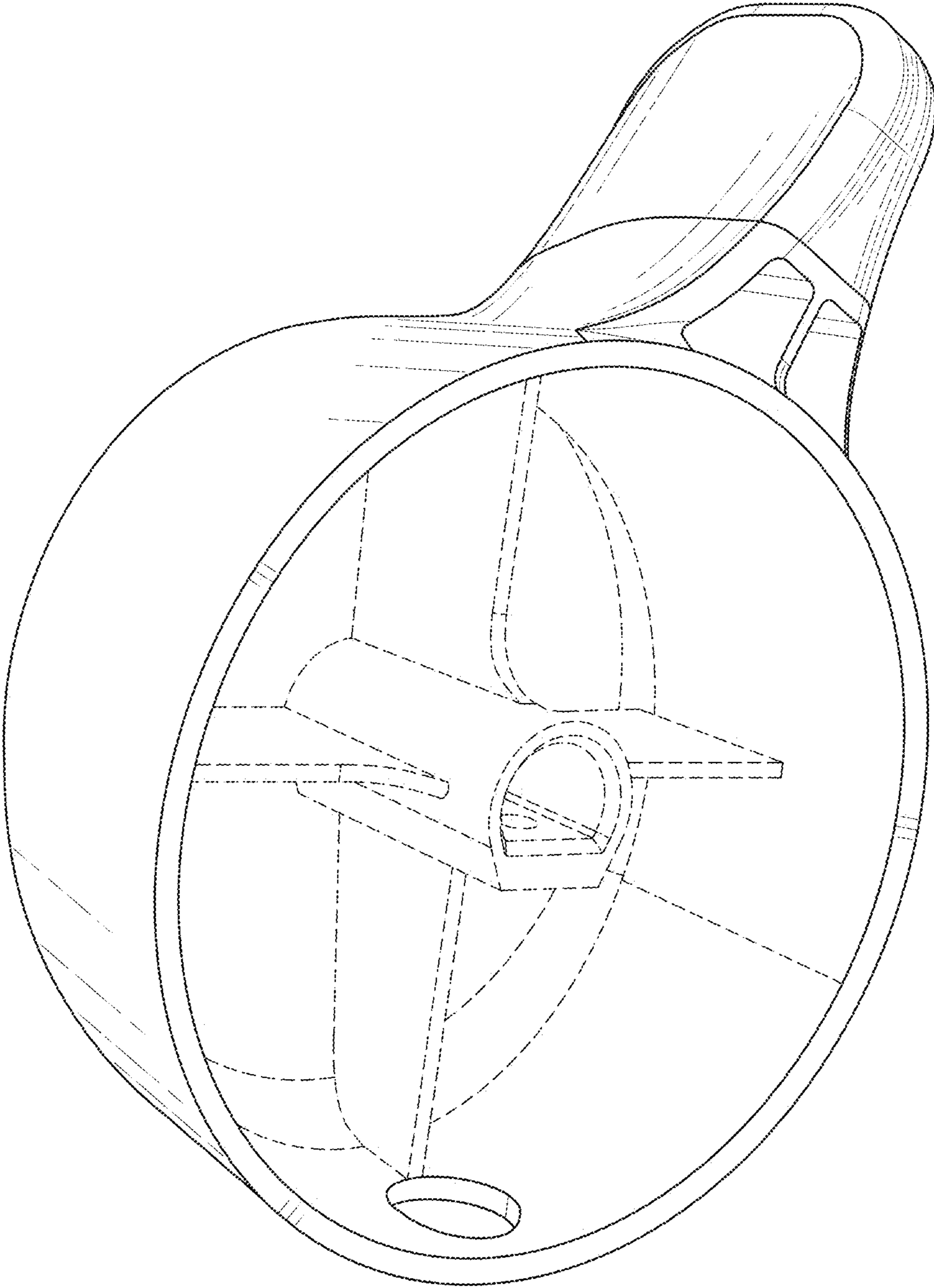

FIG. 2

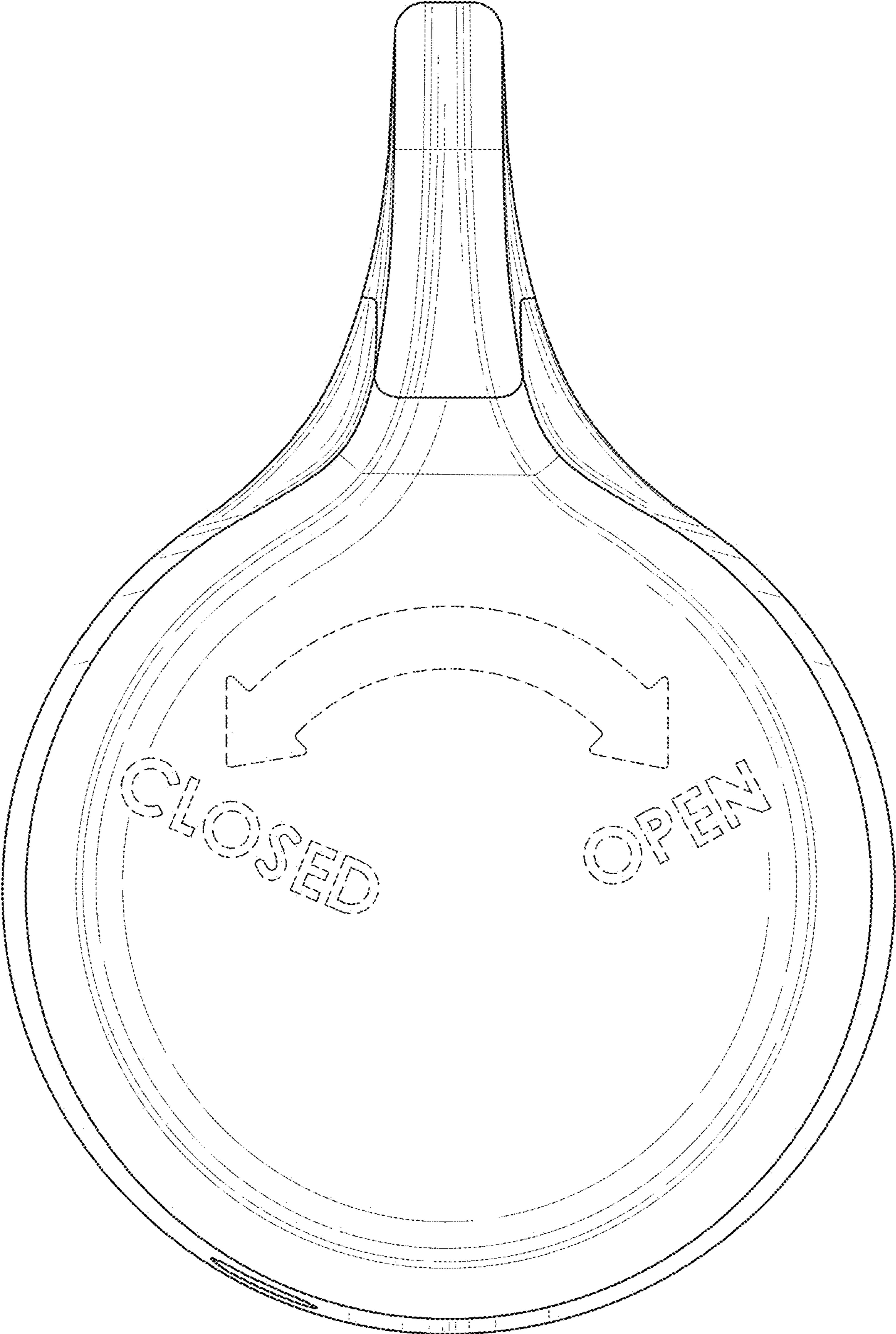

FIG. 3

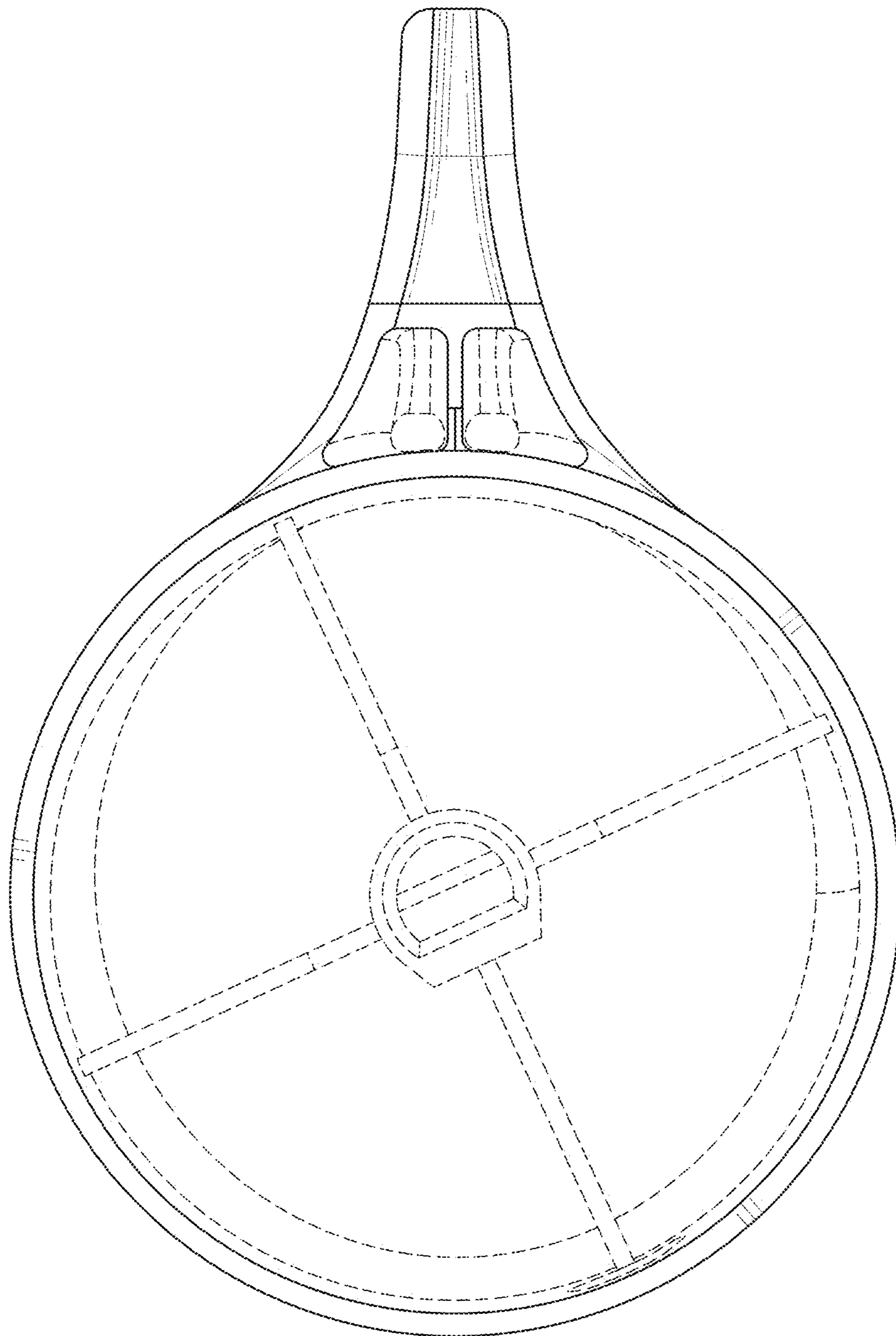

FIG. 4

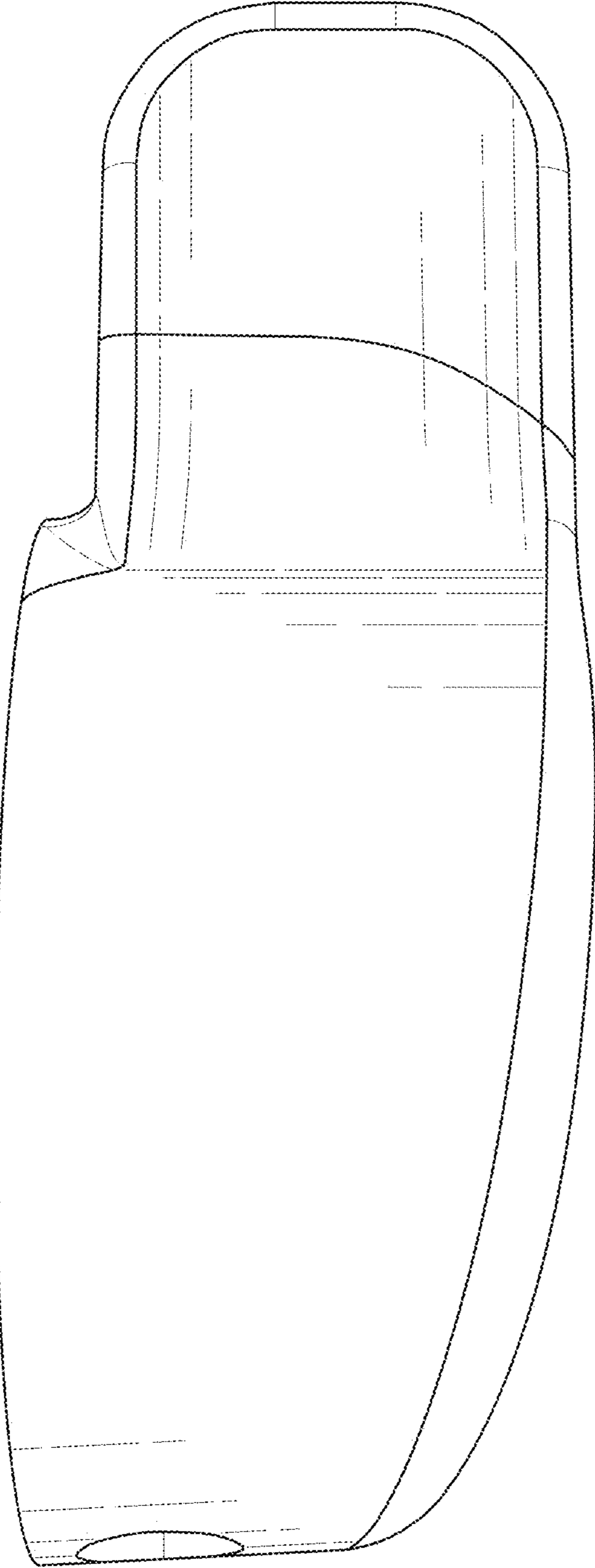

FIG. 5

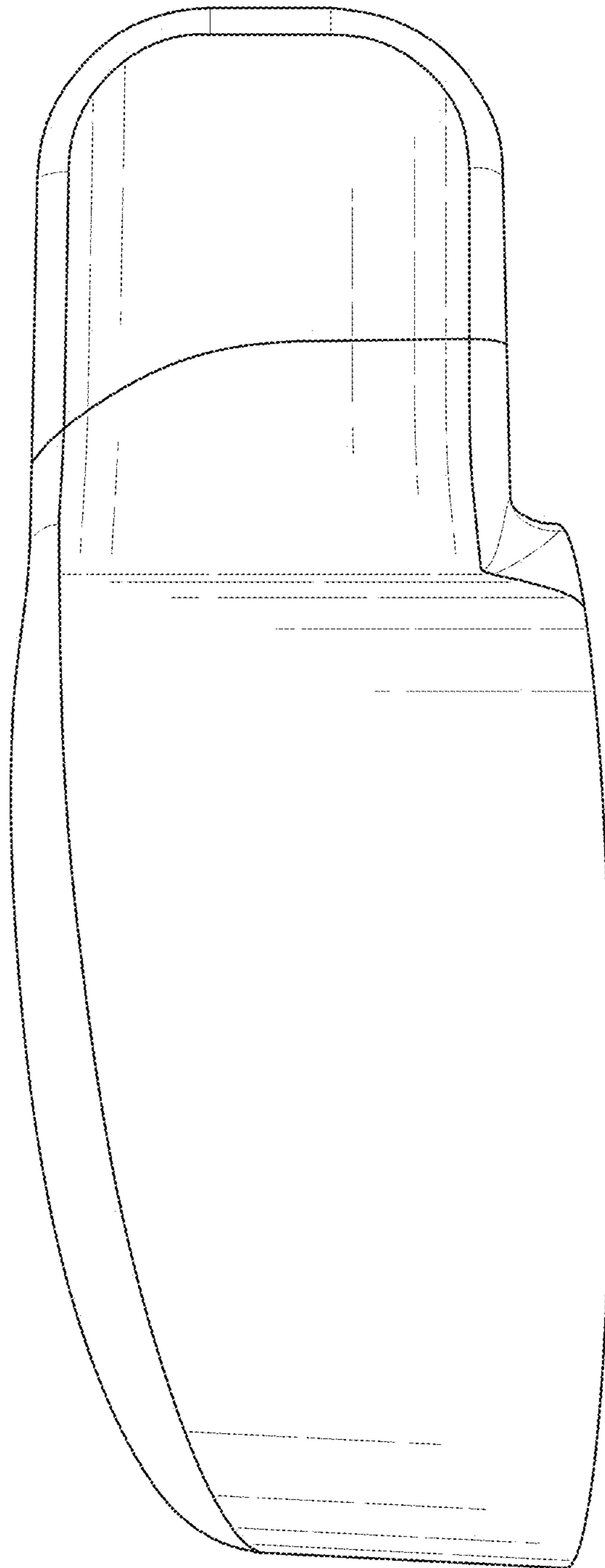

FIG. 6

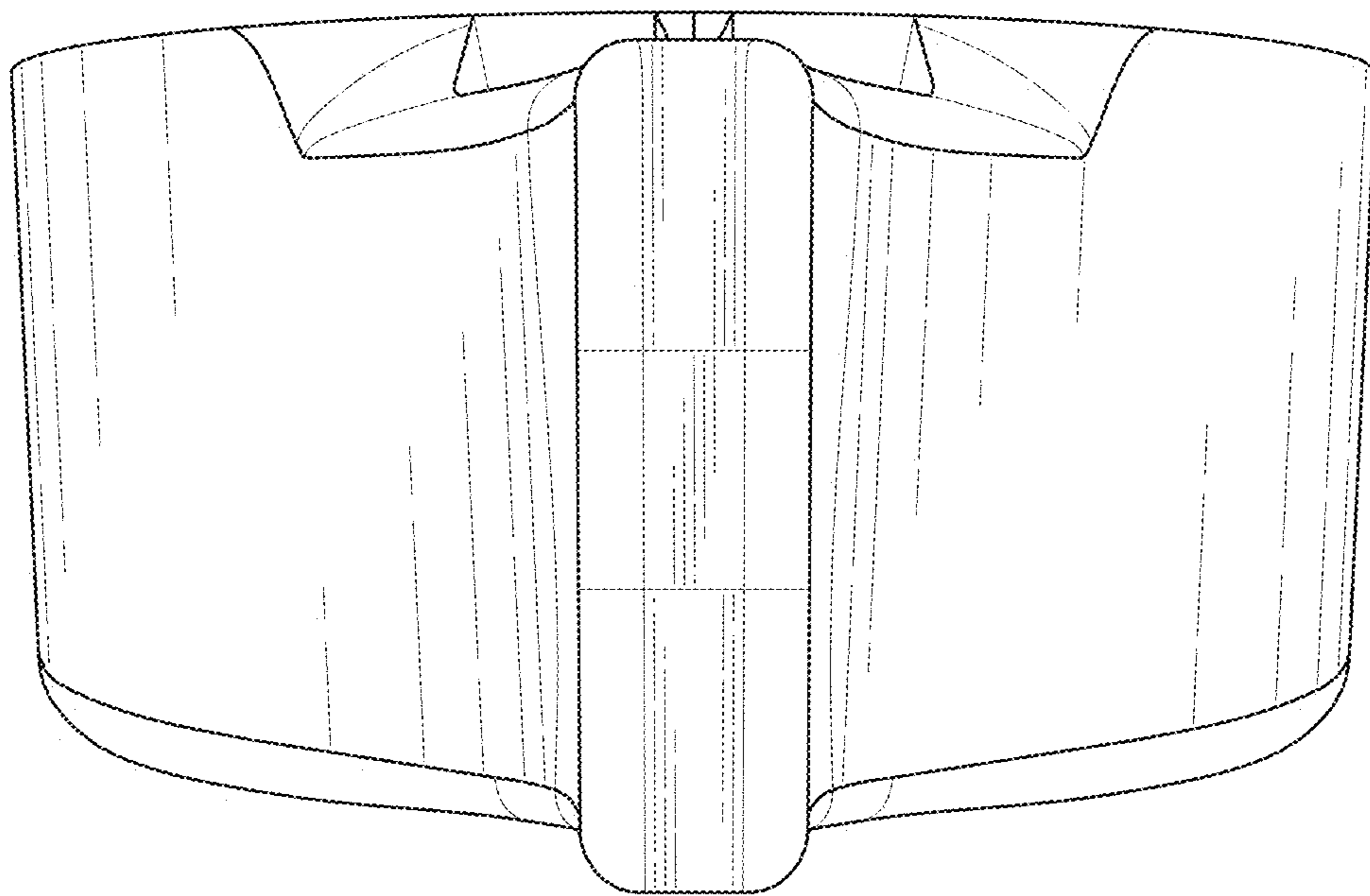

FIG. 7

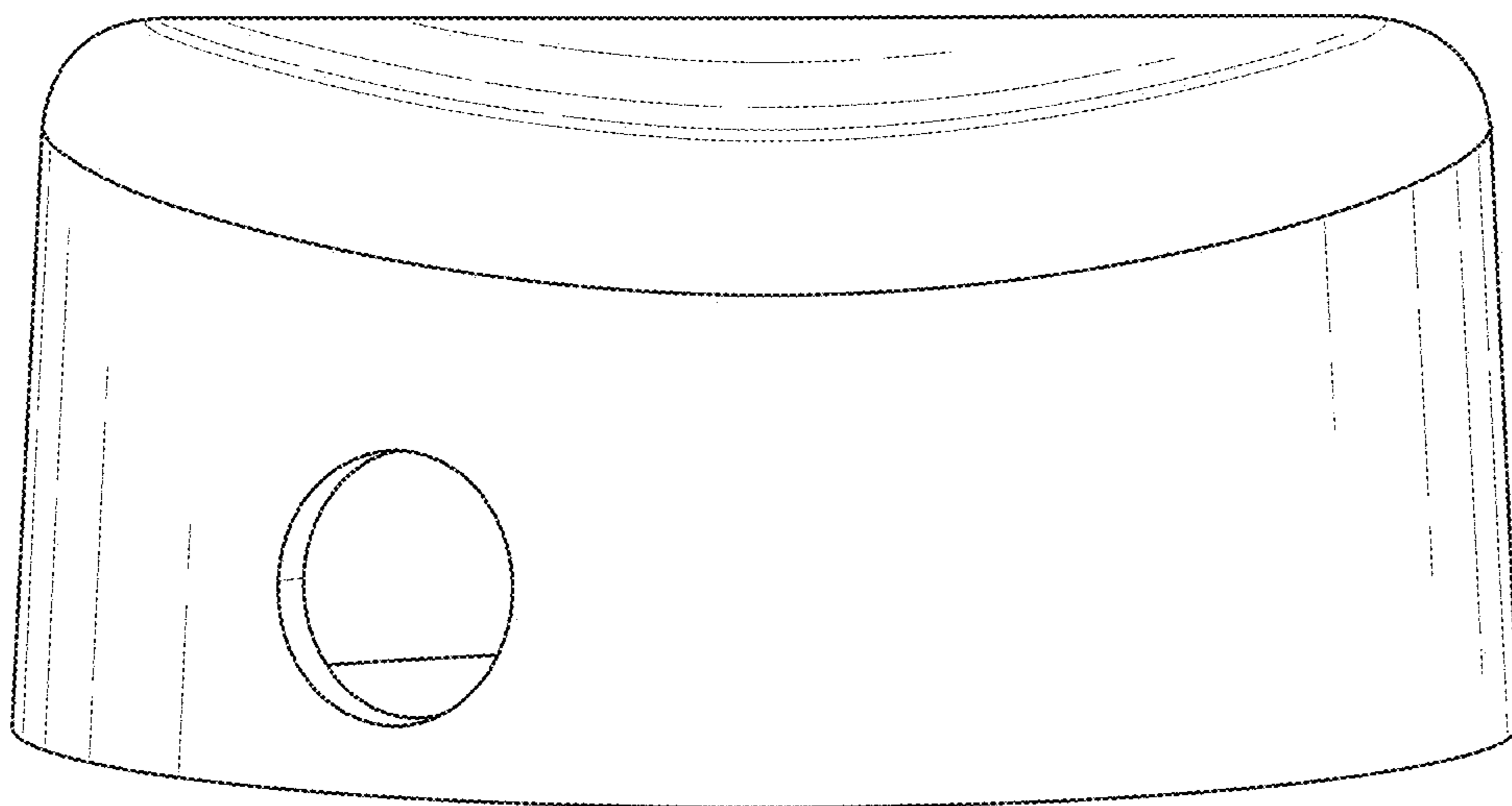

FIG. 8