



US00D929842S

(12) **United States Design Patent** (10) **Patent No.:** **US D929,842 S**  
**Zachariassen et al.** (45) **Date of Patent:** **\*\* Sep. 7, 2021**

- (54) **KNIFE SHARPENER**
- (71) Applicant: **Darex, LLC**, Ashland, OR (US)
- (72) Inventors: **Joseph Todd Zachariassen**, Medford, OR (US); **Steven Lee Baker**, Medford, OR (US)
- (73) Assignee: **Darex, LLC**, Ashland, OR (US)
- (\*\*) Term: **15 Years**
- (21) Appl. No.: **29/729,914**
- (22) Filed: **Mar. 31, 2020**
- (51) **LOC (13) Cl.** ..... **08-05**
- (52) **U.S. Cl.**  
USPC ..... **D8/93**
- (58) **Field of Classification Search**  
USPC ..... D8/63, 90, 91, 92, 93  
CPC .... B24B 3/54; B24B 3/36; B24B 3/58; B24B 3/00; B24B 23/08; B24B 15/00; B24B 15/06; B24B 15/063; B24B 15/08  
See application file for complete search history.

D626,397 S *	11/2010	Smith	.....	D8/93
D640,523 S *	6/2011	Stutz	.....	D8/93
D640,909 S *	7/2011	Stutz	.....	D8/93
D680,846 S *	4/2013	Smith	.....	D8/93
D763,650 S *	8/2016	Severinson	.....	D8/93
D773,913 S *	12/2016	Severinson	.....	D8/93
D884,450 S *	5/2020	Zemel	.....	D8/93

OTHER PUBLICATIONS

Amazon.com\_ Work Sharp Handheld Pivot Pro Knife & Tool Sharpener, Date First Available Sep. 1, 2019.\*

\* cited by examiner

Primary Examiner — Philip S Hyder

(74) Attorney, Agent, or Firm — Hall Estill Law Firm

(57) **CLAIM**

The ornamental design for a knife sharpener, as shown and described.

**DESCRIPTION**

FIG. 1 is a front isometric view of a knife sharpener, embodying the new design.

FIG. 2 is a front view of the design of FIG. 1.

FIG. 3 is a rear view of the design of FIG. 1.

FIG. 4 is a top plan view of the design of FIG. 1.

FIG. 5 is a bottom plan view of the design of FIG. 1.

FIG. 6 is a right side view of the design of FIG. 1; and,

FIG. 7 is a left side view of the design of FIG. 1.

**1 Claim, 6 Drawing Sheets**

(56) **References Cited**

U.S. PATENT DOCUMENTS

D525,509 S *	7/2006	Weschenfelder	.....	D8/91
D603,679 S *	11/2009	Smith	.....	D8/93
D604,134 S *	11/2009	Smith	.....	D8/63
D624,799 S *	10/2010	De Bretton Gordon	.....	D8/93

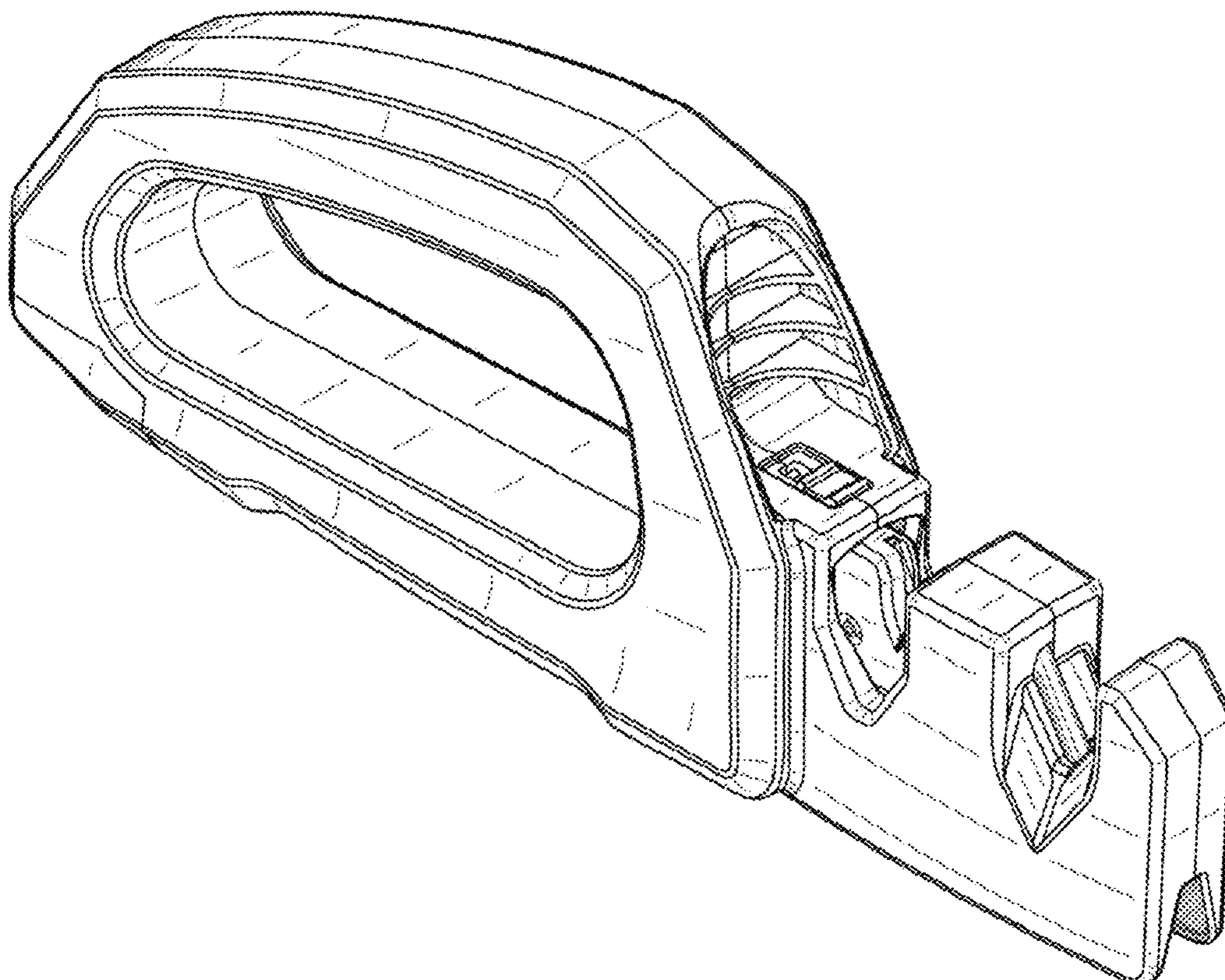

FIG. 1

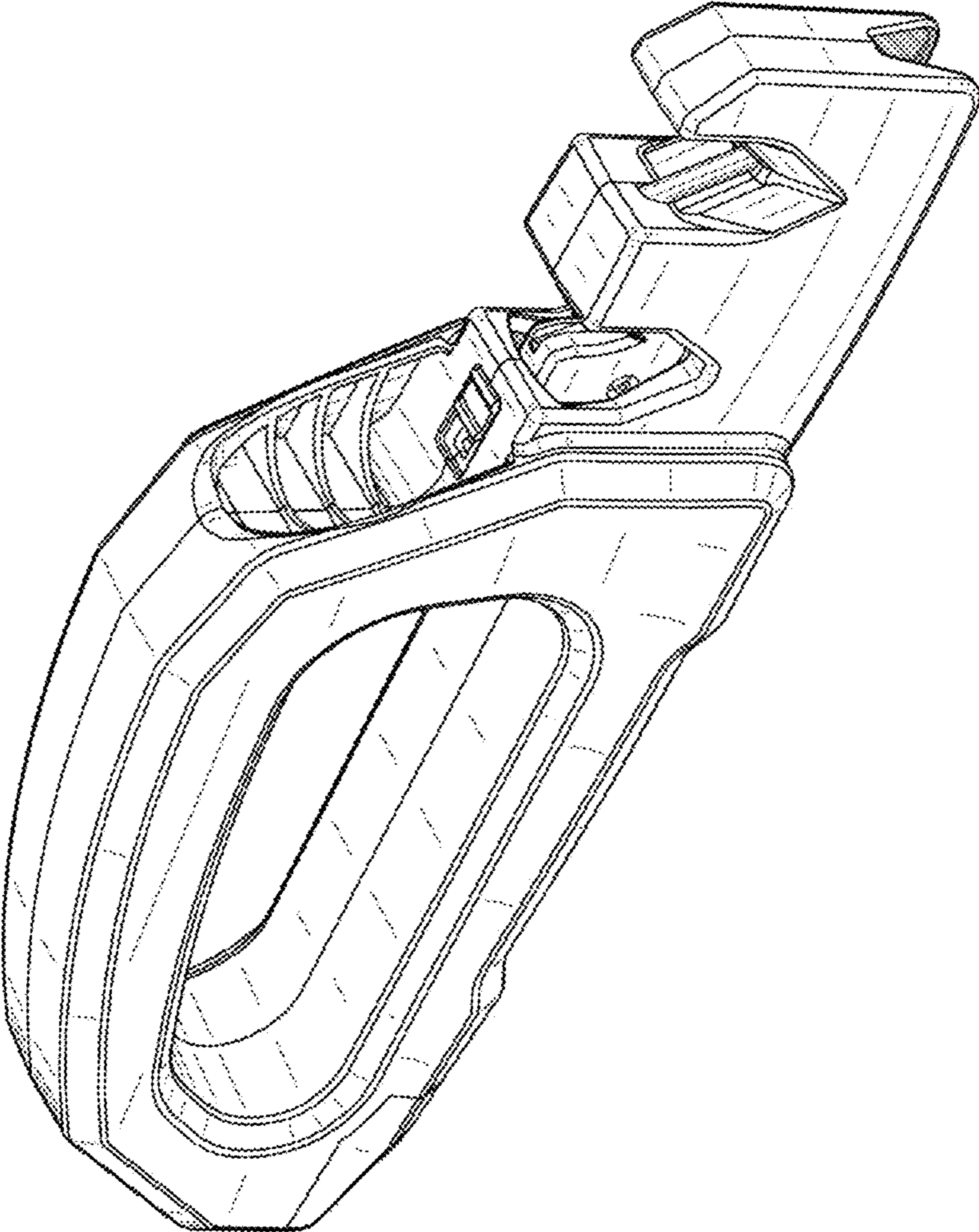

FIG. 2

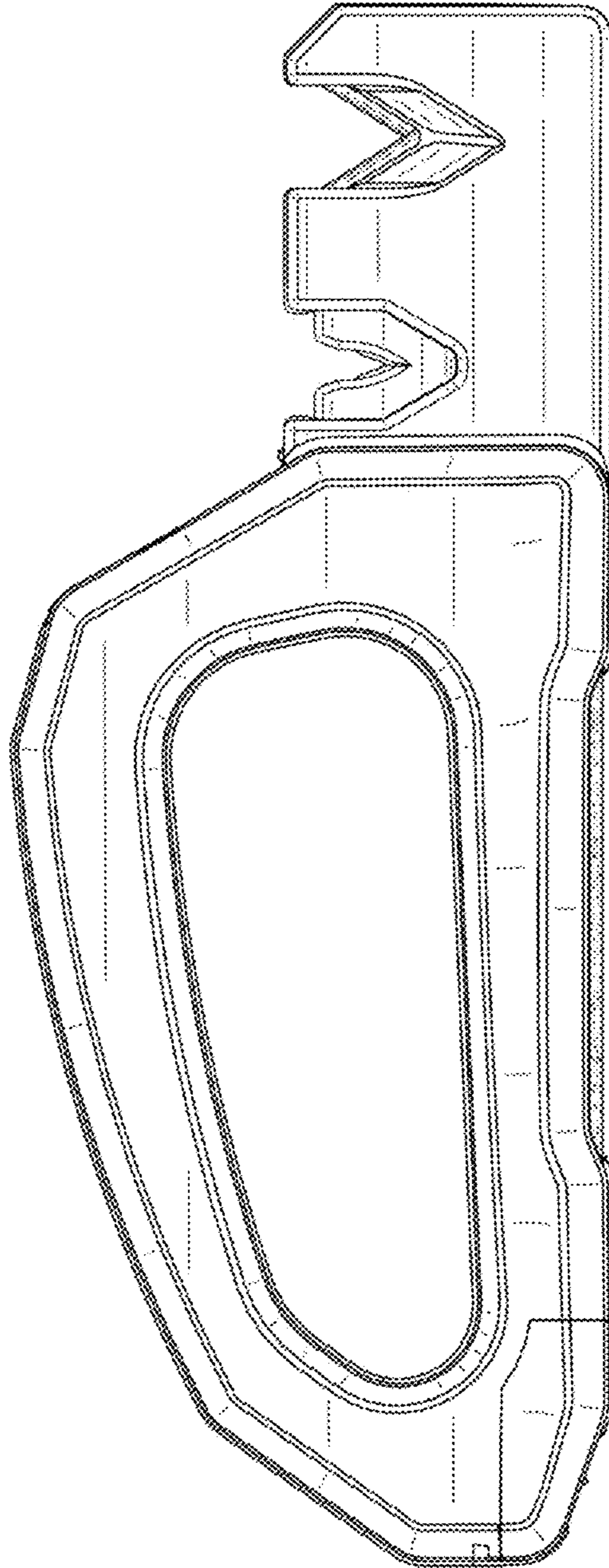

FIG. 3

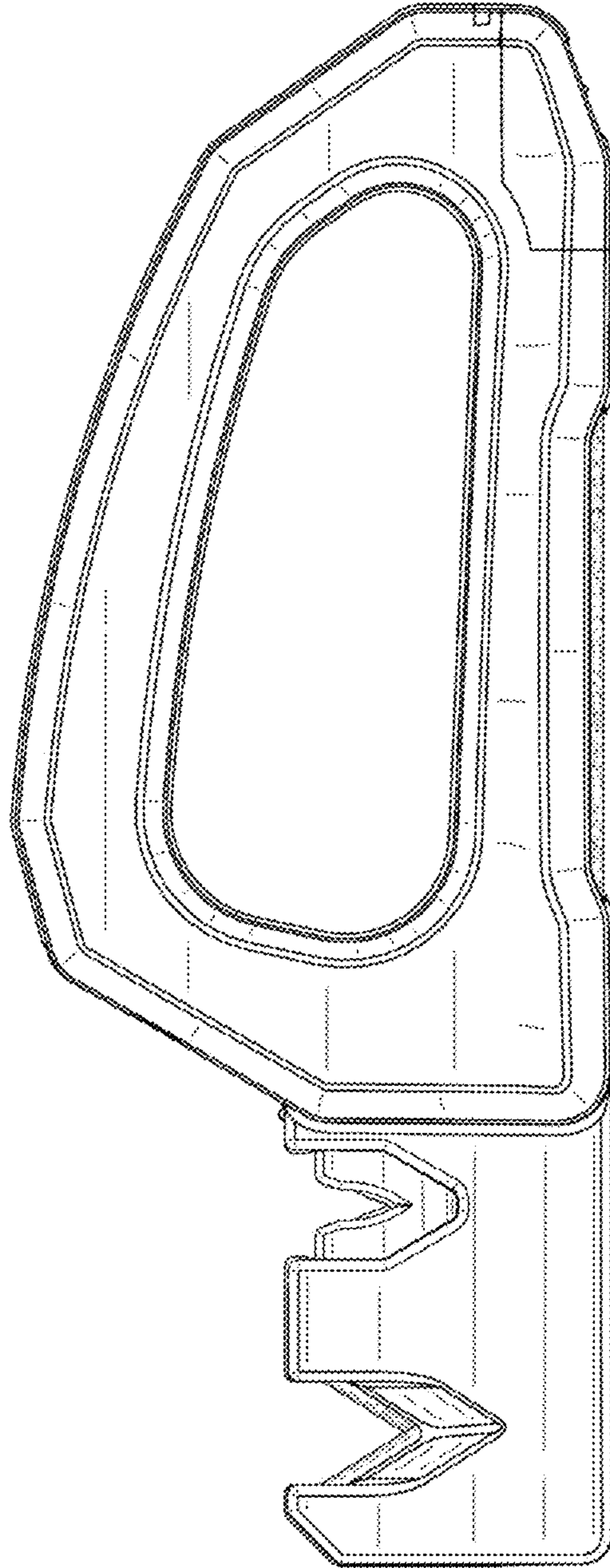

FIG. 4

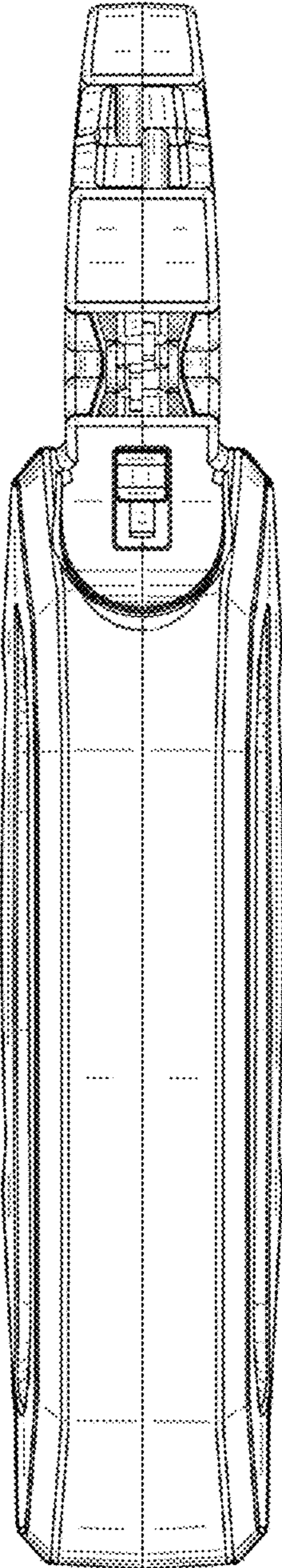

FIG. 5

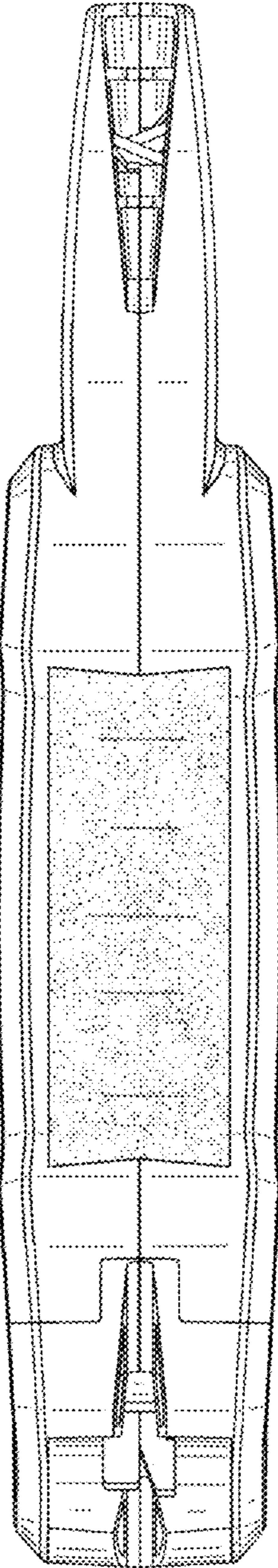

FIG. 7

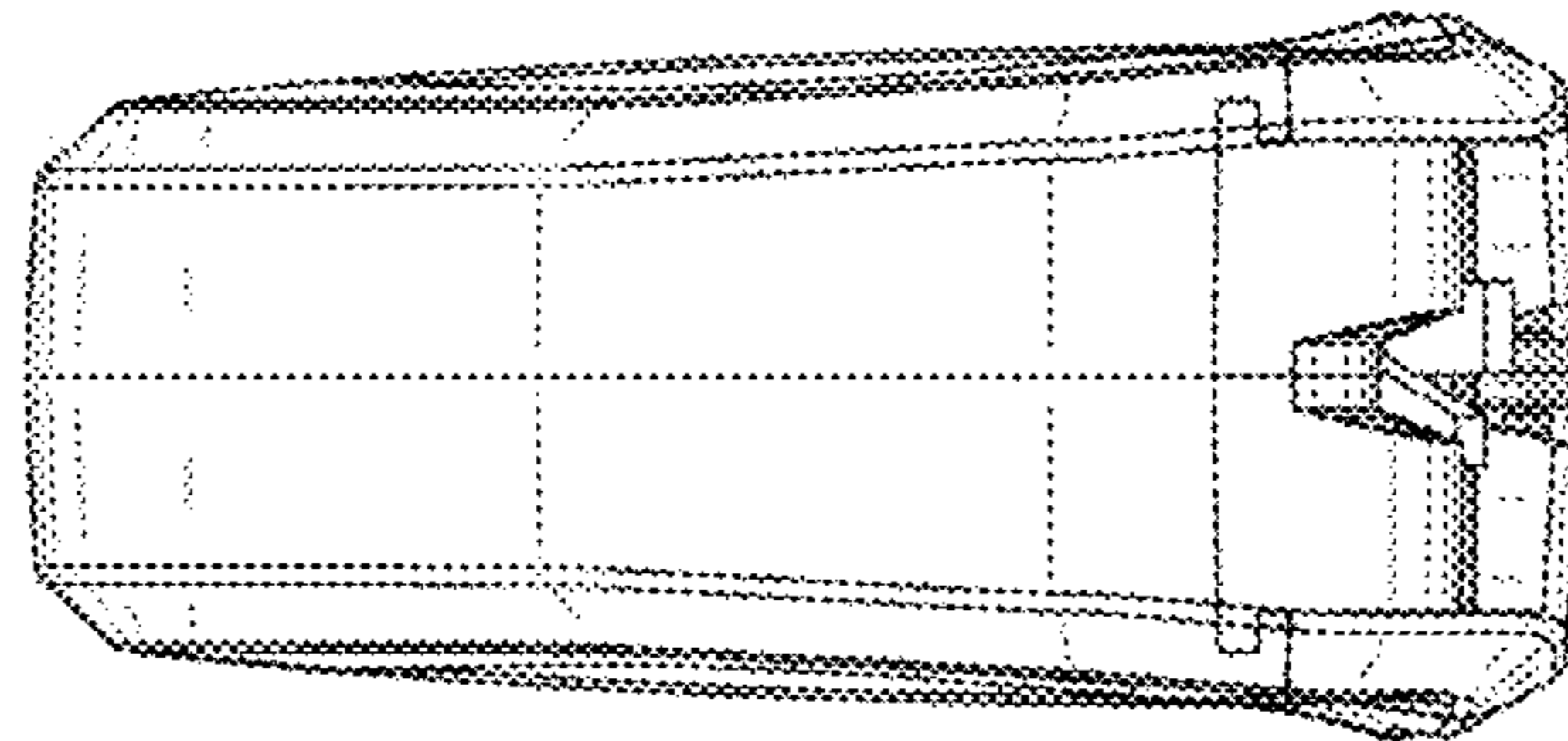

FIG. 6

