



US00D929825S

(12) **United States Design Patent** (10) **Patent No.:** **US D929,825 S**
Lu (45) **Date of Patent:** **** Sep. 7, 2021**

(54) **VEGETABLE SHREDDER**

FOREIGN PATENT DOCUMENTS

(71) Applicant: **Zhejiang Fullstar Houseware Co., Ltd.**, Taizhou (CN)

DE 202013105877 U1 * 1/2014 B26D 7/0608

(72) Inventor: **Congqiang Lu**, Taizhou (CN)

OTHER PUBLICATIONS

(**) Term: **15 Years**

Amazon.com, Fullstar Mandoline Slicer Spiralizer Vegetable Slicer, pp. 1-8 , date first available Aug. 26, 2019 (Year: 2019).*
Amazon.com, Progressive International Grate, Slice and Store Set, pp. 1-5, date first available May 1, 2019 (Year: 2019).*

(21) Appl. No.: **29/744,210**

* cited by examiner

(22) Filed: **Jul. 28, 2020**

(51) **LOC (13) Cl.** **07-04**

Primary Examiner — Terry A Wallace

(52) **U.S. Cl.**

USPC **D7/678**; D7/673

(58) **Field of Classification Search**

(57) **CLAIM**

USPC D7/678, 672-675
CPC B26D 3/185; B26D 3/26; B26D 3/283;
B26D 2003/285-288; A47J 43/25; A47J
43/255; A47J 42/04; A47J 42/14; A47J
42/34; A47J 42/40

The ornamental design for a vegetable shredder, as shown and described.

See application file for complete search history.

DESCRIPTION

(56) **References Cited**

FIG. 1 is a first perspective view of a vegetable shredder showing my new design;
FIG. 2 is a second perspective view thereof;
FIG. 3 is a front view thereof;
FIG. 4 is a back view thereof;
FIG. 5 is a left side view thereof;
FIG. 6 is a right side view thereof;
FIG. 7 is a top view thereof;
FIG. 8 is a bottom view thereof; and,
FIG. 9 is a perspective view of another state of the vegetable shredder thereof.

U.S. PATENT DOCUMENTS

D167,270 S * 7/1952 Marcus D7/678
2,714,908 A * 8/1955 Carmack A47J 43/25
241/95
4,212,431 A * 7/1980 Doyel A47J 43/25
241/100
D354,886 S * 1/1995 Diefenbach D7/678
5,745,999 A * 5/1998 Zirkiev A47J 43/25
30/278
D512,609 S * 12/2005 Kaposi D7/672
D519,001 S * 4/2006 So D7/678
D632,139 S * 2/2011 Repac D7/673
D708,917 S * 7/2014 Wong D7/672
D776,495 S * 1/2017 Repac D7/672
D776,989 S * 1/2017 Wong D7/678

The broken lines shown in the drawings depict portions of the vegetable shredder in which the design is embodied that form no part of the claimed design.

1 Claim, 9 Drawing Sheets

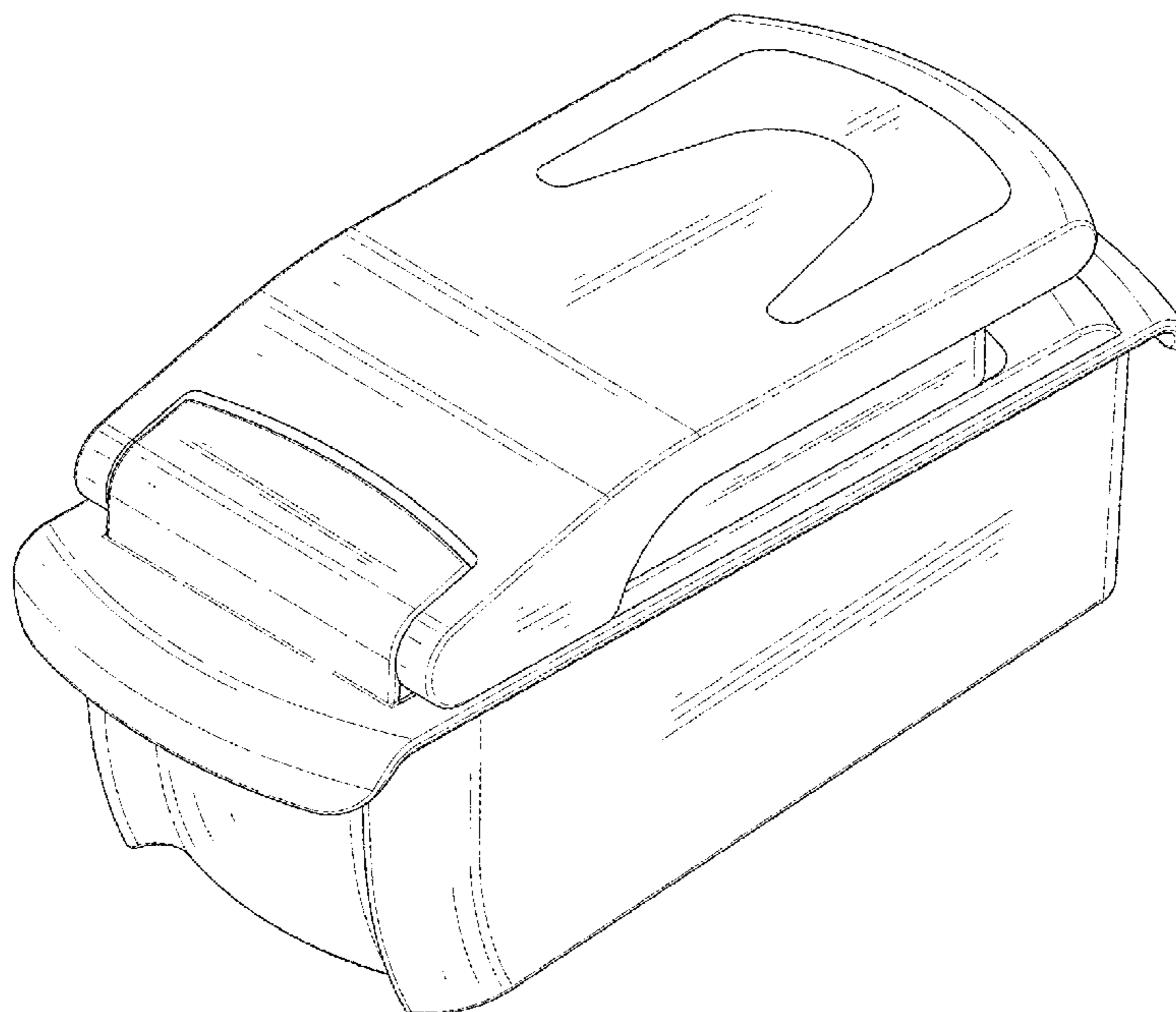

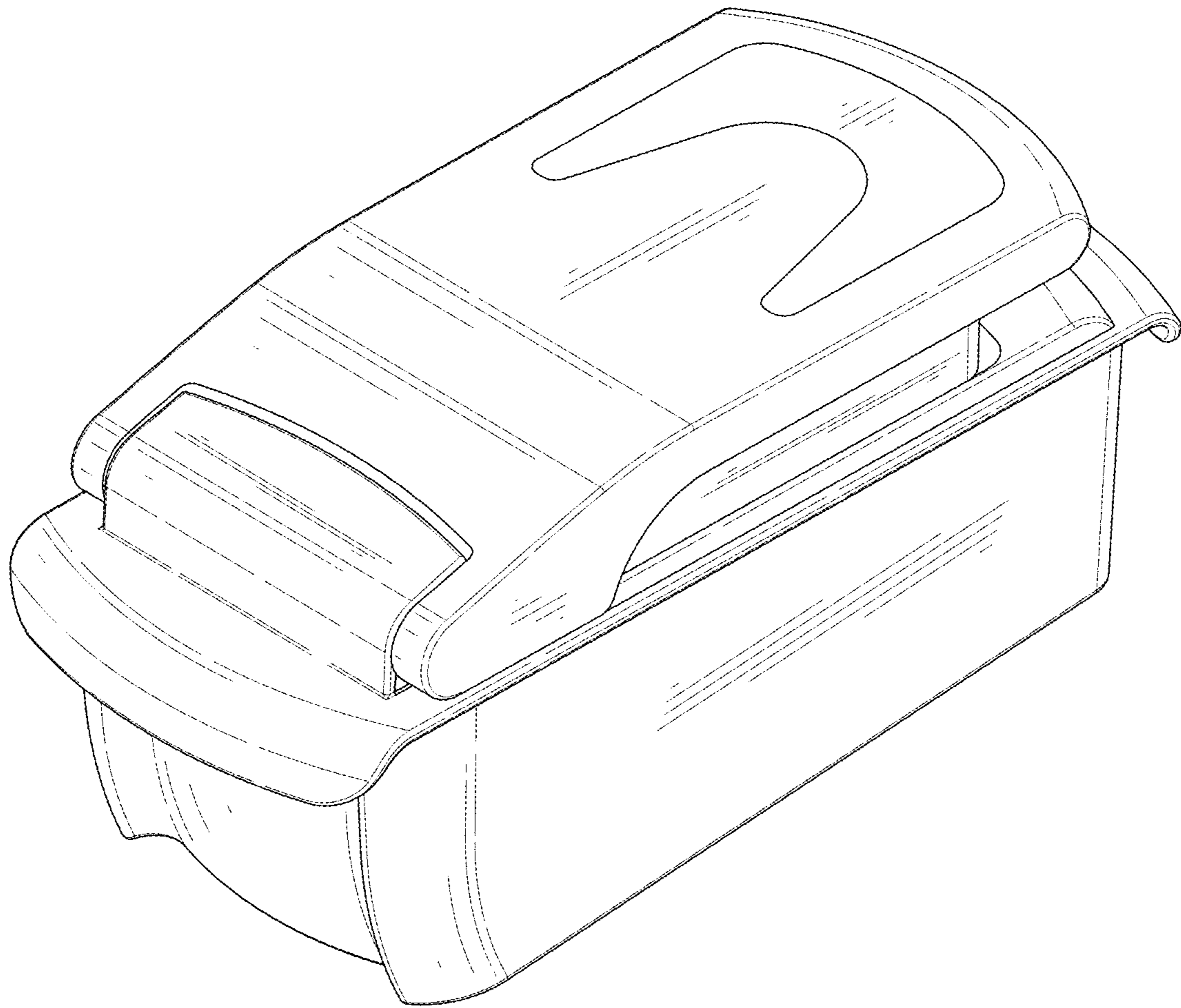

FIG. 1

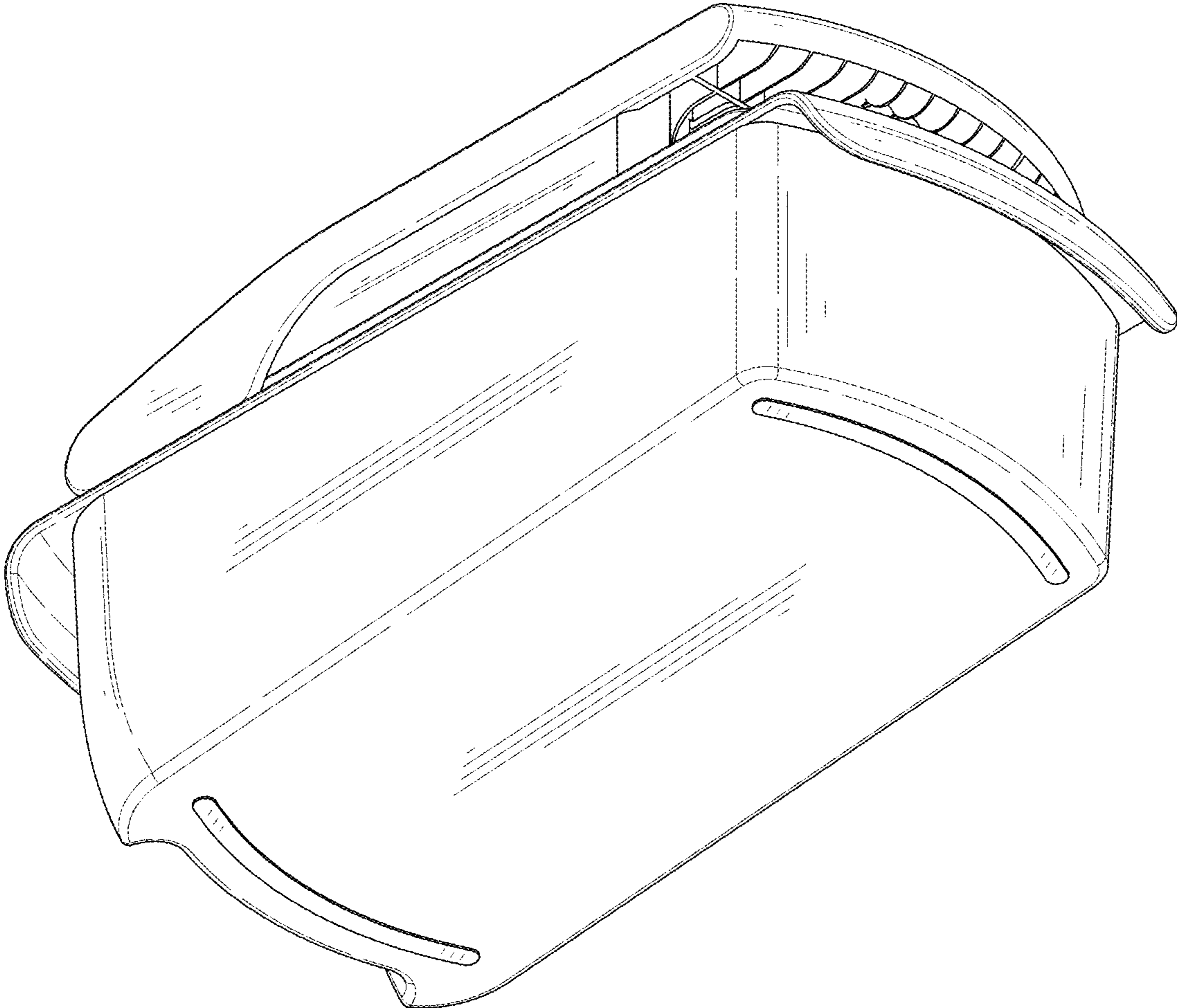

FIG. 2

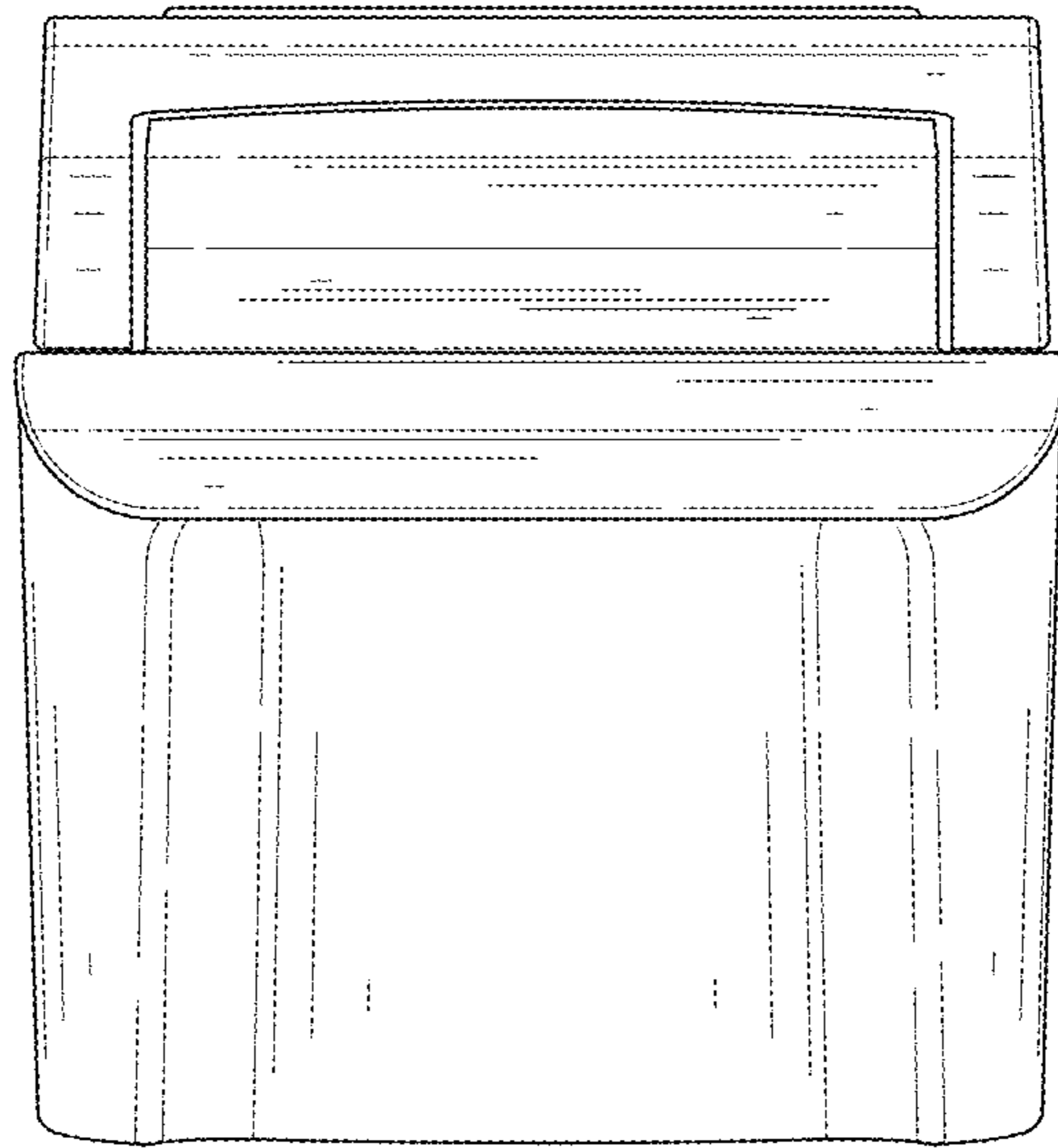

FIG. 3

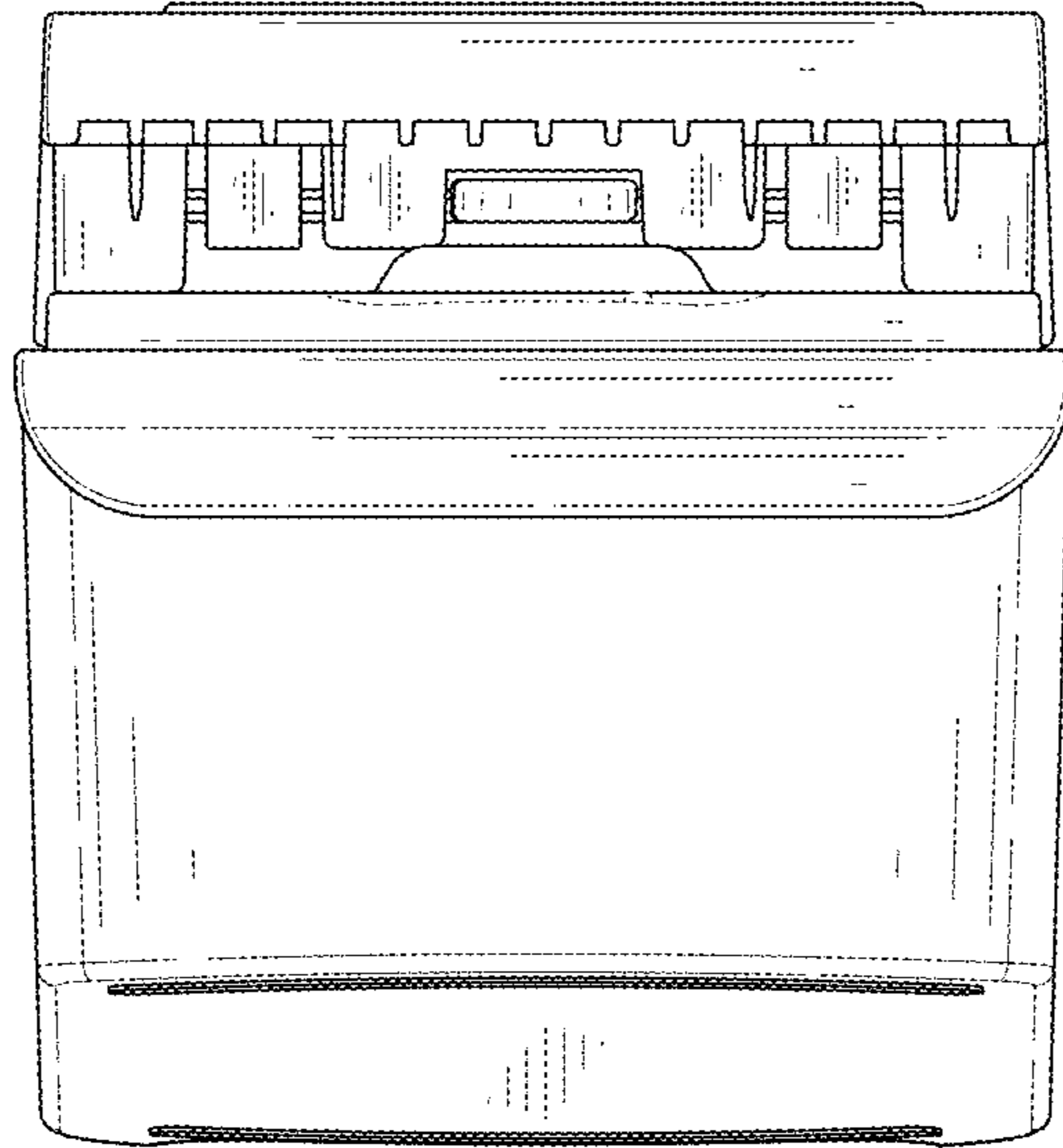

FIG. 4

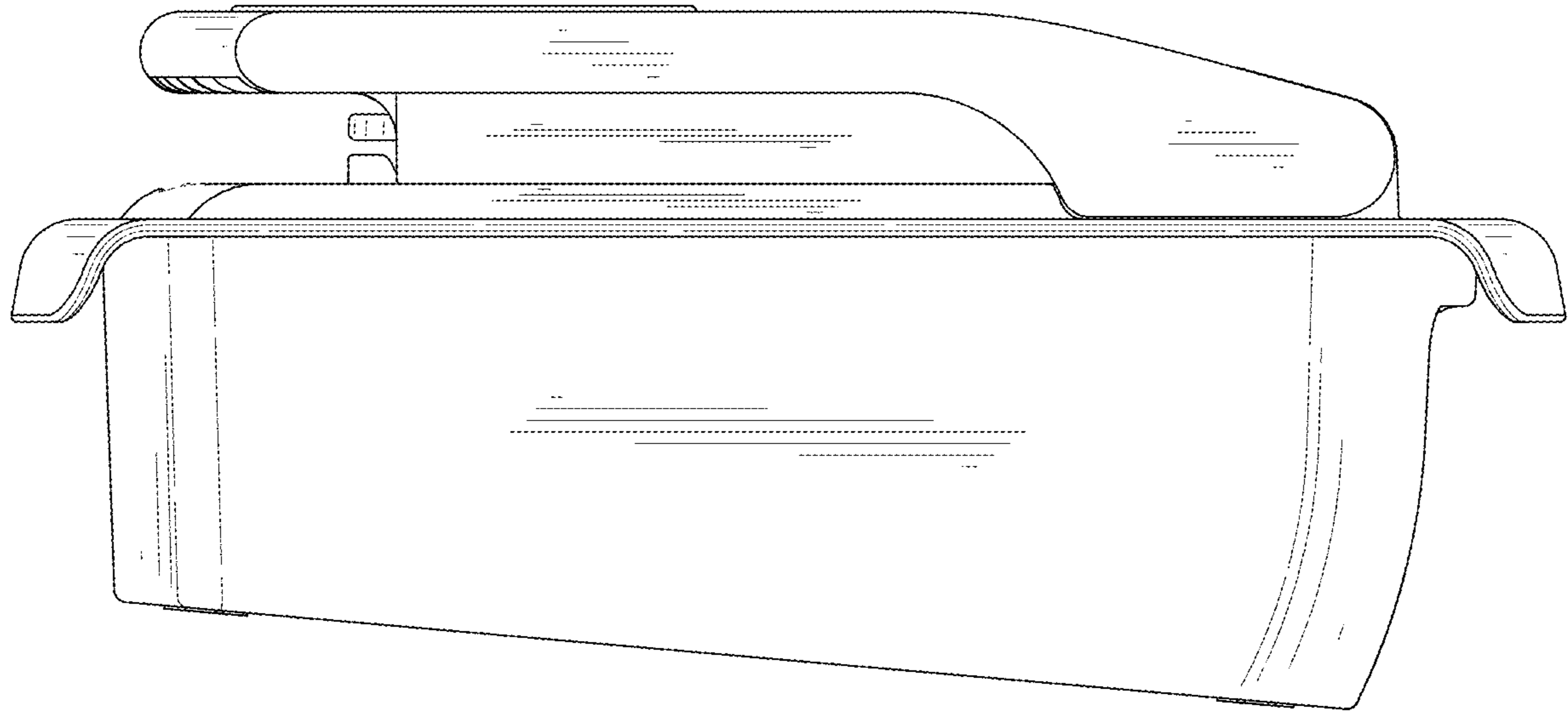

FIG. 5

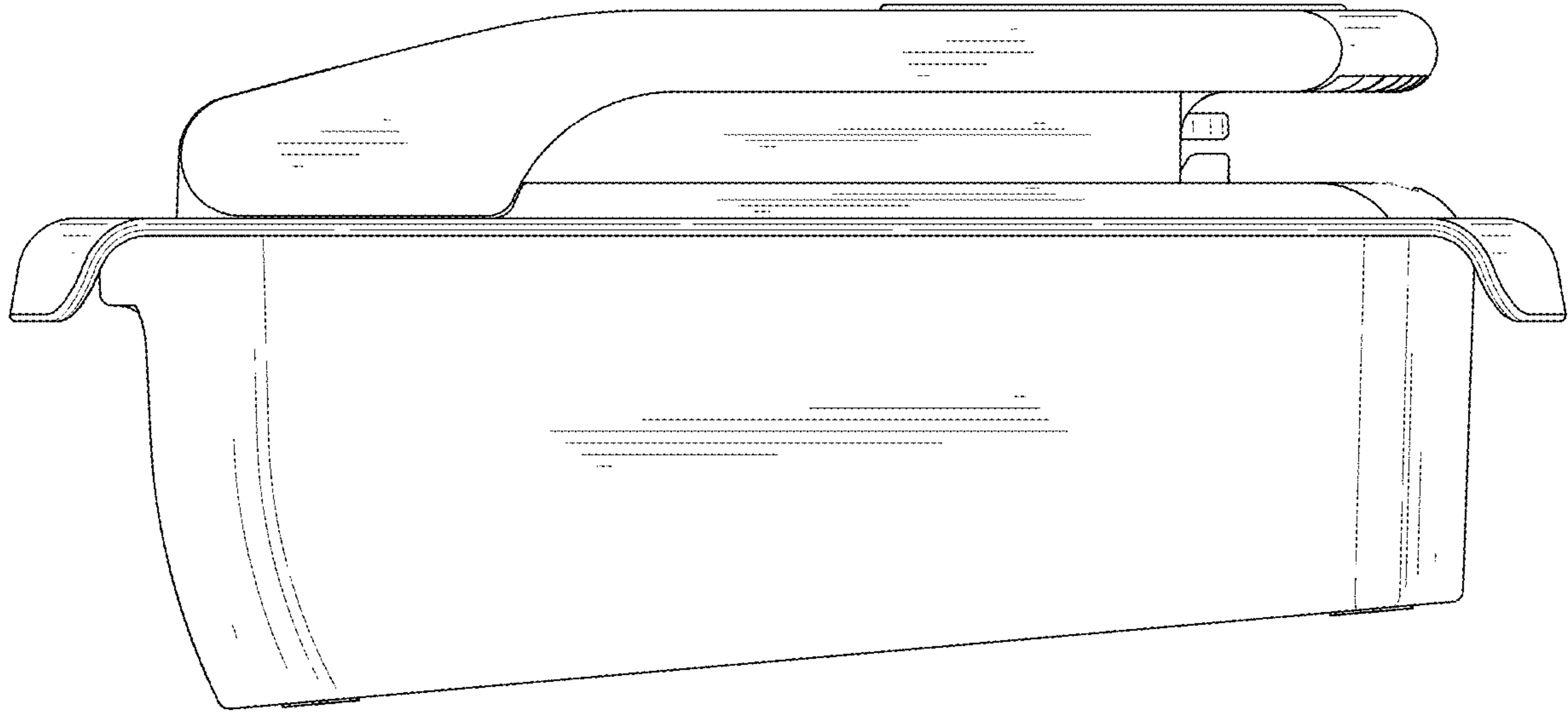

FIG. 6

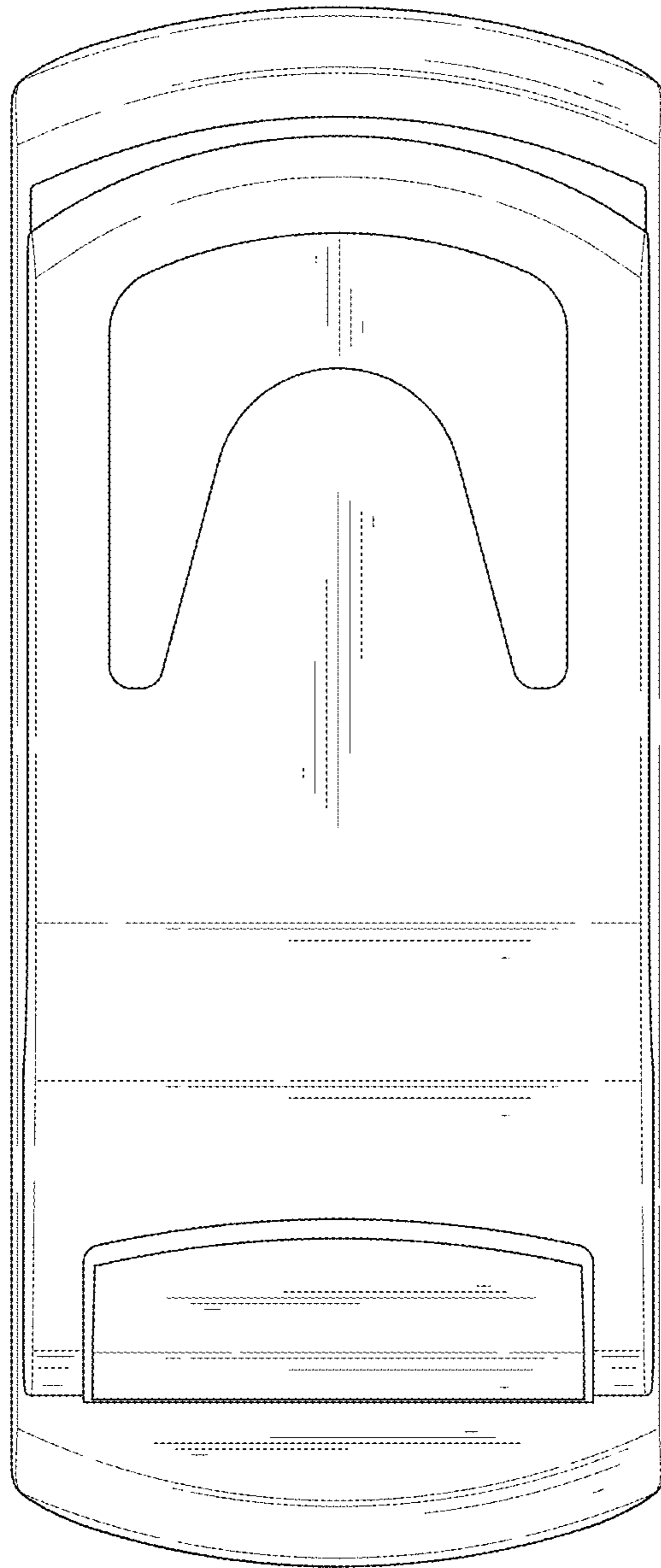

FIG. 7

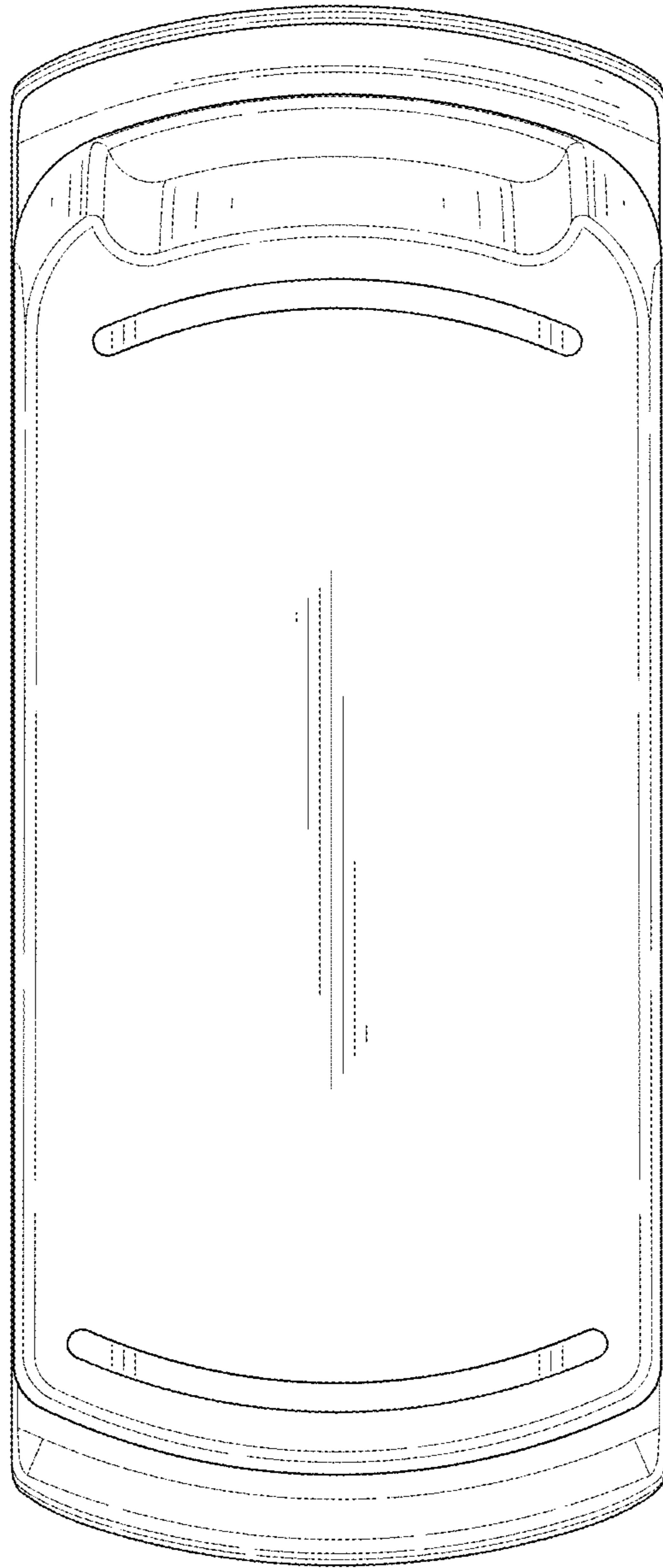

FIG. 8

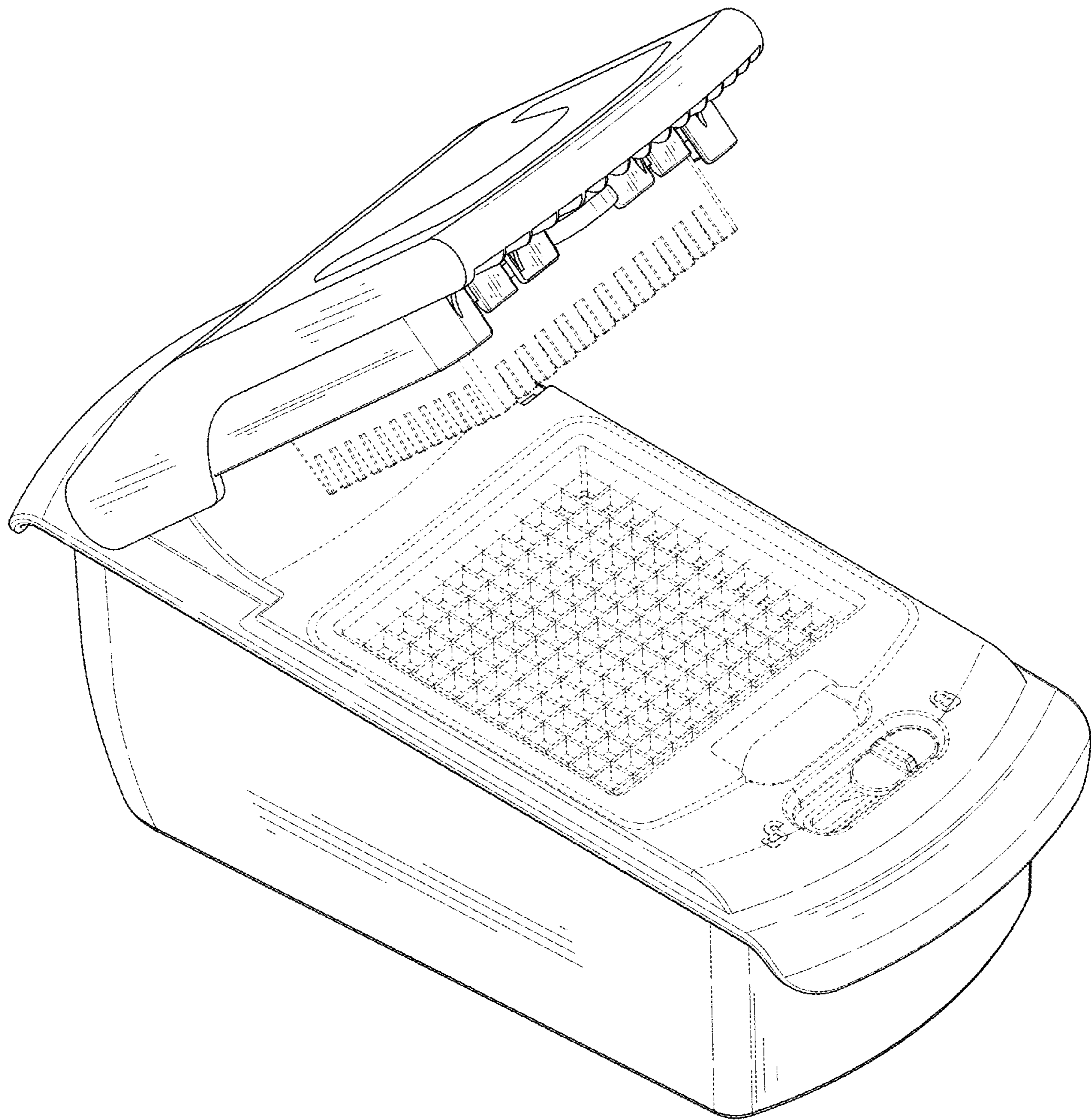

FIG. 9