



US00D929752S

(12) **United States Design Patent** (10) **Patent No.:** **US D929,752 S**
Losness et al. (45) **Date of Patent:** **** Sep. 7, 2021**

(54) **HANGER**

(71) Applicant: **TARGET BRANDS, INC.**,
Minneapolis, MN (US)

(72) Inventors: **Laurie Losness**, Coon Rapids, MN
(US); **Terrence J. Hornsby, Jr.**,
Minneapolis, MN (US); **Jeremy A.
Clark**, Minneapolis, MN (US)

(73) Assignee: **TARGET BRANDS, INC.**,
Minneapolis, MN (US)

(**) Term: **15 Years**

(21) Appl. No.: **29/733,558**

(22) Filed: **May 4, 2020**

(51) **LOC (13) Cl.** **06-08**

(52) **U.S. Cl.**
USPC **D6/319**

(58) **Field of Classification Search**
USPC **D6/315-328**

(Continued)

(56) **References Cited**

U.S. PATENT DOCUMENTS

890,023 A 6/1908 Cazier et al.
1,758,807 A 5/1930 Serposs

(Continued)

FOREIGN PATENT DOCUMENTS

EP 1512352 B1 8/2013

OTHER PUBLICATIONS

“Velvet Flocked Hanger”, printed from www.dhgate.com/product/flocked-hanger-with-good-quality-druable/138480211.html, publicly available at least as early as Jan. 18, 2017 (3 pages).

(Continued)

Primary Examiner — Lauren R Calve
(74) *Attorney, Agent, or Firm* — JoAnn M. Seaton;
Griffiths & Seaton PLLC

(57) **CLAIM**

The ornamental design for a hanger, as shown and described.

DESCRIPTION

FIG. 1 is a front, top perspective view of a hanger showing an embodiment of our new design; FIG. 2 is a rear, top perspective view thereof; FIG. 3 is a front view thereof; FIG. 4 is a rear view thereof; FIG. 5 is a left side view thereof; FIG. 6 is a right side view thereof; FIG. 7 is a top view thereof; and FIG. 8 is a bottom view thereof. FIG. 9 is a front, top perspective view of a hanger showing a second embodiment of our new design; FIG. 10 is a rear, top perspective view thereof; FIG. 11 is a front view thereof; FIG. 12 is a rear view thereof; FIG. 13 is a left side view thereof; FIG. 14 is a right side view thereof; FIG. 15 is a top view thereof; and FIG. 16 is a bottom view thereof. FIG. 17 is a front, top perspective view of a hanger showing a third embodiment of our new design; FIG. 18 is a rear, top perspective view thereof; FIG. 19 is a front view thereof; FIG. 20 is a rear view thereof; FIG. 21 is a left side view thereof; FIG. 22 is a right side view thereof; FIG. 23 is a top view thereof; and, FIG. 24 is a bottom view thereof.

The features shown in broken lines are portions of the hanger forming no part of the claimed design. The features shown in long dash-short dash bolded broken lines indicate the bounds of the claimed design and otherwise form no part of the claimed design.

1 Claim, 18 Drawing Sheets

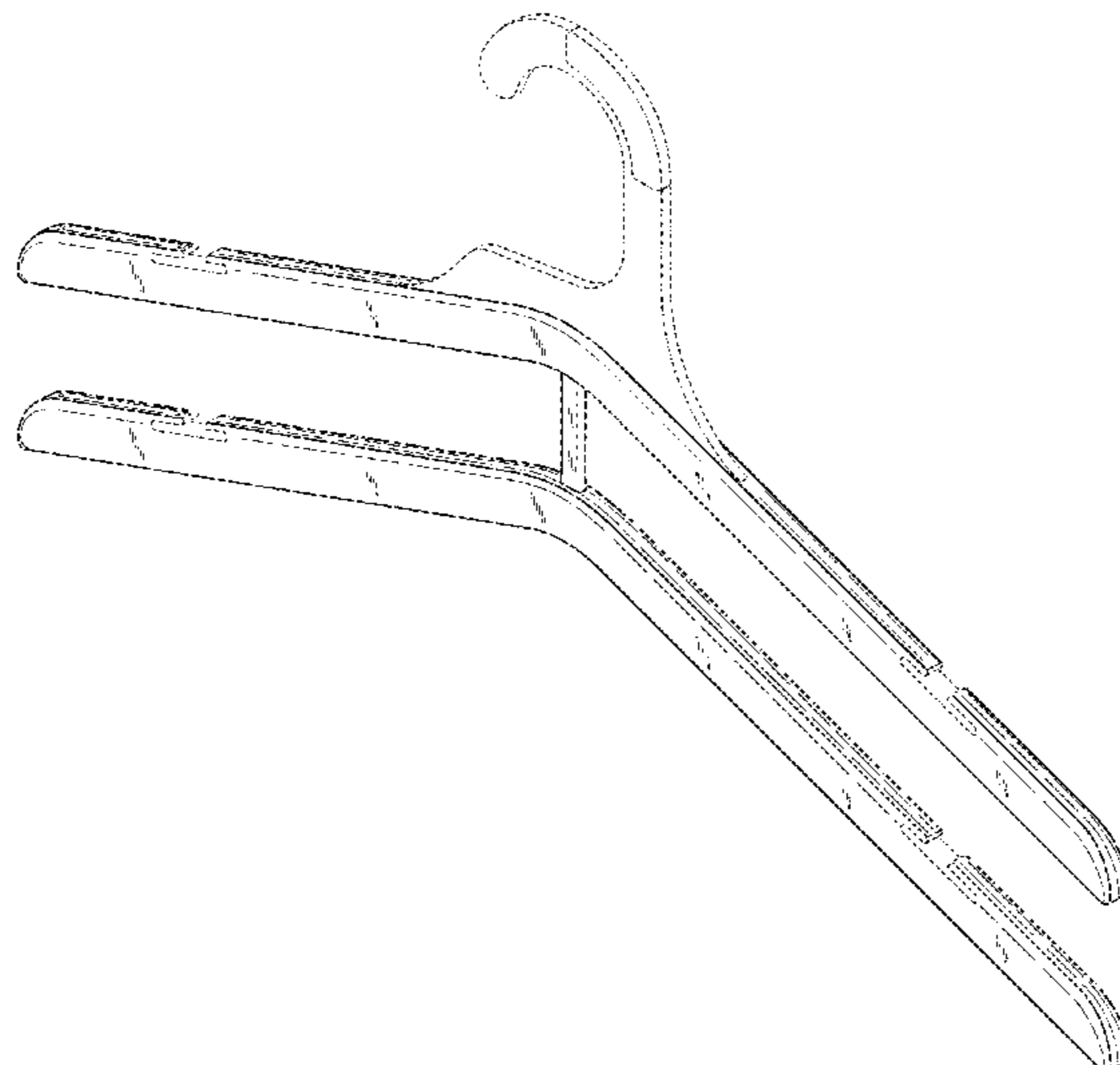

(58) **Field of Classification Search**
 CPC A47G 25/32; A47G 25/26; A47G 25/28;
 A47G 25/485; A47G 25/487; A47G
 25/20; A47G 25/481; A47G 25/442;
 A47G 25/24; A47G 25/48; A47G 25/486;
 A47G 25/36; A47G 25/1407; A47G
 25/30; A47G 25/14; A47G 25/743; A47G
 25/1457

See application file for complete search history.

(56) **References Cited**

U.S. PATENT DOCUMENTS

2,171,680	A	9/1939	Baugh
2,419,723	A	4/1947	Mack, Sr.
2,723,787	A	11/1955	Brandsdorf
2,835,422	A	5/1958	Stuard
3,085,724	A	4/1963	Wilde
D195,445	S	6/1963	Warmath
D196,214	S	9/1963	Warmath, III
3,209,966	A	10/1965	Wach
D206,199	S	11/1966	Zuckerman
3,307,753	A	3/1967	Levine et al.
3,559,852	A	2/1971	Green
3,731,857	A	5/1973	Haggar
D264,912	S	6/1982	Bliss et al.
D265,156	S	6/1982	Bisk et al.
D271,552	S	11/1983	Samuels
4,438,874	A	3/1984	Zuckerman et al.
4,623,079	A	11/1986	Tendrup et al.
4,828,155	A	5/1989	Louw
D302,214	S	7/1989	Wilson
D302,359	S	* 7/1989	Blom D6/324
D303,325	S	9/1989	Marshall
4,871,098	A	10/1989	Bredeweg et al.
D305,484	S	1/1990	Fildan
4,895,283	A	1/1990	Evangelist et al.
D309,221	S	7/1990	Blom et al.
5,029,739	A	7/1991	Blanchard et al.
5,065,916	A	11/1991	Fildan
5,069,373	A	12/1991	Kolton et al.
5,071,045	A	12/1991	Hollis
5,074,445	A	12/1991	Chen
5,083,691	A	1/1992	Handrick
D324,313	S	3/1992	Kolton et al.
D327,579	S	7/1992	Fildan
D327,580	S	7/1992	Fildan
D327,581	S	7/1992	Fildan
5,127,559	A	7/1992	Freer et al.
5,129,557	A	7/1992	Kolton et al.
D329,754	S	9/1992	Gouldson et al.
D329,755	S	9/1992	Gouldson
D335,581	S	5/1993	Gouldson
5,236,109	A	8/1993	Zuckerman
D340,138	S	10/1993	Gouldson
D348,987	S	7/1994	Gouldson et al.
D350,236	S	9/1994	Gouldson et al.
5,361,949	A	11/1994	Petrou
D353,945	S	1/1995	Louw
D368,376	S	4/1996	Gouldson et al.
D371,246	S	7/1996	Gouldson et al.
5,573,151	A	11/1996	Fildan
5,632,423	A	5/1997	Louw
D381,814	S	8/1997	Louw
D387,912	S	12/1997	Fildan
D388,620	S	1/1998	Gouldson et al.
D388,964	S	1/1998	Gouldson
D390,015	S	2/1998	Gouldson
D392,113	S	3/1998	Gouldson
5,806,728	A	9/1998	Forsstrom et al.
D413,446	S	9/1999	Gouldson
D414,044	S	9/1999	Choi et al.
D414,946	S	10/1999	Gouldson
6,065,652	A	5/2000	Dooling-Sherman
D426,389	S	6/2000	Dooling
6,070,772	A	6/2000	Bond

6,079,598	A	6/2000	Tsai
6,105,835	A	8/2000	Hatakeyama
6,142,347	A	11/2000	Kolton et al.
6,158,635	A	12/2000	Batts
D435,973	S	1/2001	Gouldson
6,170,679	B1	1/2001	Frye et al.
6,173,872	B1	1/2001	Cohen
6,196,430	B1	3/2001	Gouldson
D440,777	S	4/2001	Giustini
6,209,763	B1	4/2001	Rahmey
D443,424	S	6/2001	Eiley et al.
6,250,523	B1	6/2001	Louw
6,286,735	B1	9/2001	Zuckerman
6,338,426	B1	1/2002	Okiyama
D453,423	S	2/2002	Goldman et al.
6,357,638	B2	3/2002	Gouldson
6,435,387	B1	8/2002	Gouldson et al.
6,457,615	B1	10/2002	Lam
6,467,658	B1	10/2002	Olk et al.
6,467,659	B2	10/2002	Gouldson
6,499,634	B2	12/2002	Olk et al.
6,516,980	B1	2/2003	Goldman
6,588,634	B2	7/2003	Gouldson et al.
6,688,503	B2	2/2004	Viazanko et al.
6,715,650	B2	4/2004	Gouldson
D498,936	S	11/2004	Gouldson
D499,257	S	12/2004	Schutz et al.
D500,412	S	1/2005	Gouldson
D502,606	S	3/2005	Gouldson
6,892,910	B2	5/2005	Capuano et al.
D507,419	S	7/2005	Gouldson
D519,287	S	4/2006	Gouldson
7,118,014	B2	10/2006	Ali et al.
7,156,271	B2	1/2007	Louw
D559,562	S	1/2008	Jones
D560,373	S	1/2008	Gouldson
7,398,902	B1	7/2008	Sutton
7,464,841	B1	12/2008	Hansen et al.
D598,206	S	8/2009	Gouldson
D606,764	S	12/2009	Warren
D606,765	S	12/2009	Warren
D606,766	S	12/2009	Warren
D606,767	S	12/2009	Warren
D607,216	S	1/2010	Niccol
D607,217	S	1/2010	Warren
D607,218	S	1/2010	Warren
D623,867	S	9/2010	Fort et al.
D628,818	S	12/2010	Warren
D628,820	S	12/2010	Warren
D628,821	S	12/2010	Warren
D628,822	S	12/2010	Warren
7,896,204	B2	3/2011	Gouldson
7,938,300	B2	5/2011	Diamond et al.
7,975,885	B2	7/2011	Chan
7,980,434	B2	7/2011	Gouldson
D646,064	S	10/2011	Jones
D653,042	S	1/2012	Gouldson
8,267,287	B2	9/2012	Gouldson
8,302,826	B2	11/2012	Gouldson
D688,471	S	8/2013	Cohen
D711,659	S	8/2014	Gouldson
D712,166	S	9/2014	Gouldson
D716,062	S	10/2014	Gouldson
8,991,666	B2	3/2015	Mazyck
9,027,804	B2	5/2015	Barre et al.
9,282,839	B2	3/2016	Rakhimimov et al.
D759,392	S	6/2016	Yau
D761,028	S	7/2016	Choy
9,386,873	B2	7/2016	Gouldson
9,510,702	B2	12/2016	Yau
D815,845	S	4/2018	Clark et al.
D816,351	S	5/2018	Clark et al.
D826,582	S	8/2018	Clark et al.
D831,987	S	10/2018	Clark et al.
D832,600	S	11/2018	Clark et al.
D843,740	S	3/2019	Peterson et al.
D843,741	S	3/2019	Clark et al.
D846,893	S	4/2019	Clark et al.
D850,126	S	6/2019	Peterson et al.

(56)

References Cited

U.S. PATENT DOCUMENTS

D868,486 S * 12/2019 Kariker D6/326
 D873,035 S * 1/2020 Hong D6/319
 10,631,677 B2* 4/2020 Clark A47G 25/1421
 2001/0015361 A1 8/2001 Gouldson
 2001/0016994 A1 8/2001 Gouldson et al.
 2002/0108975 A1 8/2002 Hunt et al.
 2002/0113100 A1 8/2002 Gouldson
 2003/0015558 A1 1/2003 Gouldson et al.
 2003/0141374 A1 7/2003 Matkovich
 2003/0183665 A1 10/2003 Olk et al.
 2004/0173646 A1 9/2004 Louw
 2004/0188475 A1* 9/2004 Gouldson A47G 25/18
 223/85
 2004/0222254 A1 11/2004 Olk et al.
 2004/0256425 A1 12/2004 Barre et al.
 2005/0067447 A1 3/2005 Louw
 2005/0269377 A1 12/2005 Ali et al.
 2007/0246490 A1 10/2007 Gouldson
 2008/0296324 A1 12/2008 Zhao et al.
 2009/0045232 A1 2/2009 Gray
 2009/0078726 A1 3/2009 Boulet et al.
 2010/0019005 A1 1/2010 Gouldson
 2010/0025440 A1 2/2010 Gouldson
 2010/0193553 A1 8/2010 Gouldson
 2010/0252588 A1 10/2010 Gouldson et al.

2011/0057001 A1 3/2011 Louw
 2011/0284597 A1 11/2011 Kaleta et al.
 2015/0060500 A1 3/2015 Yau
 2016/0051072 A1 2/2016 Gouldson
 2017/0208979 A1 7/2017 Zuckerman et al.

OTHER PUBLICATIONS

“Lingerie, Bra & Panty, Swimwear 10" Flexible Plastic Retail Hangers”, printed from www.alibaba.com/product-detail/Lingerie-Bra-Panty-Swimwear-10-Flexible_520783895.html, publicly available at least as early as Dec. 20, 2017 (4 pages).
 “Black Plastic Bra & Swimwear Hangers 27 cm”, printed from www.hangerworld.com/sale/winterplastic/black-plastic-bra-swimwear-hanger-27cm.html, publicly available at least as early as Dec. 20, 2017 (4 pages).
 “Retail Plastic Bra Hangers Wholesale Underwear Hangers For Intimates”, printed from www.alibaba.com/product-detail/Retail-Plastic-Bra-Hangers-Wholesale-Underwear_60554522311.html, publicly available at least as early as Dec. 20, 2017 (7 pages).
 “Smartly Branded SmartWool® Bras—Fixtures Close Up”, printed from www.fixturescloseup.com/2014/03/01/smartly-branded-sports-bras/, publicly available at least as early as Mar. 1, 2014, per <http://web.archive.org> (14 pages).

* cited by examiner

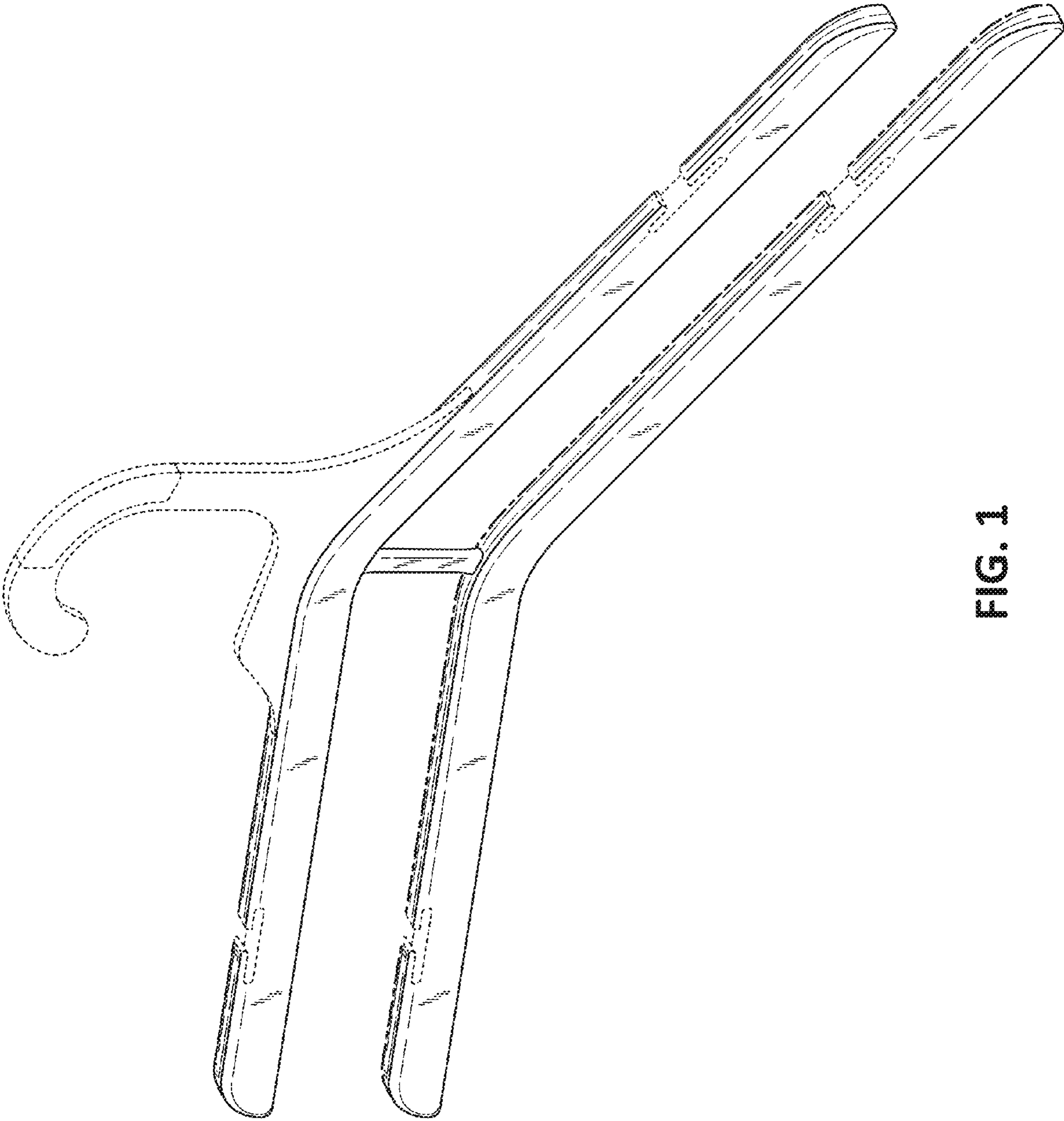

FIG. 1

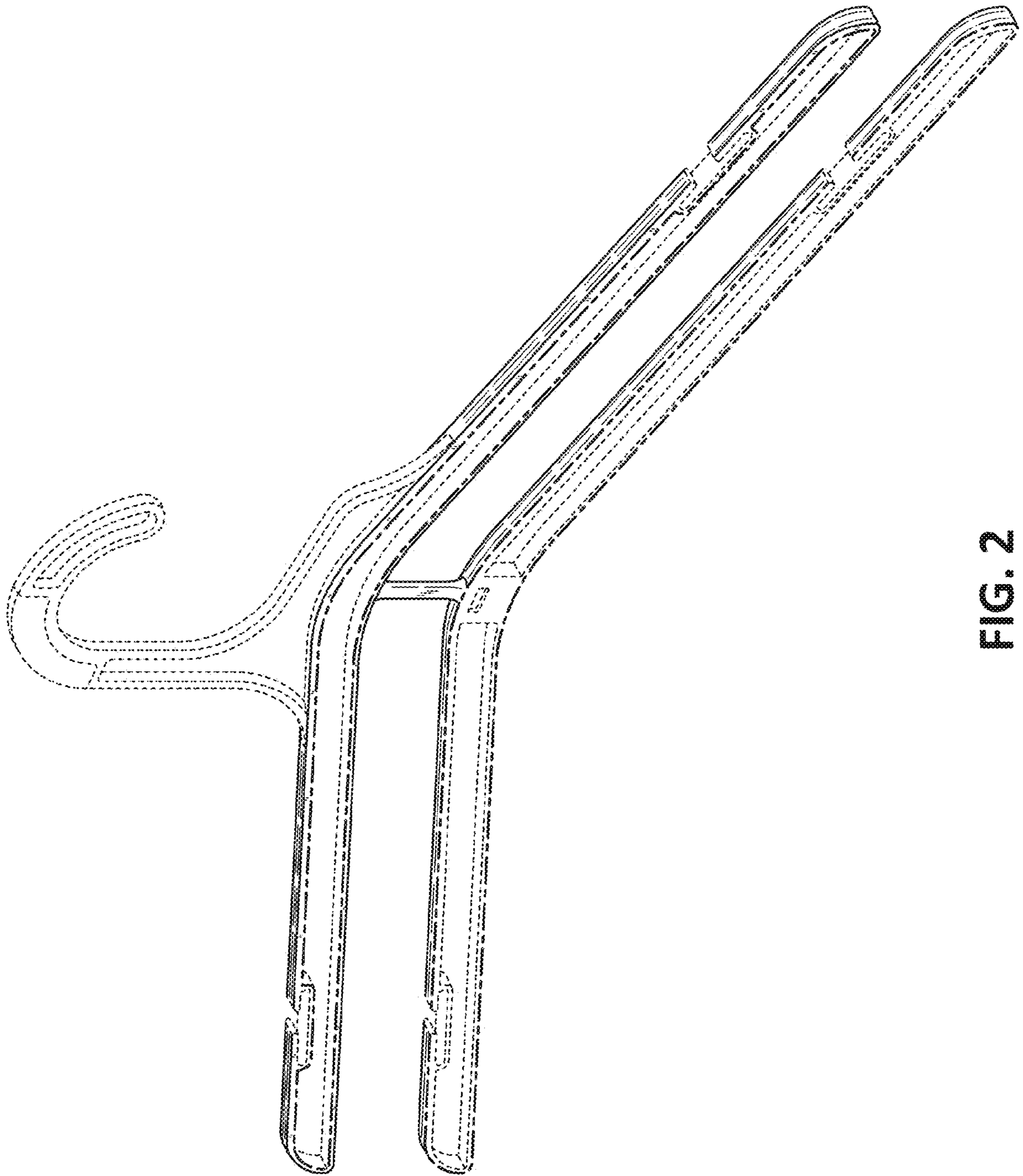

FIG. 2

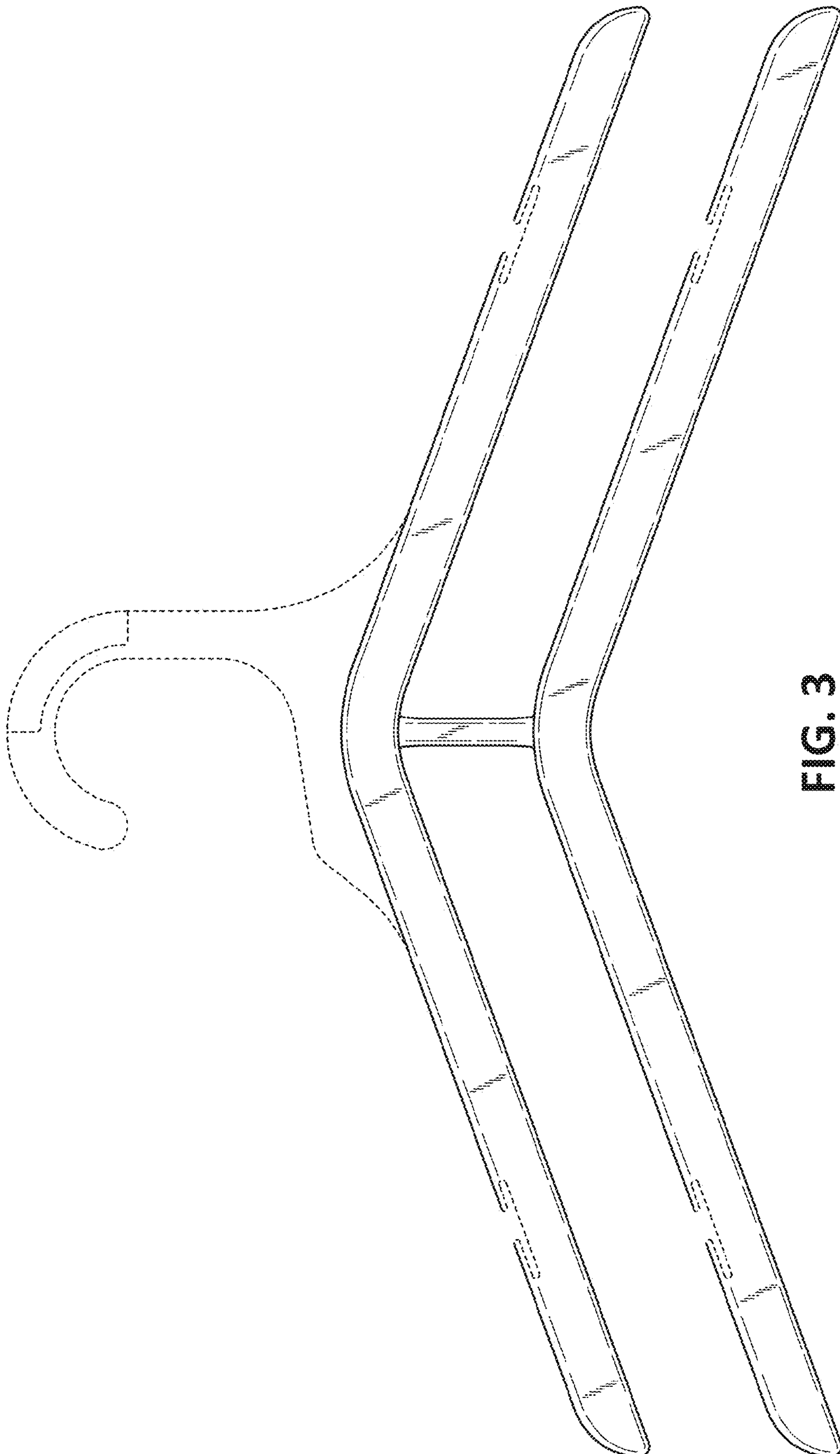

FIG. 3

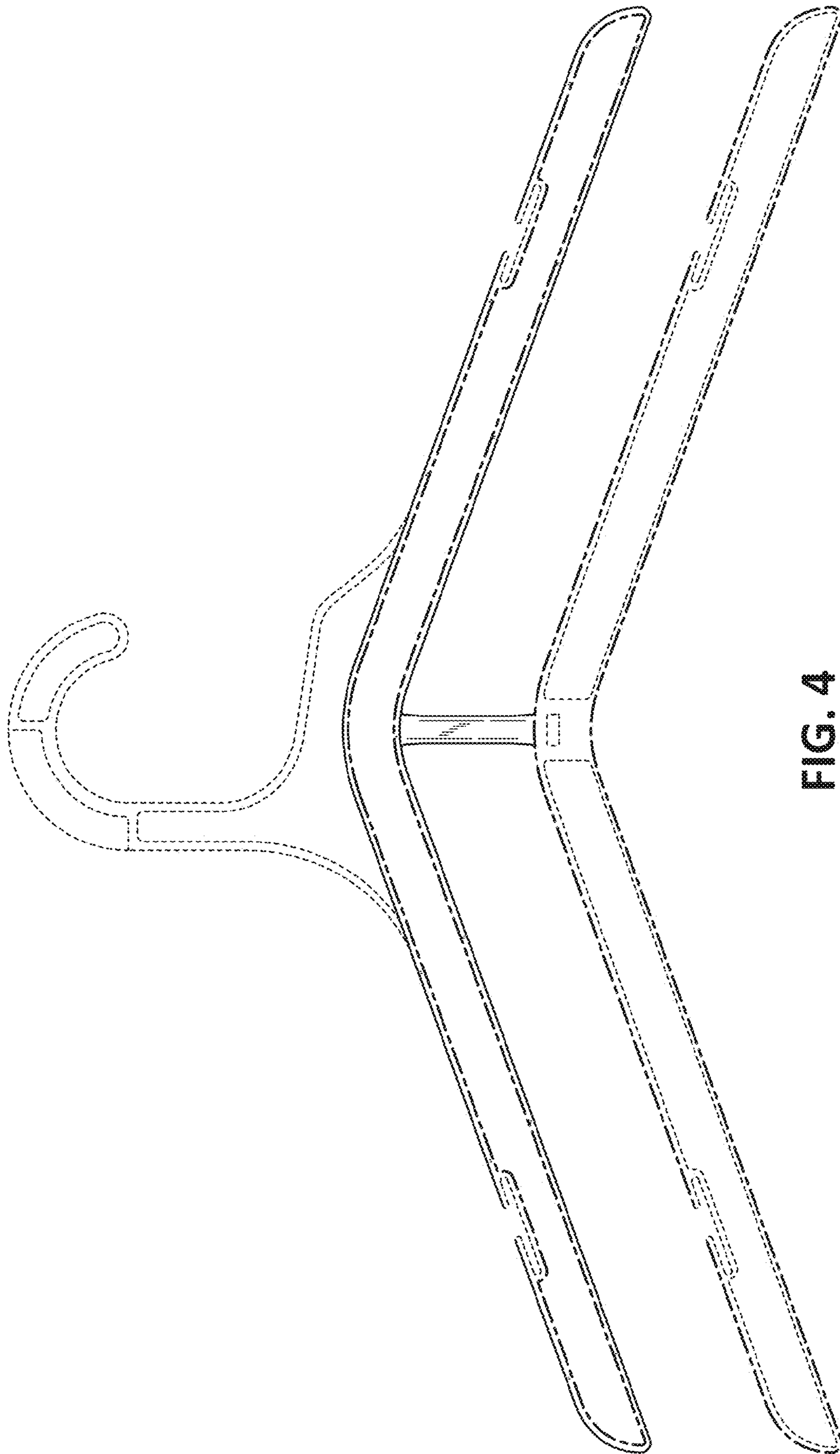

FIG. 4



FIG. 6



FIG. 5

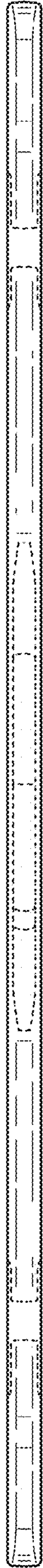

FIG. 7

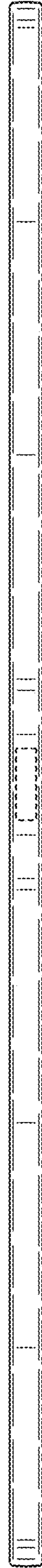

FIG. 8

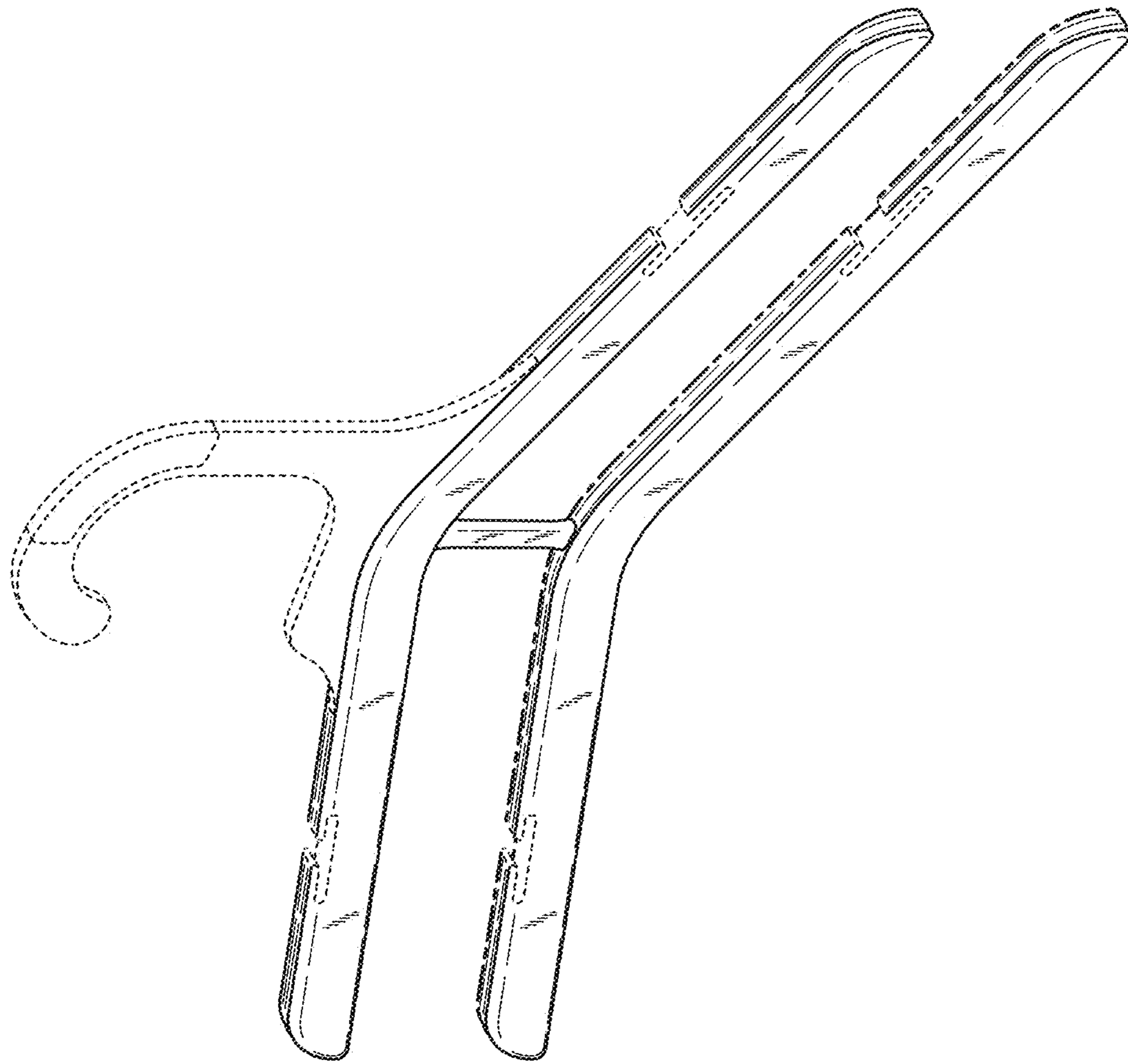

FIG. 9

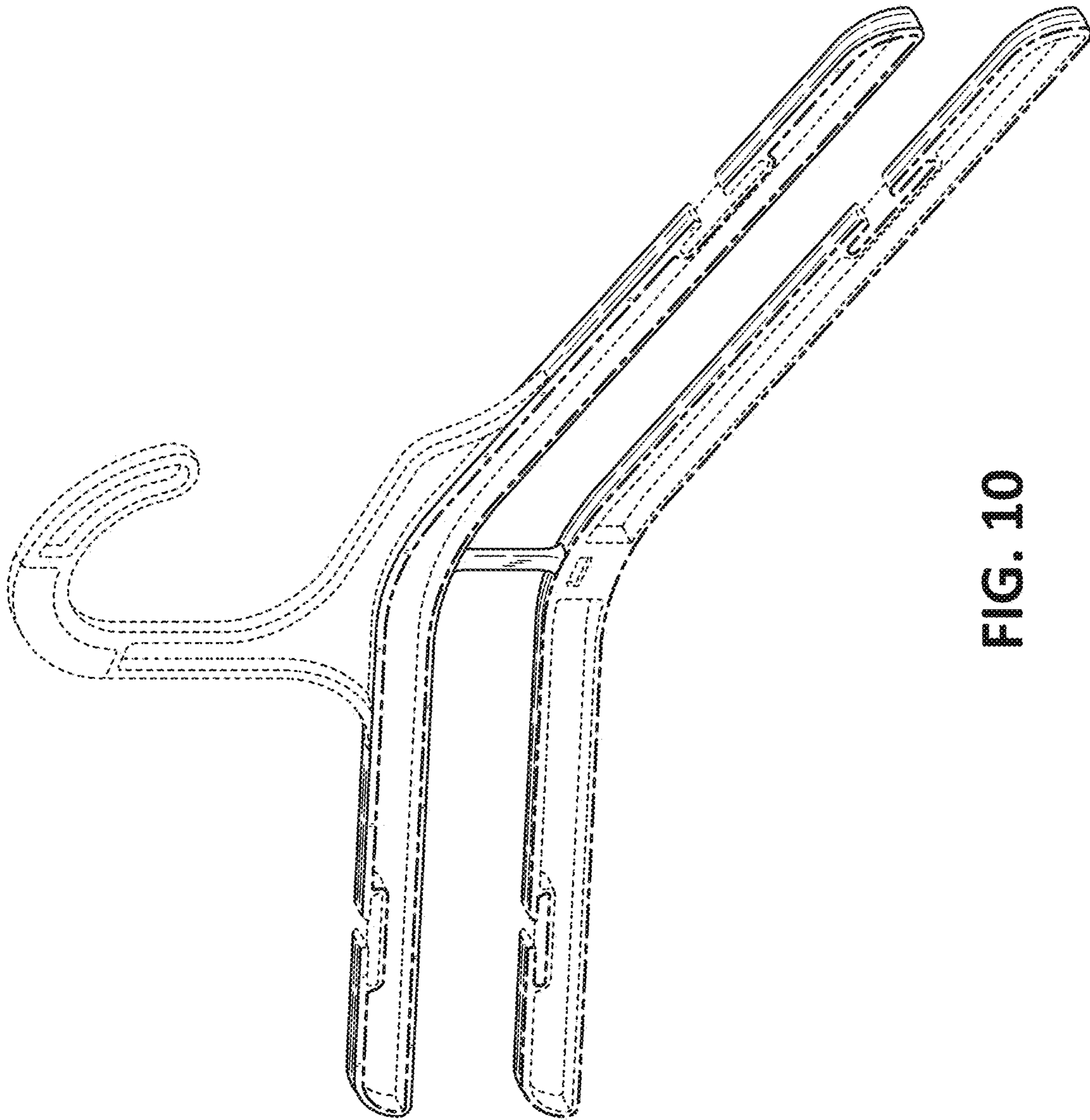

FIG. 10

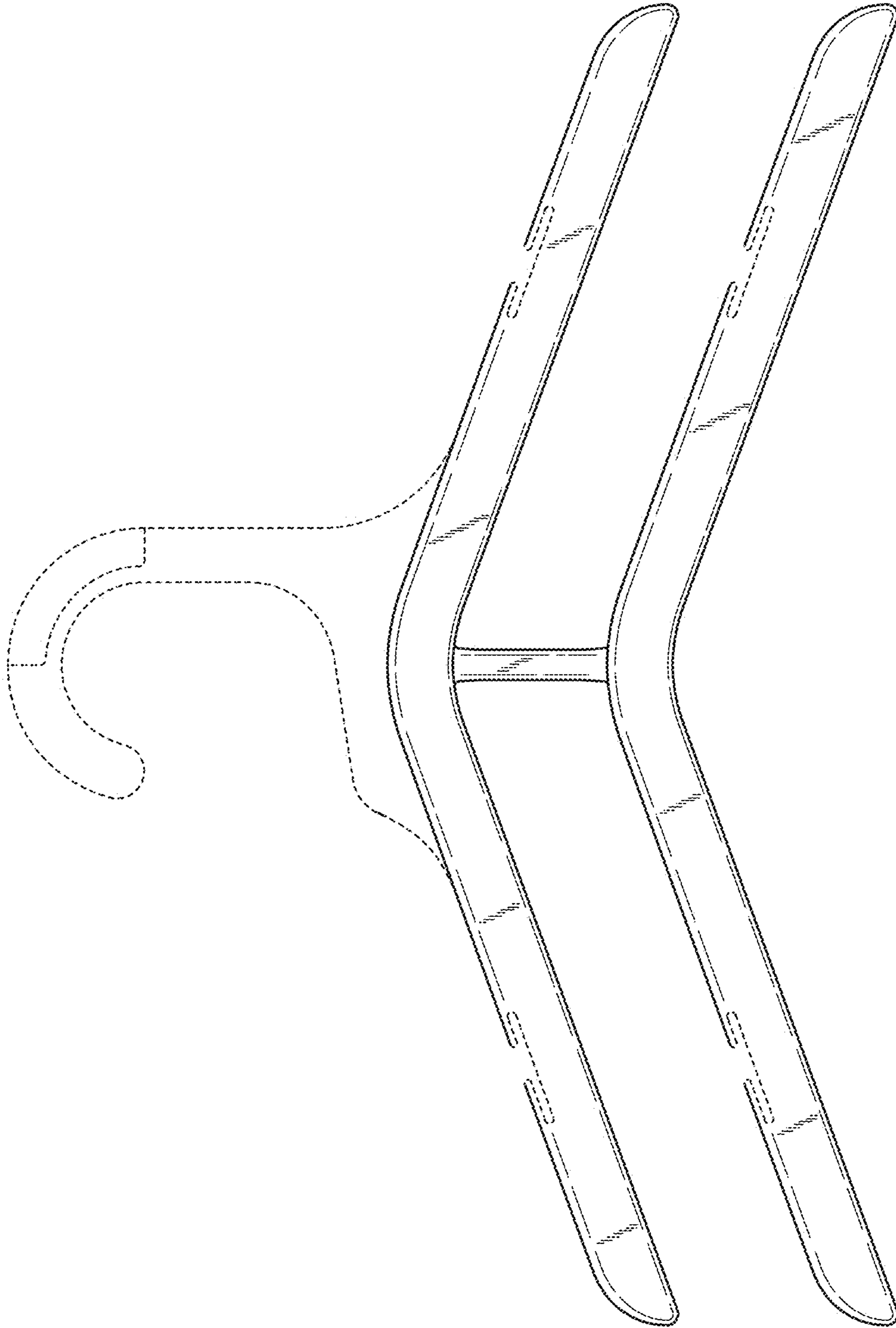

FIG. 11

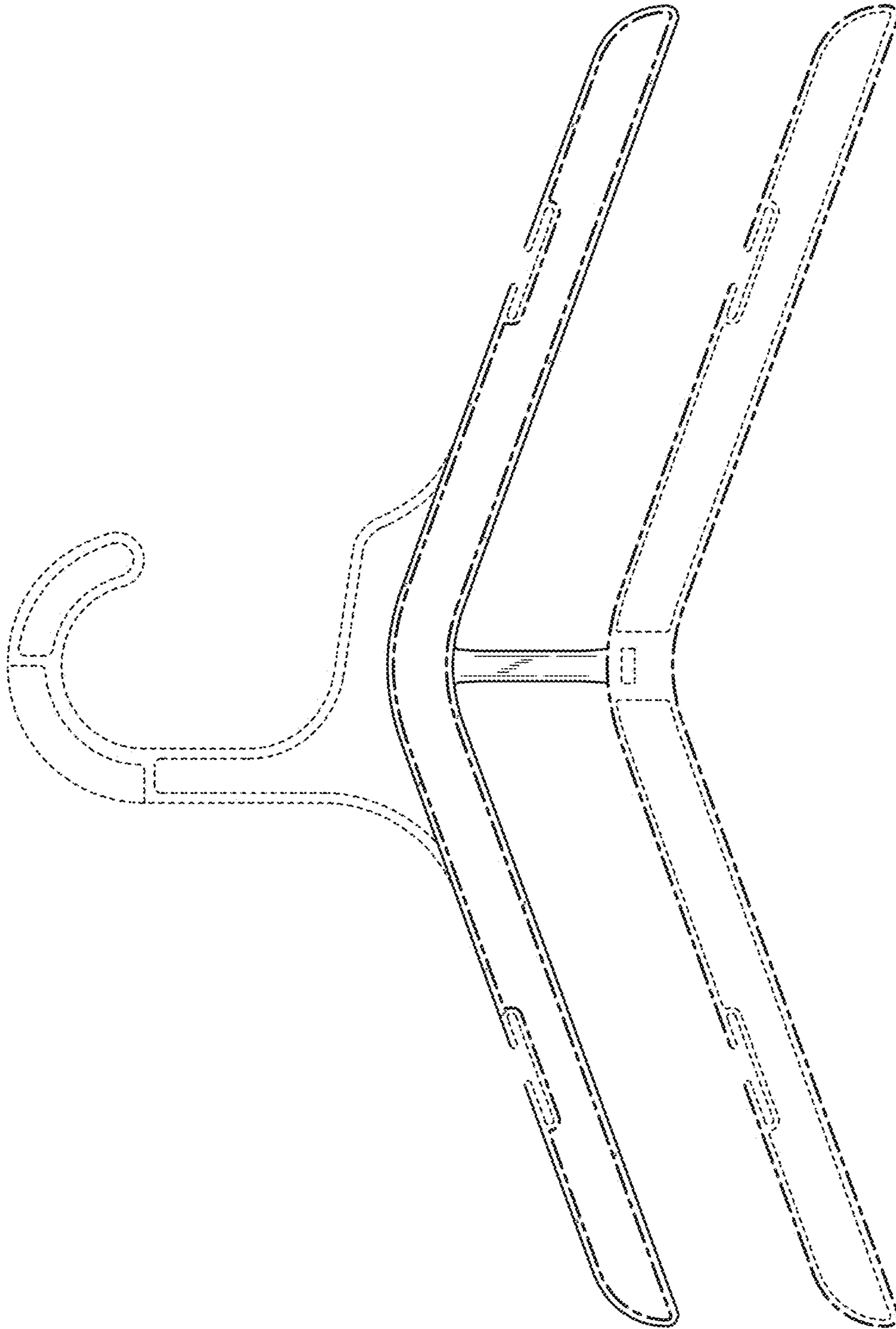

FIG. 12



FIG. 14

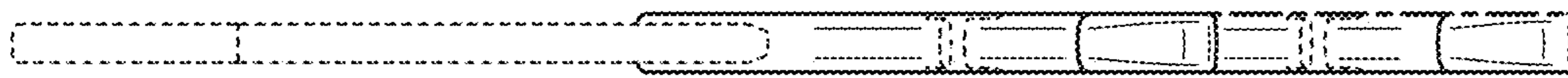

FIG. 13



FIG. 15



FIG. 16

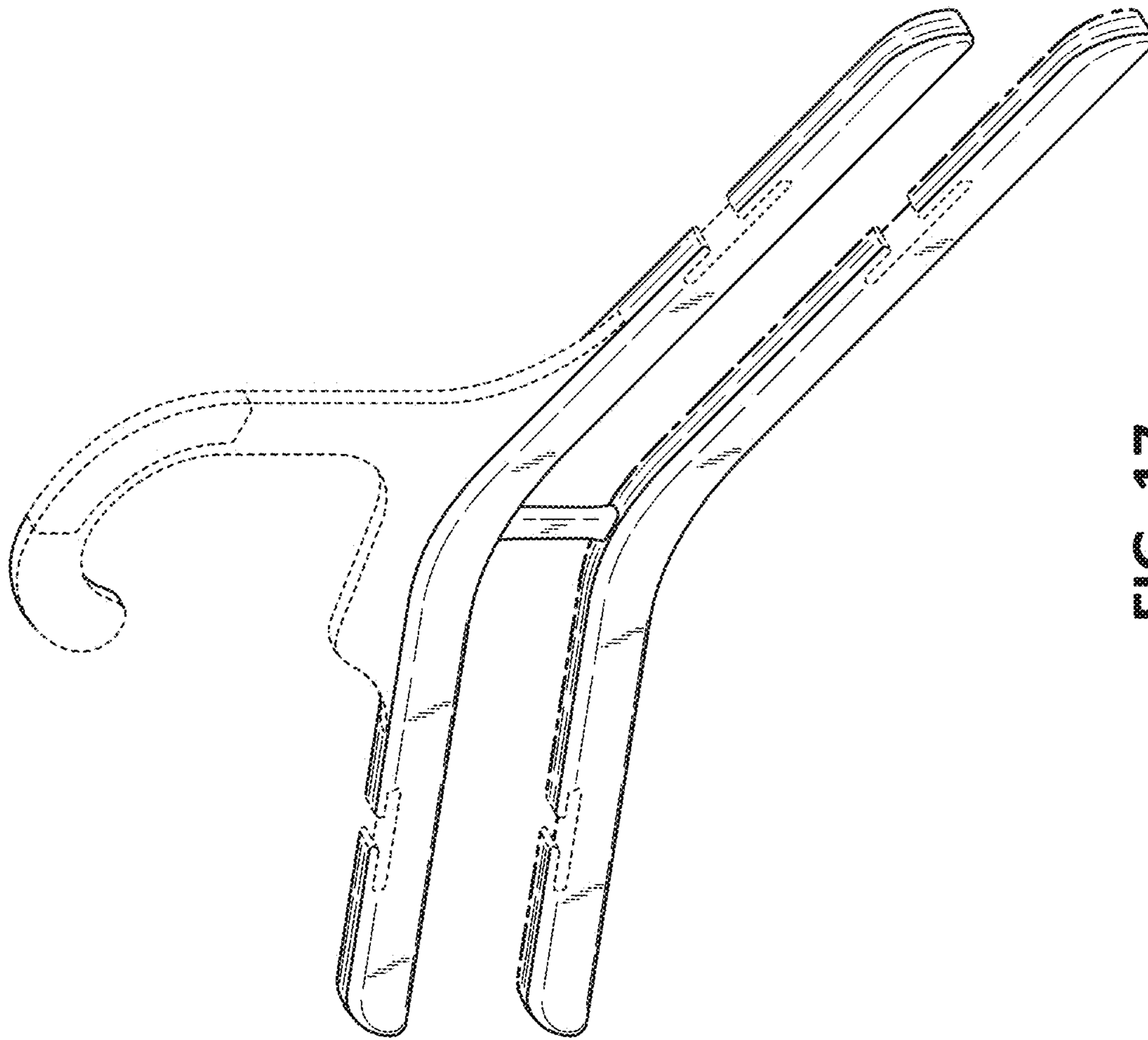

FIG. 17

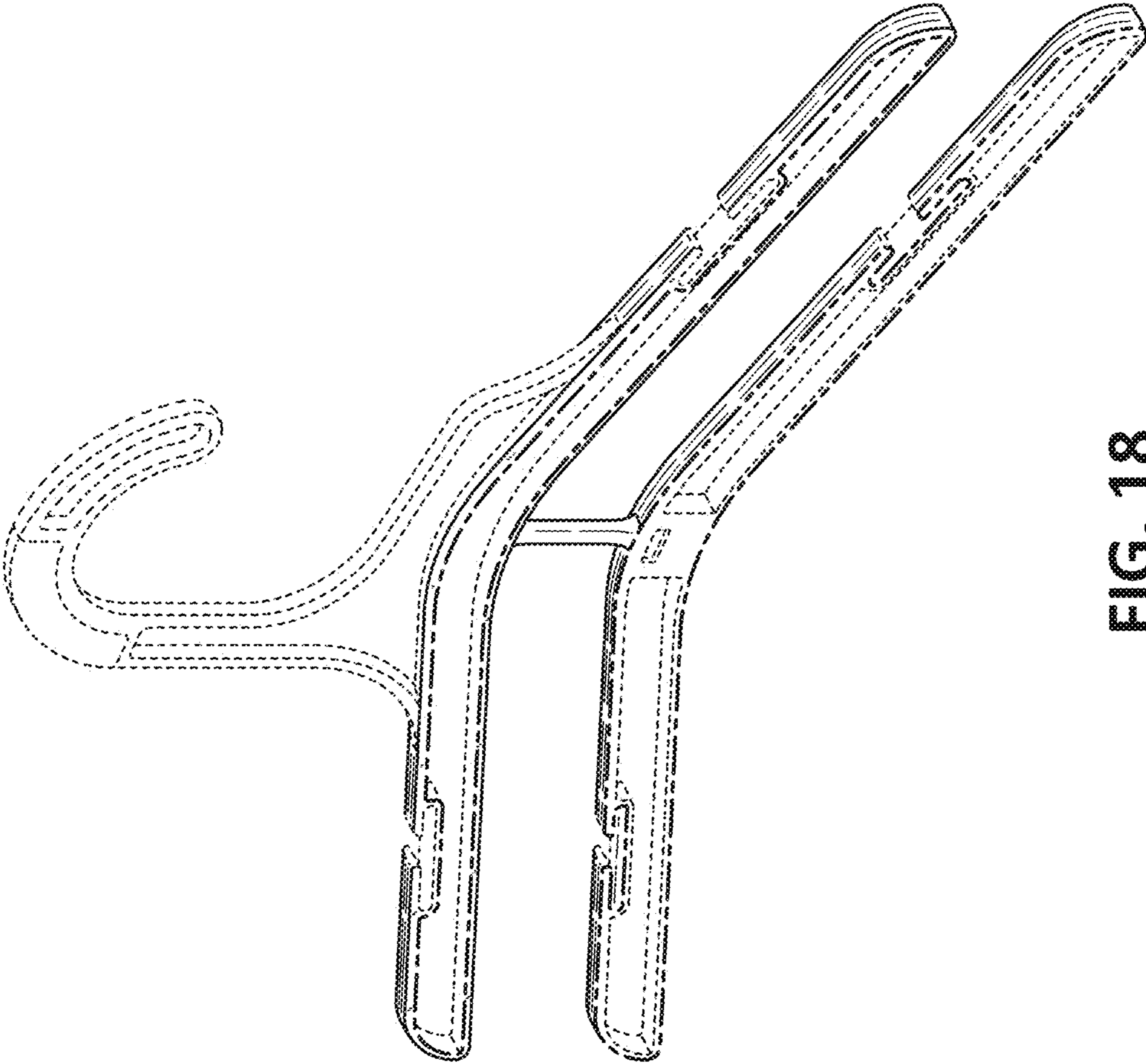

FIG. 18

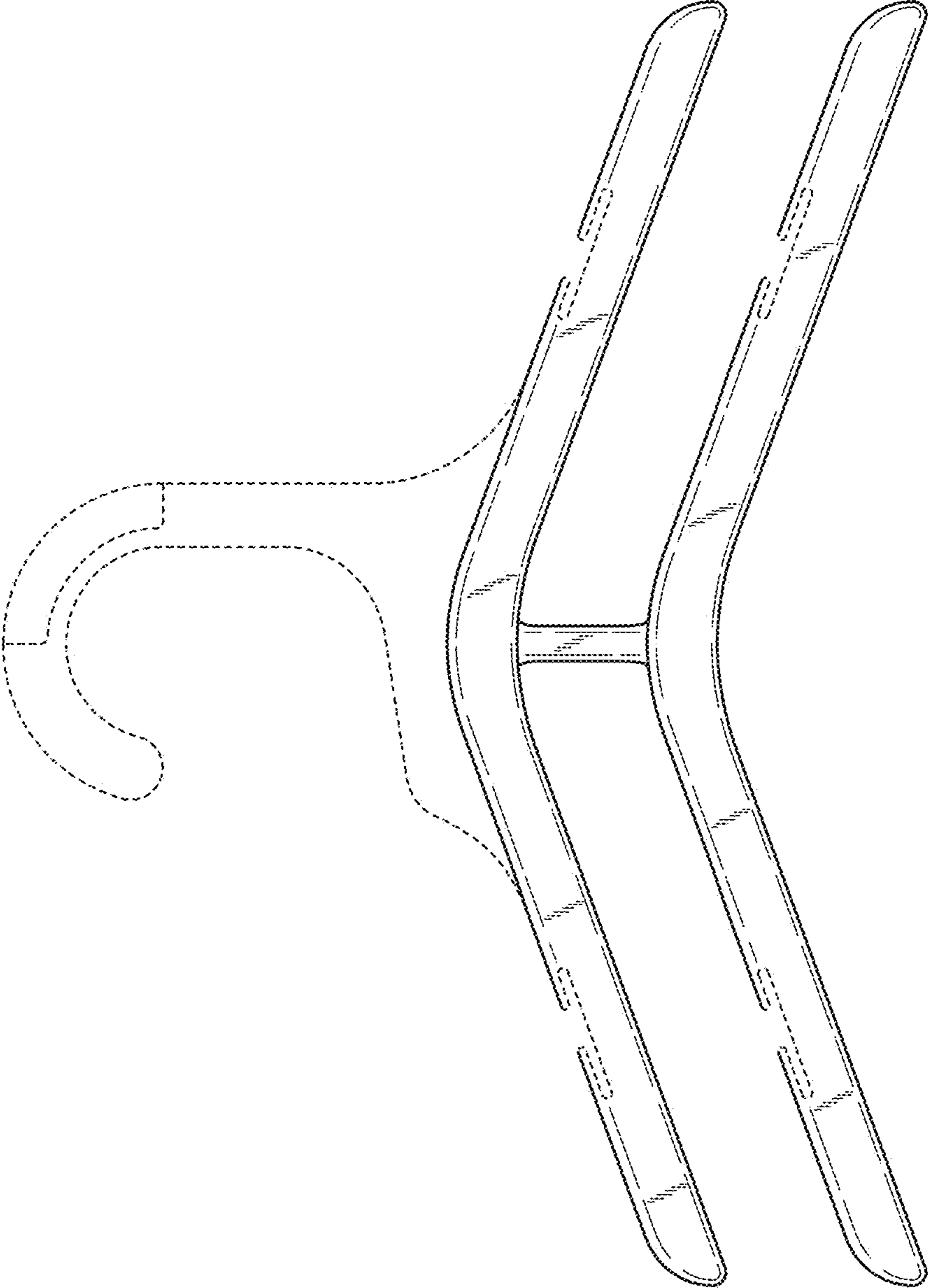

FIG. 19

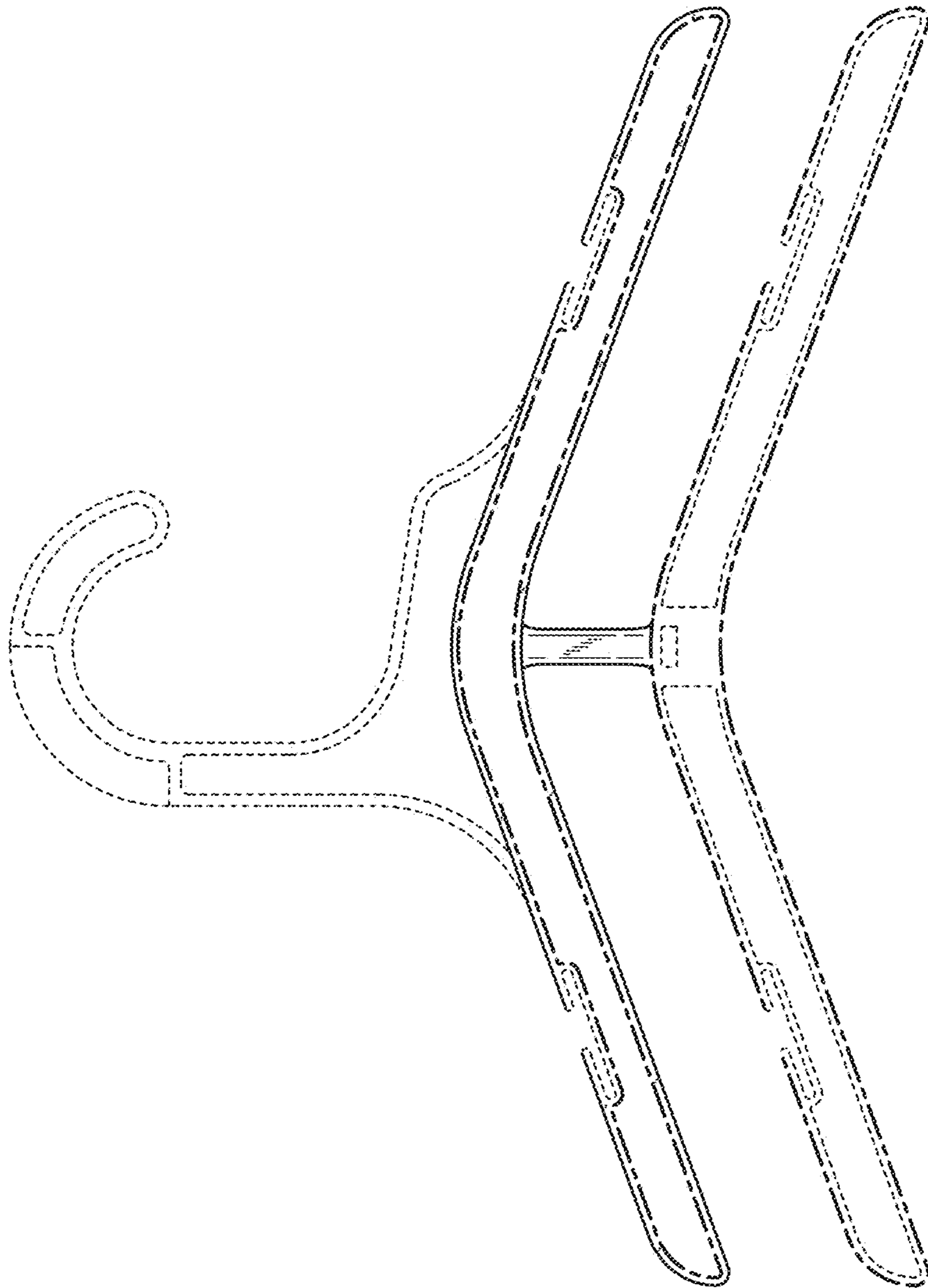

FIG. 20



FIG. 22



FIG. 21



FIG. 23

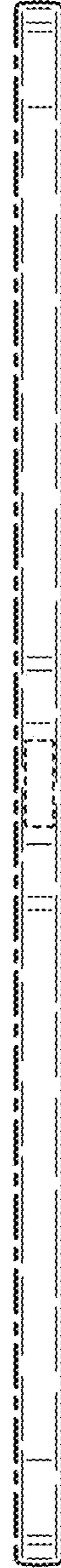

FIG. 24