



US00D929658S

(12) **United States Design Patent**
Marin

(10) **Patent No.:** **US D929,658 S**

(45) **Date of Patent:** **** Aug. 31, 2021**

(54) **COSMETIC CONTAINER**

(71) Applicant: **PRESTIGE ET COLLECTIONS INTERNATIONAL**, Paris (FR)

(72) Inventor: **Alexandra Marin**, Clichy (FR)

(73) Assignee: **PRESTIGE ET COLLECTIONS INTERNATIONAL**, Paris (FR)

(**) Term: **15 Years**

(21) Appl. No.: **29/728,101**

(22) Filed: **Mar. 16, 2020**

(51) **LOC (13) Cl.** **28-03**

(52) **U.S. Cl.**
USPC **D28/76; D28/7**

(58) **Field of Classification Search**
USPC D9/432, 434–436, 443, 445, 452, 516,
D9/529, 544, 546, 559, 560, 564, 565,
D9/570–575, 715, 719; D28/4, 7, 76, 83,
D28/85; D14/480.1, 480.3; D4/116, 128
CPC B65D 21/0204; B65D 2501/0081; A45D
40/0068; A45D 33/00; A45D 33/34
See application file for complete search history.

(56) **References Cited**

U.S. PATENT DOCUMENTS

D293,832 S *	1/1988	White	D28/76
D293,833 S *	1/1988	White	D28/76
D354,917 S *	1/1995	Kusz	D9/560
D456,609 S *	5/2002	Blom	D4/116
7,231,926 B2 *	6/2007	Kim	A46B 7/04 132/218
D572,604 S *	7/2008	Garofano	D28/77
D606,077 S *	12/2009	Hu	D14/480.1
D713,097 S *	9/2014	Goswell	D28/77
D804,491 S *	12/2017	Lin	D14/480.3

D868,576 S *	12/2019	Rosebrook	D9/418
D885,893 S *	6/2020	Tamarindo	D9/443
D889,848 S *	7/2020	Park	D4/114
D899,247 S *	10/2020	Kilduff	D9/432
2009/0279937 A1 *	11/2009	Peck	A46B 11/0003 401/128
2013/0121748 A1 *	5/2013	Ramirez	A45D 40/0068 401/116
2020/0253357 A1 *	8/2020	Roualdes	A45D 40/265

* cited by examiner

Primary Examiner — W. A. Teddy Falloway

(74) *Attorney, Agent, or Firm* — Edell, Shapiro & Finnan, LLC

(57) **CLAIM**

The ornamental design for a cosmetic container, as shown and described.

DESCRIPTION

FIG. 1 is a front, left perspective view from above of a cosmetic container.

FIG. 2 is a rear, left perspective view from below of the cosmetic container of FIG. 1.

FIG. 3 is a front elevation view of the cosmetic container of FIG. 1.

FIG. 4 is a rear elevation view of the cosmetic container of FIG. 1.

FIG. 5 is a left side elevation view of the cosmetic container of FIG. 1.

FIG. 6 is a right side elevation view of the cosmetic container of FIG. 1.

FIG. 7 is a top plan view of the cosmetic container of FIG. 1; and,

FIG. 8 is a bottom plan view of the cosmetic container of FIG. 1.

1 Claim, 4 Drawing Sheets

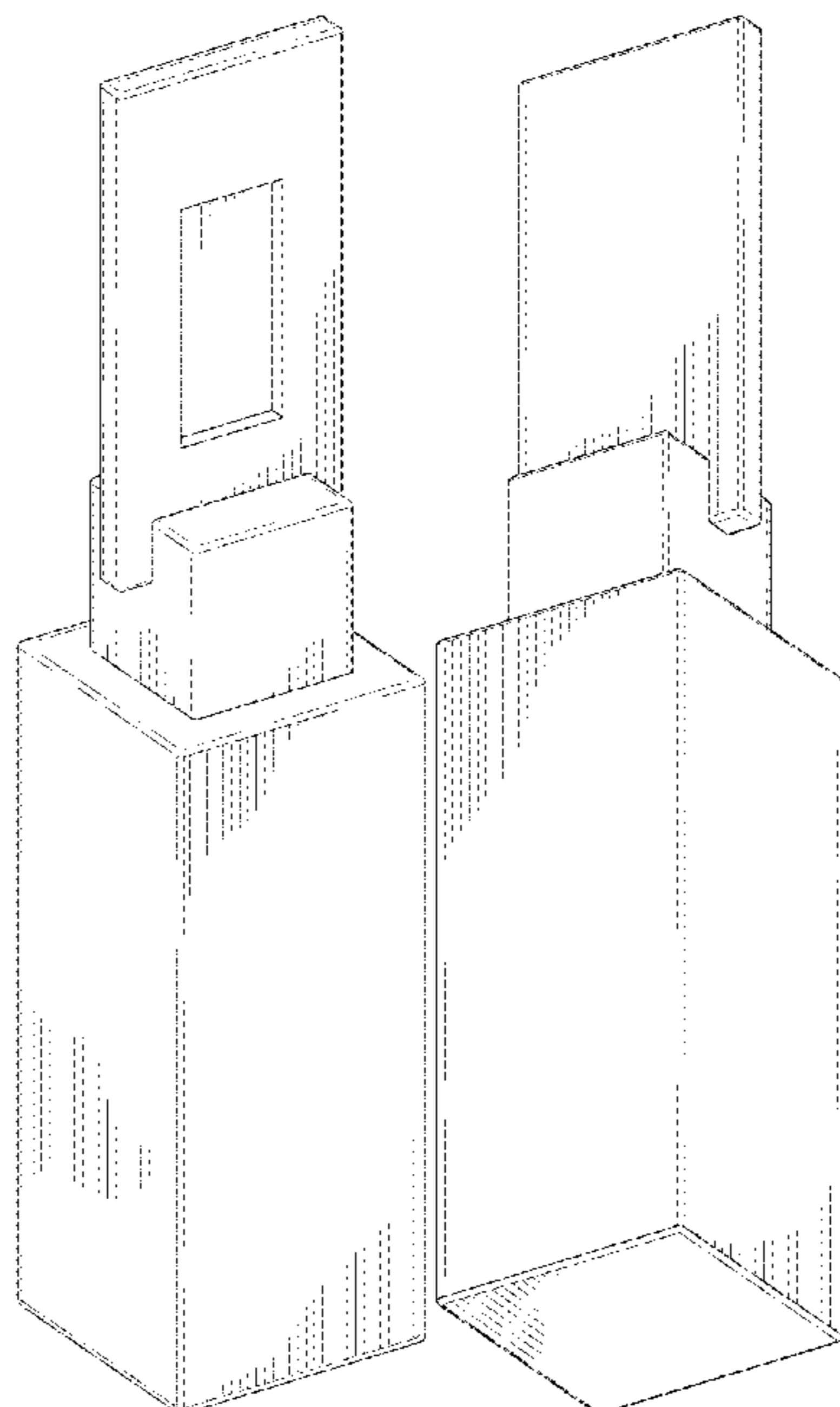

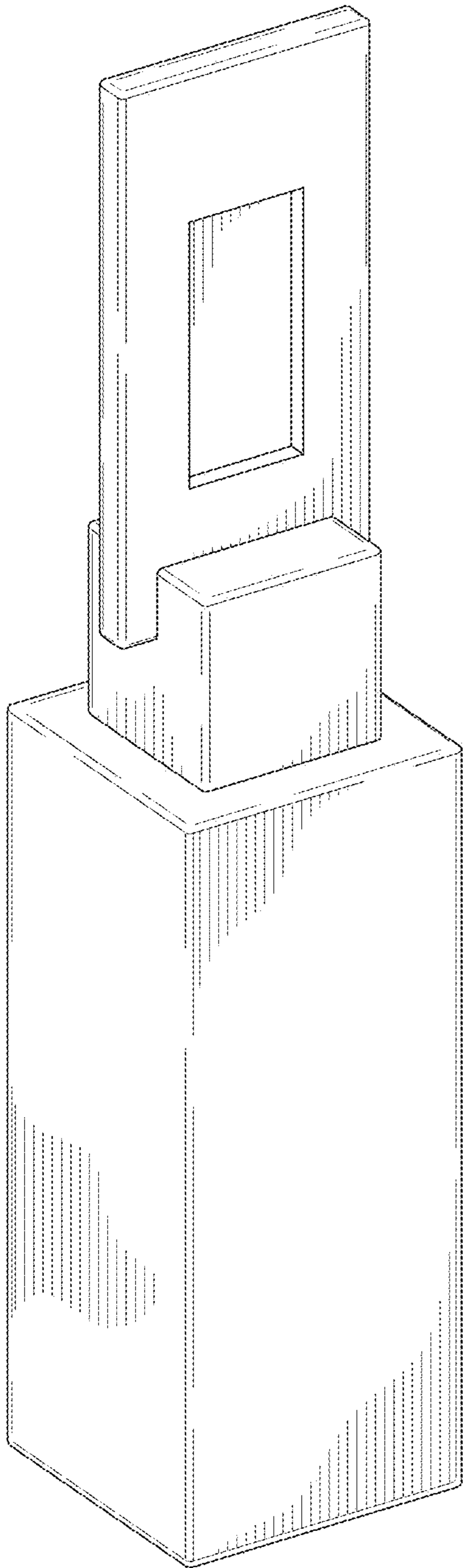

FIG.1

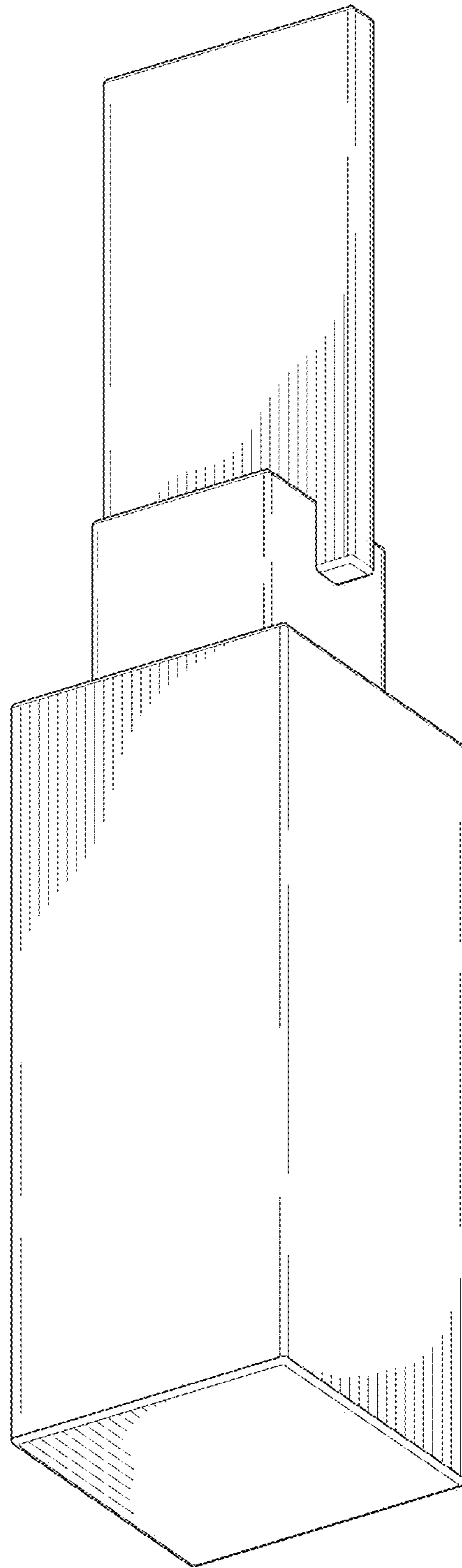

FIG.2

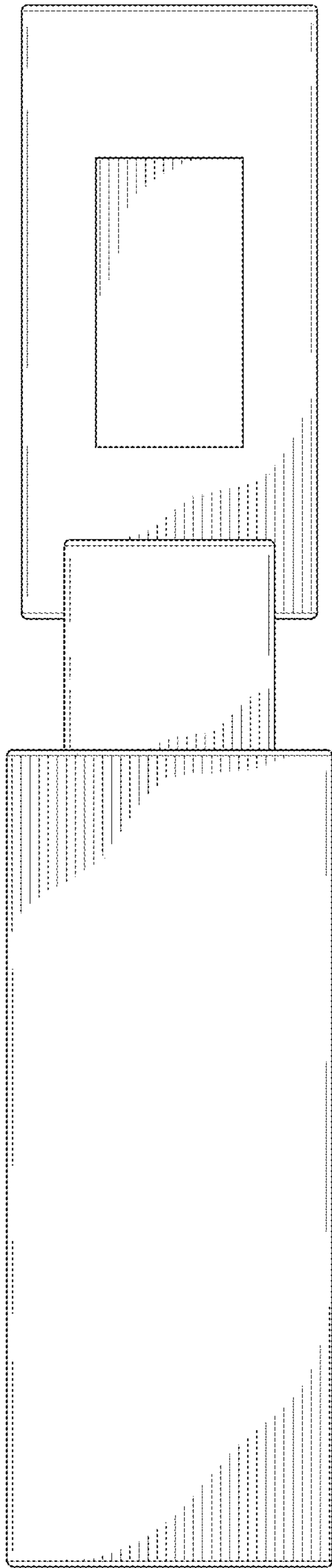

FIG.3

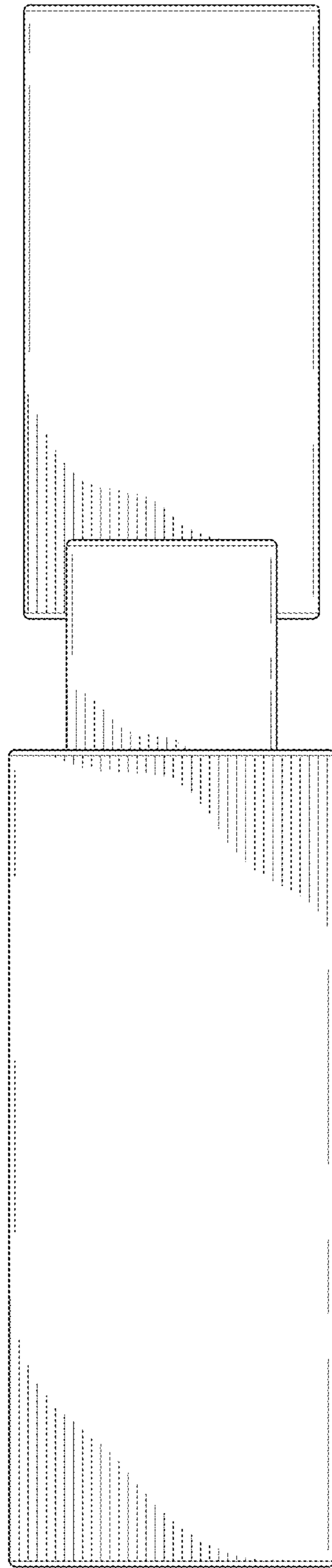

FIG.4

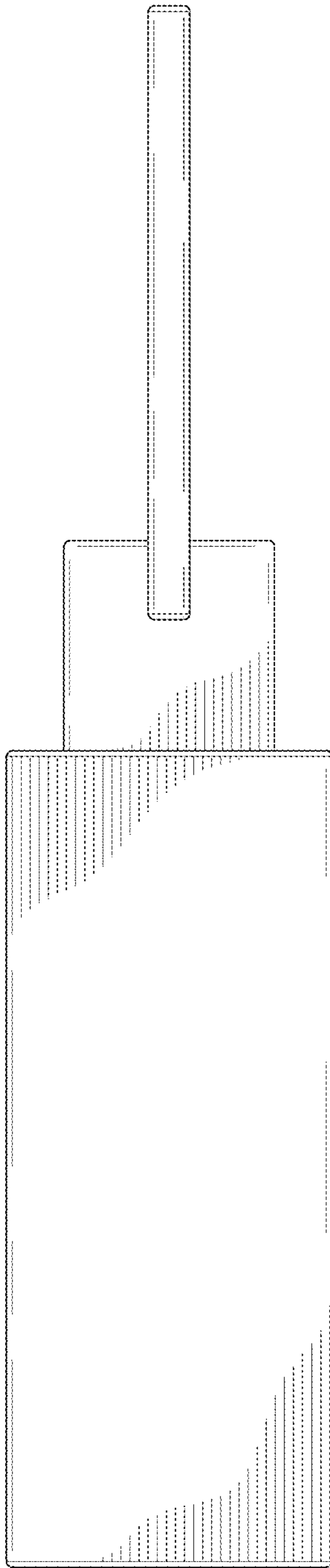

FIG. 5

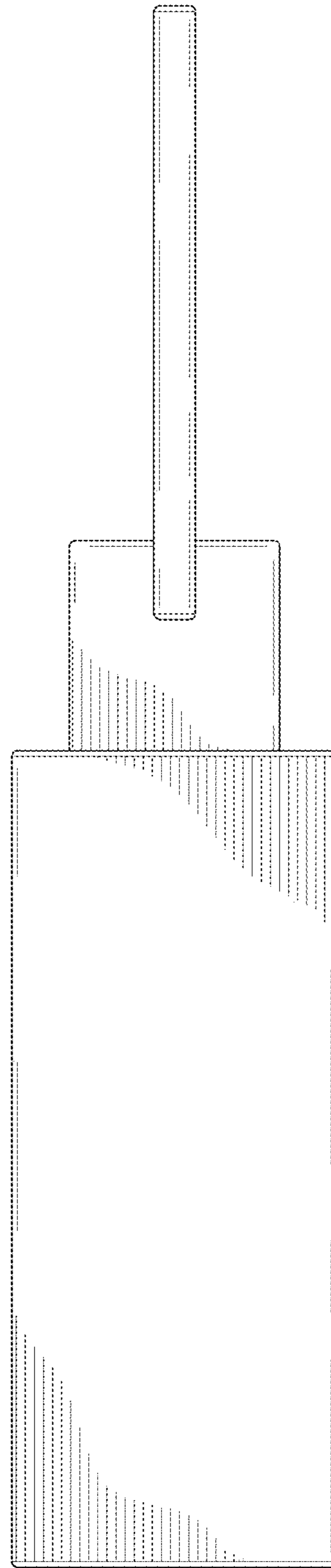

FIG. 6

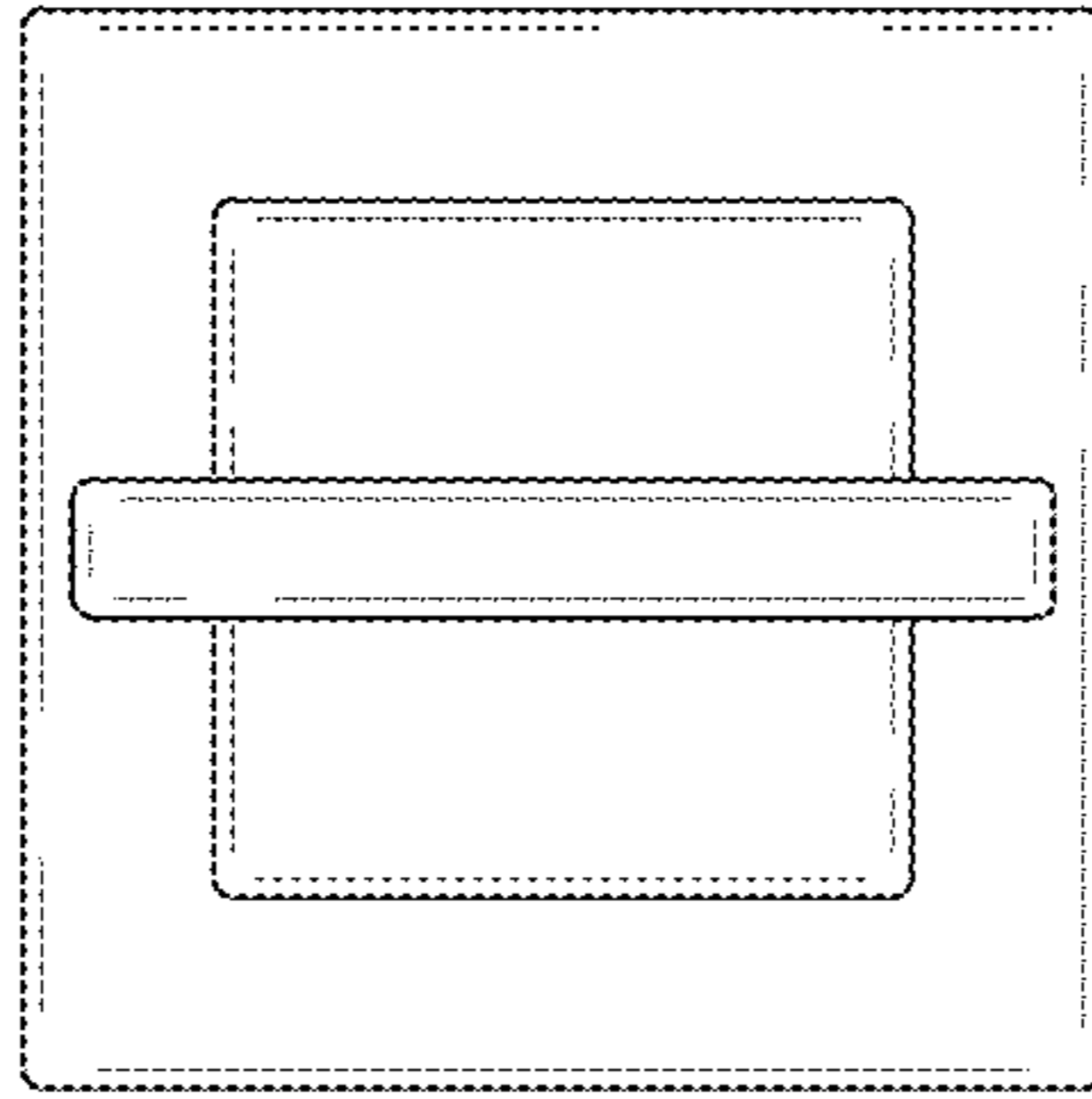

FIG. 7

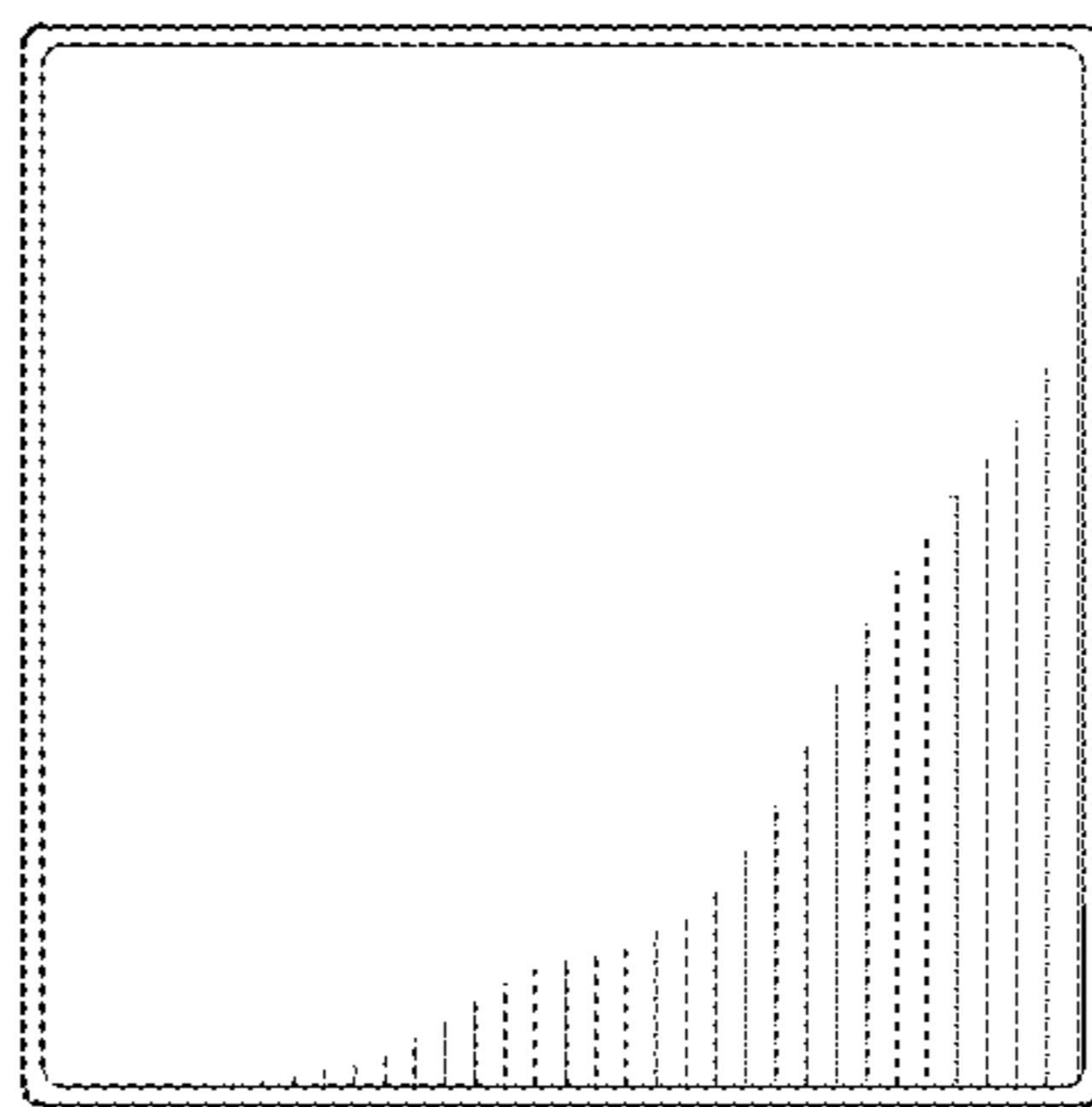

FIG. 8