



US00D929651S

(12) **United States Design Patent** (10) **Patent No.:** **US D929,651 S**
Powell et al. (45) **Date of Patent:** **** Aug. 31, 2021**

(54) **ELECTRONIC CIGARETTE VAPORIZER**

OTHER PUBLICATIONS

- (71) Applicant: **Nicoventures Trading Limited (a UK company)**, London (GB)
- (72) Inventors: **David Hillary Powell**, London (GB); **Matthew Peter Tidnam**, London (GB); **Nicholas Sandham**, London (GB); **Neil Martin Baron**, London (GB); **Mike Lin**, Shenzhen (CN)
- (73) Assignee: **Nicoventures Holdings Limited (A UK Company)**, London (GB)

Relx Electronic Cigarette Vape Pen E-Gigarettes by: RELX Feb. 17, 2020 <https://shopee.ph/Relx-Starter-Kit-NAVY-BLUE-Relx-Electric-Cigarette-Vape-i.137695431.2210852308> Dec. 20, 2020.*

(Continued)

Primary Examiner — Marissa J Cash
Assistant Examiner — Rebecca Tsehaye
(74) *Attorney, Agent, or Firm* — Patterson Thuent Pedersen, P.A.

(**) Term: **15 Years**

(57) **CLAIM**

(21) Appl. No.: **29/722,725**

We claim the ornamental design for an electronic cigarette vaporizer, as shown and described.

(22) Filed: **Jan. 31, 2020**

(30) **Foreign Application Priority Data**

DESCRIPTION

Aug. 1, 2019 (EM) 006666574

(51) **LOC (13) Cl.** **27-02**

(52) **U.S. Cl.**
USPC **D27/162**

(58) **Field of Classification Search**
USPC D27/162, 100, 101, 163–165, 172,
D27/174–176, 183, 185–194; D24/110,
D24/100.5

(Continued)

FIG. 1 is a top front perspective view of an electronic cigarette vaporizer.
FIG. 2 is a bottom front perspective view of the electronic cigarette vaporizer depicted in FIG. 1.
FIG. 3 is a front elevational view of the electronic cigarette vaporizer depicted in FIG. 1.
FIG. 4 is a rear elevational view of the electronic cigarette vaporizer depicted in FIG. 1.
FIG. 5 is a left side elevational view of the electronic cigarette vaporizer depicted in FIG. 1.
FIG. 6 is a right side elevational view of the electronic cigarette vaporizer depicted in FIG. 1.
FIG. 7 is a top plan view of the electronic cigarette vaporizer depicted in FIG. 1; and,
FIG. 8 is a bottom plan view of the electronic cigarette vaporizer depicted in FIG. 1.
The broken lines in the drawings illustrate portions of the electronic cigarette vaporizer that form no part of the claimed design.

(56) **References Cited**

U.S. PATENT DOCUMENTS

D140,839 S 4/1945 Carson
D197,689 S 3/1964 Levin et al.

(Continued)

FOREIGN PATENT DOCUMENTS

AU 201710494 S 4/2017
CA 2420623 C 3/2005

(Continued)

1 Claim, 8 Drawing Sheets

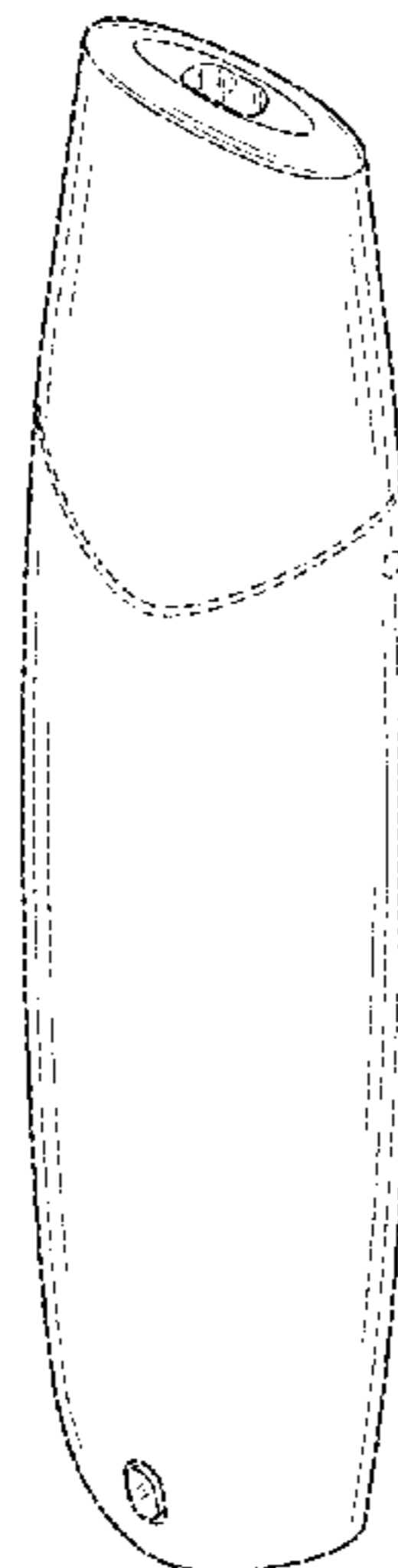

(58) **Field of Classification Search**
 CPC A24F 47/002; A24F 47/006; A24F 47/008;
 A61M 15/00; A61M 15/06
 See application file for complete search history.

(56) **References Cited**

U.S. PATENT DOCUMENTS

D201,420 S 6/1965 Bernard et al.
 D237,017 S 9/1975 Beaufour
 D299,066 S 12/1988 Newell et al.
 D329,253 S 9/1992 Sekiguchi
 D365,889 S 1/1996 Kim
 D401,011 S 11/1998 Sloan, II
 D418,253 S 12/1999 Bakic
 D424,739 S 5/2000 Ross
 D426,030 S 5/2000 Heeter et al.
 D470,529 S 2/2003 Tu
 D485,639 S 1/2004 Stronski
 D499,029 S 11/2004 Maarberg
 D527,817 S 9/2006 Ziegler et al.
 D532,927 S 11/2006 Sann
 D579,498 S 10/2008 Bhavnani et al.
 D602,089 S 10/2009 Keda
 D641,409 S 7/2011 Wang et al.
 D644,375 S 8/2011 Zhou
 D669,123 S 10/2012 Jiang
 D673,325 S 12/2012 Martines
 D676,621 S 2/2013 Florkiewicz et al.
 8,499,766 B1 8/2013 Newton
 D690,383 S 9/2013 Sheikh et al.
 D691,324 S 10/2013 Saliman
 D695,450 S 12/2013 Benassayag et al.
 D696,455 S 12/2013 Abroff
 D697,616 S 1/2014 Berry et al.
 D707,484 S 6/2014 Fee
 D710,052 S 7/2014 Lanca
 D718,492 S 11/2014 Albanese
 D720,095 S 12/2014 Alima
 D720,496 S 12/2014 Alima
 D720,499 S 12/2014 Alima
 D720,882 S 1/2015 Albanese
 D720,883 S 1/2015 Albanese
 D721,202 S 1/2015 Liu
 D723,216 S 2/2015 Chen
 D725,310 S 3/2015 Eksouzian
 D736,994 S 8/2015 Mittersinker et al.
 D737,419 S * 8/2015 Emarlou D23/360
 D742,065 S 10/2015 Leidel
 D743,622 S 11/2015 Alima
 D745,477 S 12/2015 Nitz
 D748,853 S 2/2016 Seibel et al.
 D750,834 S 3/2016 Wei
 D750,835 S 3/2016 Wei
 D752,278 S 3/2016 Verleur et al.
 D752,807 S 3/2016 Young et al.
 D753,874 S 4/2016 Moreno Medina et al.
 D756,031 S 5/2016 Wu
 D757,352 S 5/2016 Bagai
 D759,297 S 6/2016 Liu
 D760,948 S 7/2016 Eksouzian
 D761,998 S 7/2016 Pinder
 D763,501 S 8/2016 McGarry et al.
 D763,502 S 8/2016 Verleur et al.
 D764,701 S 8/2016 Malhi
 D768,915 S 10/2016 Wright et al.
 D773,727 S 12/2016 Eksouzian
 D775,412 S 12/2016 Di Bari
 D776,337 S 1/2017 Levin et al.
 D776,869 S 1/2017 Heidl
 D778,493 S 2/2017 Scott
 D779,719 S 2/2017 Qiu
 D780,991 S 3/2017 Liu
 D782,728 S 3/2017 Pinder
 D782,729 S 3/2017 Wright et al.
 D785,862 S 5/2017 Wu
 D786,497 S 5/2017 Sudlow et al.

D787,114 S 5/2017 Scott
 D790,123 S 6/2017 Beer et al.
 D790,124 S 6/2017 Beer et al.
 D790,125 S 6/2017 Beer et al.
 D792,021 S 7/2017 Beer et al.
 D792,643 S 7/2017 Wong et al.
 D795,496 S 8/2017 Beer et al.
 D798,500 S 9/2017 Joyce, III et al.
 9,763,477 B2 9/2017 Zhu
 D799,110 S 10/2017 Qiu
 D799,112 S 10/2017 Qiu
 D799,113 S 10/2017 Qiu
 D799,745 S 10/2017 Qiu
 D799,748 S 10/2017 Freese
 D799,749 S 10/2017 Freese
 D800,383 S 10/2017 Verleur et al.
 D802,839 S 11/2017 Scott
 D804,091 S 11/2017 Fornarelli
 D804,717 S 12/2017 Wang et al.
 D805,246 S 12/2017 Fakhouri
 D805,684 S 12/2017 Thuery
 D806,310 S 12/2017 McGarry et al.
 D807,574 S 1/2018 Hawes et al.
 D808,071 S 1/2018 Folkerts et al.
 D813,447 S 3/2018 Watson
 9,907,930 B2 3/2018 Trzeciecki
 9,924,566 B2 3/2018 Duffield et al.
 D815,341 S 4/2018 Qiu
 D815,619 S 4/2018 Moudgill et al.
 9,943,112 B2 4/2018 Liu
 D818,636 S * 5/2018 Qiu D27/101
 D818,638 S 5/2018 Wright et al.
 D818,639 S 5/2018 Kayvon et al.
 D819,263 S 5/2018 Zhu
 9,961,940 B2 5/2018 Anderson, Jr. et al.
 9,980,511 B2 5/2018 Liu
 D820,514 S 6/2018 Durand
 D820,515 S 6/2018 Nettenstrom et al.
 D822,271 S 7/2018 Eksouzian
 D823,536 S * 7/2018 Lai D27/163
 D824,096 S 7/2018 Qiu
 D825,099 S 8/2018 Wright et al.
 D825,102 S 8/2018 Bowen et al.
 D825,103 S 8/2018 Wright et al.
 D825,834 S 8/2018 Chen
 D827,195 S * 8/2018 Chen D27/101
 D829,372 S 9/2018 Huang et al.
 D829,373 S * 9/2018 Huang D27/101
 10,064,434 B2 9/2018 Zitzke et al.
 D829,980 S 10/2018 Qiu
 D830,625 S 10/2018 Stone
 D832,499 S 10/2018 Qiu
 D832,500 S 10/2018 Qiu
 D834,246 S 11/2018 Qiu
 D835,337 S 12/2018 Beer et al.
 D836,831 S 12/2018 Cividi
 10,159,285 B2 12/2018 Watson
 D837,446 S * 1/2019 Durand D27/101
 D838,899 S 1/2019 Qiu
 D838,900 S 1/2019 Freese
 D842,536 S 3/2019 Bowen et al.
 D844,223 S 3/2019 Bao
 D844,225 S 3/2019 Bao
 D844,235 S 3/2019 Cividi
 D844,236 S 3/2019 Tidnam et al.
 D844,240 S 3/2019 Kauss
 D844,891 S 4/2019 Stoll
 D846,796 S 4/2019 Pan
 10,299,517 B2 5/2019 Hawes et al.
 D850,712 S 6/2019 Fornarelli
 D851,827 S 6/2019 Clark
 D853,633 S 7/2019 Zeng
 D855,251 S 7/2019 Qiu et al.
 D855,875 S * 8/2019 Yan D27/101
 D855,876 S 8/2019 Martin
 D855,877 S 8/2019 Folkerts et al.
 D855,878 S 8/2019 Qiu et al.
 D855,882 S 8/2019 Flood et al.
 D858,872 S 9/2019 White et al.

(56)

References Cited

U.S. PATENT DOCUMENTS

D859,735 S 9/2019 Qiu et al.
 D860,520 S 9/2019 Cividi
 D861,240 S 9/2019 Qiu et al.
 D861,974 S 10/2019 Zhao
 D863,665 S 10/2019 Huang et al.
 D863,670 S 10/2019 He et al.
 D863,675 S * 10/2019 Huang D27/163
 D864,474 S 10/2019 Smith
 D866,064 S 11/2019 Powell et al.
 D866,852 S 11/2019 Cividi
 D868,360 S 11/2019 Stone
 D868,361 S 11/2019 Stone
 D869,085 S 12/2019 Campbell et al.
 D870,369 S 12/2019 Greenbaum et al.
 D870,370 S 12/2019 Greenbaum et al.
 D870,372 S 12/2019 Zhu
 D872,355 S 1/2020 Powell et al.
 D872,932 S 1/2020 Powell et al.
 D872,934 S 1/2020 Powell et al.
 D875,302 S 2/2020 Pan
 D877,976 S 3/2020 Ding et al.
 D883,569 S 5/2020 Powell et al.
 D885,652 S * 5/2020 Ding D27/162
 D887,631 S * 6/2020 Lai D27/162
 D889,736 S 7/2020 Han
 D890,417 S 7/2020 Austin et al.
 D892,397 S * 8/2020 Li D27/162
 D893,094 S 8/2020 Wang
 D900,385 S 10/2020 Wang
 D900,386 S 10/2020 Wang
 D901,067 S * 11/2020 Powell D27/101
 D901,761 S * 11/2020 Zhu D27/162
 D902,480 S 11/2020 Chen et al.
 D903,191 S * 11/2020 Li D27/101
 D904,680 S 12/2020 Pan
 D907,290 S 1/2021 Pan
 D912,311 S 3/2021 Bennett et al.
 2010/0200008 A1 8/2010 Taieb
 2013/0042865 A1 2/2013 Monsees et al.
 2013/0152954 A1 6/2013 Youn
 2013/0199528 A1 8/2013 Goodman et al.
 2014/0026903 A1 1/2014 Haider
 2014/0158129 A1 6/2014 Pratt, Jr. et al.
 2014/0283858 A1 9/2014 Liu
 2015/0034104 A1 2/2015 Zhou
 2015/0059786 A1 3/2015 Li et al.
 2015/0101623 A1 4/2015 Liu
 2015/0114406 A1 4/2015 Newton
 2015/0128971 A1 5/2015 Verleur et al.
 2015/0150307 A1 6/2015 Liu
 2015/0164141 A1 6/2015 Newton
 2015/0181930 A1 7/2015 Liu
 2015/0181940 A1 7/2015 Liu
 2015/0196055 A1 7/2015 Liu
 2015/0208728 A1 7/2015 Lord
 2015/0333542 A1 11/2015 Alarcon et al.
 2015/0335075 A1 11/2015 Minskoff et al.
 2015/0342255 A1 12/2015 Wu
 2016/0050976 A1 2/2016 Righetti
 2016/0113325 A1 4/2016 Liu
 2016/0150823 A1 6/2016 Liu
 2016/0204637 A1 7/2016 Alarcon et al.
 2016/0213065 A1 7/2016 Wensley et al.
 2016/0270441 A1 9/2016 Lewis et al.
 2016/0270446 A1 9/2016 Shenkal et al.
 2016/0278163 A1 9/2016 Chen
 2016/0278436 A1 9/2016 Verleur et al.
 2016/0286864 A1 10/2016 Lin
 2016/0366941 A1 12/2016 Lin
 2017/0035117 A1 2/2017 Lin
 2017/0055574 A1 3/2017 Kaufman et al.
 2017/0055575 A1 3/2017 Wilke et al.
 2017/0055580 A1 3/2017 Blandino et al.
 2017/0055581 A1 3/2017 Wilke et al.
 2017/0055582 A1 3/2017 Blandino et al.

2017/0055583 A1 3/2017 Blandino et al.
 2017/0055584 A1 3/2017 Blandino et al.
 2017/0056912 A1 3/2017 Choi et al.
 2017/0095623 A1 4/2017 Trzeciecki
 2017/0119046 A1 5/2017 Kaufman et al.
 2017/0119047 A1 5/2017 Blandino et al.
 2017/0119048 A1 5/2017 Kaufman et al.
 2017/0119049 A1 5/2017 Blandino et al.
 2017/0119050 A1 5/2017 Blandino et al.
 2017/0119051 A1 5/2017 Blandino et al.
 2017/0135403 A1 5/2017 Liu
 2017/0215474 A1 8/2017 Li
 2017/0215478 A1 8/2017 Harrison et al.
 2017/0224021 A1 8/2017 Xiang
 2017/0273359 A1 9/2017 Liu
 2017/0359858 A1 12/2017 Liu
 2018/0002803 A1 1/2018 Niboshi et al.
 2018/0027877 A1 2/2018 Tucker et al.
 2018/0043114 A1 2/2018 Bowen et al.
 2018/0098568 A1 4/2018 Qiu
 2018/0098571 A1 4/2018 Watson
 2018/0132527 A1 5/2018 Bell
 2018/0153221 A1 6/2018 Verleur et al.
 2018/0184715 A1 7/2018 Liu
 2018/0279682 A1 10/2018 Guo et al.
 2018/0289058 A1 10/2018 Chen
 2018/0310618 A1 11/2018 Watson
 2019/0029319 A1 1/2019 Moorman
 2019/0029326 A1 1/2019 Qiu
 2019/0037926 A1 2/2019 Qiu
 2019/0053542 A1 2/2019 Chen
 2019/0083720 A1 3/2019 Leadley et al.
 2019/0124990 A1 5/2019 Qiu
 2019/0191780 A1 6/2019 Wilke et al.
 2019/0239555 A1 8/2019 Nicholson

FOREIGN PATENT DOCUMENTS

CA 2649802 A1 5/2008
 CA 2947261 A1 11/2015
 CA 2965051 A1 5/2016
 CA 3028019 A1 1/2018
 CA 3028023 A1 1/2018
 CN 203162984 U 8/2013
 CN 302876551 S 7/2014
 CN 303115457 S 2/2015
 CN 104432543 A 3/2015
 EM 0012790200001 7/2011
 EM 0013076310024 1/2012
 EM 0013165330003 6/2012
 EM 0033460220012 8/2016
 EP 2157873 B1 7/2011
 EP 2493341 B1 7/2013
 EP 2725681 A2 4/2014
 EP 2756893 A1 7/2014
 EP 2234728 B1 10/2014
 EP 2399637 B1 10/2014
 EP 2978481 B1 12/2016
 EP 2654469 B1 3/2017
 EP 3141135 A1 3/2017
 EP 3207811 A1 8/2017
 EP 3210480 A1 8/2017
 EP 3210481 A1 8/2017
 EP 2797446 B1 10/2017
 EP 3217816 B1 10/2018
 EP 3387928 A1 10/2018
 EP 1465694 B1 11/2018
 EP 3316714 B1 11/2018
 EP 3406285 A1 11/2018
 EP 2835063 B1 4/2019
 EP 3253237 B1 4/2019
 EP 3282871 B1 6/2019
 EP 3506721 A1 7/2019
 JP 4322936 B2 9/2009
 JP 1519006 S 3/2015
 JP 1519007 S 3/2015
 JP 1561415 S 10/2016
 JP 1563215 S 11/2016
 JP 1563216 S 11/2016

(56)

References Cited

FOREIGN PATENT DOCUMENTS

JP	1605700	S	6/2018
JP	1605701	S	6/2018
JP	2018174931	A	11/2018
JP	6522220	B1	5/2019
KR	100449444	B1	8/2005
KR	20120034933	A	4/2012
KR	300681840		2/2013
KR	3006818401		5/2013
KR	3006818402		5/2013
KR	300721563000		12/2013
RU	96946	U1	8/2010
WO	WO-2006028843	A2	3/2006
WO	WO-2010145805	A1	12/2010
WO	WO-DM081209		7/2013
WO	WO-2013113612	A1	8/2013
WO	WO-2014066730	A1	5/2014
WO	WO-2014134813	A1	9/2014
WO	WO-2014134816	A1	9/2014
WO	WO-2014163664	A1	10/2014
WO	WO-2014183073	A1	11/2014
WO	WO-2015069914	A1	5/2015
WO	WO-2016000208	A1	1/2016
WO	WO-2016029225	A1	2/2016
WO	WO-2016082183	A1	6/2016
WO	WO-2016106493	A1	7/2016
WO	WO-2016115689	A1	7/2016
WO	WO-2016124741	A1	8/2016
WO	WO-2016145634	A1	9/2016
WO	WO-2016210242	A1	12/2016
WO	WO-2017025500	A1	2/2017
WO	WO-2017108429	A1	6/2017
WO	WO-2017147560	A1	8/2017
WO	WO-2017186023	A1	11/2017
WO	WO-2017214788	A1	12/2017
WO	WO-2018023188	A1	2/2018
WO	WO-2018083037	A1	5/2018
WO	WO-2018134159	A1	7/2018
WO	WO-2018138072	A1	8/2018
WO	WO-2018166925	A1	9/2018
WO	WO-2018178095	A1	10/2018
WO	WO-2018178113	A2	10/2018
WO	WO-2018178114	A2	10/2018
WO	WO-2018178216	A1	10/2018
WO	WO-2018178217	A1	10/2018
WO	WO-2018178218	A1	10/2018
WO	WO-2018178219	A1	10/2018

WO	WO-2018192722	A1	10/2018
WO	WO-2018220558	A1	12/2018
WO	WO-2018223560	A1	12/2018
WO	WO-2018228131	A1	12/2018
WO	WO-2019053268	A1	3/2019
WO	WO-2019104441	A1	6/2019
WO	WO-2019110730	A1	6/2019
WO	WO-2019148328	A1	8/2019
WO	WO-2019162370	A1	8/2019

OTHER PUBLICATIONS

U.S. Appl. No. 29/722,731, filed Jan. 31, 2020. Inventors: Powell et al., 111 pages.

U.S. Appl. No. 29/722,733, filed Jan. 31, 2020. Inventor: Lin, 97 pages.

“Black Mamba Dry Herb Vaporizer by BLK”, Sep. 17, 2017, https://www.amazon.co.uk/Black-Mamba-Dry-Herb-Vaporizer/product-reviews/B-074WCDJ5W/ref=cm_cr_getr_d_paging_btm_next_2?ie=UTF8&reviewerType=all_reviews&sortBy=recent&pageNumber=2, 1 page.

Decision to Grant in Russian Application No. 201850023949, dated Jul. 6, 2018, 4 pages.

Decision to Grant in Russian Application No. 201850024049, dated Jul. 6, 2018, 4 pages.

Notice of Allowance dated Apr. 3, 2018 for Japanese Application No. 2018-000975, 4 pages.

Notice of Allowance dated Apr. 3, 2018 for Japanese Application No. 2018-000974, 4 pages.

Office Action dated Jul. 2, 2020 for Japanese Application No. 2020-001929, 2 pages.

Office Action dated Jul. 2, 2020 for Japanese Application No. 2020-001935, 2 pages.

U.S. Appl. No. 29/652,210, filed Jun. 11, 2020. Inventors: Powell et al., 57 pages.

U.S. Appl. No. 29/652,211, filed Jun. 11, 2020. Inventors: Powell et al., 57 pages.

U.S. Appl. No. 29/652,212, filed Jun. 18, 2020. Inventors: Powell et al., 68 pages.

Application for Registered Community Designs RCD Application No. 006666574, filed Aug. 1, 2019, 28 pages.

Application for Registered Community Designs RCD Application No. 004115228, filed Jul. 21, 2017, 25 pages.

Application for Registered Community Designs RCD Application No. 004419653, filed Oct. 24, 2017, 30 pages.

* cited by examiner

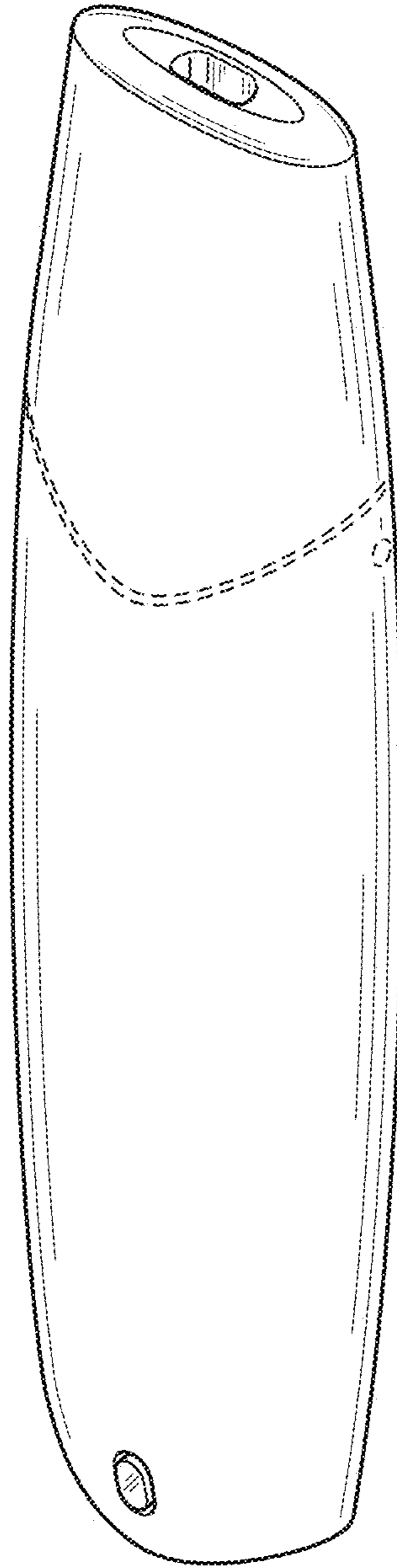

FIG. 1

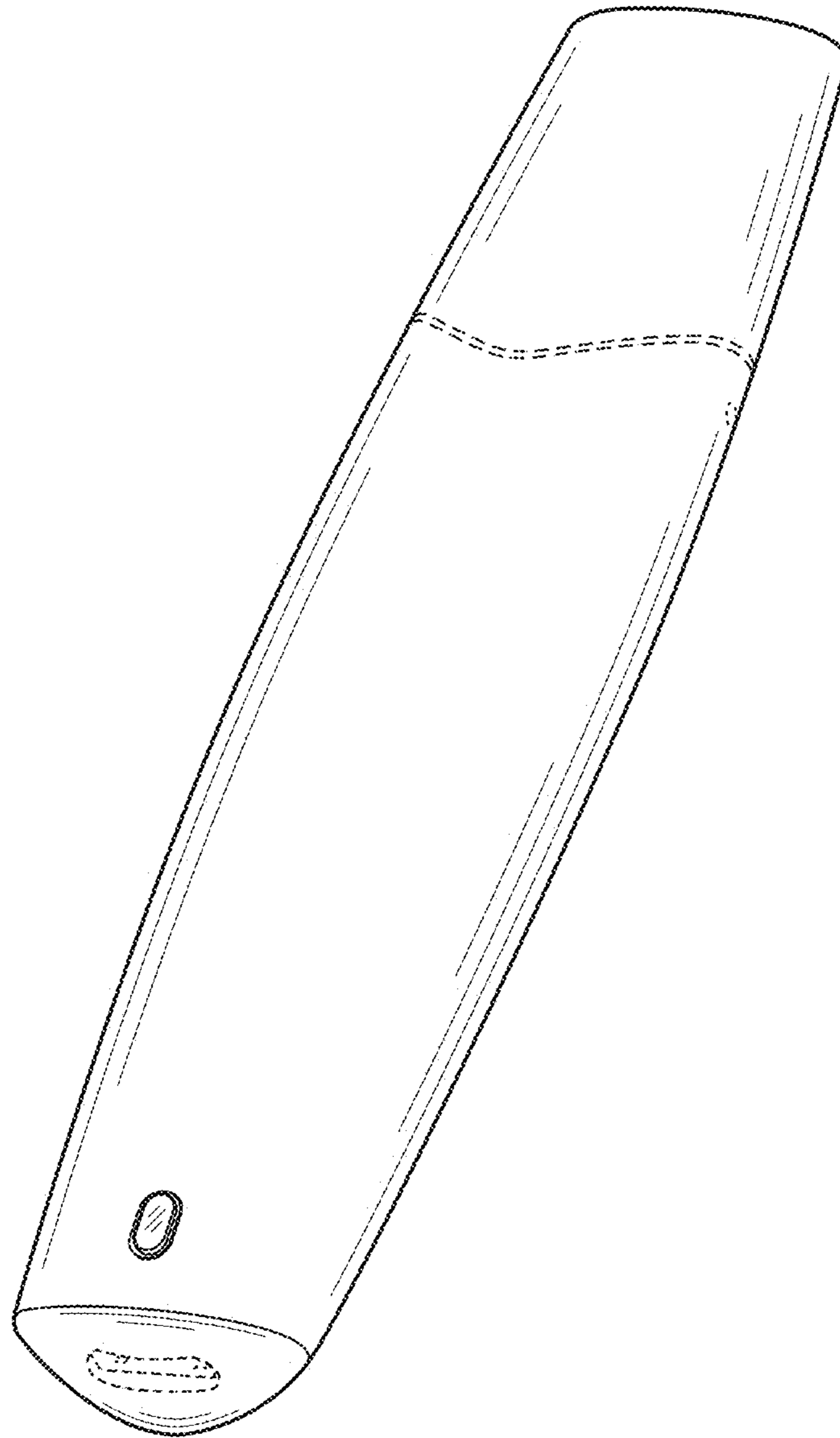

FIG. 2

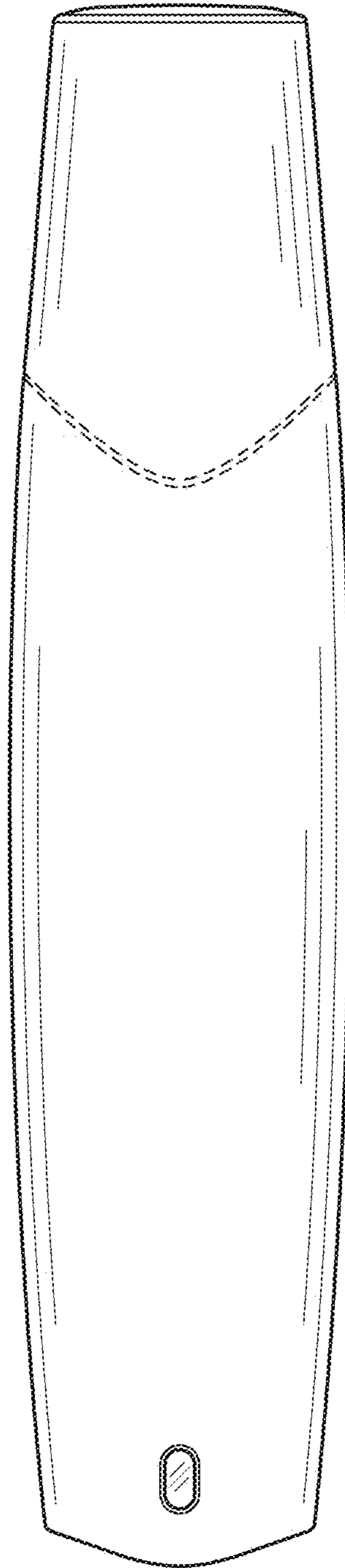

FIG. 3

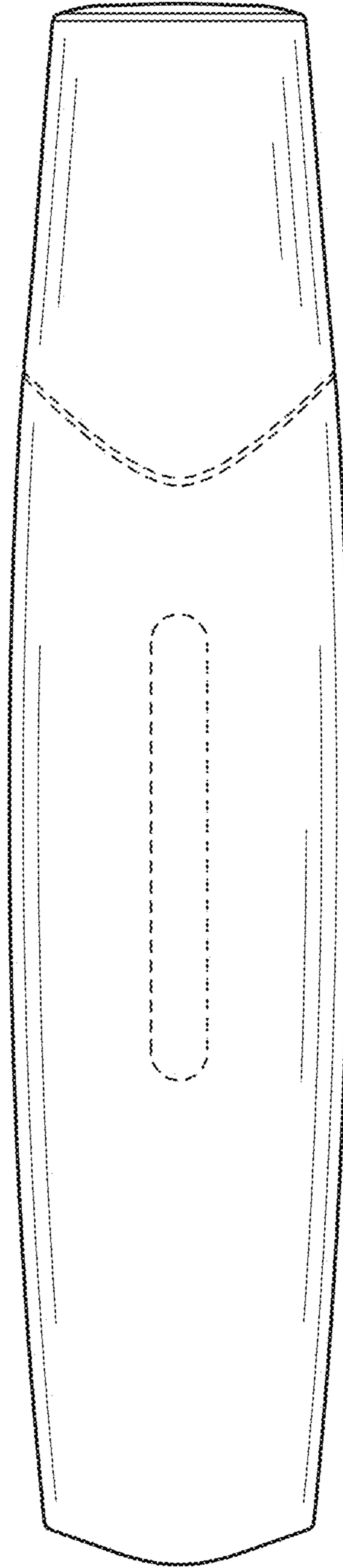

FIG. 4

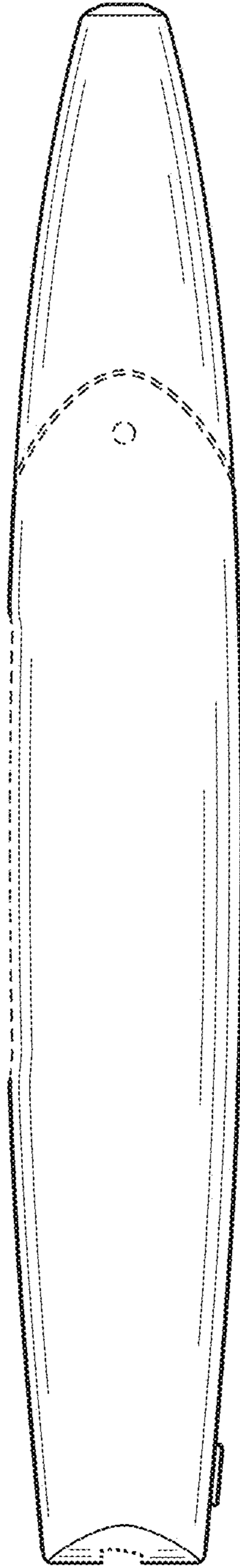

FIG. 5

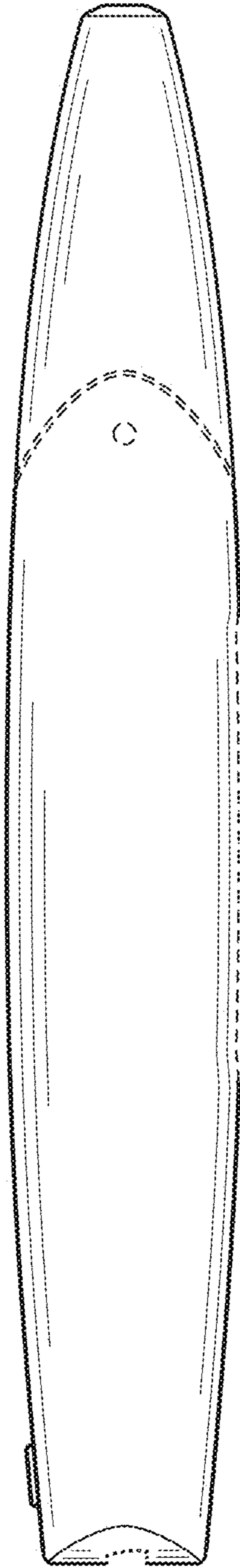

FIG. 6

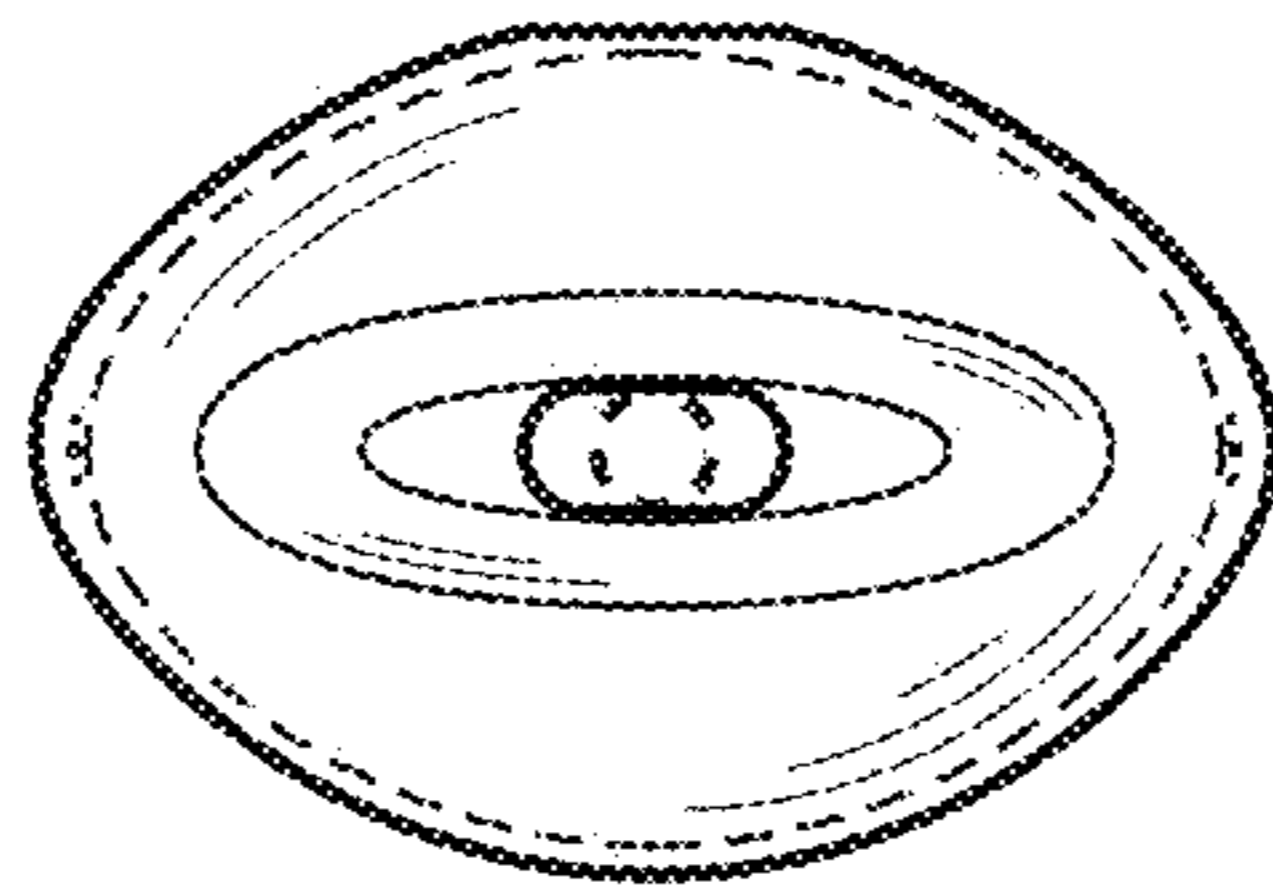

FIG. 7

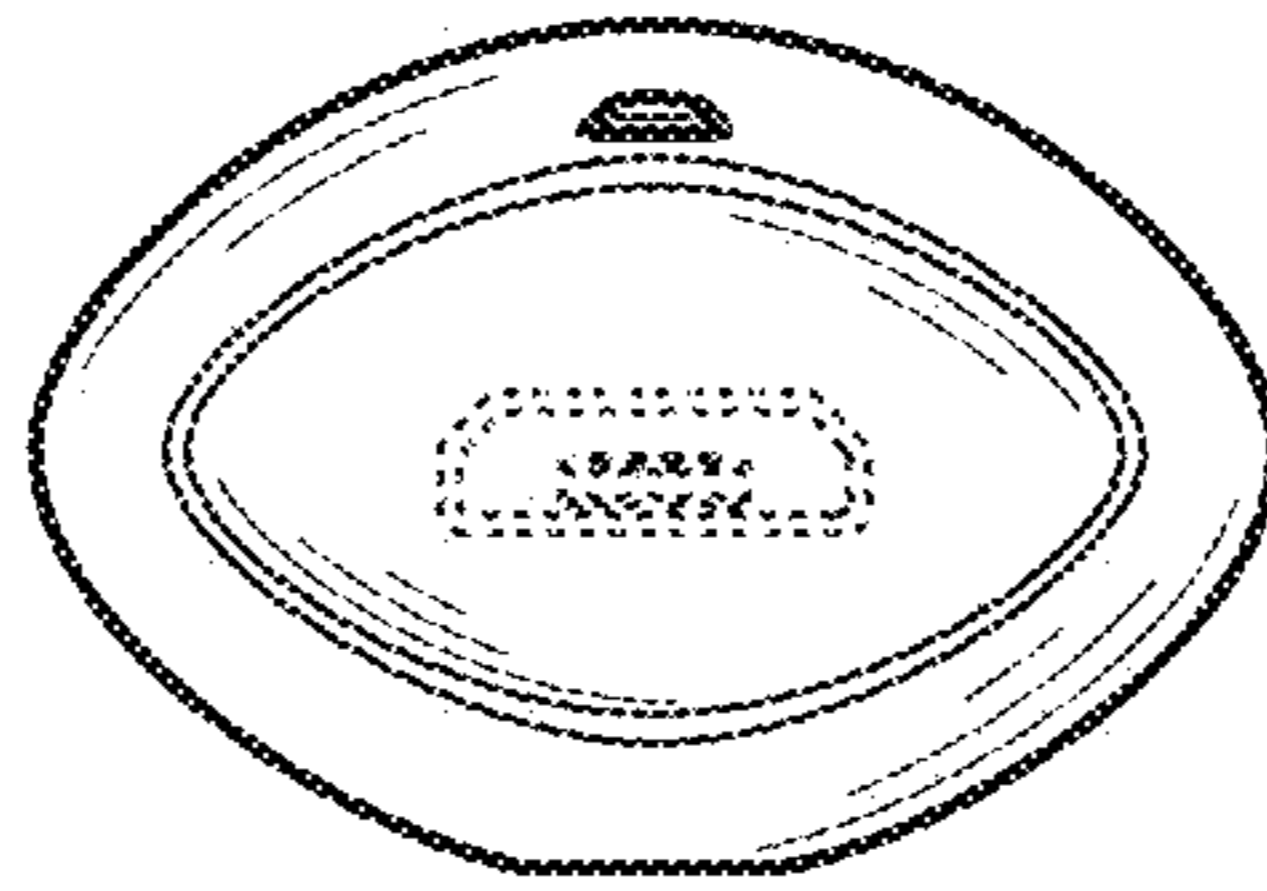

FIG. 8