



US00D929634S

(12) **United States Design Patent**
Saboo

(10) **Patent No.:** **US D929,634 S**

(45) **Date of Patent:** **** Aug. 31, 2021**

(54) **FOLDABLE LIGHT**

(71) Applicant: **West Coast Imports, Inc.**, Commerce, CA (US)

(72) Inventor: **Vinay Saboo**, Commerce, CA (US)

(73) Assignee: **WEST COAST IMPORTS, INC.**, Commerce, CA (US)

(**) Term: **15 Years**

(21) Appl. No.: **29/699,315**

(22) Filed: **Jul. 24, 2019**

(51) **LOC (13) Cl.** **26-03**

(52) **U.S. Cl.**
USPC **D26/63**

(58) **Field of Classification Search**
USPC D26/61, 63, 64, 65
CPC F21V 17/02; F21V 21/28; F21V 21/26;
F21V 21/06; F21V 21/00; F21W 2131/30;
F21W 2131/10; F21S 8/024; F21S 6/003;
F21S 8/003; F21S 8/00; F21F 6/00
See application file for complete search history.

(56) **References Cited**

U.S. PATENT DOCUMENTS

D351,678 S *	10/1994	Chen	D26/65
D497,216 S *	10/2004	Lee	D26/60
D498,551 S *	11/2004	Chan	D26/63
D580,574 S *	11/2008	Leslie	D26/63
D590,532 S *	4/2009	Levine	D26/60

D642,315 S *	7/2011	Yu Chung Han	D26/65
D649,672 S *	11/2011	Wang	D26/65
8,152,344 B2 *	4/2012	Gu	F21V 21/26 362/427
D710,527 S *	8/2014	Brown	D26/63
D796,099 S *	8/2017	Bao	D26/63
D797,340 S *	9/2017	Cai	D26/65
D800,939 S *	10/2017	Cai	D26/65

* cited by examiner

Primary Examiner — Brian N. Vinson

(74) *Attorney, Agent, or Firm* — Tarter Krinsky & Drogin LLP

(57) **CLAIM**

The ornamental design for a foldable light, as shown and described.

DESCRIPTION

FIG. 1 is a perspective view of a foldable light in a folded configuration;
FIG. 2 is a perspective view of the foldable light in an unfolded configuration;
FIG. 3 is a front view of the foldable light in the folded configuration;
FIG. 4 is a rear view thereof;
FIG. 5 is a first side view thereof;
FIG. 6 is a second side view thereof;
FIG. 7 is a top view thereof; and,
FIG. 8 is a bottom view thereof.

The broken lines shown in the figures are environmental and form no part of the claimed design.

1 Claim, 5 Drawing Sheets

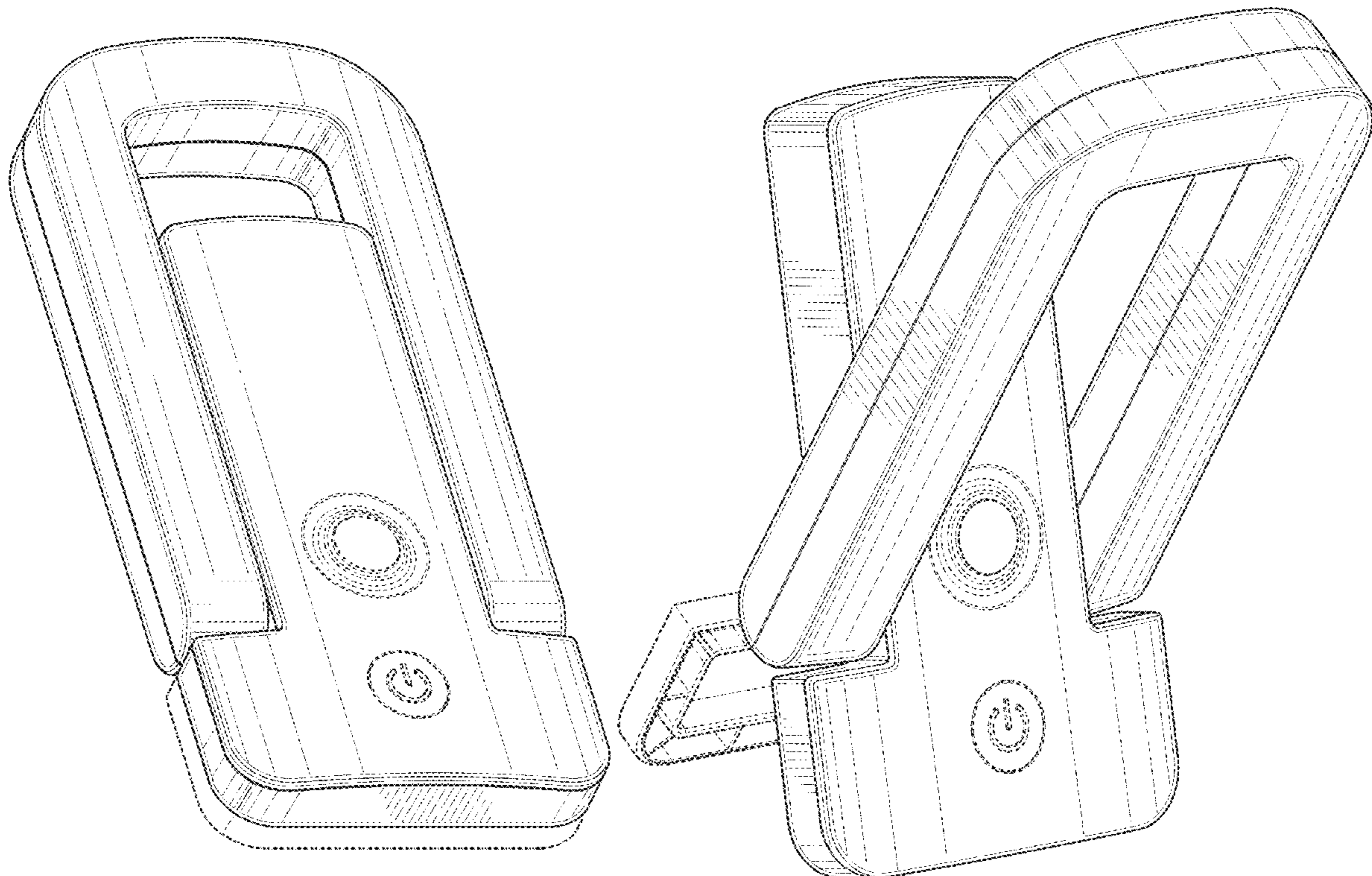

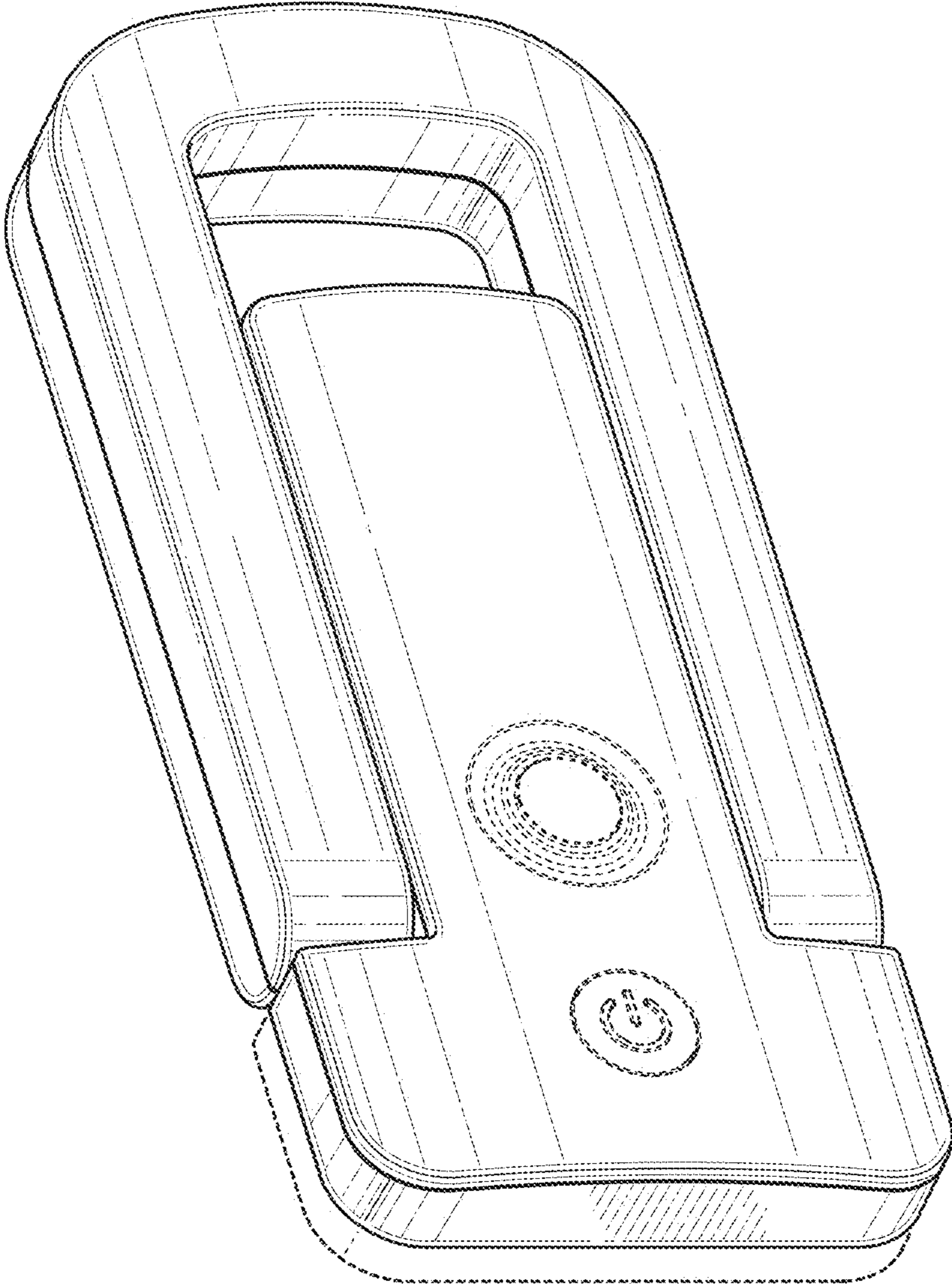

FIG. 1

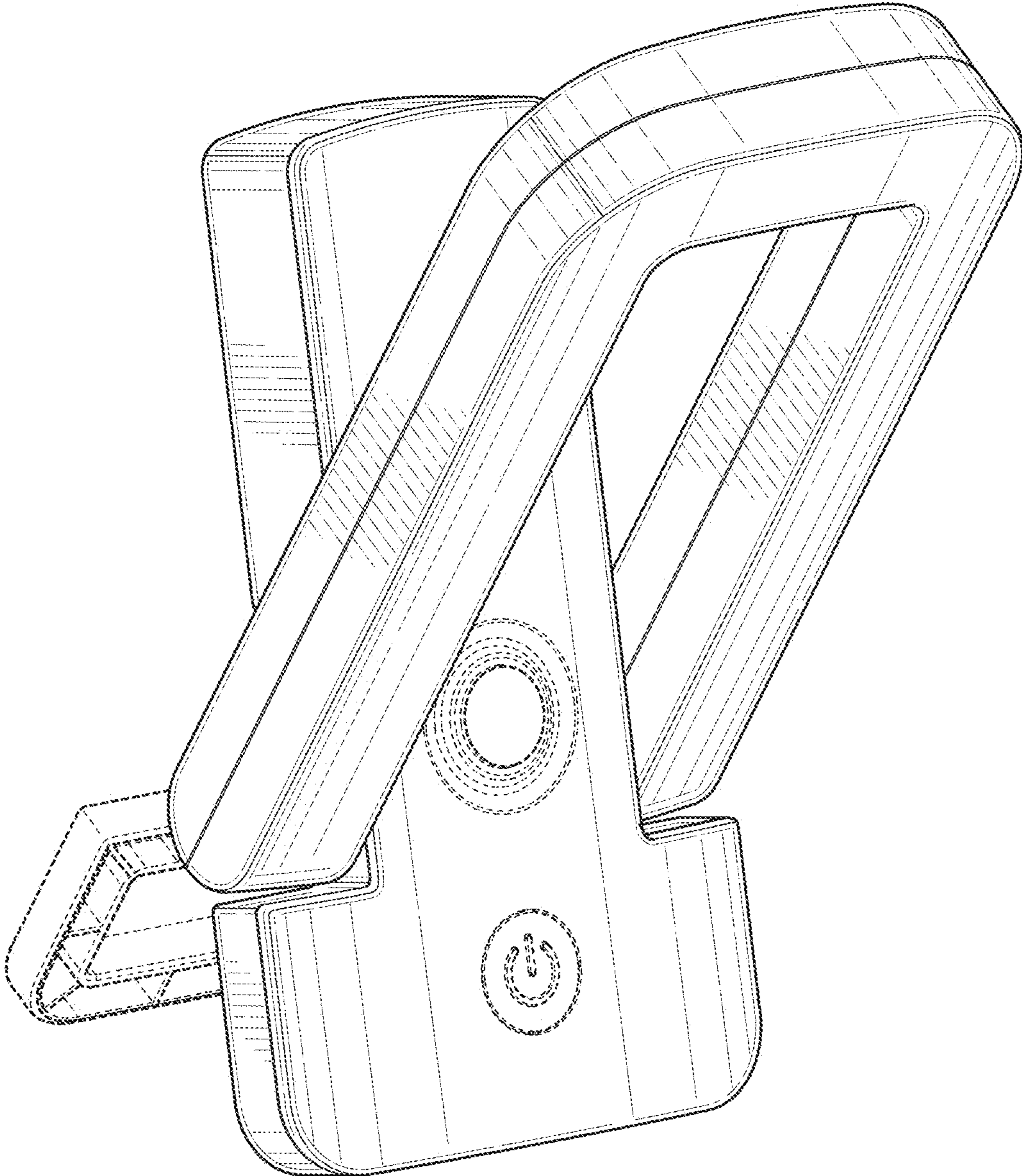

FIG. 2

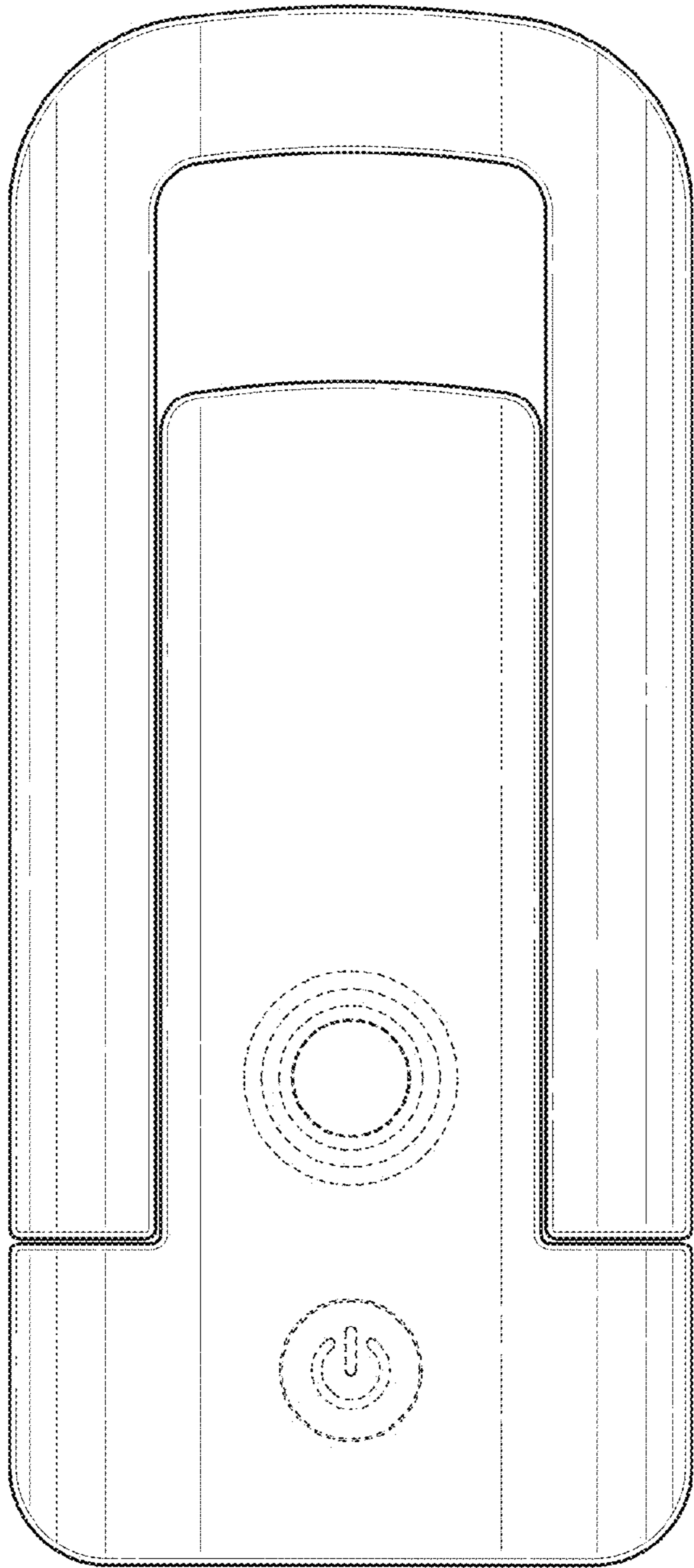

FIG. 3

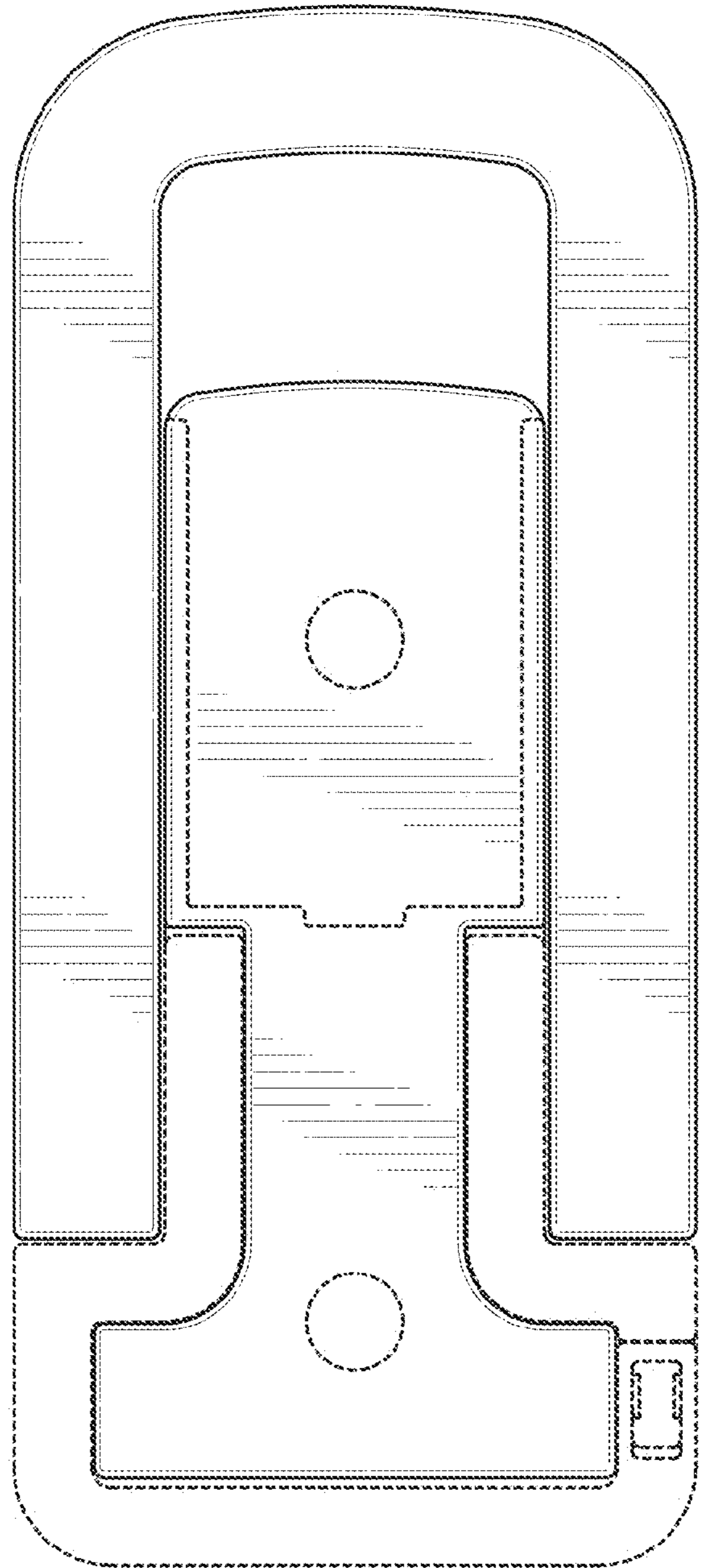

FIG. 4

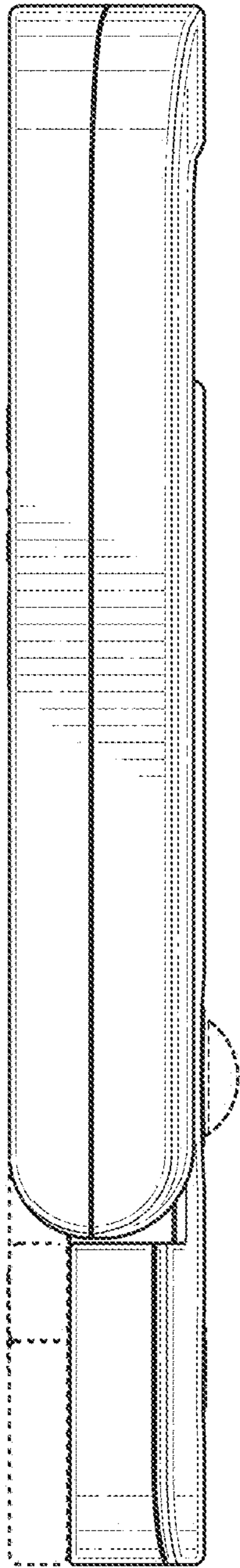

FIG. 5

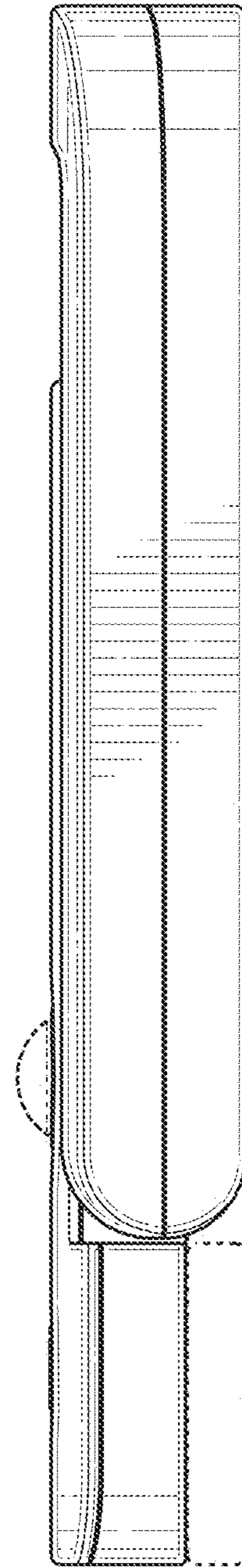

FIG. 6

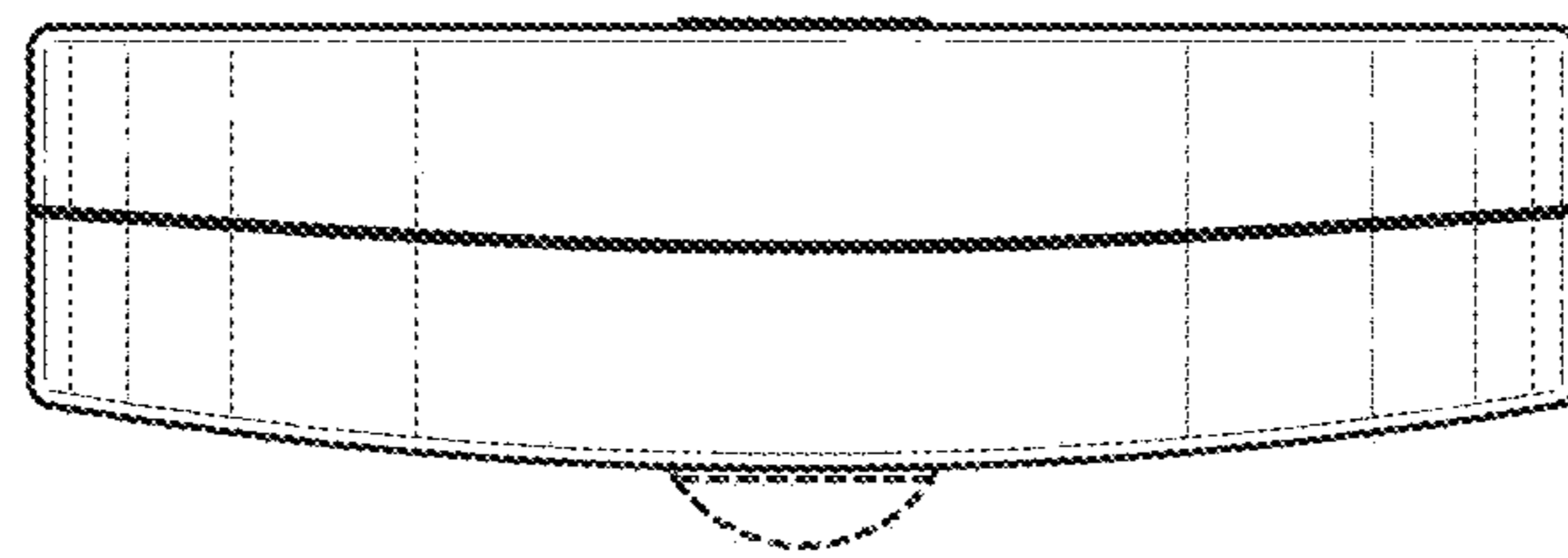

FIG. 7

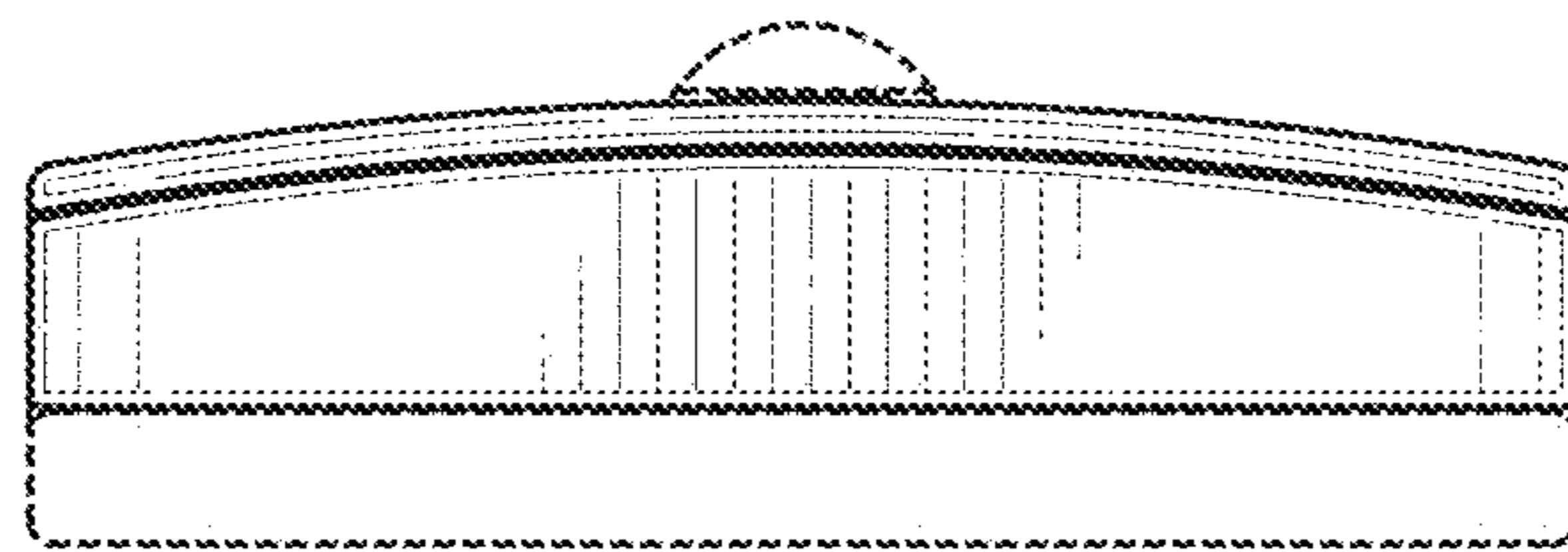

FIG. 8