



US00D929618S

(12) **United States Design Patent** (10) **Patent No.:** **US D929,618 S**  
**Kreso** (45) **Date of Patent:** **\*\* Aug. 31, 2021**

(54) **DECORATIVE LIGHT FIXTURE**  
(71) Applicant: **Samira Kreso**, Chicago, IL (US)  
(72) Inventor: **Samira Kreso**, Chicago, IL (US)  
(\*\*) Term: **15 Years**  
(21) Appl. No.: **29/676,576**  
(22) Filed: **Jan. 11, 2019**  
(51) **LOC (13) Cl.** ..... **26-04**  
(52) **U.S. Cl.**  
USPC ..... **D26/4**  
(58) **Field of Classification Search**  
USPC ..... D26/1-4  
CPC ..... H01R 5/00; H01R 13/46; H01R 13/514;  
H01R 31/02; H01R 31/048; H01J 5/00;  
H01J 5/16; H01J 1/02; H01J 15/00; H01J  
5/48; H01J 5/50; H01J 19/54; F21V 5/00;  
F21K 9/00; F21K 13/00  
See application file for complete search history.

(56) **References Cited**

U.S. PATENT DOCUMENTS

4,296,459	A	10/1981	Deluca	
4,309,743	A	1/1982	Martin	
4,894,757	A	1/1990	Frusha et al.	
5,876,109	A	3/1999	Scalco	
D866,387	S *	11/2019	Pan	D11/121
2001/0030862	A1	10/2001	Simms	
2007/0153497	A1	7/2007	Chang	
2009/0103287	A1	4/2009	Medley	
2010/0271815	A1	10/2010	Gomez	

2013/0063932 A1 3/2013 Nussbaum et al.  
\* cited by examiner  
*Primary Examiner* — Marcus A Jackson  
(74) *Attorney, Agent, or Firm* — Burriss Law, PLLC  
(57) **CLAIM**  
The ornamental design for a decorative light fixture, as shown and described.

**DESCRIPTION**

FIG. 1 is a top perspective view of a decorative light fixture illustrating an embodiment of our new design;  
FIG. 2 is an exploded view thereof in a dissembled state;  
FIG. 3 is a front view thereof;  
FIG. 4 is a rear view thereof;  
FIG. 5 is a left side view thereof;  
FIG. 6 is a right side view thereof;  
FIG. 7 is a top plan view thereof;  
FIG. 8 is a bottom plan view thereof;  
FIG. 9 is a front view of a battery holder of the decorative light fixture in a dissembled state;  
FIG. 10 is a rear view of the battery holder of FIG. 9;  
FIG. 11 is a side view of the battery holder of FIG. 9;  
FIG. 12 illustrates a first exemplary use of the decorative light fixture;  
FIG. 13 illustrates a second first exemplary use of the decorative light fixture;  
FIG. 14 illustrates a third exemplary use of the decorative light fixture; and,  
FIG. 15 illustrates a fourth exemplary use of the decorative light fixture.  
The broken line representations in the figures show unclaimed environment, and thus form no part of the claimed design.

**1 Claim, 7 Drawing Sheets**

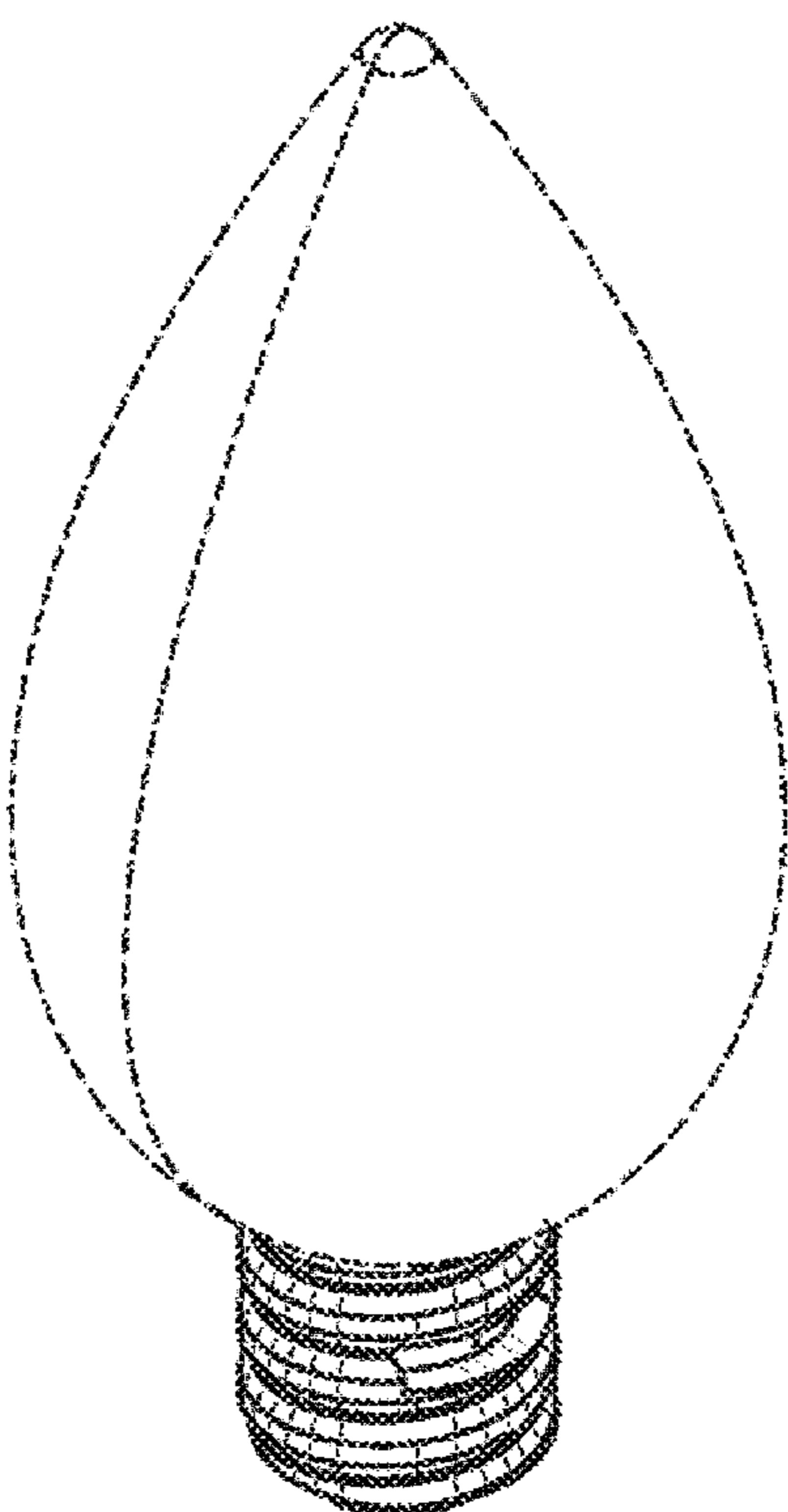

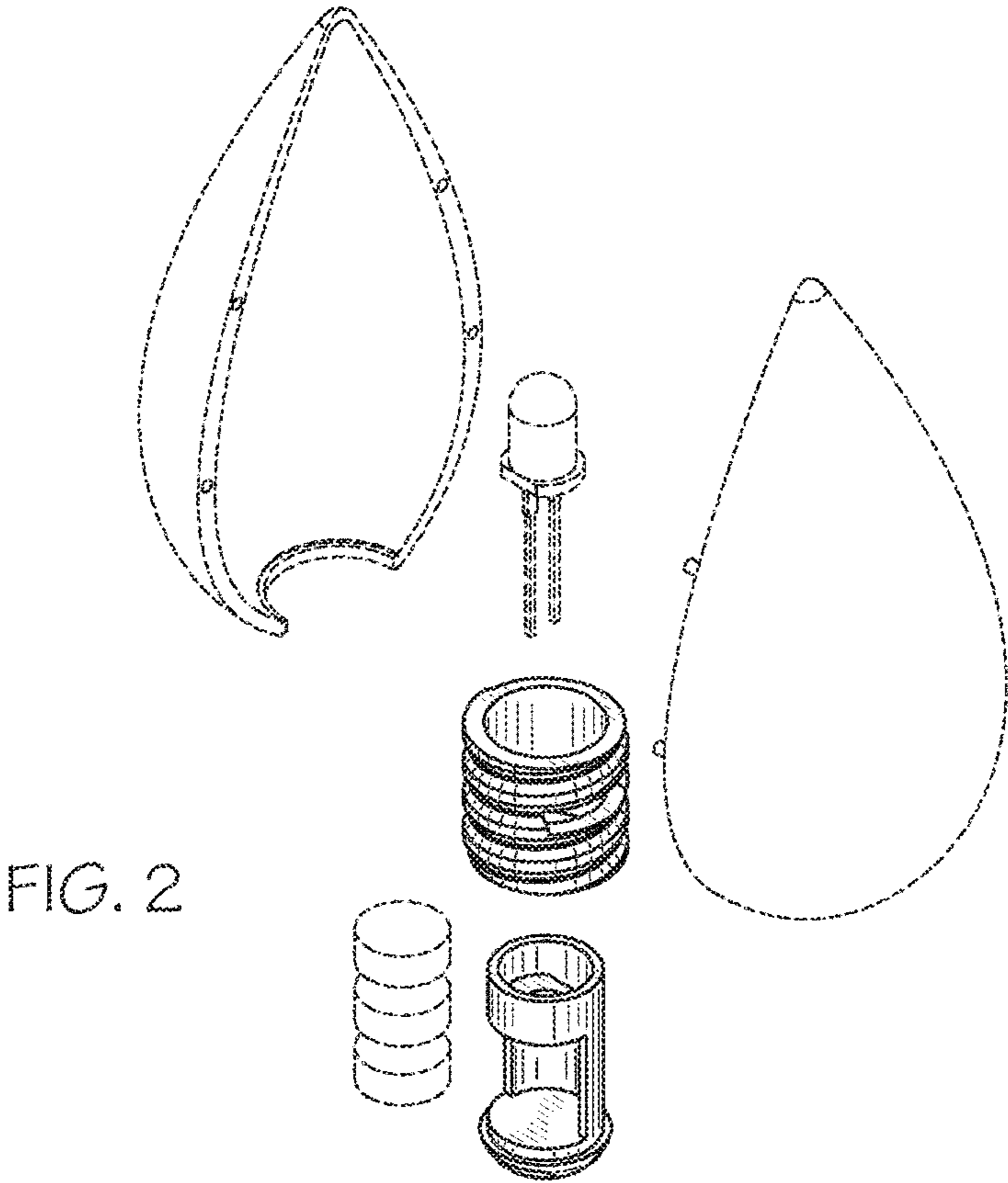
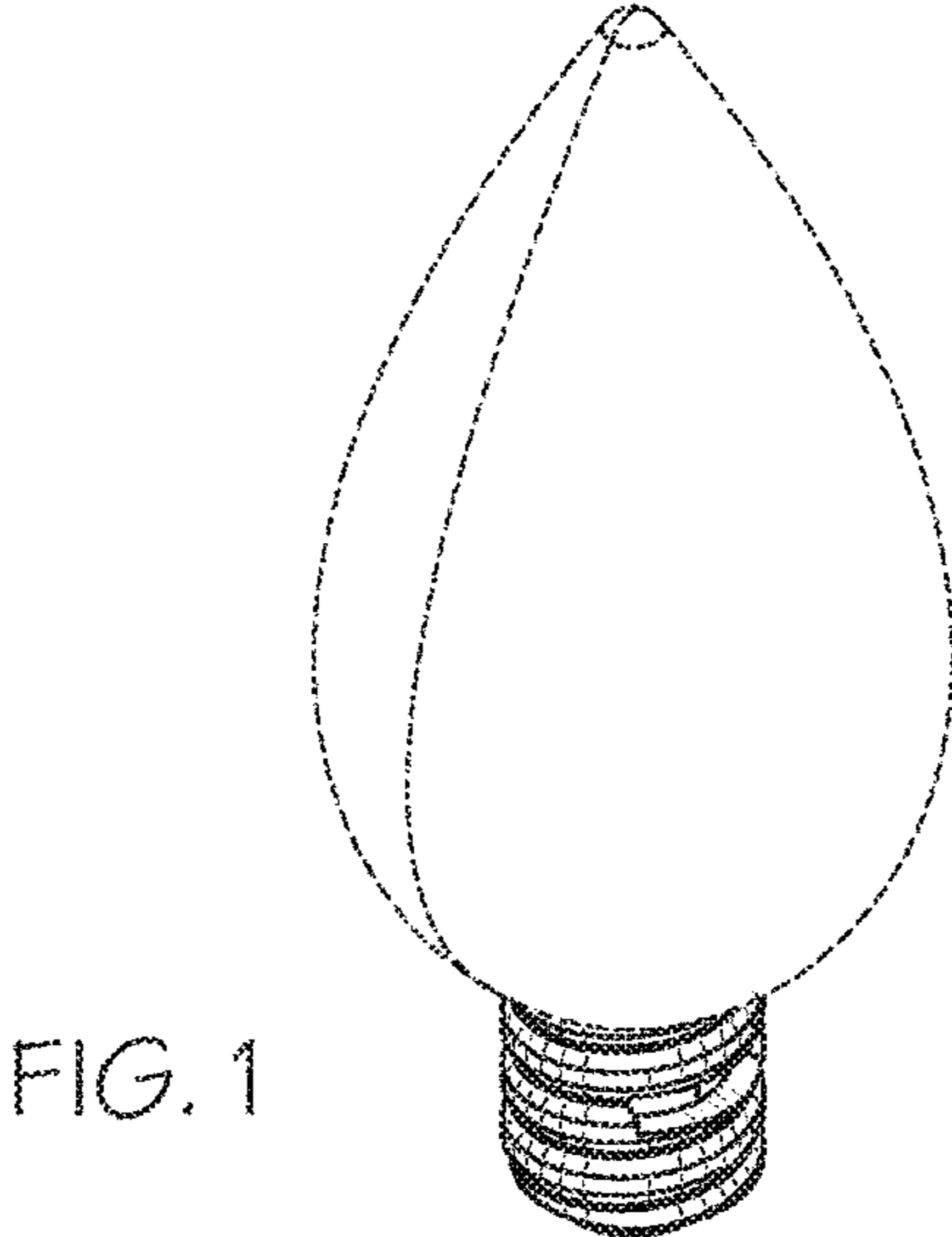

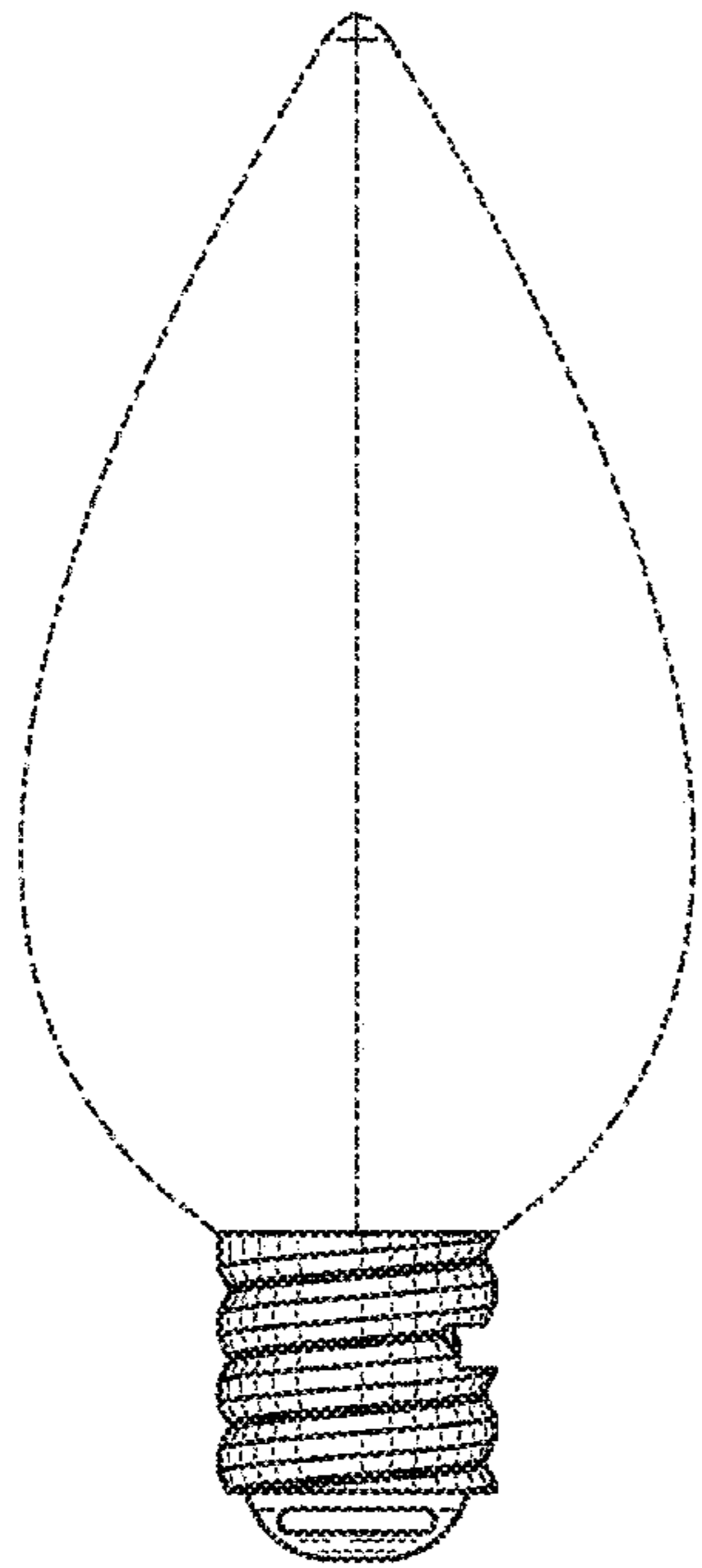

FIG. 3

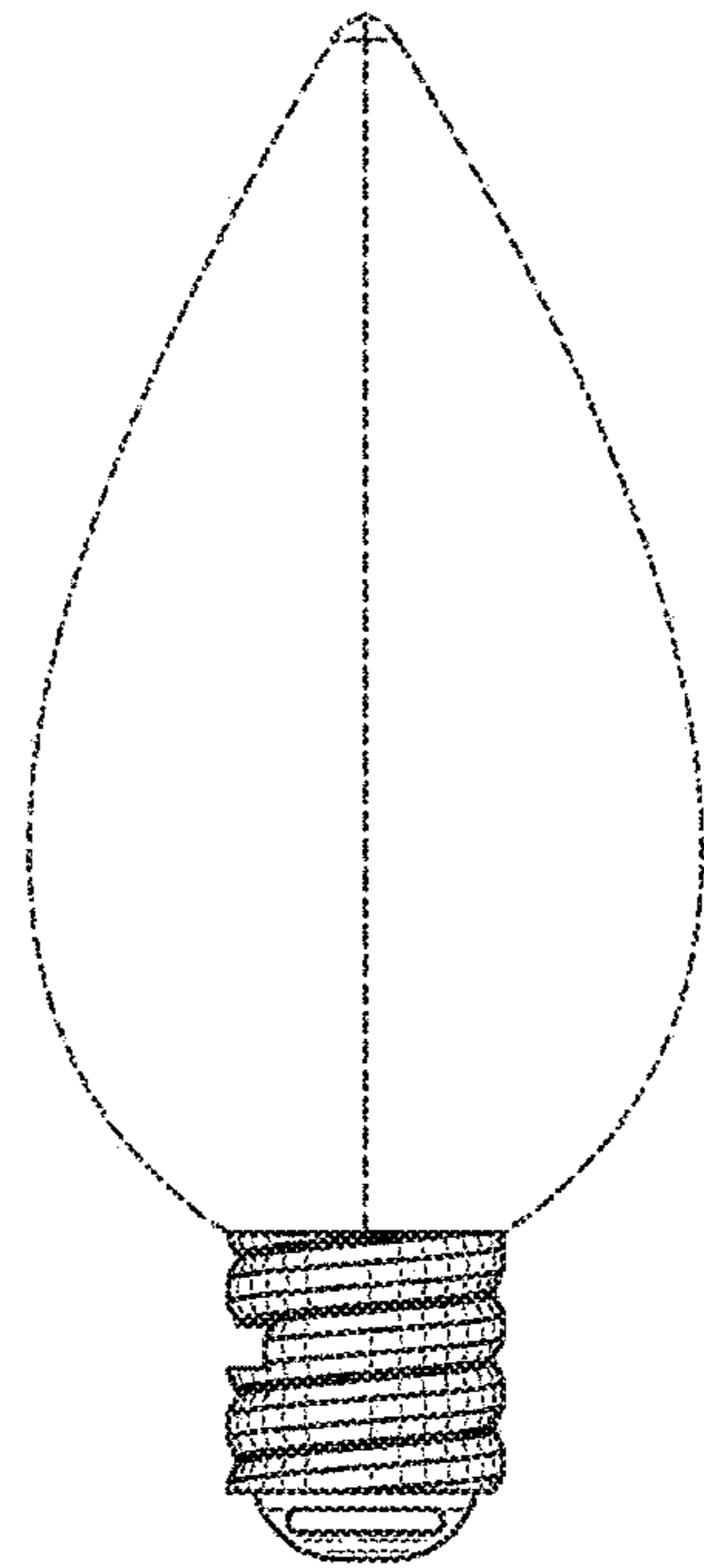

FIG. 4

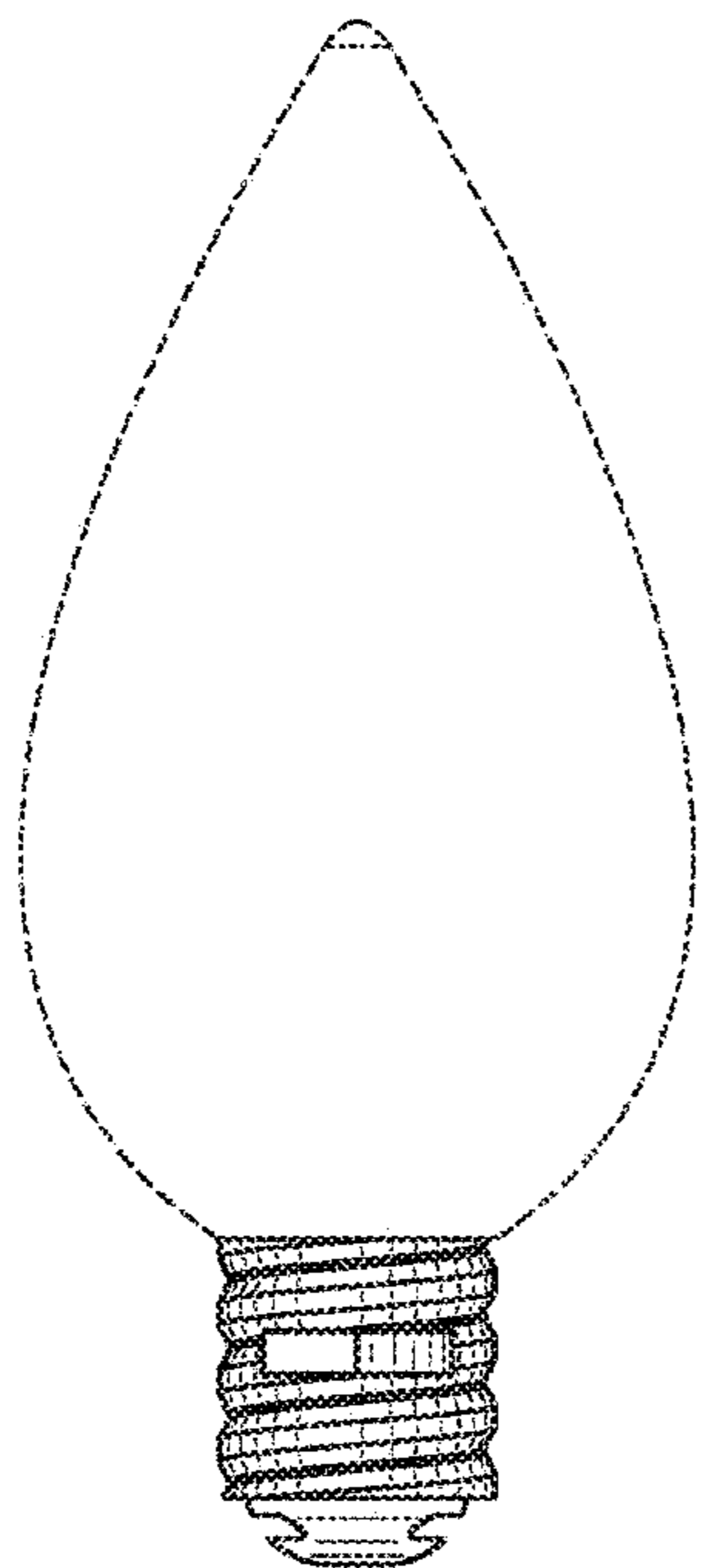

FIG. 5

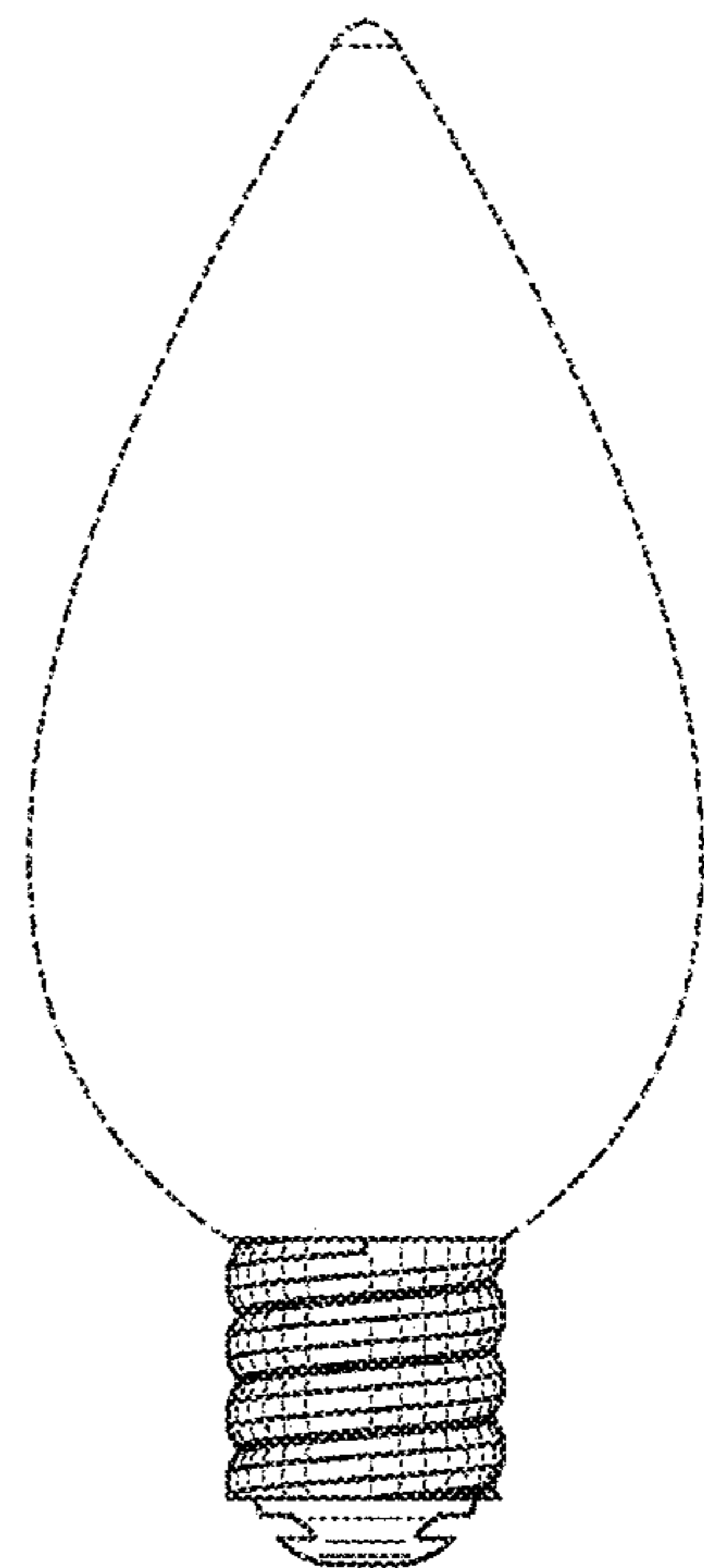

FIG. 6

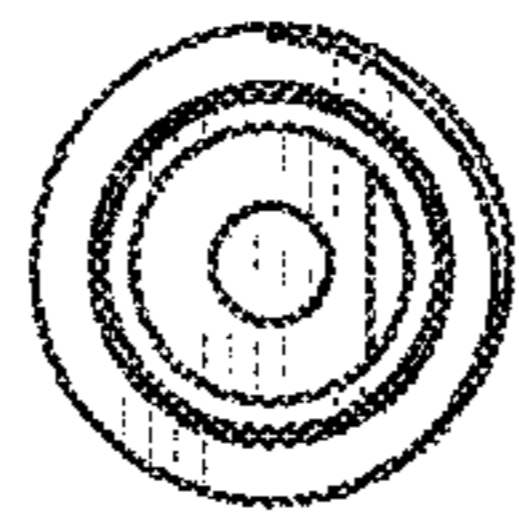

FIG. 7

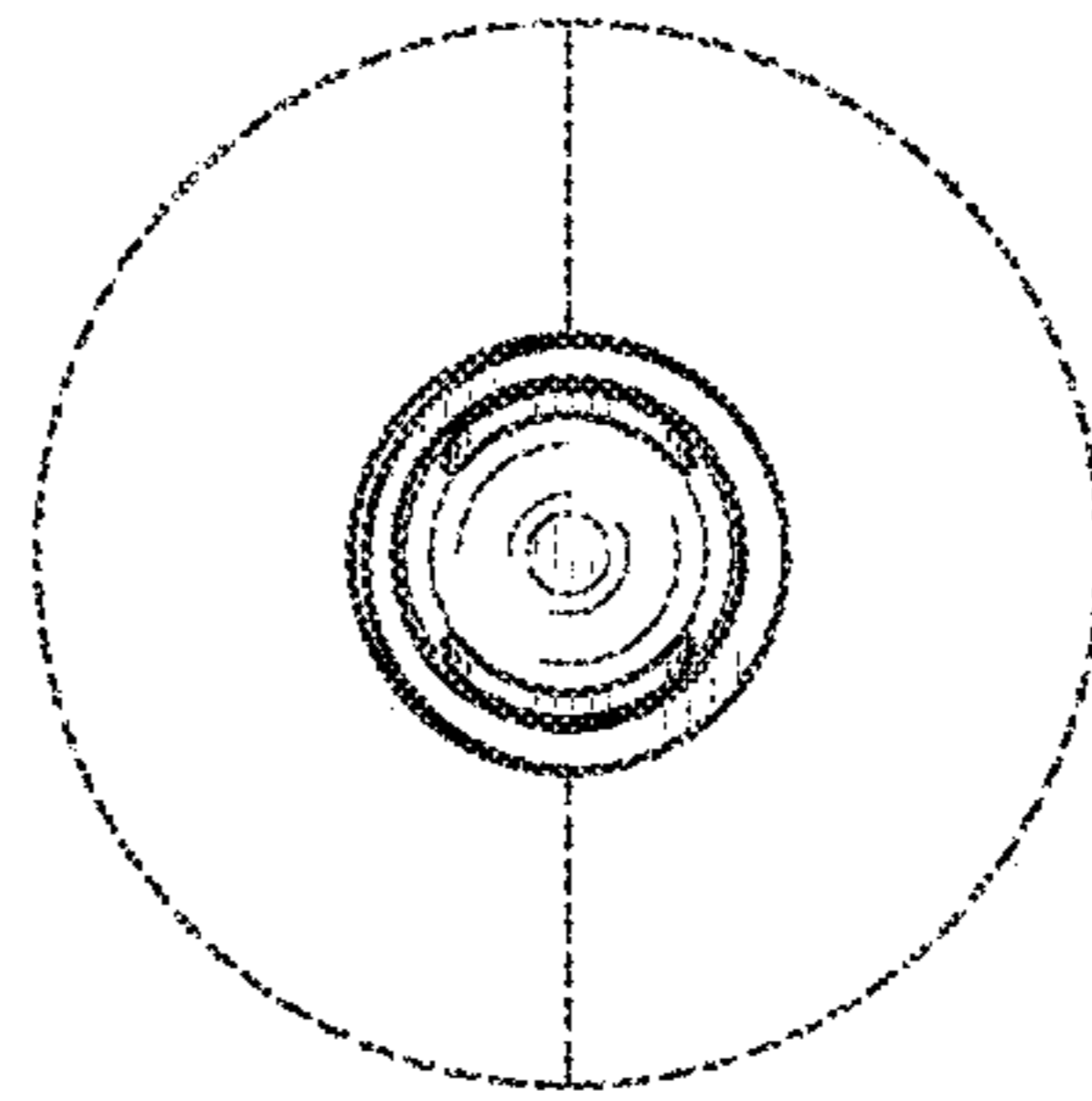

FIG. 8

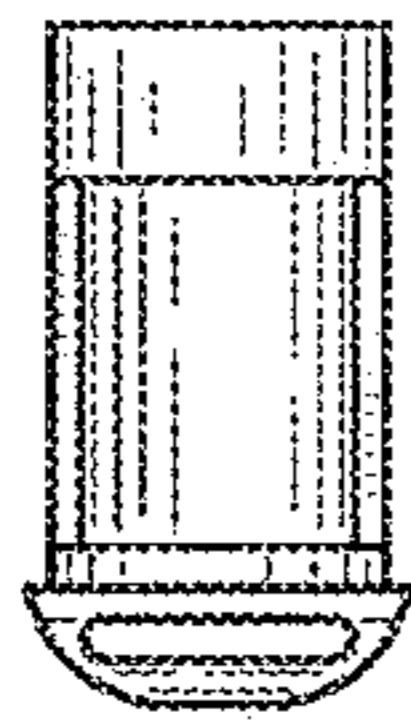

FIG. 9

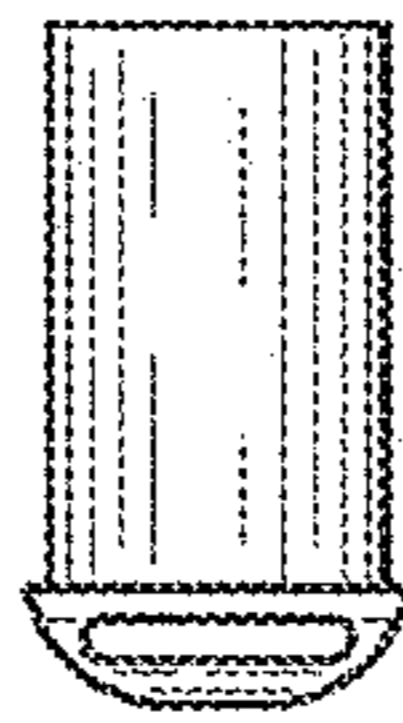

FIG. 10

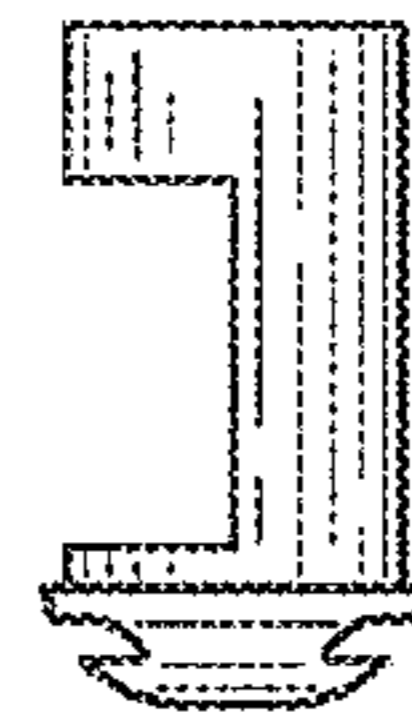

FIG. 11

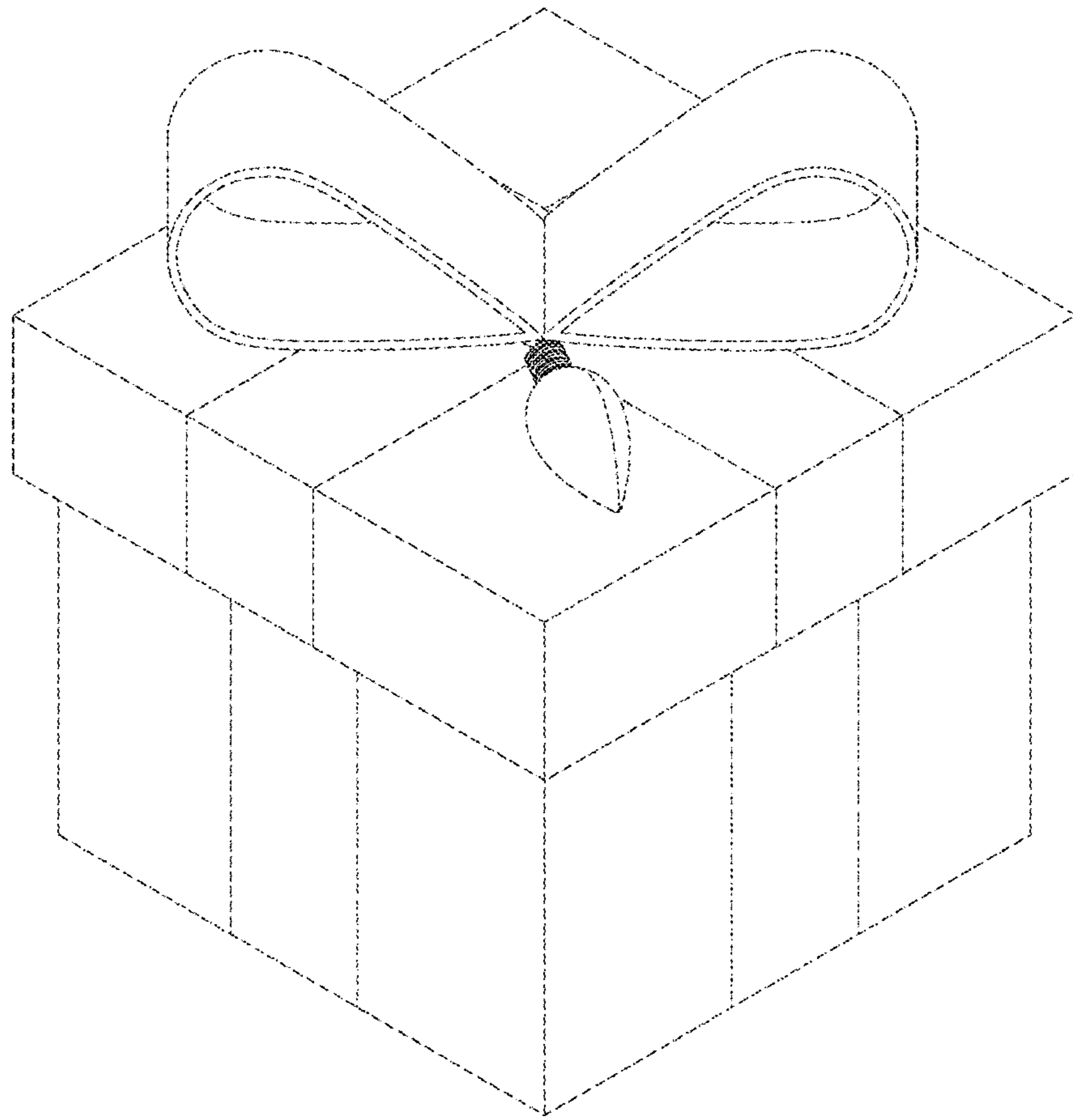

FIG. 12

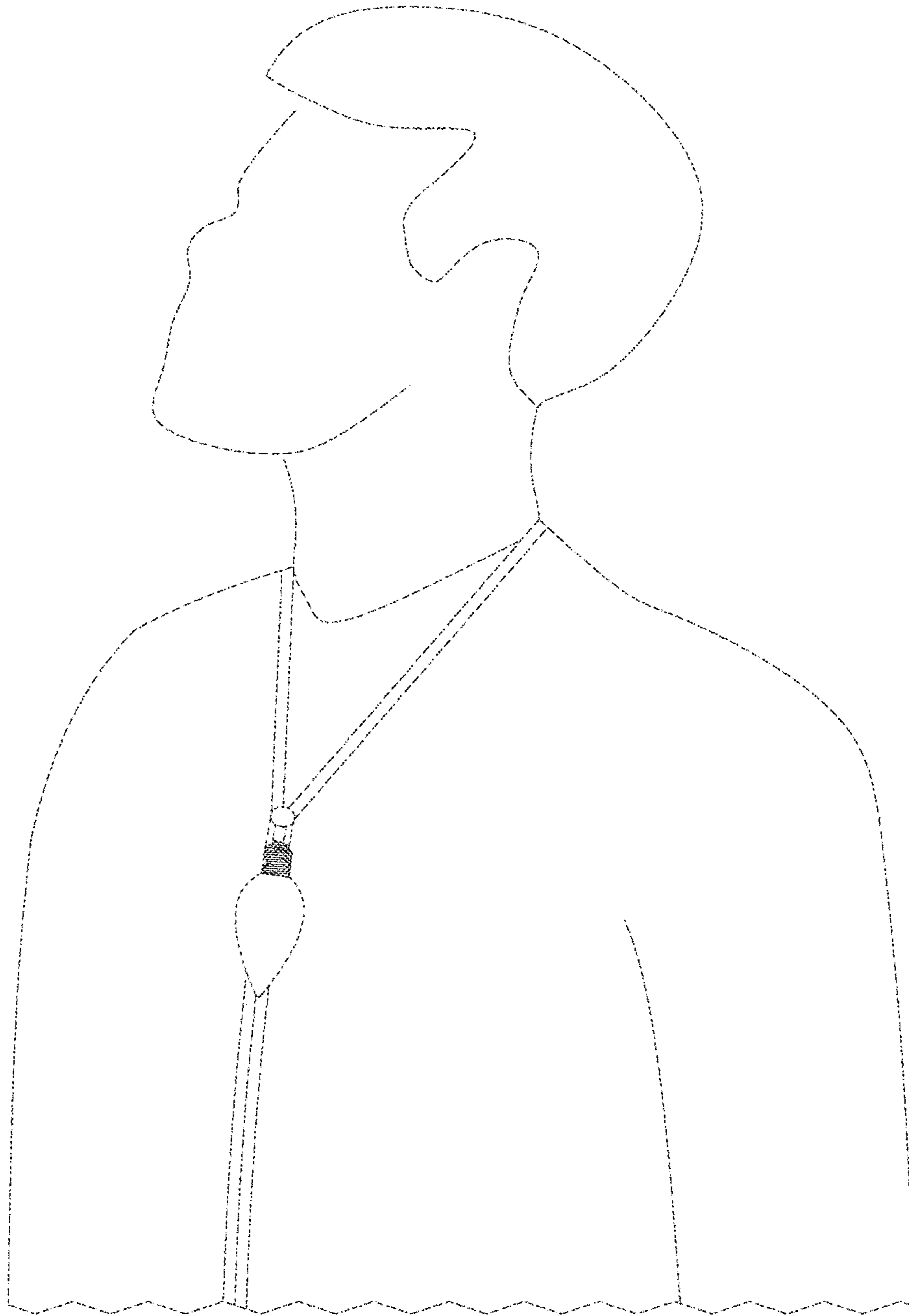

FIG. 13

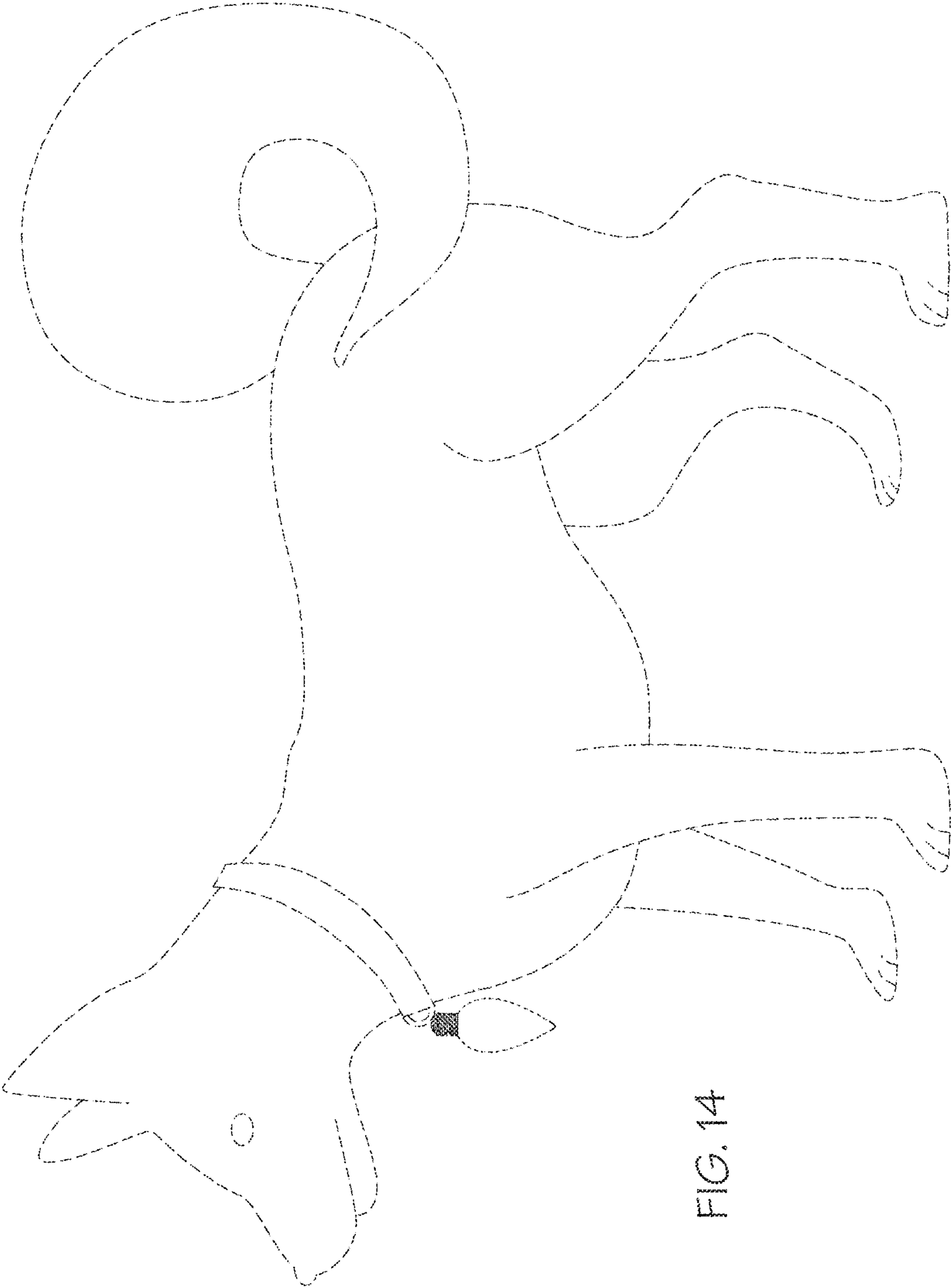

FIG. 14

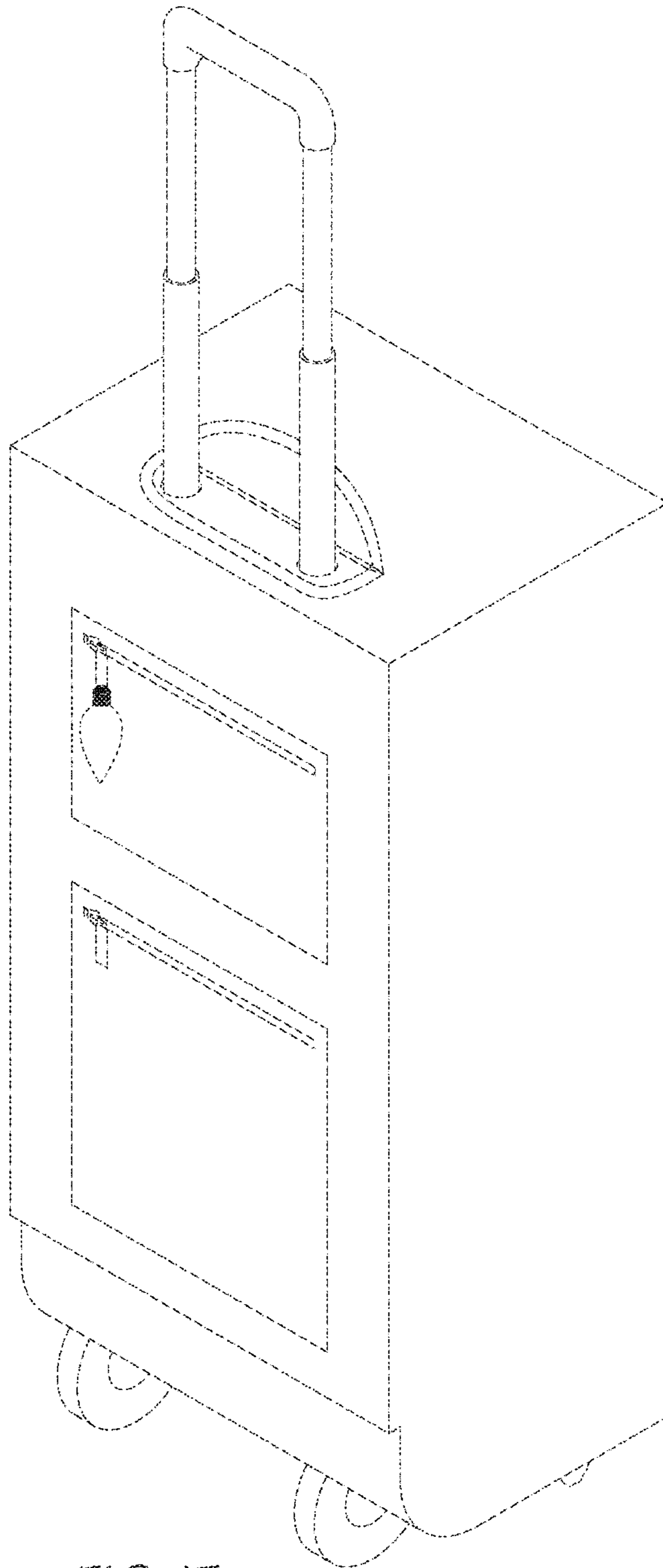

FIG. 15