



US00D929545S

(12) **United States Design Patent**  
**Spangler**

(10) **Patent No.:** **US D929,545 S**

(45) **Date of Patent:** **\*\* Aug. 31, 2021**

(54) **FAUCET**

D667,084 S \* 9/2012 Berger ..... D23/238  
D883,442 S \* 5/2020 Massaud ..... D23/242  
D912,211 S \* 3/2021 Liu ..... D23/238

(71) Applicant: **DELTA FAUCET COMPANY,**  
Indianapolis, IN (US)

\* cited by examiner

(72) Inventor: **Anthony G. Spangler,** Indianapolis, IN  
(US)

*Primary Examiner* — Robert A Delehanty

(73) Assignee: **DELTA FAUCET COMPANY,**  
Indianapolis, IN (US)

(74) *Attorney, Agent, or Firm* — Nirav D. Parikh; Edgar  
A. Zarins

(\*\*) Term: **15 Years**

(57) **CLAIM**

(21) Appl. No.: **29/693,246**

The ornamental design for a faucet, as shown and described.

(22) Filed: **May 31, 2019**

(51) **LOC (13) Cl.** ..... **23-01**

(52) **U.S. Cl.**

USPC ..... **D23/257**

(58) **Field of Classification Search**

USPC ..... D23/255, 257, 238-243, 250, 252, 254

CPC ..... E03C 1/042

See application file for complete search history.

**DESCRIPTION**

FIG. 1 is a front perspective view of a faucet showing my  
new design;  
FIG. 2 is a rear perspective view thereof;  
FIG. 3 is a front elevational view thereof;  
FIG. 4 is a left side view thereof;  
FIG. 5 is a rear view thereof;  
FIG. 6 is a right side view thereof;  
FIG. 7 is a top plan view thereof; and,  
FIG. 8 is a bottom view thereof.

(56) **References Cited**

**U.S. PATENT DOCUMENTS**

D547,831 S \* 7/2007 Williams ..... D23/255  
D609,309 S \* 2/2010 Fritz ..... D23/252

**1 Claim, 4 Drawing Sheets**

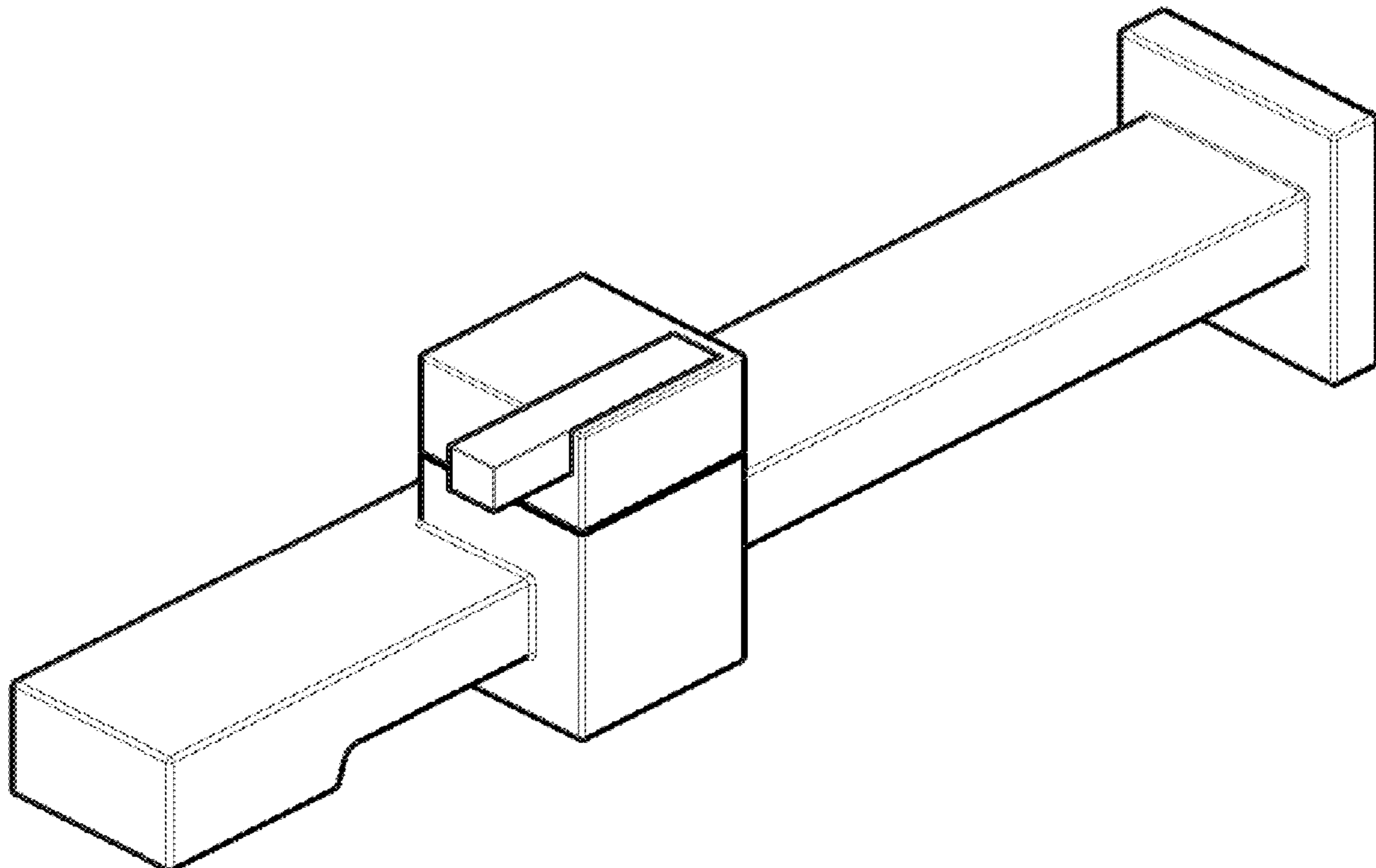

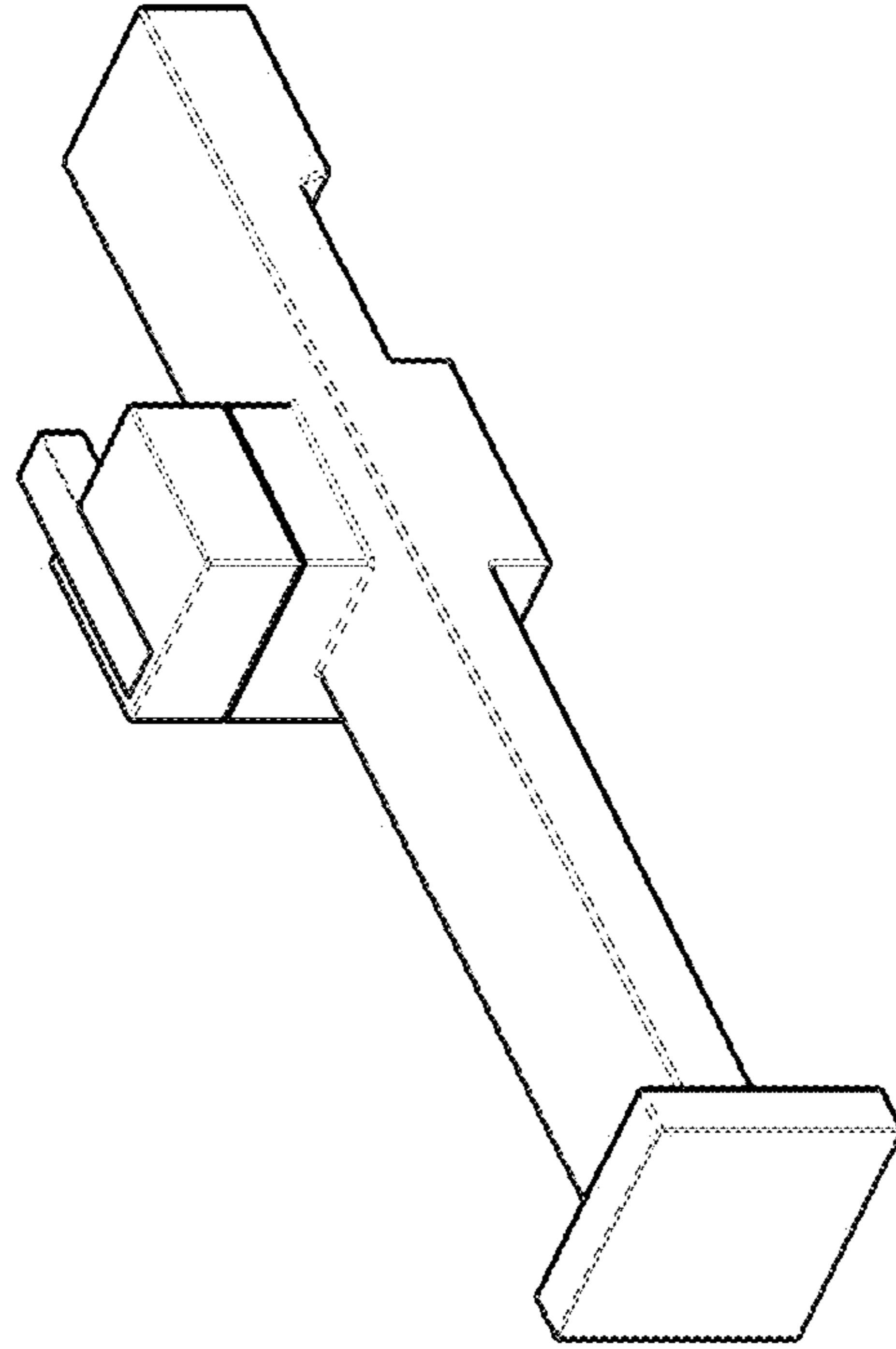

FIG-2

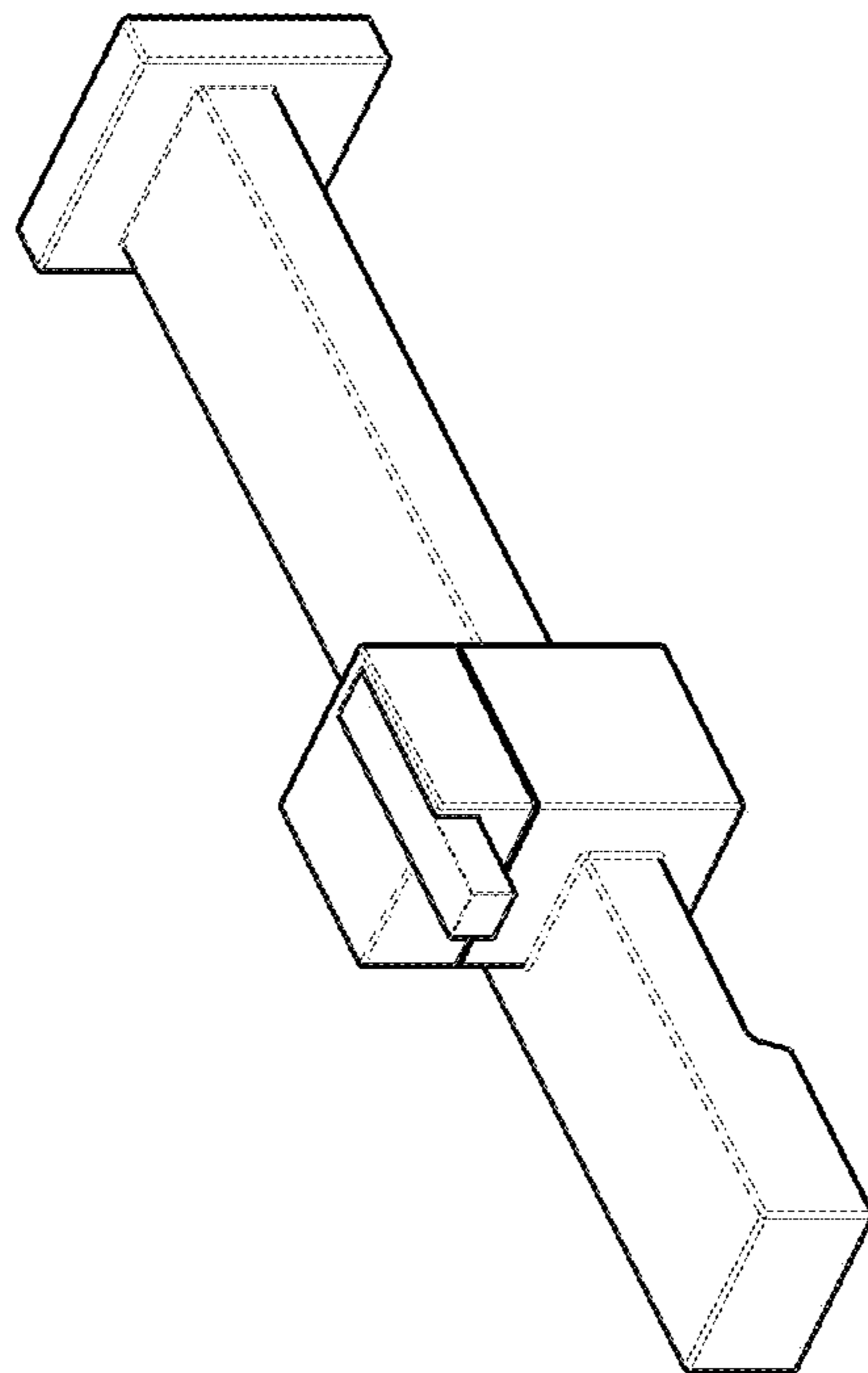

FIG-1

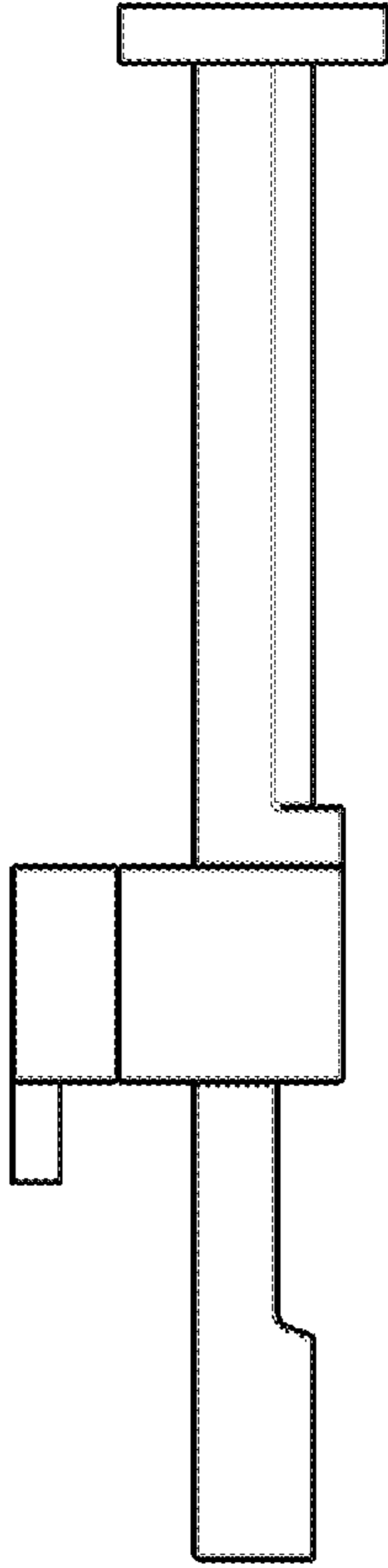

FIG-4

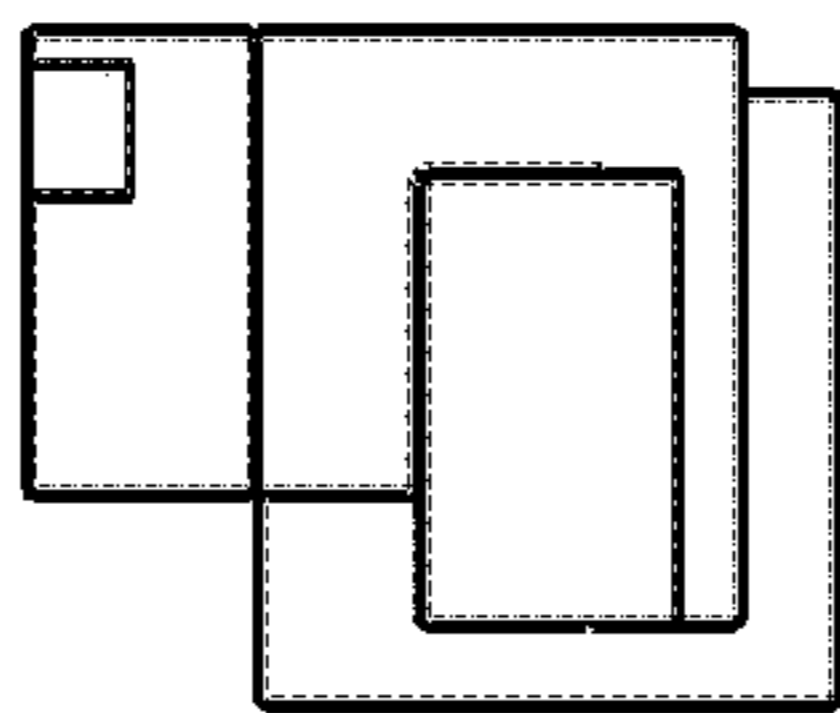

FIG-3

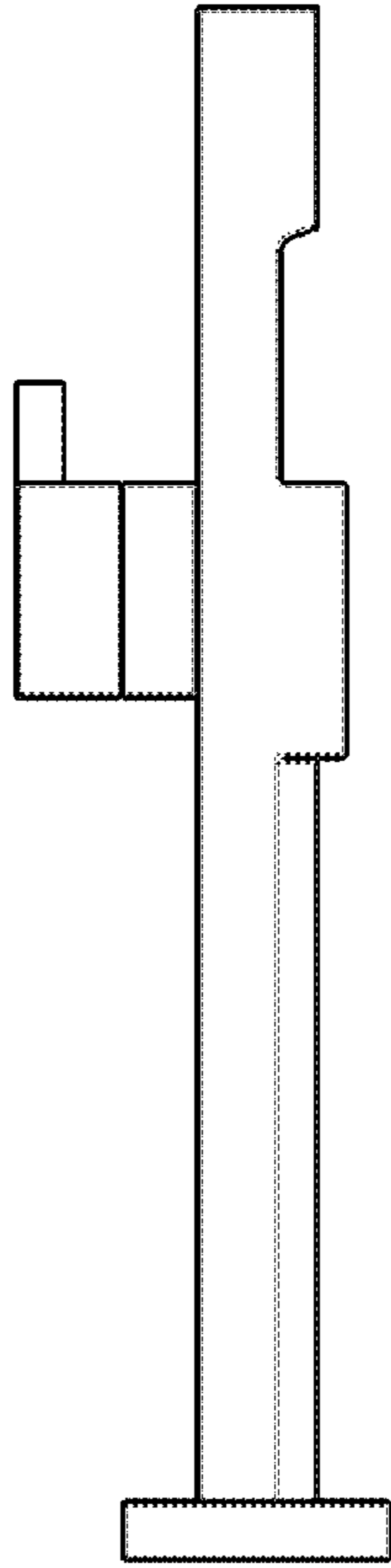

FIG-6

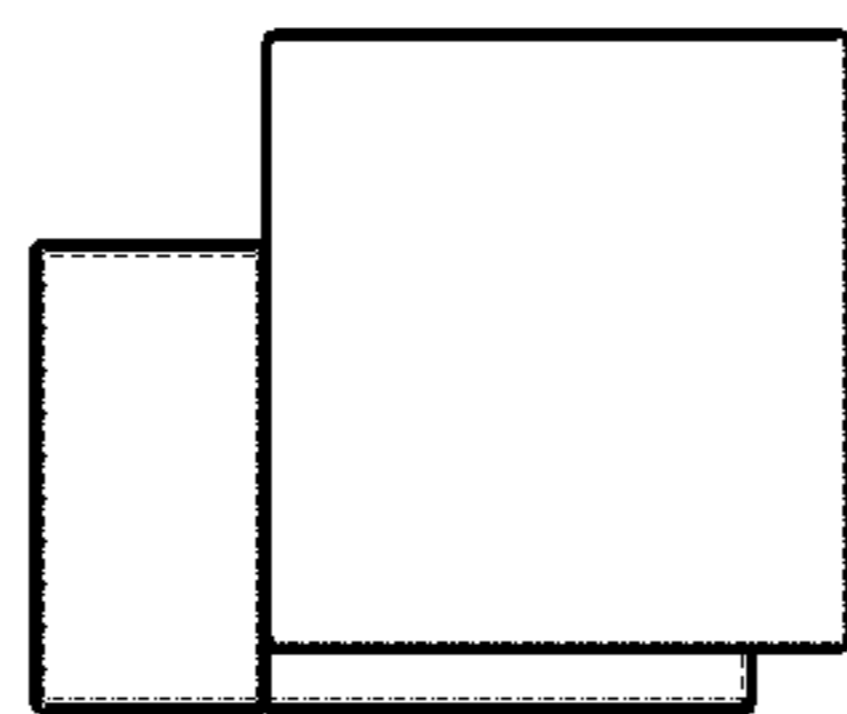

FIG-5

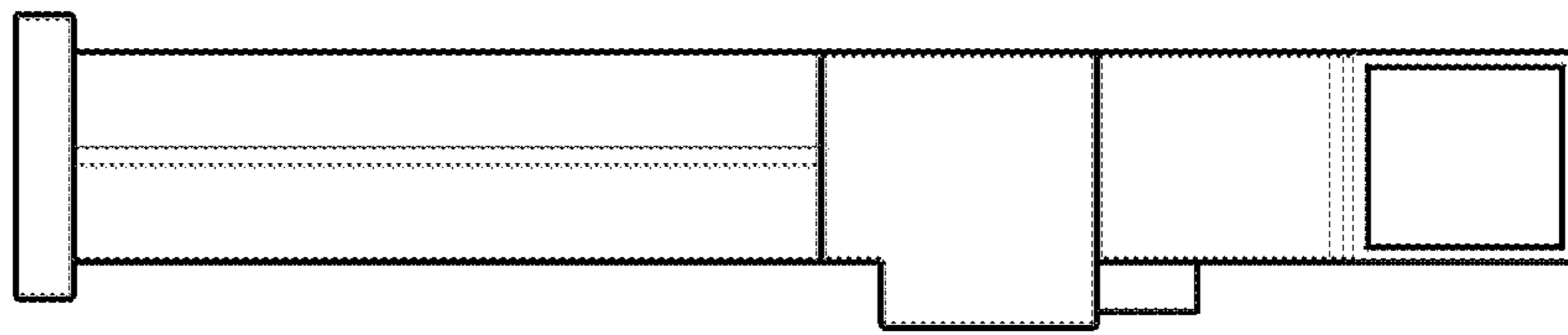

FIG-8

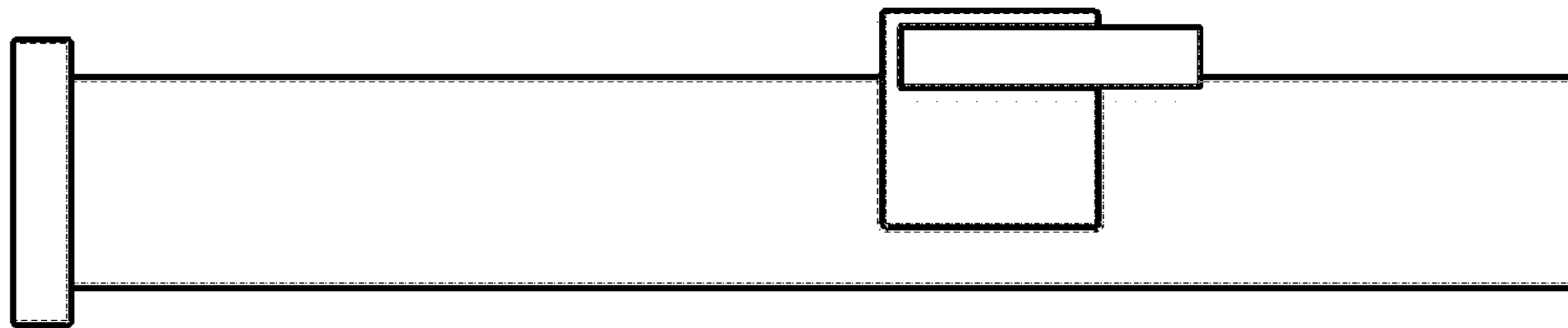

FIG-7