



US00D929535S

(12) **United States Design Patent** (10) **Patent No.:** **US D929,535 S**  
**Healy** (45) **Date of Patent:** **\*\* Aug. 31, 2021**

(54) **SPRINKLER**

(71) Applicant: **Senninger Irrigation, Inc.**, Clermont, FL (US)

(72) Inventor: **Mark Healy**, Orlando, FL (US)

(73) Assignee: **Senninger Irrigation, Inc.**, Clermont, FL (US)

(\*\*) Term: **15 Years**

(21) Appl. No.: **29/727,947**

(22) Filed: **Mar. 13, 2020**

(51) **LOC (13) Cl.** ..... **23-01**

(52) **U.S. Cl.**  
USPC ..... **D23/214**

(58) **Field of Classification Search**  
USPC ..... D23/213-215, 223, 224, 225, 226, 229, D23/230

CPC ..... A61H 9/0021; A61H 33/00; B05B 1/00; B05B 1/14; B05B 1/185; B05B 1/08; B05B 1/02; B05B 1/26; B05B 12/002; B05B 1/18; B05B 9/01

See application file for complete search history.

(56) **References Cited**

**U.S. PATENT DOCUMENTS**

2,848,276	A	8/1958	Clearman	
3,009,648	A	11/1961	Hait	
3,034,728	A	5/1962	Hruby	
3,091,400	A	5/1963	Claude	
3,312,400	A	4/1967	Clearman	
3,682,388	A	8/1972	Ferguson	
3,799,453	A	3/1974	Hart	
D253,364	S	* 11/1979	McFadden	239/222.21
D260,169	S	* 8/1981	Vikre	D23/214

(Continued)

**OTHER PUBLICATIONS**

Drip Depot Senninger Xcel-Wobbler. May 13, 2018, Amazon.com, Apr. 8, 2021. URL: <https://www.amazon.com/Senninger-Xcel-Wobbler-Angle-Nozzle-10-Turquoise/dp/B078X125NF> (Year: 2018).\*

*Primary Examiner* — Jack Reickel

*Assistant Examiner* — Keith J Wilson

(74) *Attorney, Agent, or Firm* — Knobbe Martens Olson & Bear LLP

(57) **CLAIM**

The ornamental design for a sprinkler, as shown and described.

**DESCRIPTION**

FIG. 1 is a top and side perspective view of a sprinkler embodying a new design;  
 FIG. 2 is a bottom and side perspective view of the sprinkler of FIG. 1;  
 FIG. 3 is a side view of the sprinkler of FIG. 1;  
 FIG. 4 is another side view of the sprinkler of FIG. 1 opposite the side view of FIG. 3;  
 FIG. 5 is another side view of the sprinkler of FIG. 1;  
 FIG. 6 is another side view of the sprinkler of FIG. 1 opposite the side view of FIG. 5;  
 FIG. 7 is a top view of the sprinkler of FIG. 1;  
 FIG. 8 is a bottom view of the sprinkler of FIG. 1;  
 FIG. 9 is a top and side perspective view of a sprinkler embodying a new design;  
 FIG. 10 is a bottom and side perspective view of the sprinkler of FIG. 9;  
 FIG. 11 is a side view of the sprinkler of FIG. 9;  
 FIG. 12 is another side view of the sprinkler of FIG. 9 opposite the side view of FIG. 11;  
 FIG. 13 is another side view of the sprinkler of FIG. 9;  
 FIG. 14 is another side view of the sprinkler of FIG. 9 opposite the side view of FIG. 13;  
 FIG. 15 is a top view of the sprinkler of FIG. 9; and,  
 FIG. 16 is a bottom view of the sprinkler of FIG. 9.  
 Broken lines are used to illustrate features of the sprinkler which form no part of the claimed design.

**1 Claim, 16 Drawing Sheets**

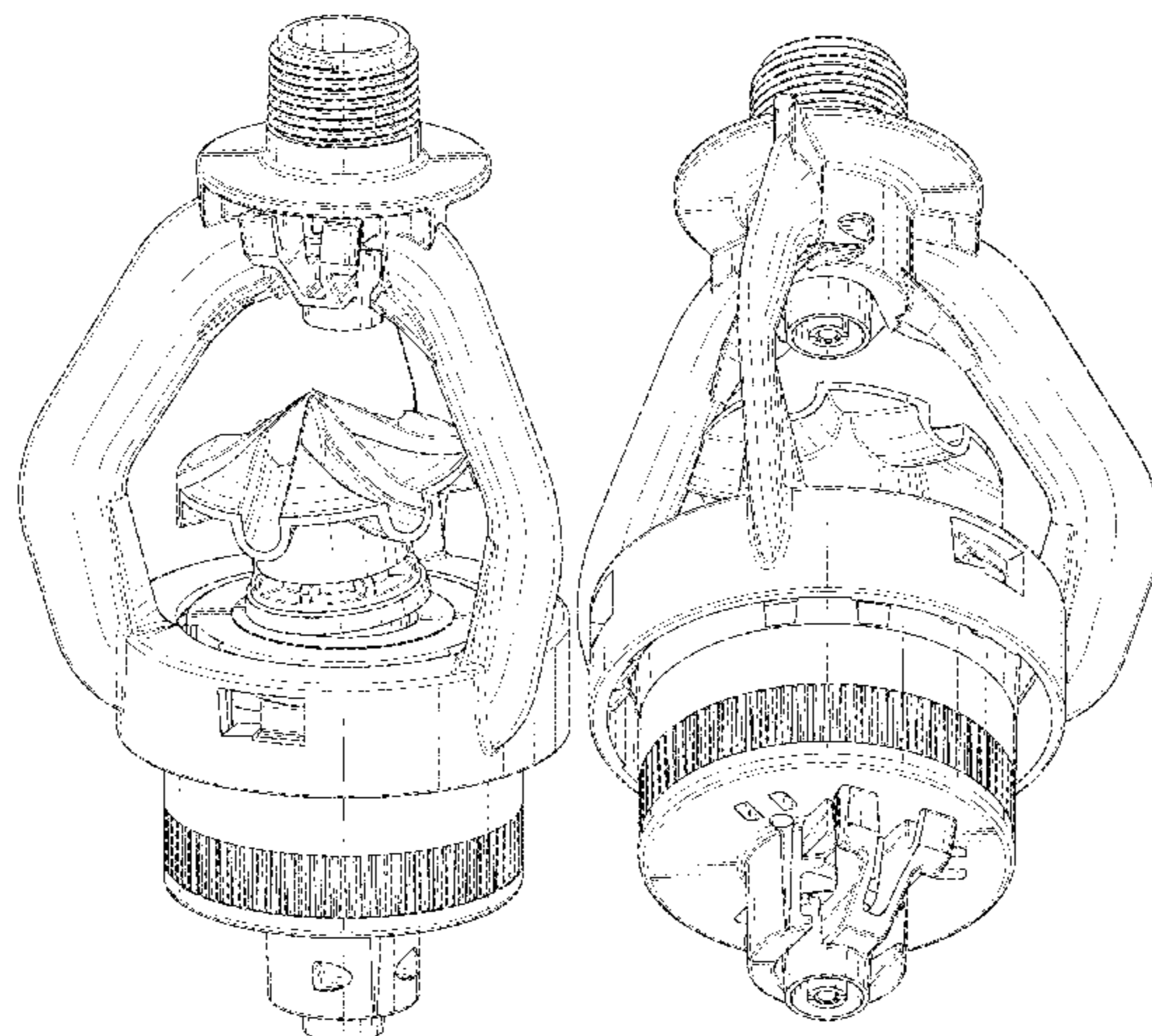

(56)

References Cited

U.S. PATENT DOCUMENTS

4,356,972 A	11/1982	Vikre	7,395,977 B2	7/2008	Pinch et al.
4,398,666 A	8/1983	Hunter	7,562,833 B2	7/2009	Perkins et al.
4,487,368 A	12/1984	Clearman	7,770,821 B2	8/2010	Pinch
4,773,594 A	9/1988	Clearman	7,942,345 B2	5/2011	Sesser et al.
4,796,811 A	1/1989	Davisson	8,556,196 B2	10/2013	Lawyer et al.
RE33,823 E	2/1992	Nelson et al.	8,584,969 B2	11/2013	Drechsel
5,234,169 A	8/1993	McKenzie	8,590,806 B2 *	11/2013	Drechsel ..... B05B 3/0486 239/222.17
5,372,307 A	12/1994	Sesser	8,991,724 B2	3/2015	Sesser et al.
5,381,960 A	1/1995	Sullivan et al.	9,511,383 B2 *	12/2016	Drechsel ..... B05B 3/008
5,439,174 A	8/1995	Sweet	D882,039 S *	4/2020	Sesser ..... D23/214
5,671,886 A	9/1997	Sesser	D882,040 S *	4/2020	Sesser ..... D23/214
5,699,962 A	12/1997	Scott et al.	D882,041 S *	4/2020	Sesser ..... D23/214
5,950,927 A	9/1999	Elliott et al.	D882,042 S *	4/2020	Sesser ..... D23/214
6,176,440 B1	1/2001	Elliott	D889,601 S *	7/2020	Sesser ..... D23/214
6,186,414 B1	2/2001	Clearman et al.	10,710,103 B2	7/2020	Lawyer et al.
6,199,771 B1	3/2001	Clearman et al.	10,828,653 B2	11/2020	Healy
6,341,711 B1	1/2002	Blake	2006/0108445 A1 *	5/2006	Pinch ..... B05B 3/0486 239/222.21
6,382,525 B1	5/2002	Santiesteban et al.	2006/0249594 A1 *	11/2006	Pinch ..... B05B 3/0486 239/222.21
6,439,477 B1	8/2002	Sweet et al.	2011/0155827 A1	6/2011	Drechsel
6,530,532 B1	3/2003	Santiesteban et al.	2011/0198420 A1 *	8/2011	Lawyer ..... B05B 7/0425 239/589
6,676,038 B2	1/2004	Gressett et al.	2013/0327846 A1	12/2013	Sesser et al.
6,871,795 B2	3/2005	Anuskiewicz	2017/0333924 A1 *	11/2017	Sesser ..... B05B 1/3026
6,899,287 B2 *	5/2005	Pinch ..... B05B 3/005 239/214.13	2018/0311684 A1	11/2018	Lawyer et al.
6,932,279 B2	8/2005	Burcham	2019/0054481 A1 *	2/2019	Sesser ..... B05B 3/0486
7,037,960 B2	5/2006	Ukai	2020/0047195 A1	2/2020	Healy
7,070,122 B2	7/2006	Burcham et al.	2020/0290060 A1	9/2020	Lawyer et al.
7,287,710 B1	10/2007	Nelson et al.			
D567,329 S *	4/2008	Holmes ..... D23/214			

\* cited by examiner



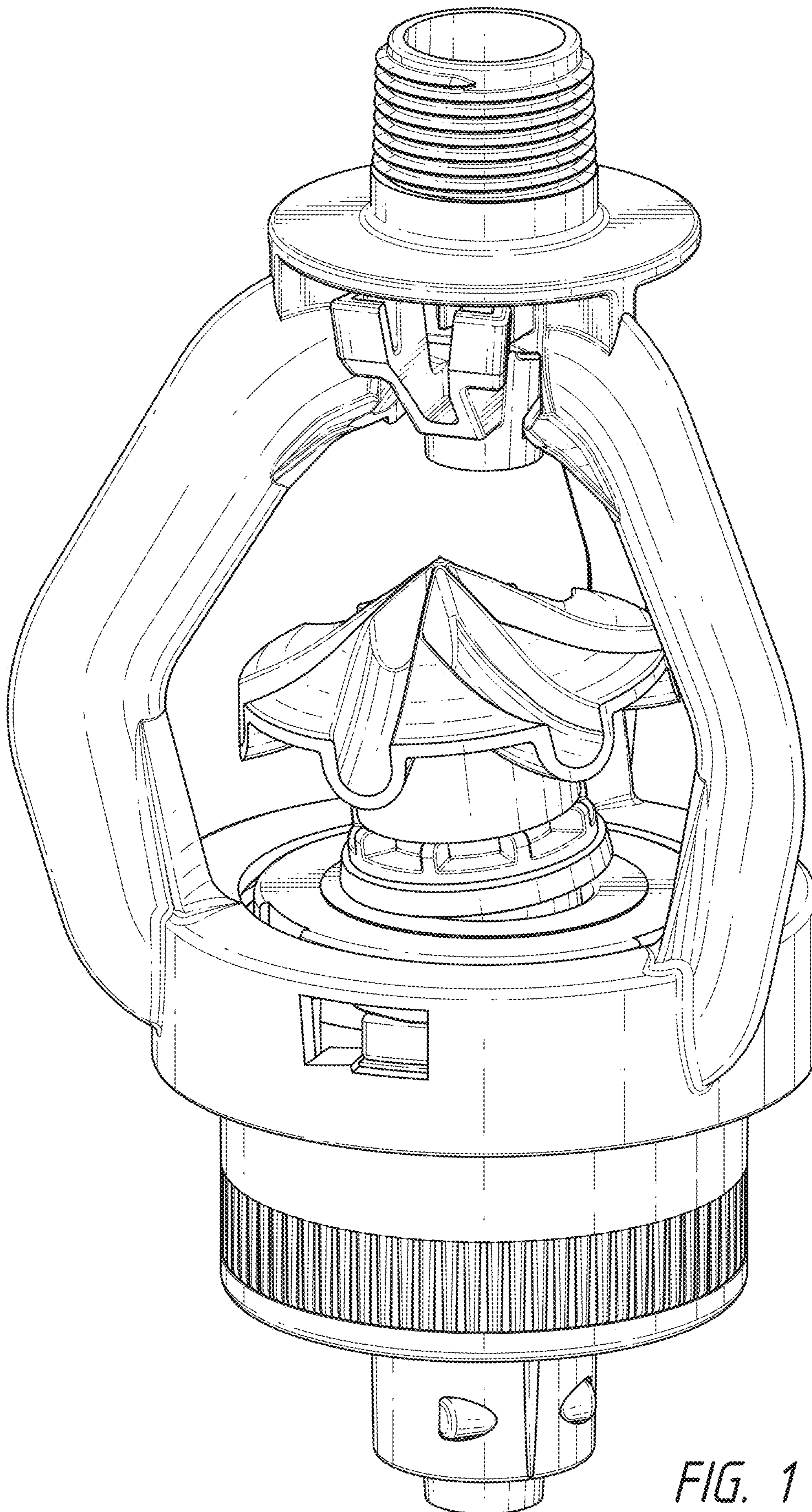

FIG. 1

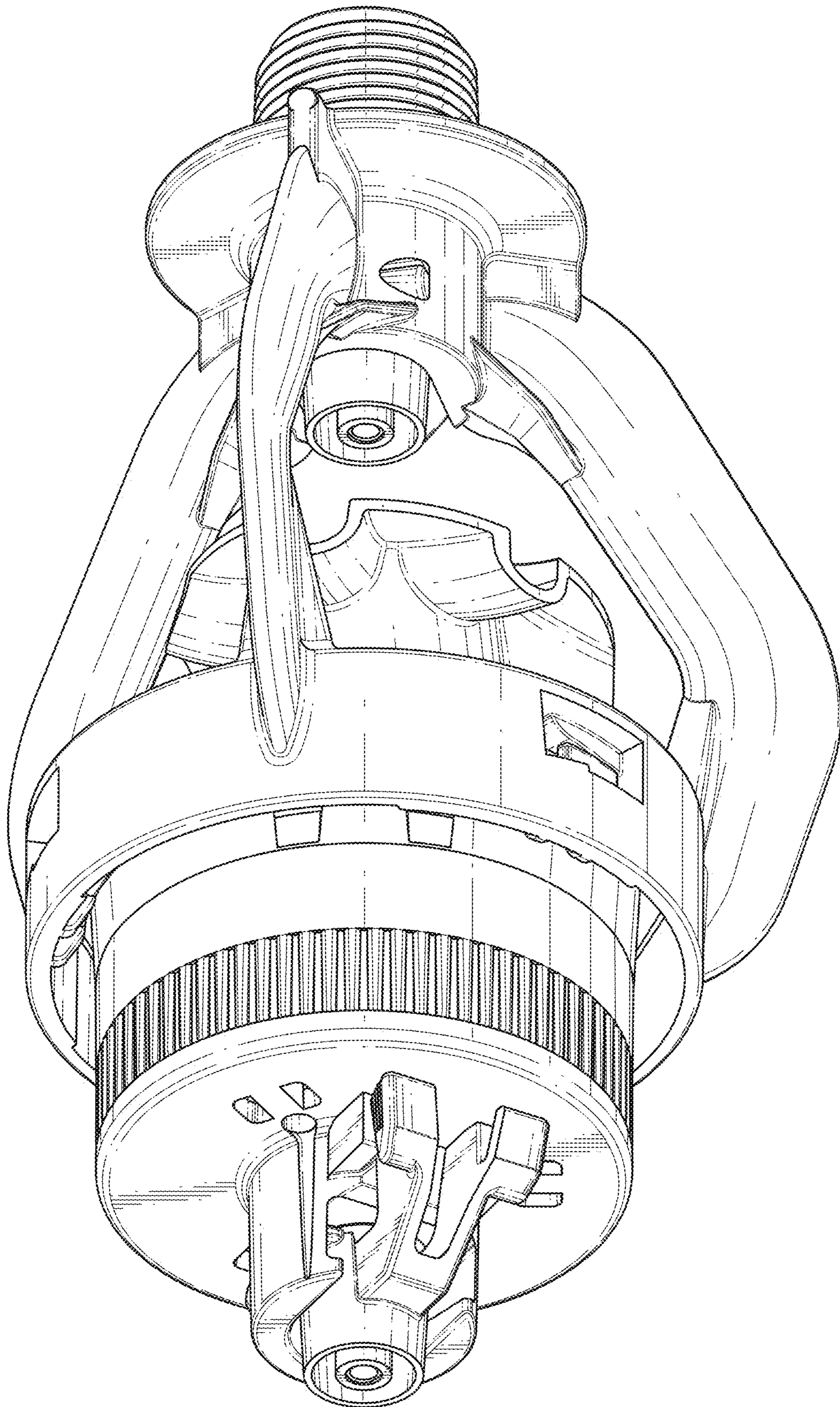

FIG. 2



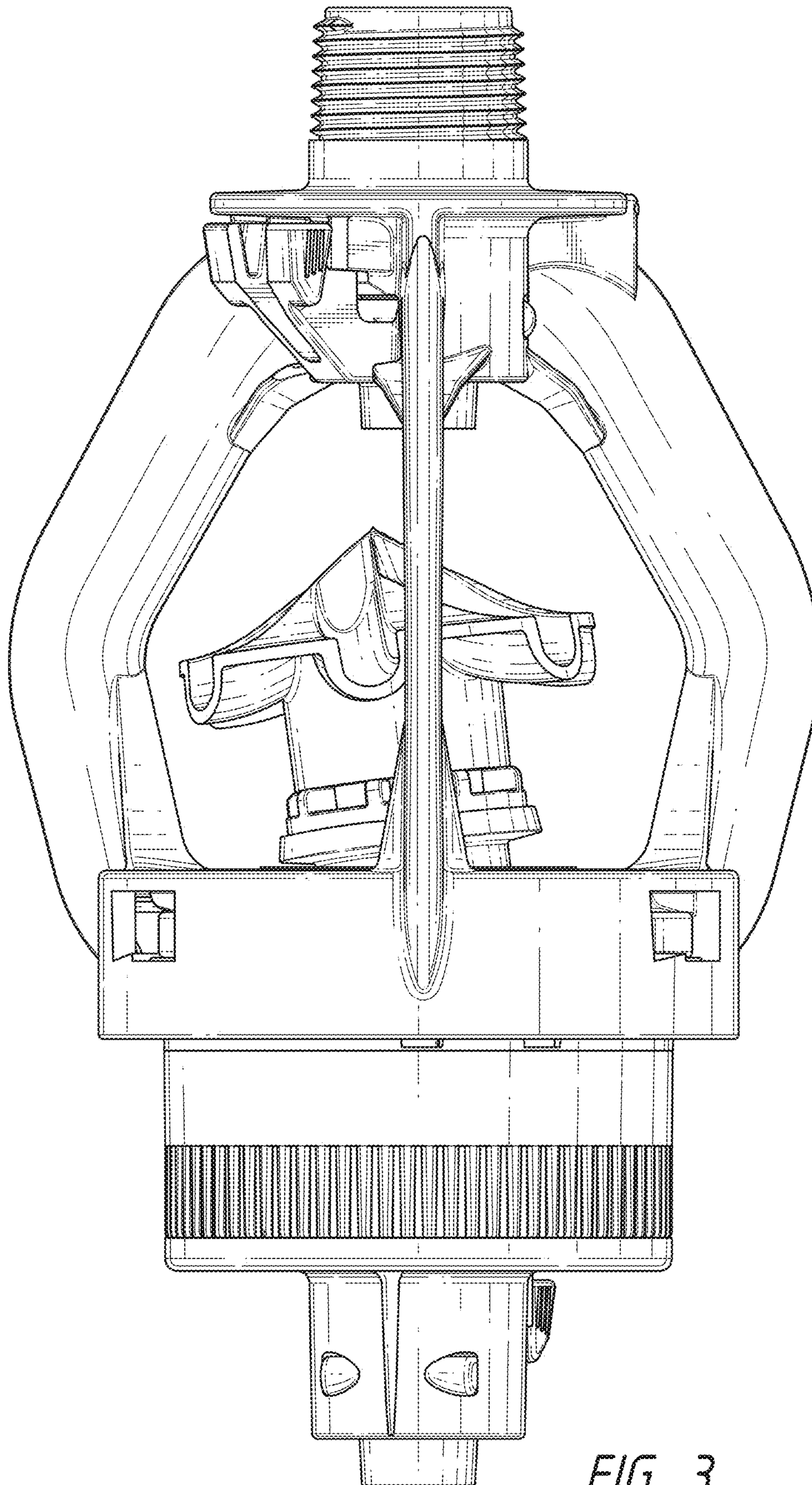

FIG. 3

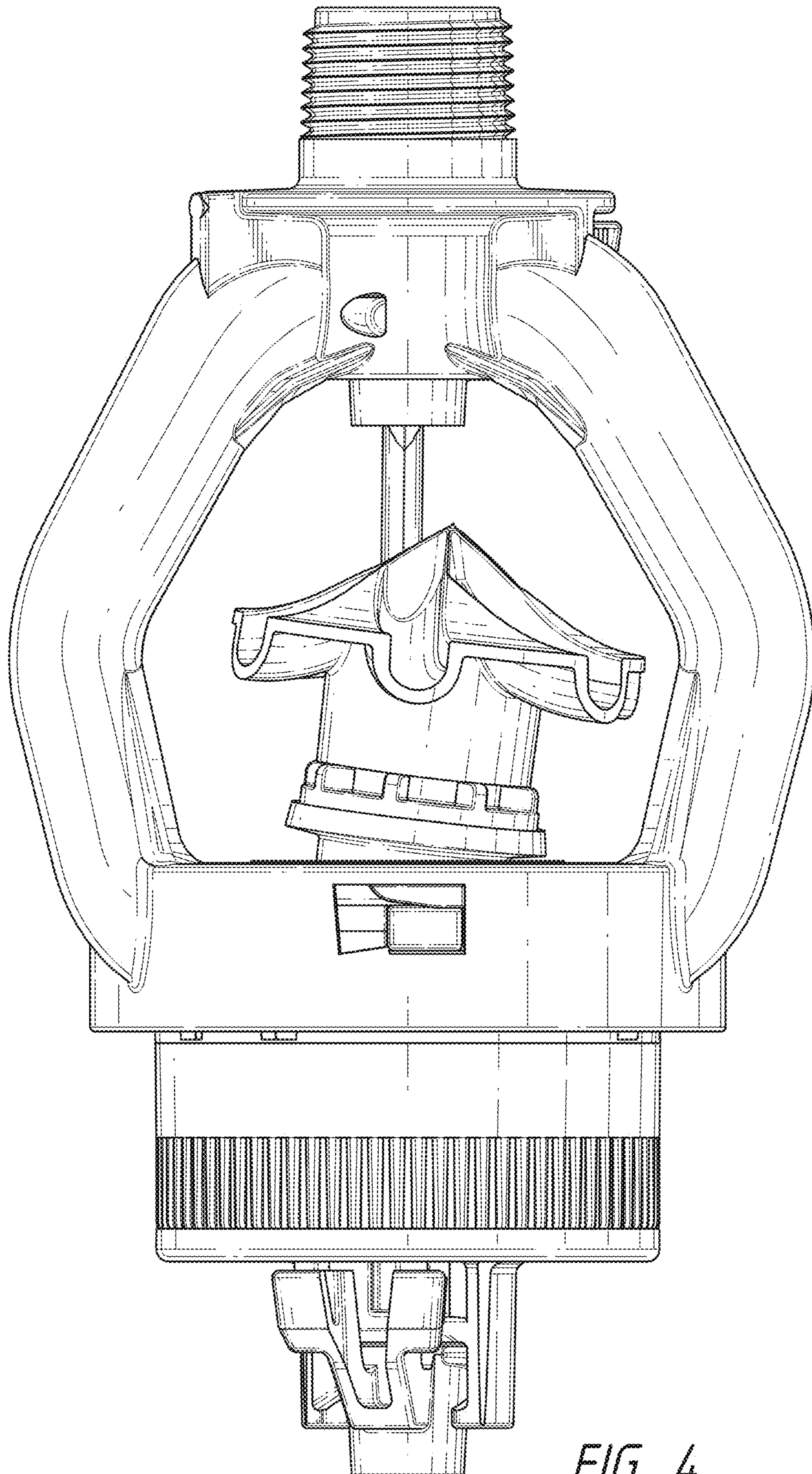

FIG. 4



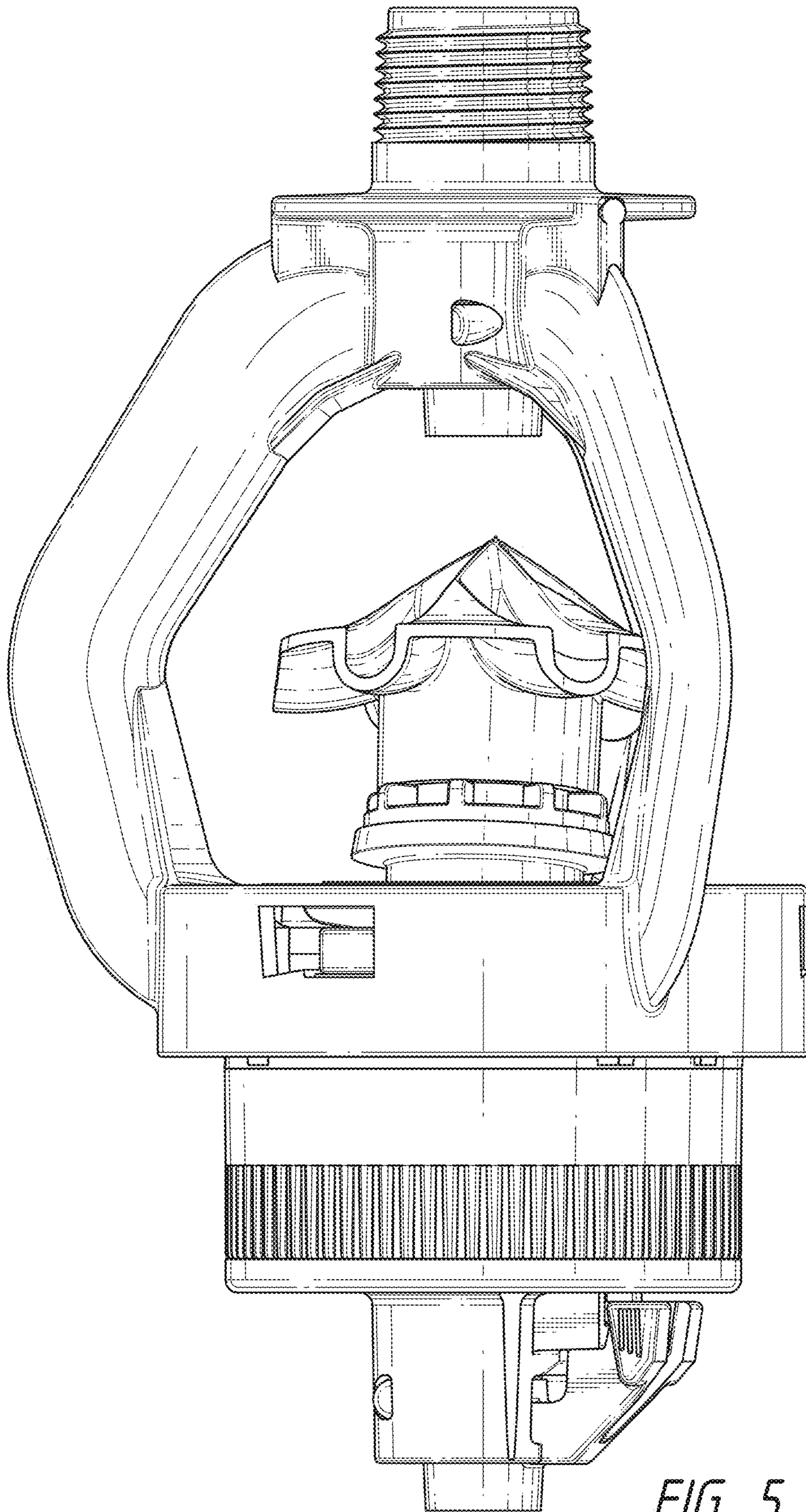

FIG. 5

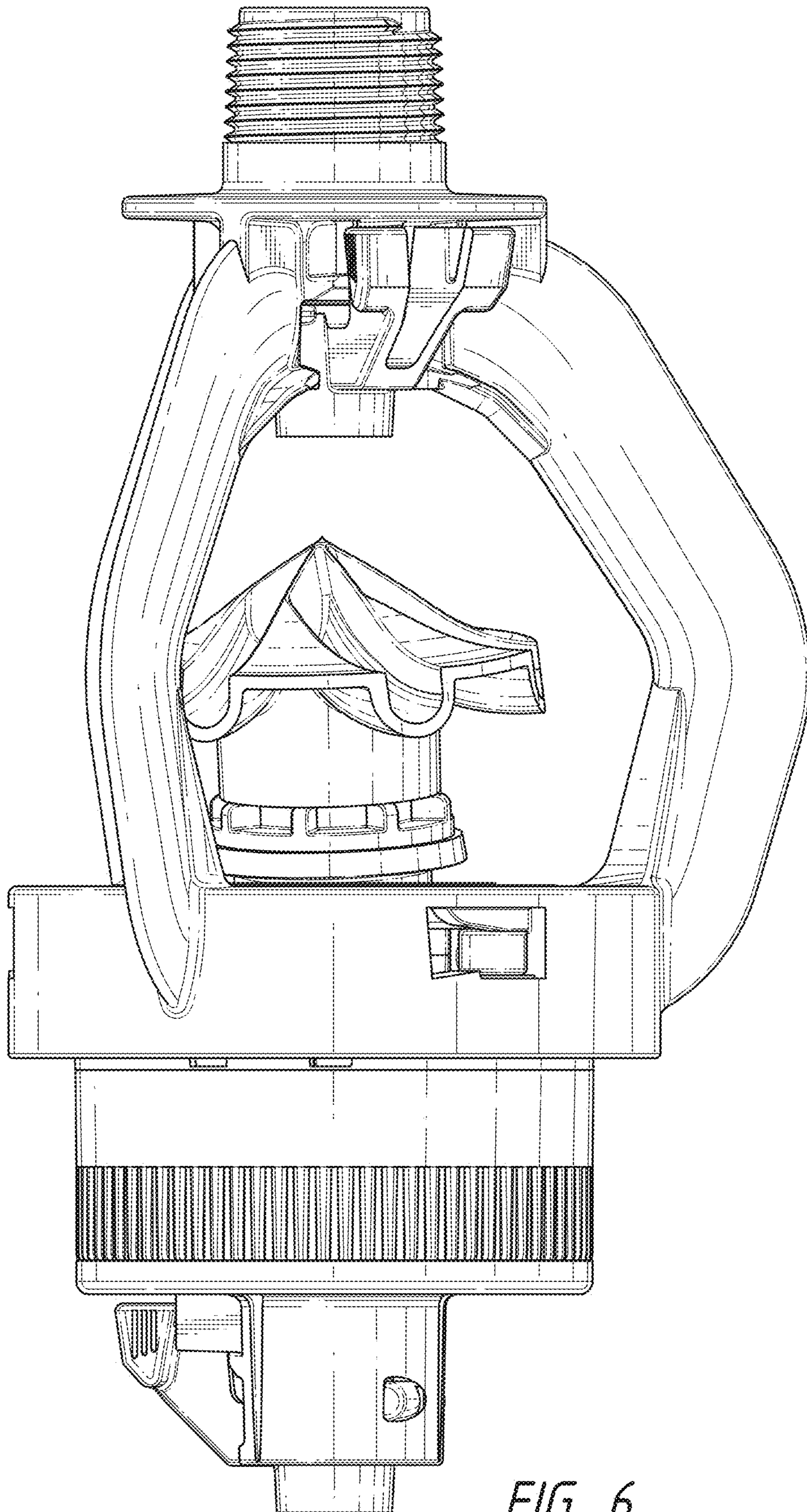

FIG. 6



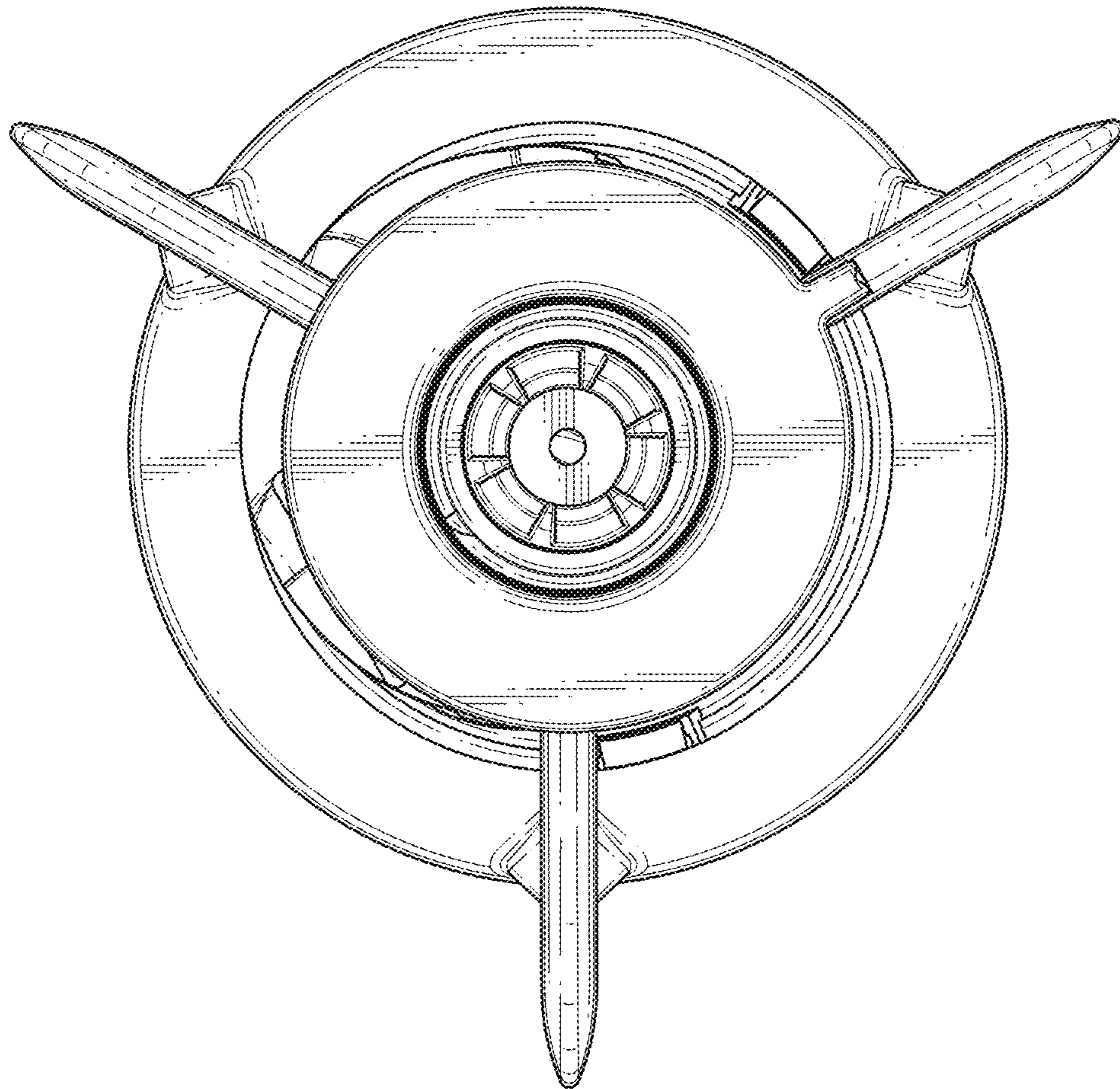

FIG. 7

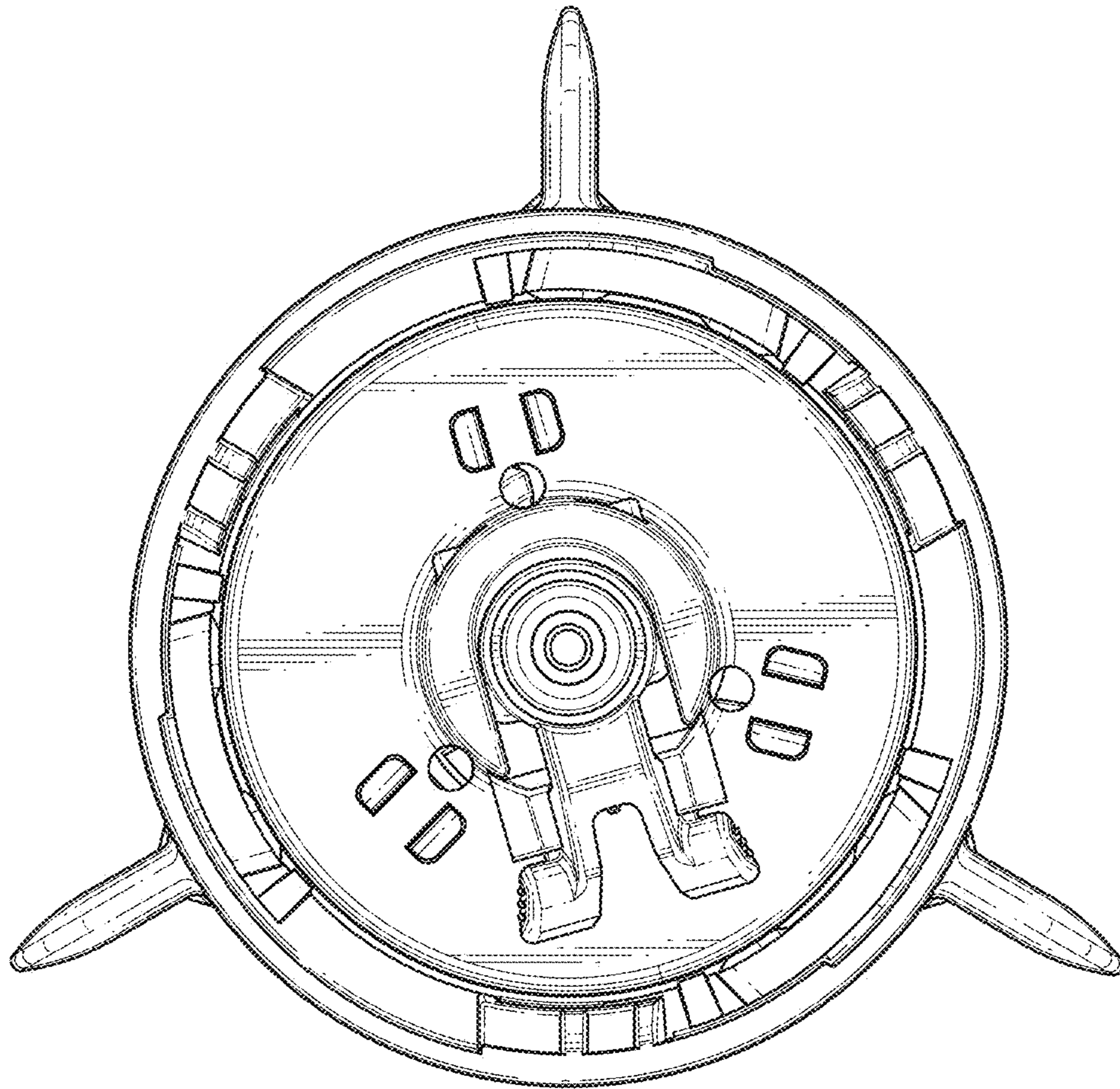

FIG. 8



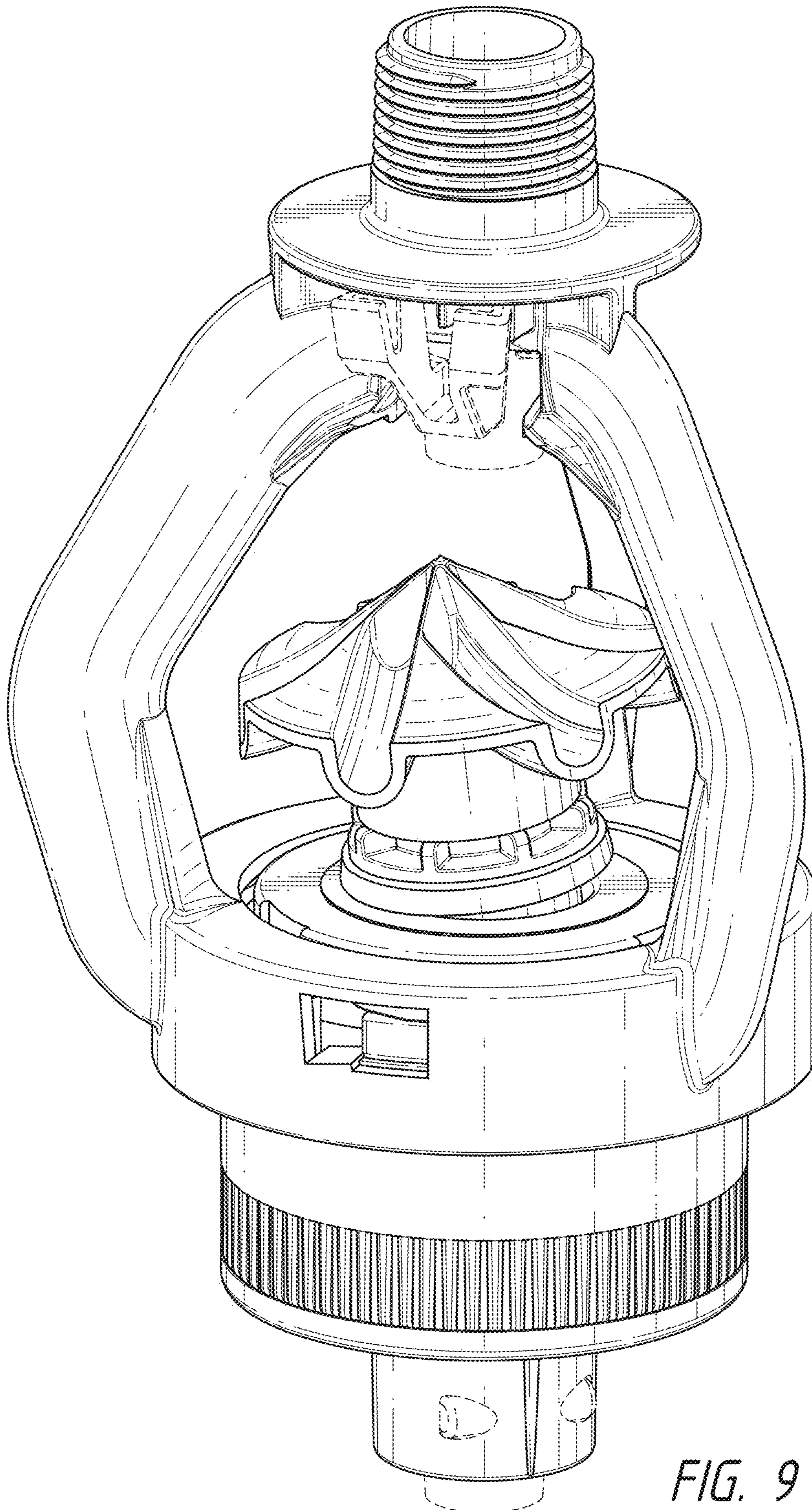

FIG. 9

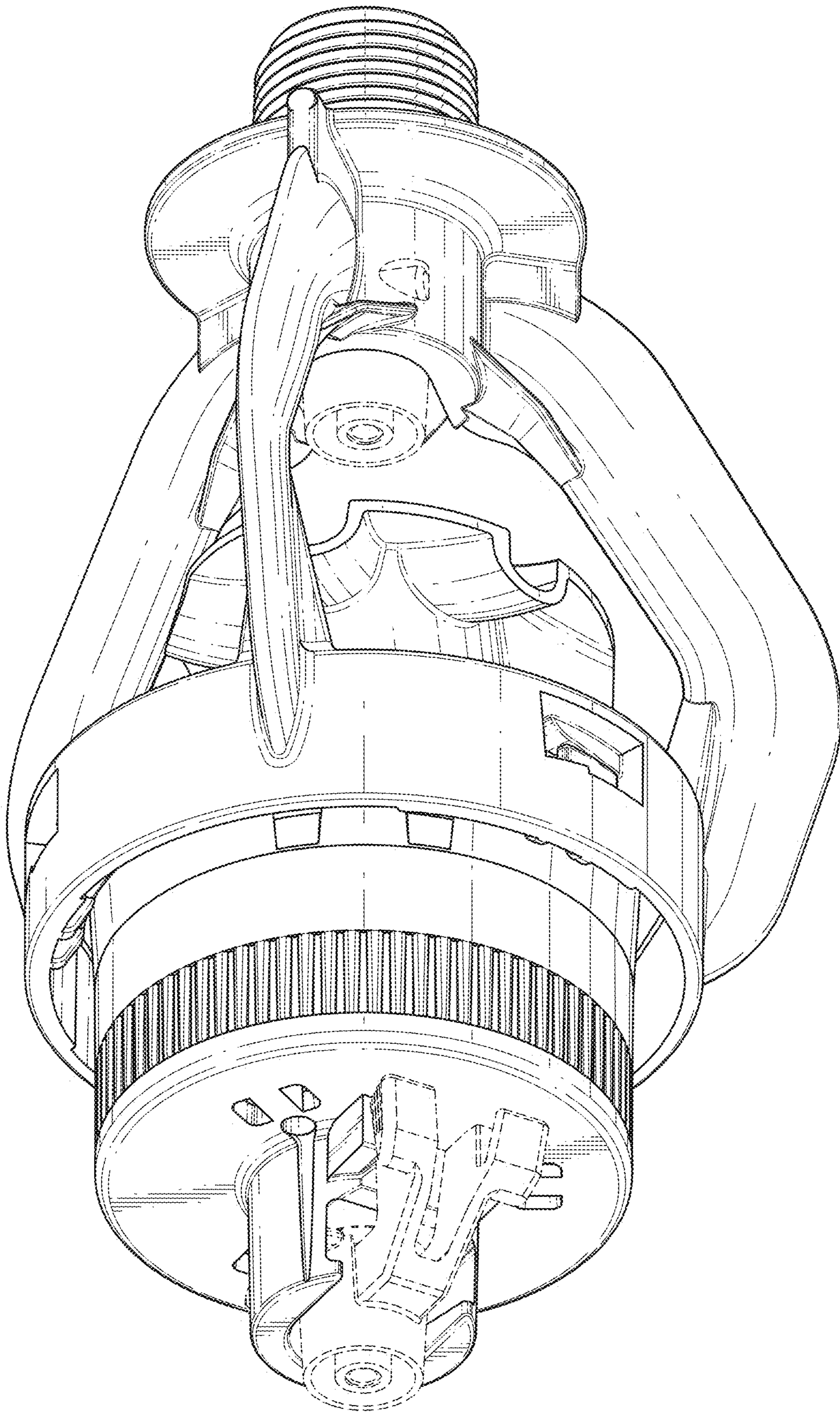

FIG. 10



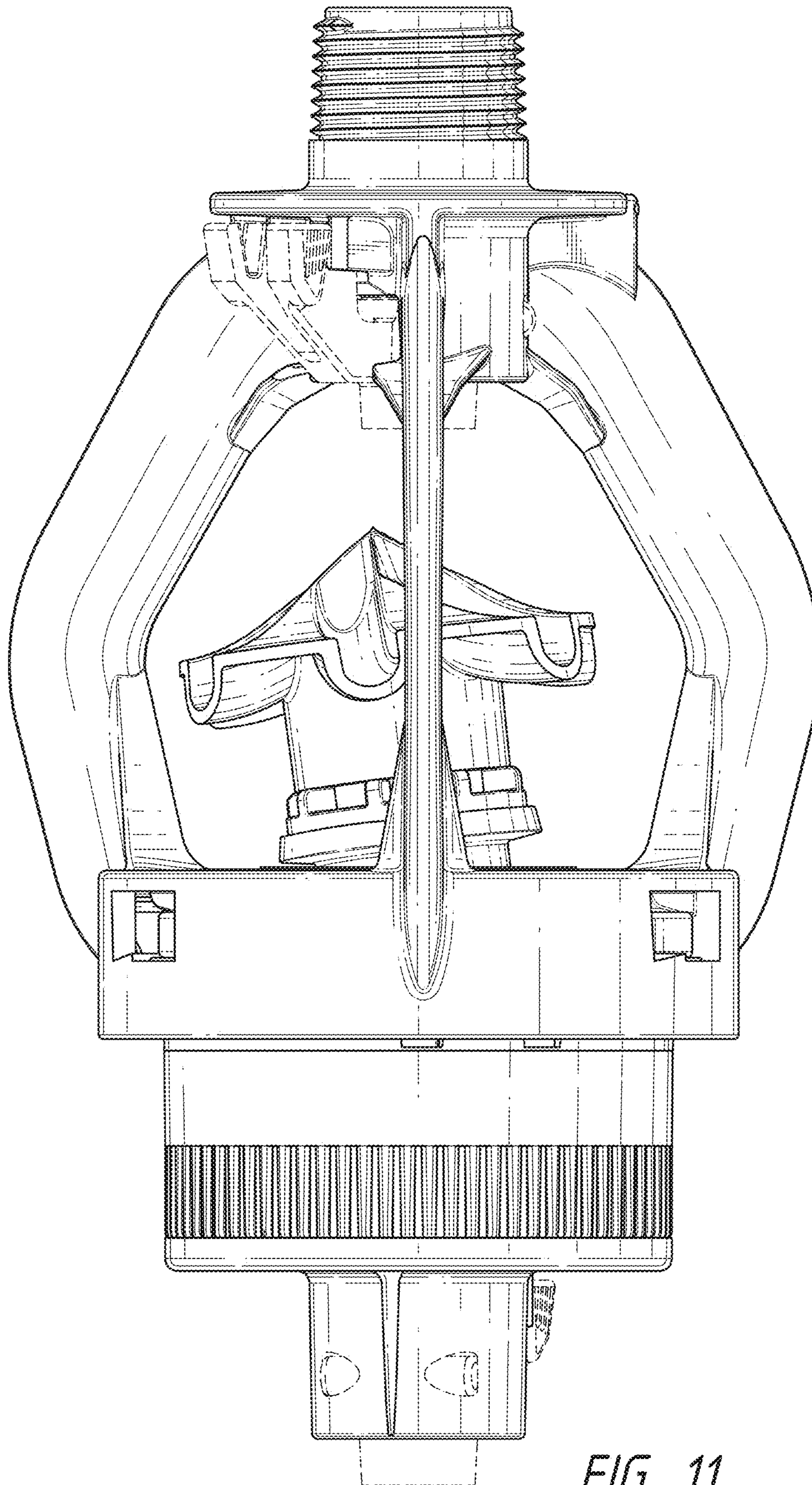

FIG. 11

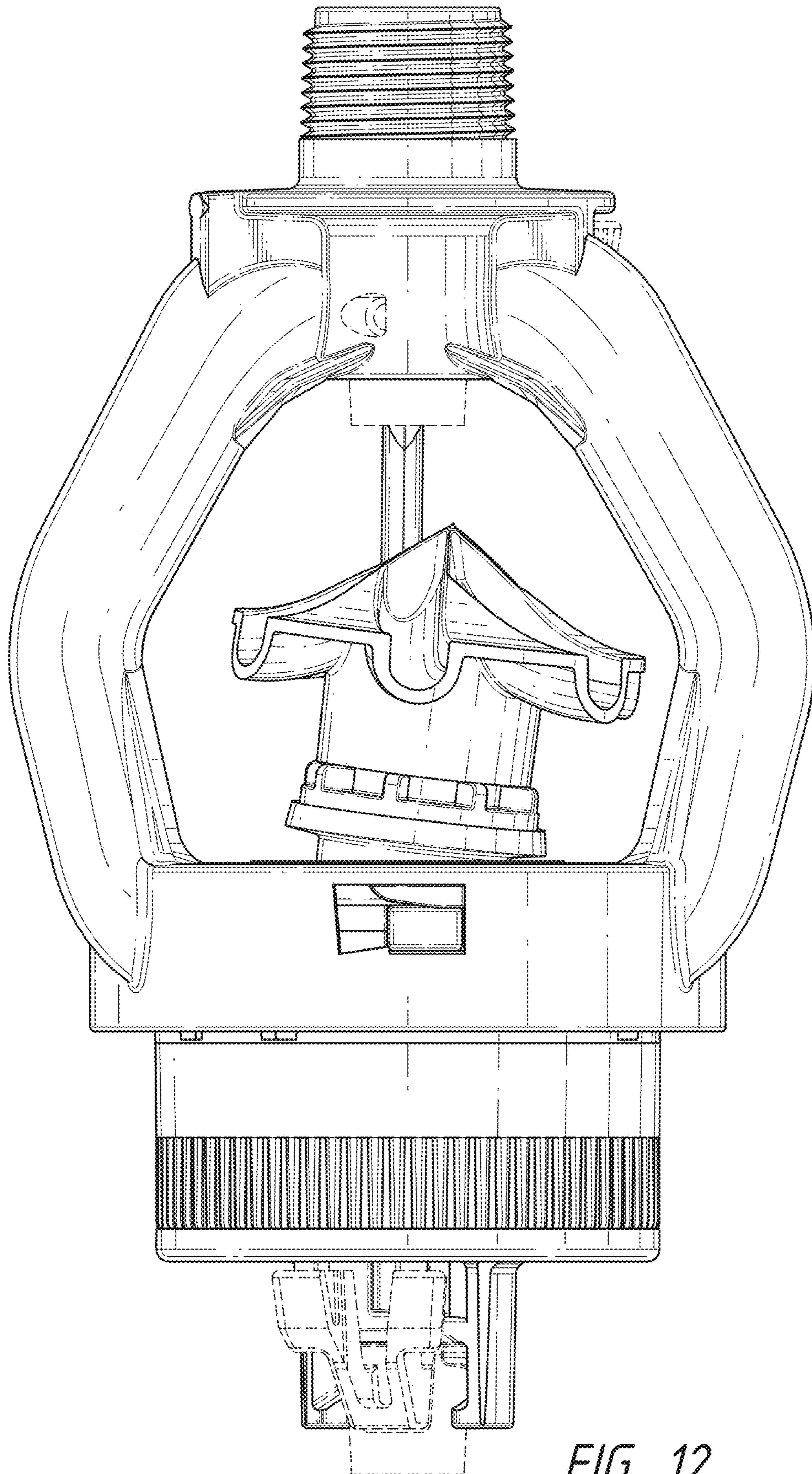

FIG. 12



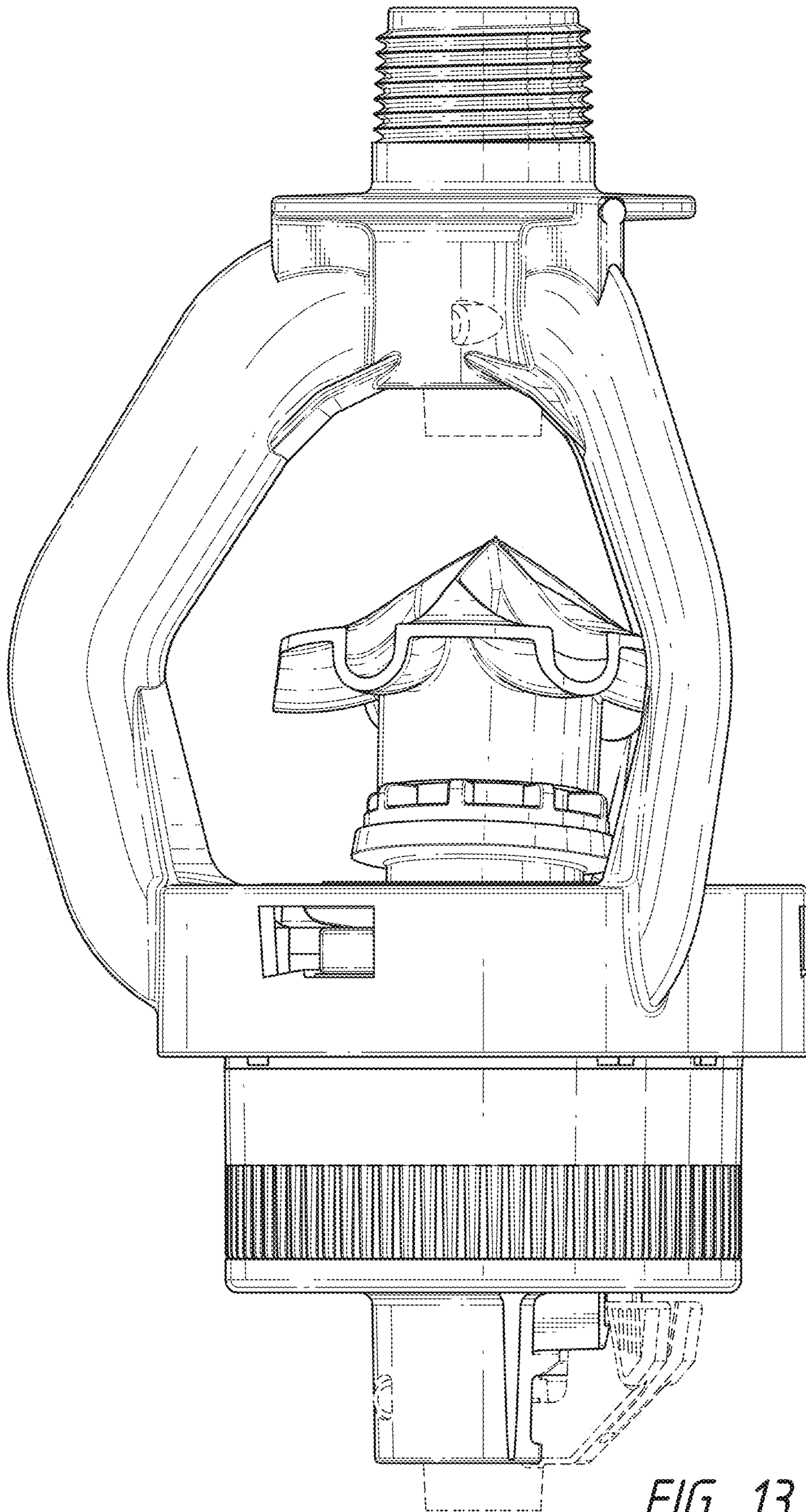

FIG. 13

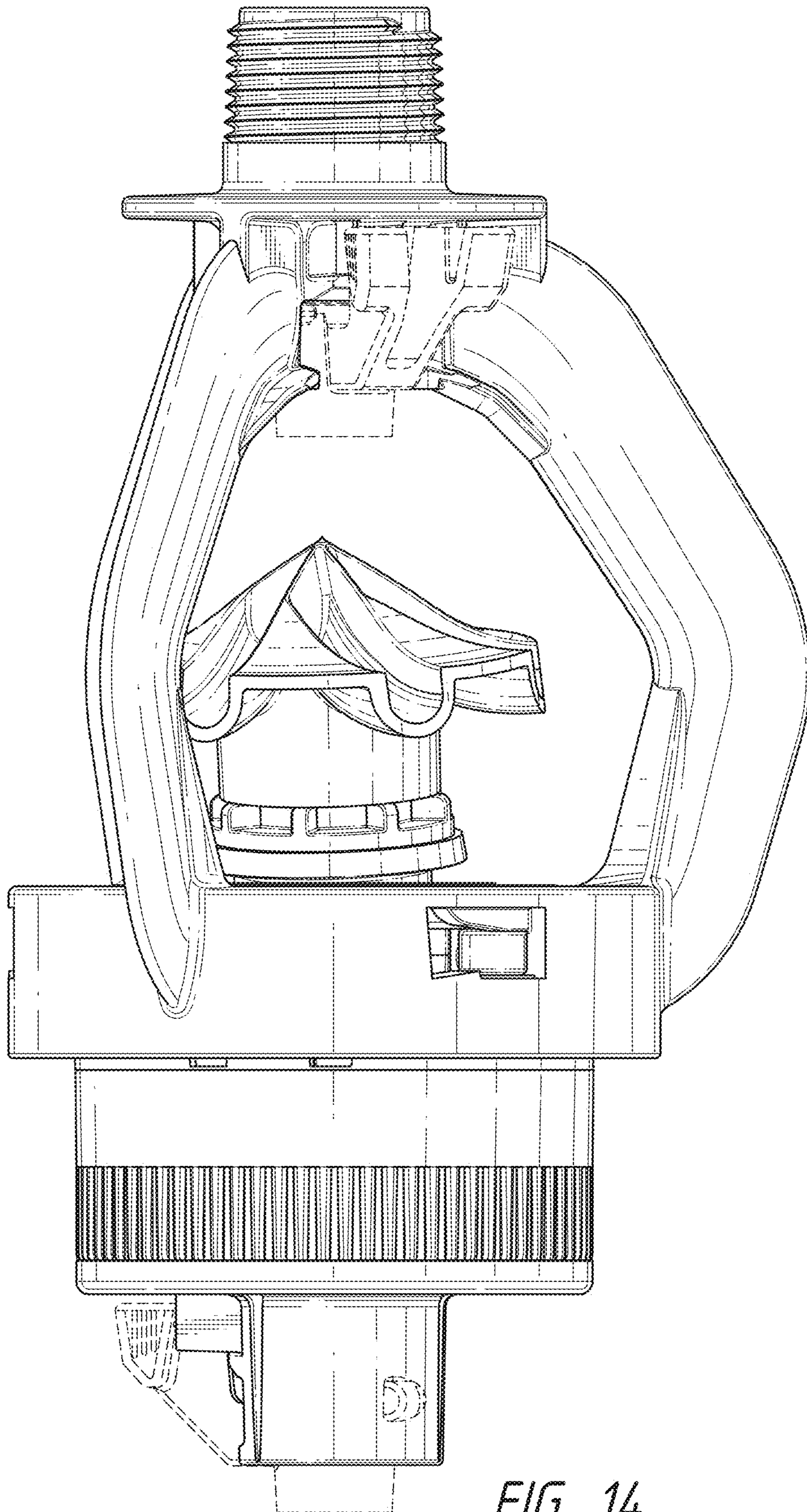
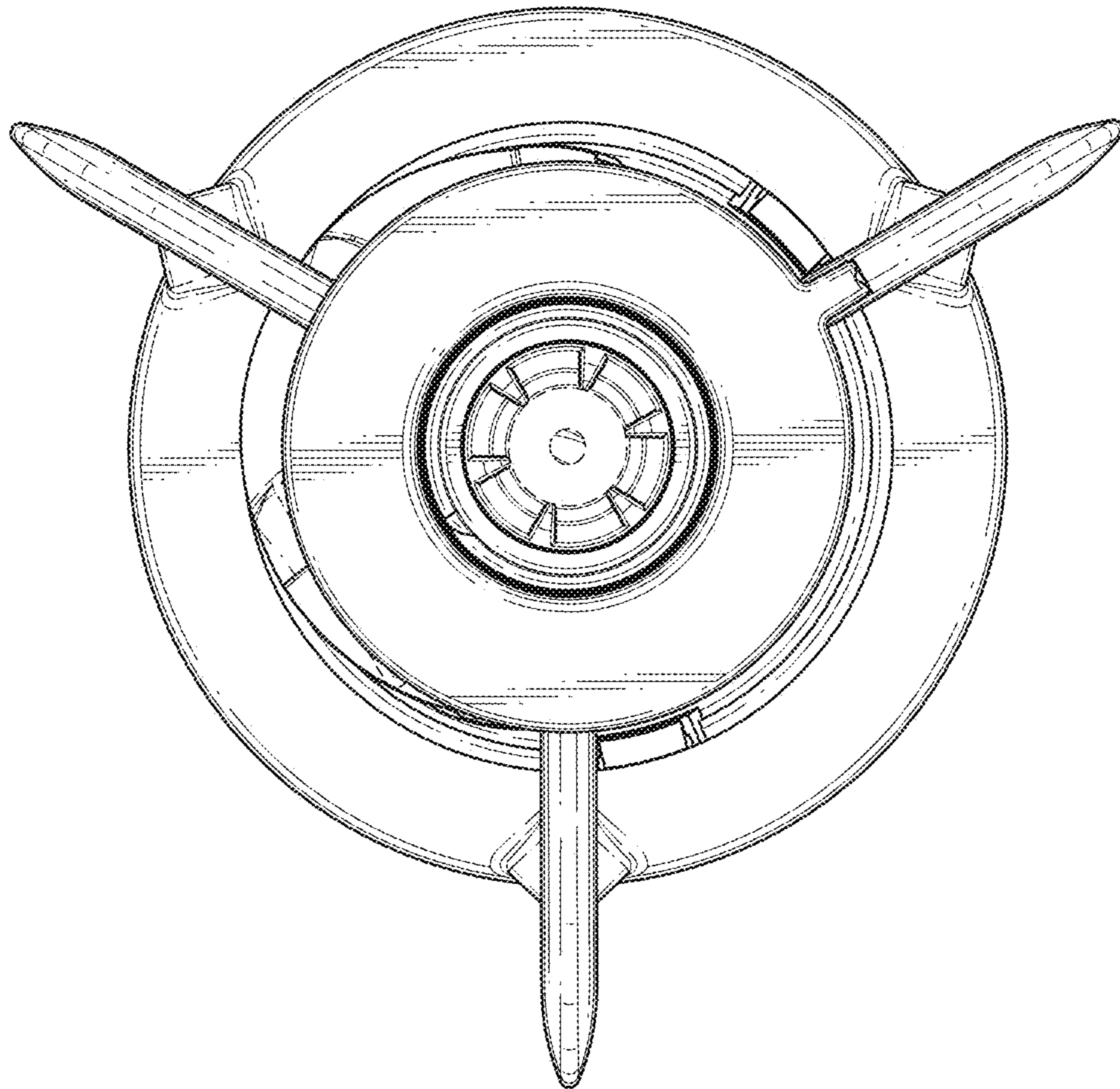

FIG. 14





*FIG. 15*

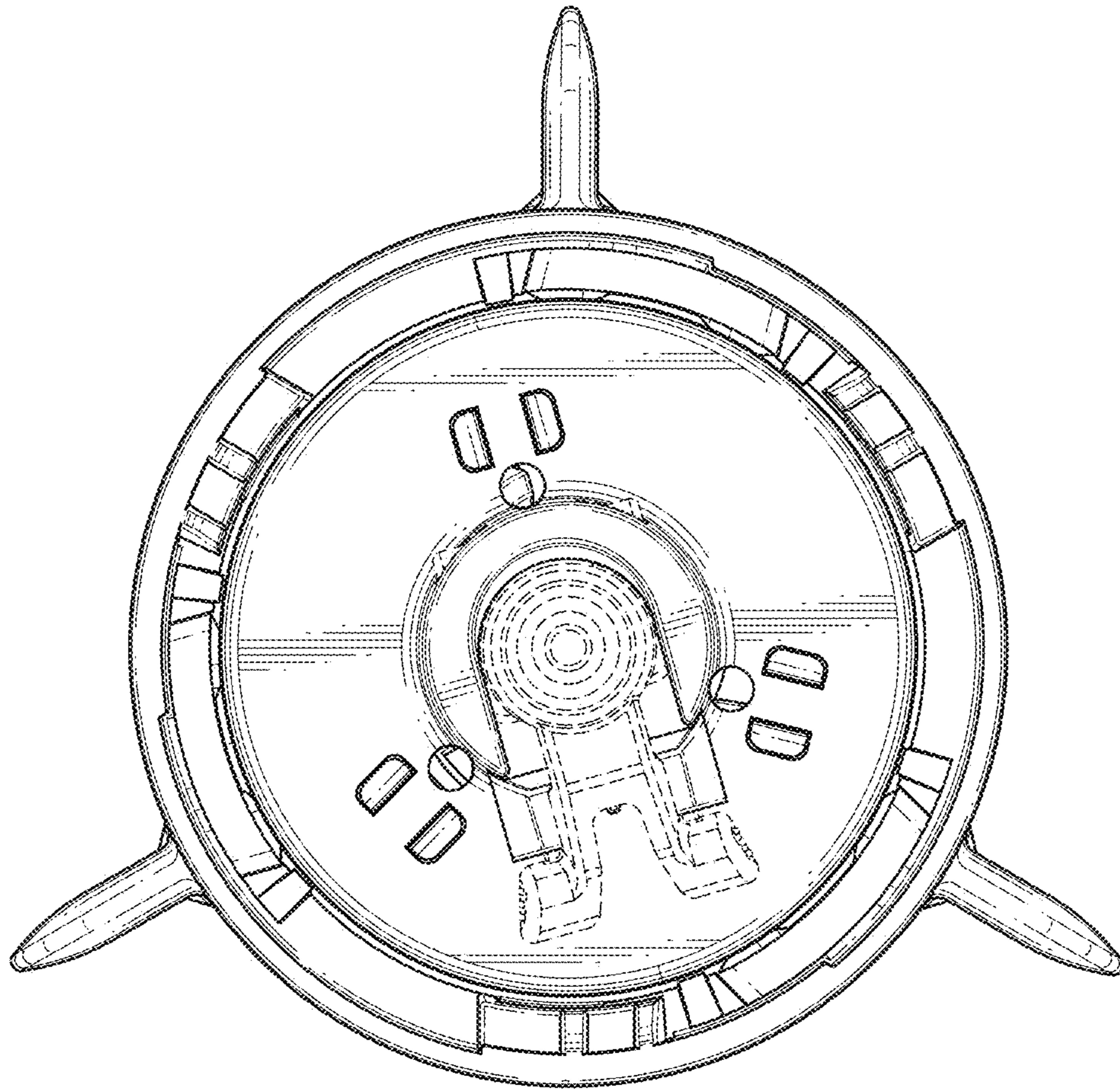

FIG. 16