



US00D929506S

(12) **United States Design Patent**  
**Wang**

(10) **Patent No.:** **US D929,506 S**

(45) **Date of Patent:** **\*\* \*Aug. 31, 2021**

(54) **TOY CAR**

(71) Applicant: **Zhongzi Wang**, Shantou (CN)

(72) Inventor: **Zhongzi Wang**, Shantou (CN)

(\*) Notice: This patent is subject to a terminal disclaimer.

(\*\*) Term: **15 Years**

(21) Appl. No.: **29/702,631**

(22) Filed: **Aug. 21, 2019**

(51) **LOC (13) Cl.** ..... **21-01**

(52) **U.S. Cl.**  
USPC ..... **D21/549**

(58) **Field of Classification Search**  
USPC ..... D21/398, 533, 548, 549, 550, 560,  
D21/578-581; D12/88, 92, 108  
CPC .... A63H 17/26; A63H 17/262; A63H 17/264;  
A63H 17/266; A63H 17/36; A63H 17/38;  
A63H 29/00; A63H 29/22; A63H 29/24;  
A63H 30/04

See application file for complete search history.

(56) **References Cited**

**U.S. PATENT DOCUMENTS**

D218,340 S \* 8/1970 McLaren ..... D21/548  
D506,161 S 6/2005 Frank  
D513,630 S 1/2006 Ming  
D552,513 S \* 10/2007 Castriota ..... D12/88

D679,762 S \* 4/2013 Lee ..... D21/550  
D685,862 S \* 7/2013 Martino ..... D21/533  
D769,378 S 10/2016 Belker et al.  
D770,574 S 11/2016 Belker et al.  
D792,526 S \* 7/2017 Belker ..... D21/561  
D813,725 S \* 3/2018 Filippini ..... D12/86  
D822,769 S \* 7/2018 Tatopoulos ..... D21/533  
D832,938 S \* 11/2018 Langberg ..... D21/548  
D836,730 S \* 12/2018 Hego ..... D21/550  
2012/0052767 A1 \* 3/2012 Martino ..... A63H 17/00  
446/465

\* cited by examiner

*Primary Examiner* — Cynthia M. Chin

(74) *Attorney, Agent, or Firm* — Rumit Ranjit Kanakia

(57) **CLAIM**

I claim the ornamental design for a toy car, as shown and described.

**DESCRIPTION**

FIG. 1 is a Perspective view of a toy car showing my new design;  
FIG. 2 is a Front view of the toy car as shown in FIG. 1;  
FIG. 3 is a Back view of the toy car as shown in FIG. 1;  
FIG. 4 is a Left-side view of the toy car as shown in FIG. 1;  
FIG. 5 is a Right-side view of the toy car as shown in FIG. 1;  
FIG. 6 is a Top view of the toy car as shown in FIG. 1; and,  
FIG. 7 is a Bottom view of the toy car as shown in FIG. 1.  
The broken lines are for the purpose of illustrating portions of the article that form no part of the claim.

**1 Claim, 6 Drawing Sheets**

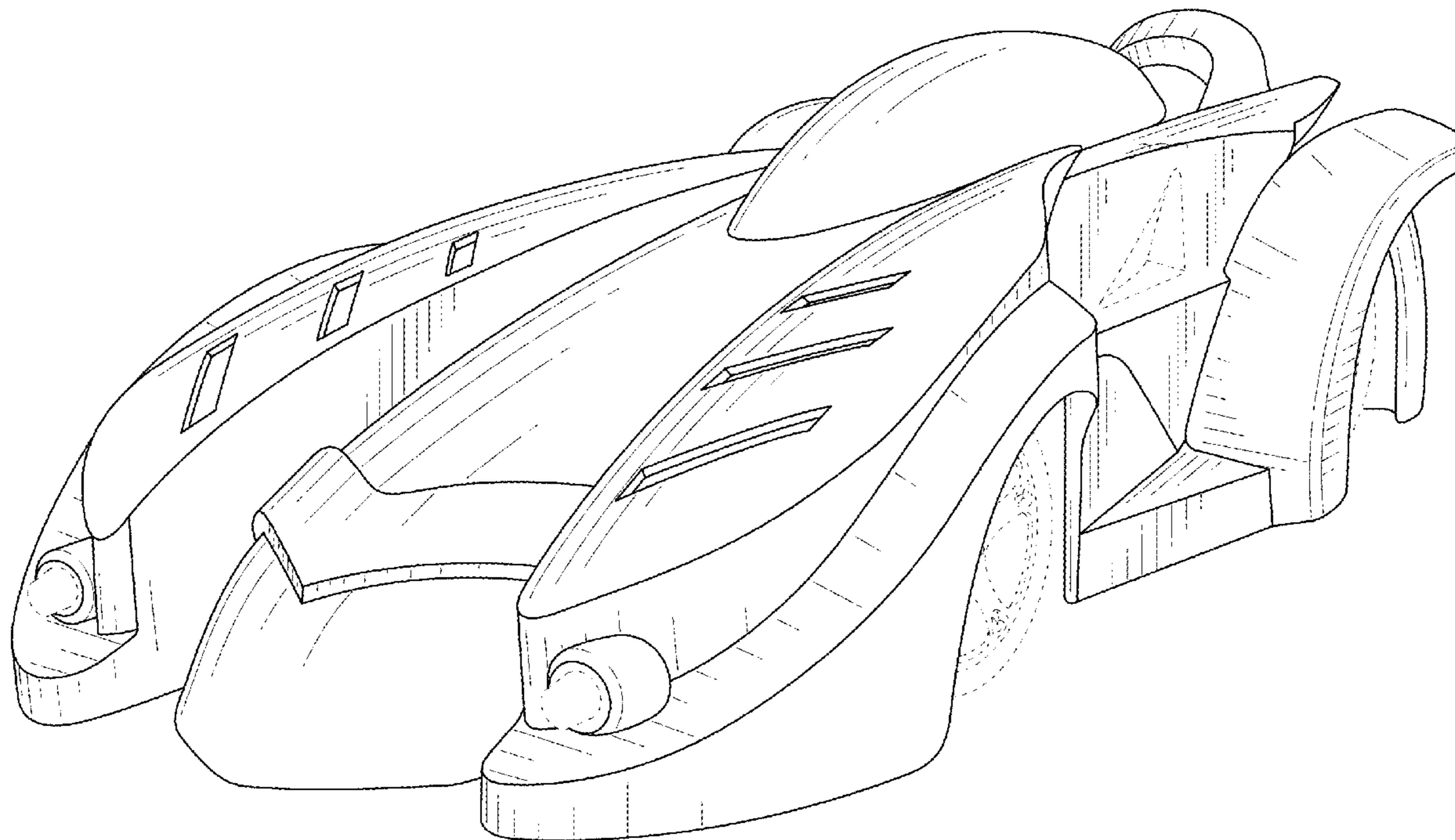

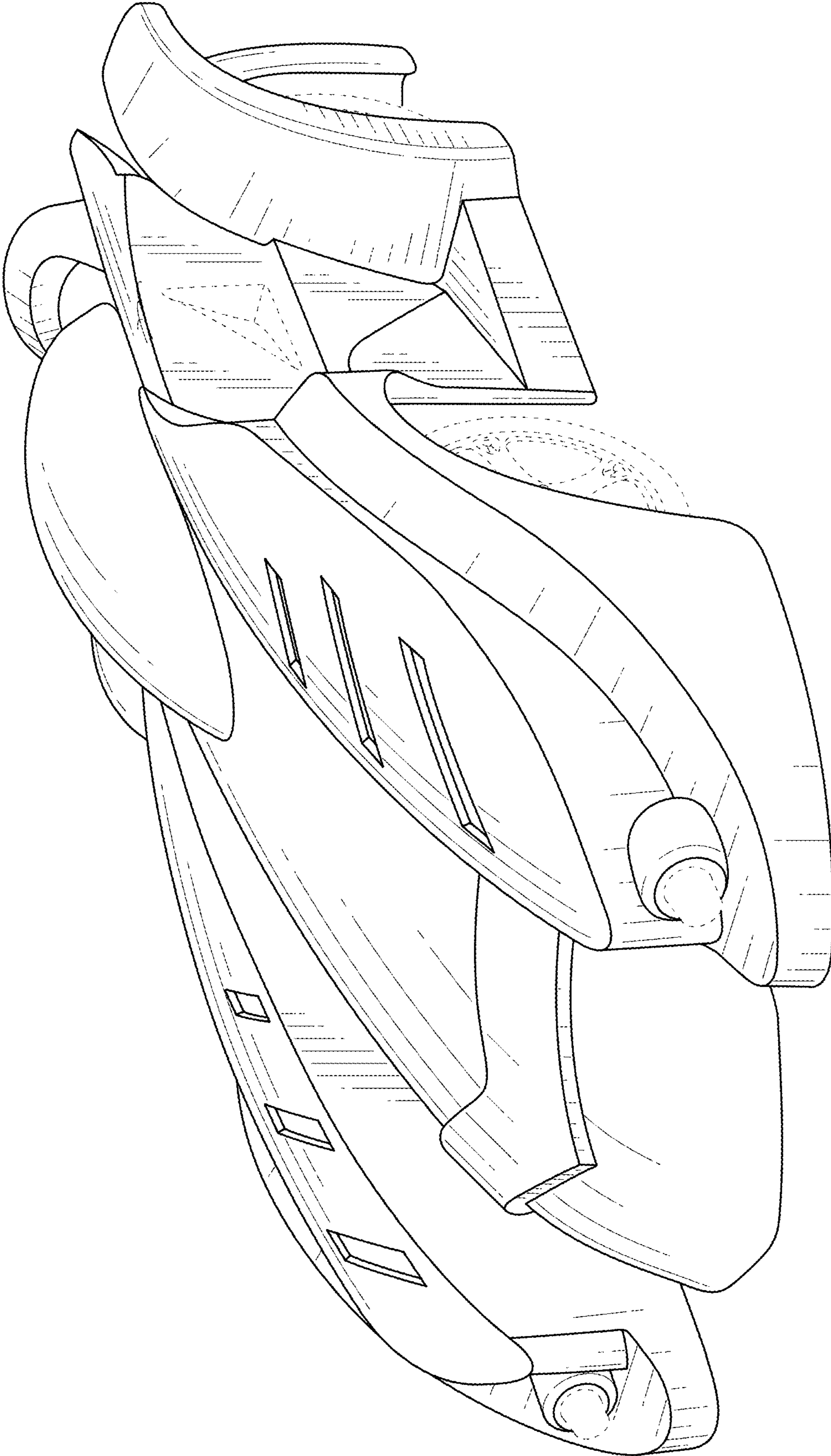

FIG. 1

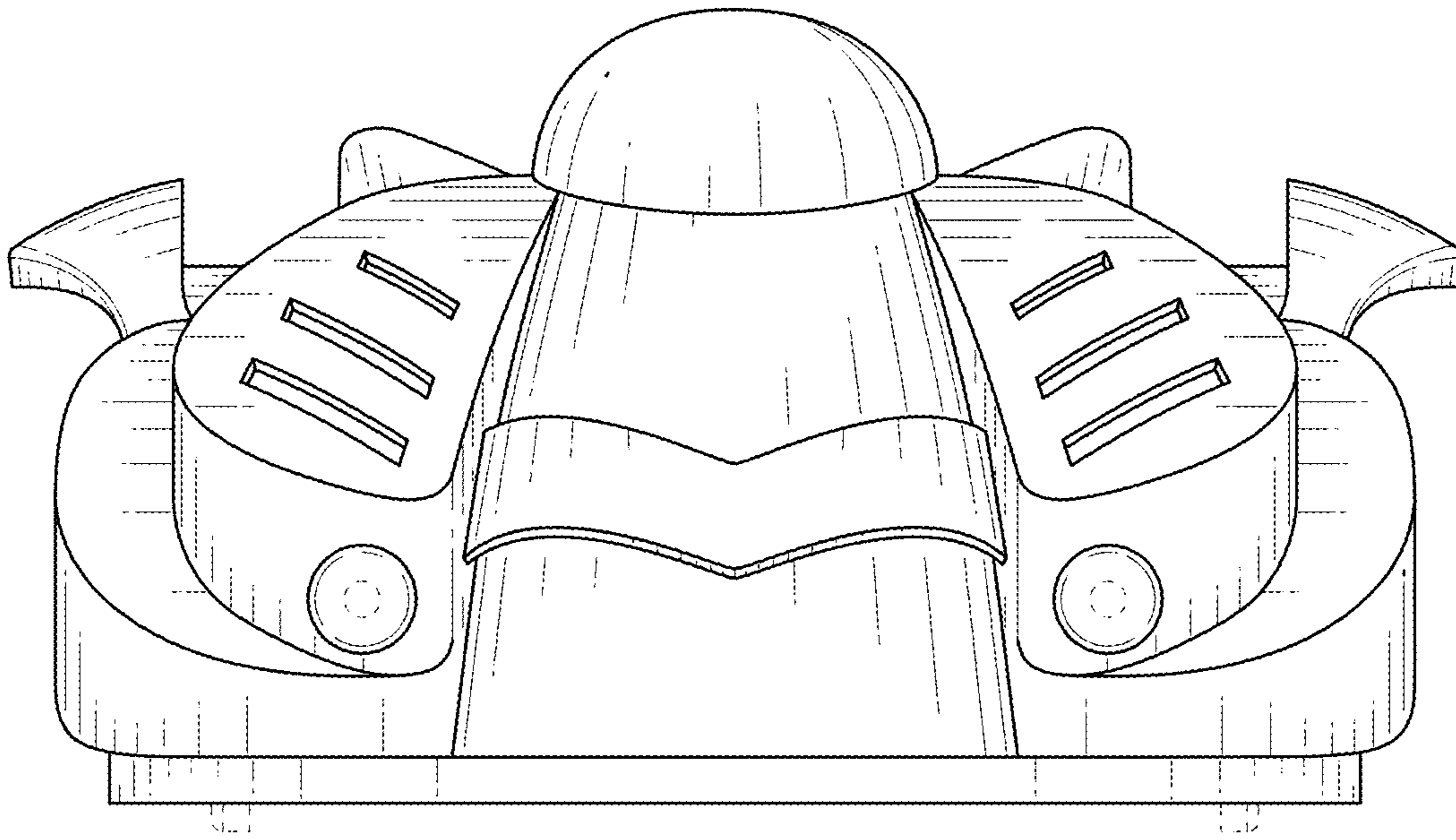

FIG. 2

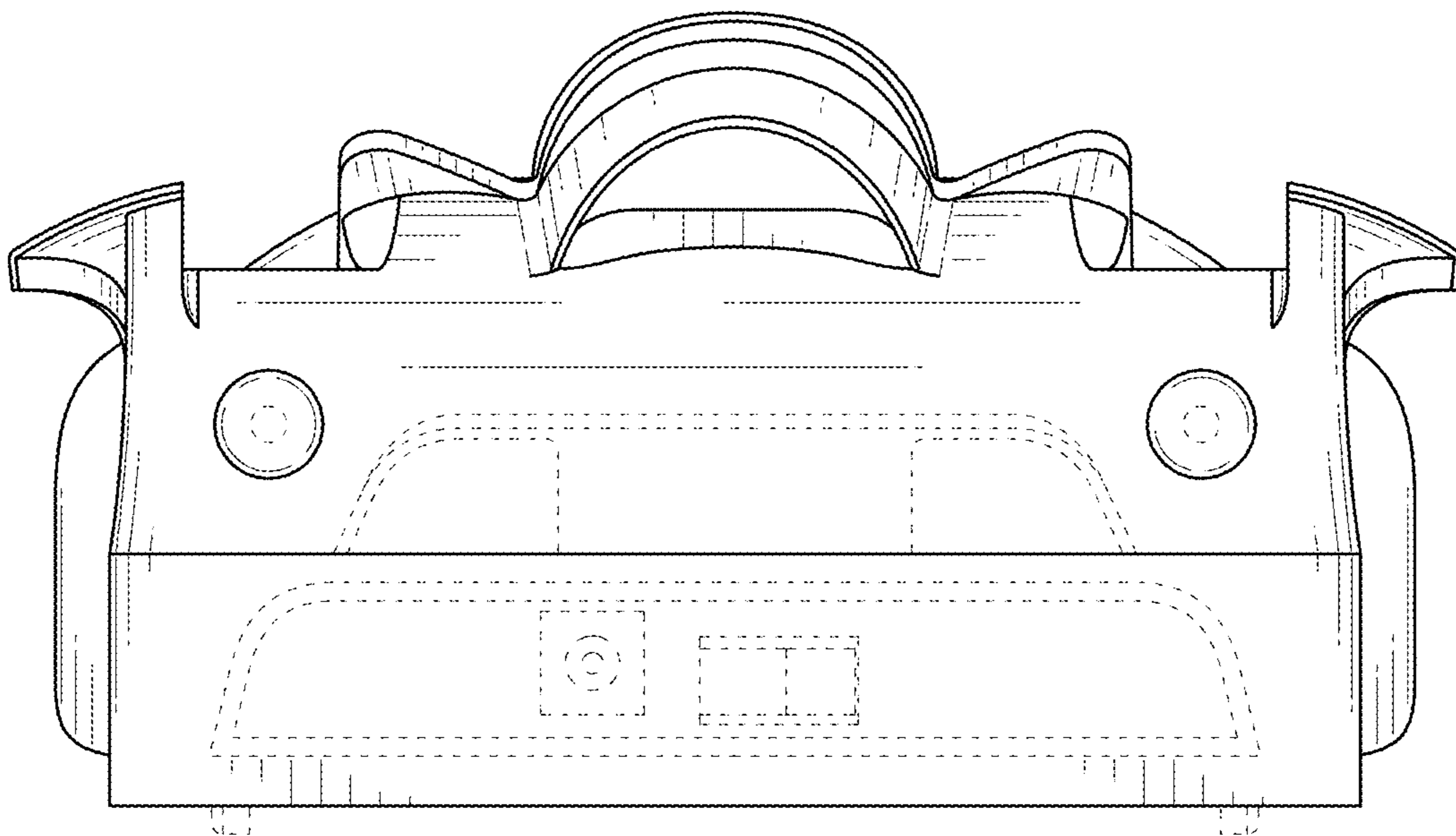

FIG. 3

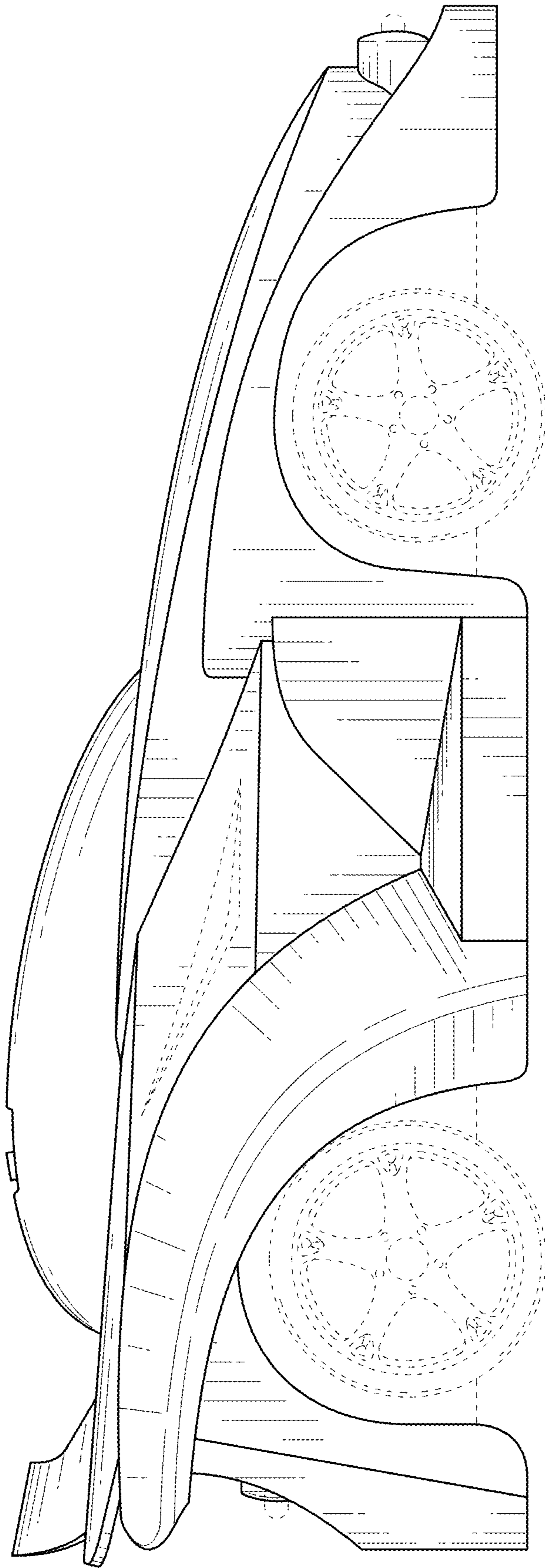

FIG. 4

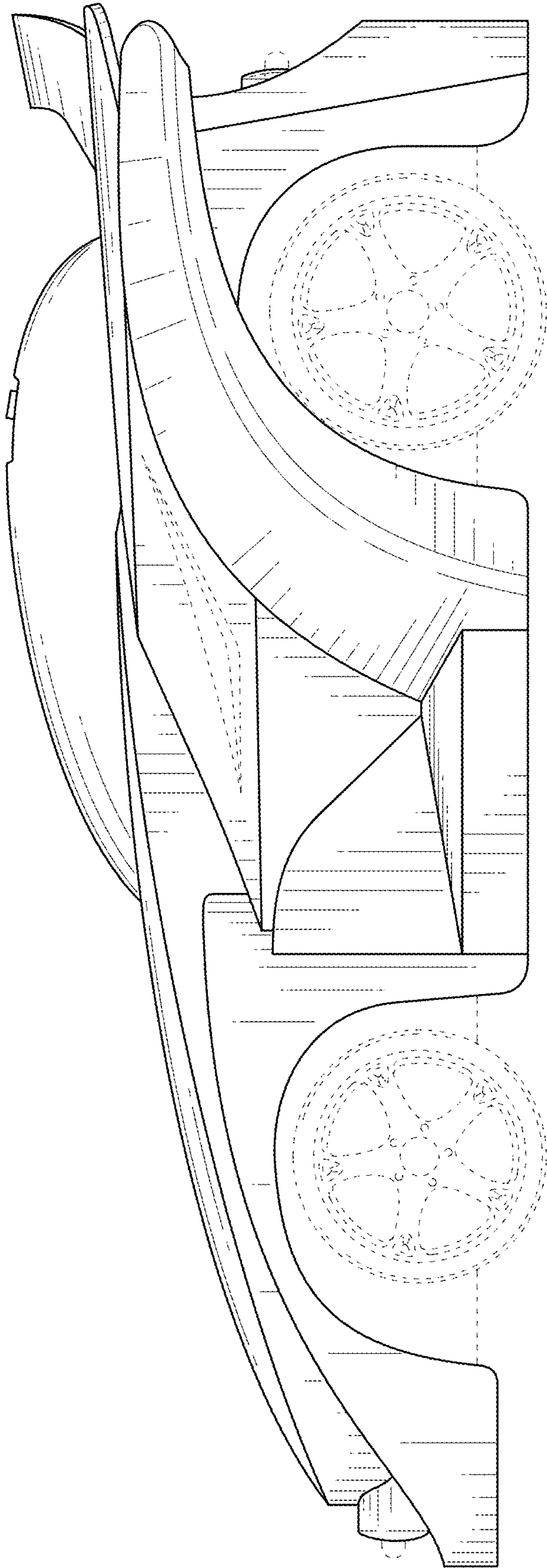

FIG. 5

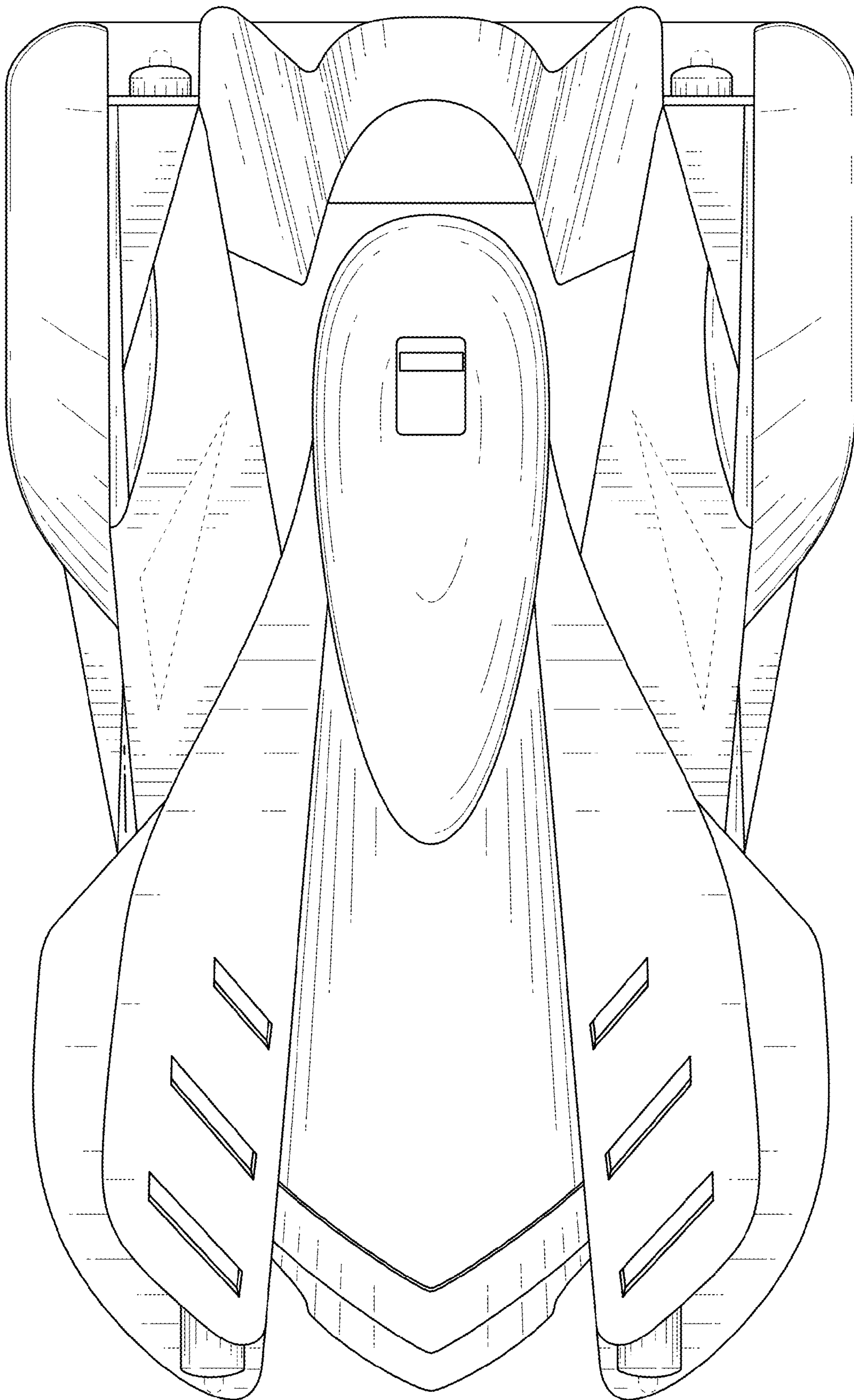

FIG. 6

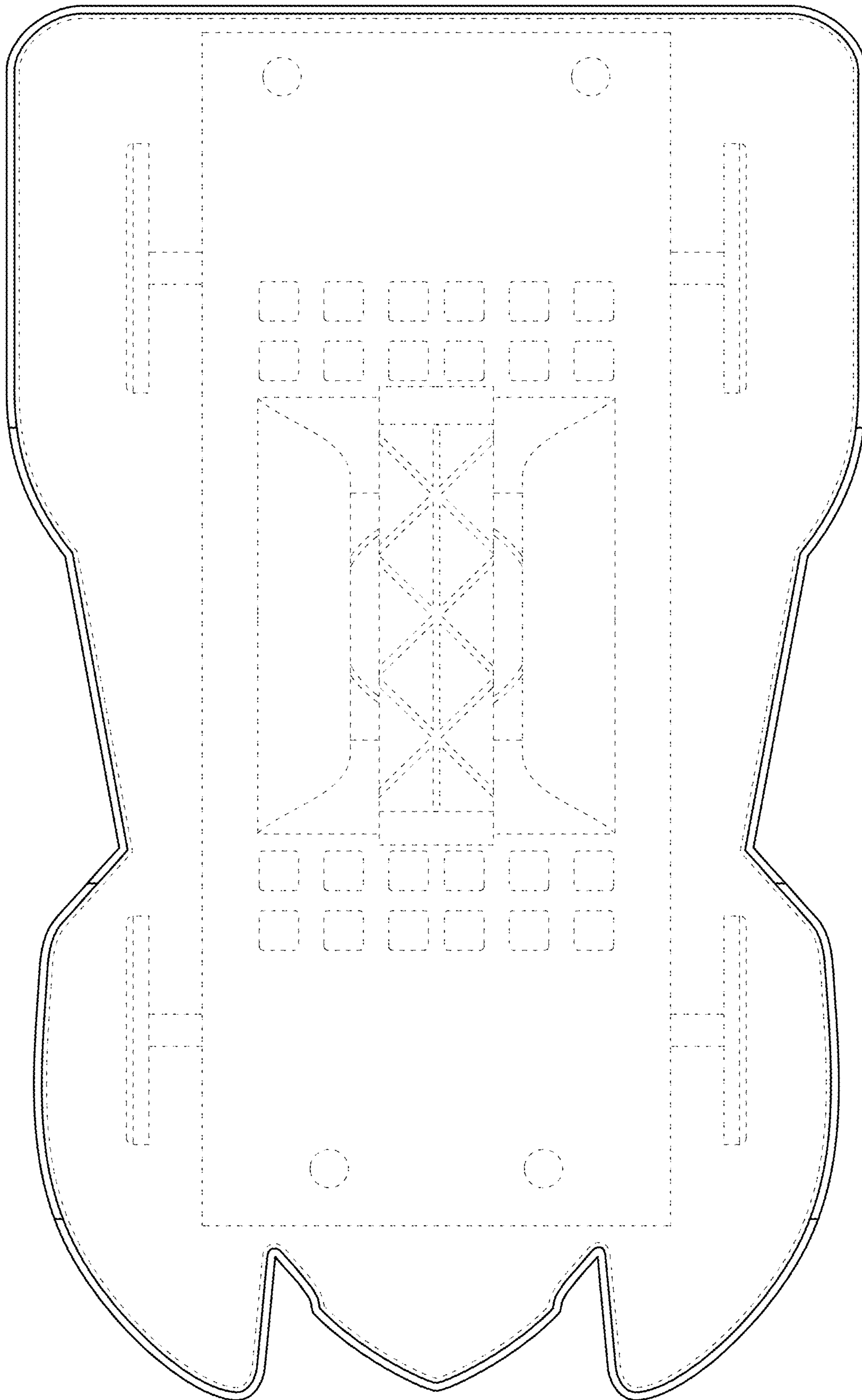

FIG. 7