



US00D929500S

(12) **United States Design Patent** (10) **Patent No.:** **US D929,500 S**
Schneider et al. (45) **Date of Patent:** **** Aug. 31, 2021**

(54) **CARD WITH TEXTURED GRIP**
(71) Applicant: **Capital One Services, LLC**, McLean, VA (US)
(72) Inventors: **Stephen Schneider**, Midlothian, VA (US); **Tyler Maiman**, Melville, NY (US)
(73) Assignee: **Capital One Services, LLC**, McLean, VA (US)
(**) Term: **15 Years**
(21) Appl. No.: **29/690,626**
(22) Filed: **May 9, 2019**
(51) **LOC (13) Cl.** **19-08**
(52) **U.S. Cl.**
USPC **D19/10**
(58) **Field of Classification Search**
USPC D19/1-12, 20-34, 100;
40/124.01-124.15, 672, 661, 726, 776,
40/617; 283/72, 74-75, 103, 105-117,
283/82, 70, 94, 81, 907; 206/449;
D21/385; D20/10, 22, 27, 40, 42, 11;
D14/435-437; 235/380, 382, 487, 493,
235/488; D6/613, 583; 360/2; 702/158,
702/86, 97, 163, 166, 170
CPC B42D 15/00; B42D 15/022; B42D 15/027;
B42D 15/042; B42D 15/045; B42D
25/00; B42D 25/20; B42D 25/30; B42D
25/23; B42D 25/26; B42D 25/29; B42D
25/285; B42D 2033/00; B42D 2033/02;
B42D 2033/04; B42D 2033/08; B42D
2033/10; B42D 2033/18; B42D 2033/20;
B42D 2033/22; B42D 2033/28
See application file for complete search history.

(56) **References Cited**
U.S. PATENT DOCUMENTS
7,273,234 B1 9/2007 Collins et al.
D604,359 S * 11/2009 Santos D19/9
D837,878 S * 1/2019 Lansdale D19/10
D902,993 S * 11/2020 Beeler D19/10
2006/0255155 A1 11/2006 Cranston et al.
2010/0276920 A1 11/2010 Woodman et al.
* cited by examiner
Primary Examiner — Abraham Bahta
(74) *Attorney, Agent, or Firm* — Kacvinsky Daisak Bluni PLLC

(57) **CLAIM**
The ornamental design for a card with textured grip, as shown and described.

DESCRIPTION
FIG. 1A is a bottom isometric view of the card with textured grip, showing our new design;
FIG. 1B is an enlarged portion of the card with textured grip, as indicated in FIG. 1A;
FIG. 2 is a top view thereof;
FIG. 3 is a bottom view thereof;
FIG. 4 is a first end view thereof;
FIG. 5 is a second end view thereof;
FIG. 6 is a first side view thereof; and,
FIG. 7 is a second side view thereof.
The broken lines showing portions of the card with textured grip form no part of the claimed design.

1 Claim, 6 Drawing Sheets

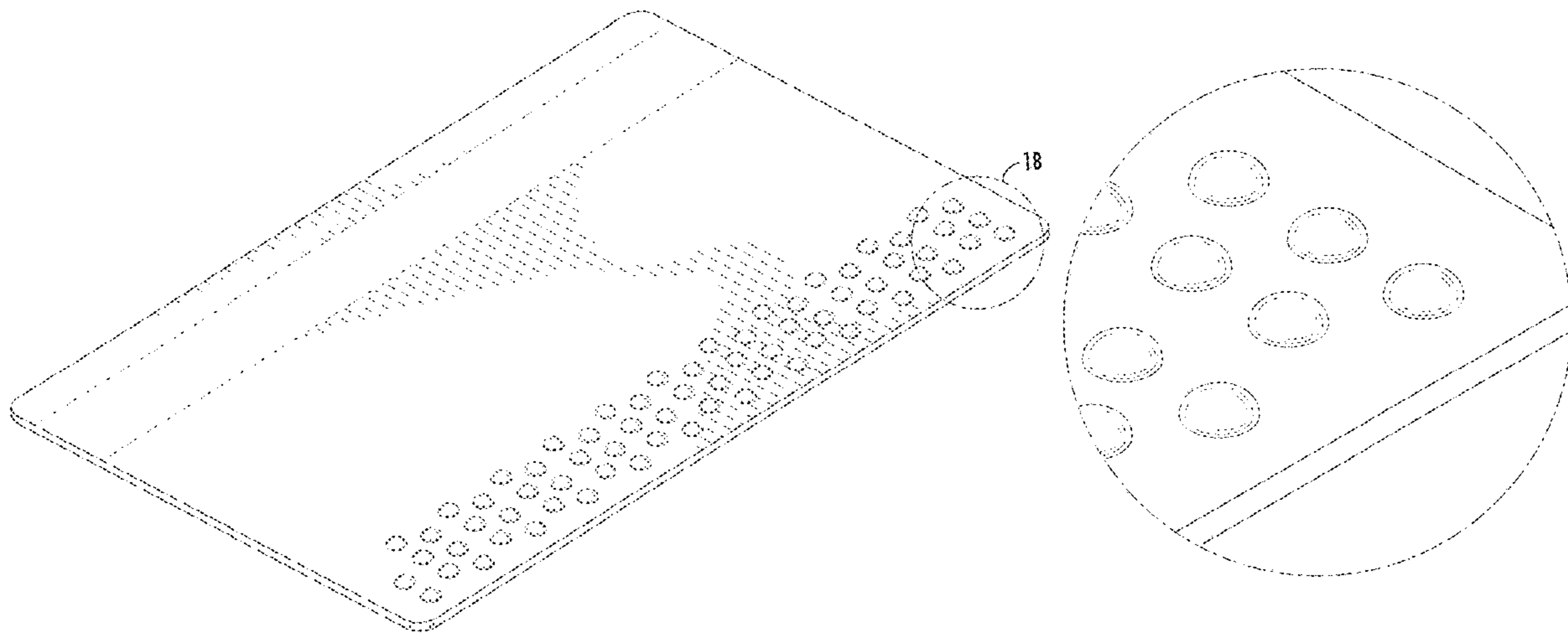

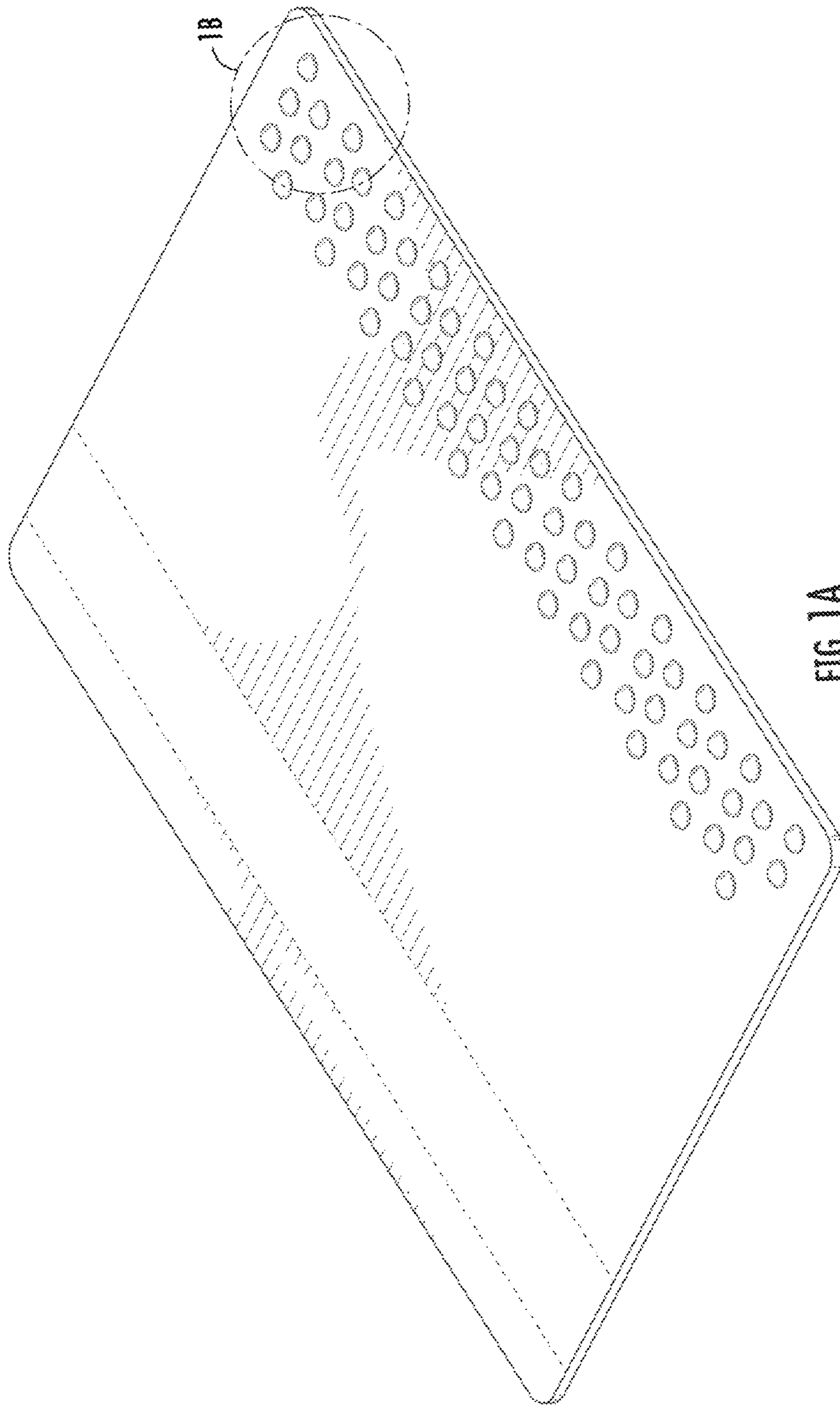

FIG. 1A

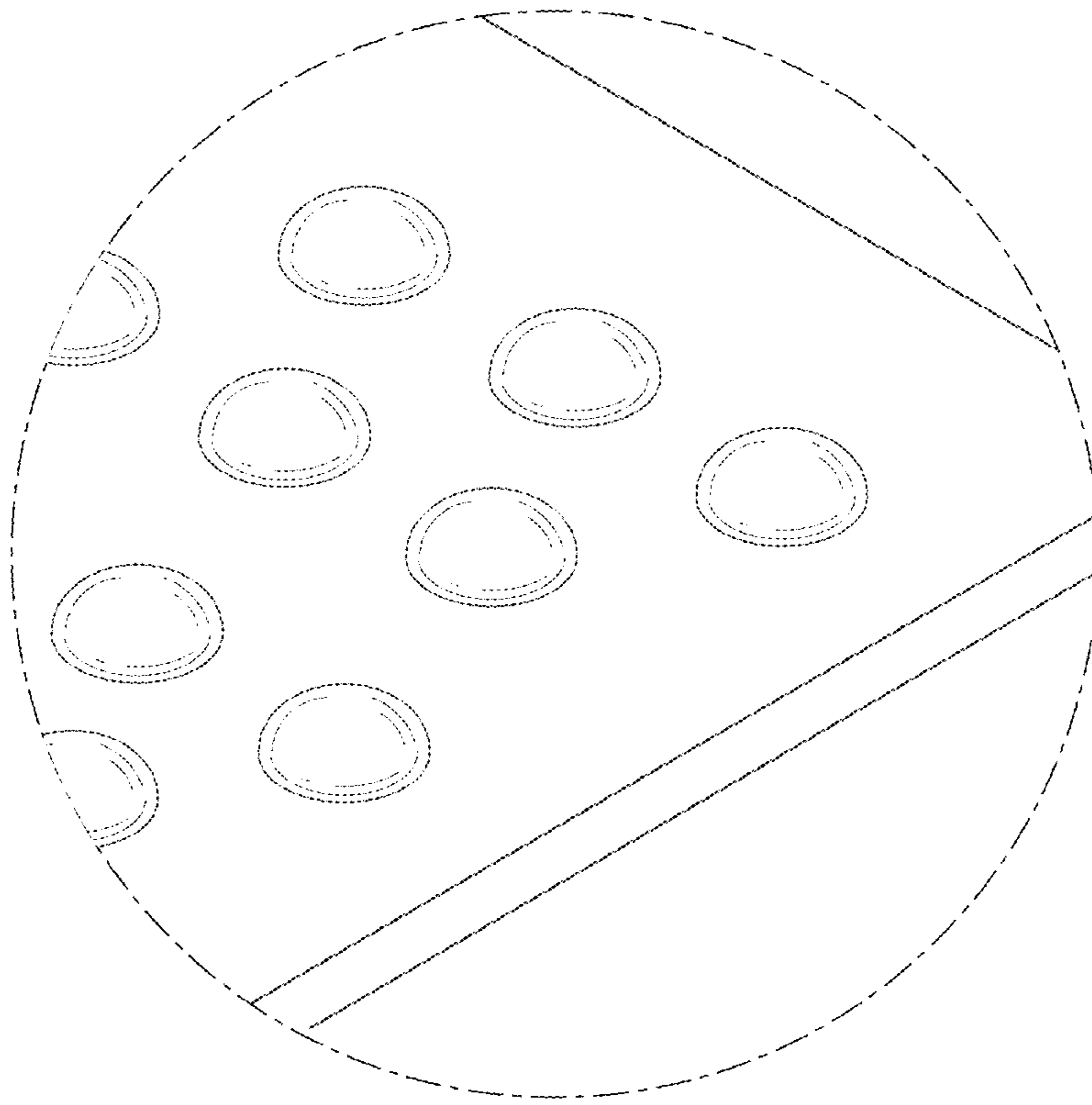

FIG. 1B

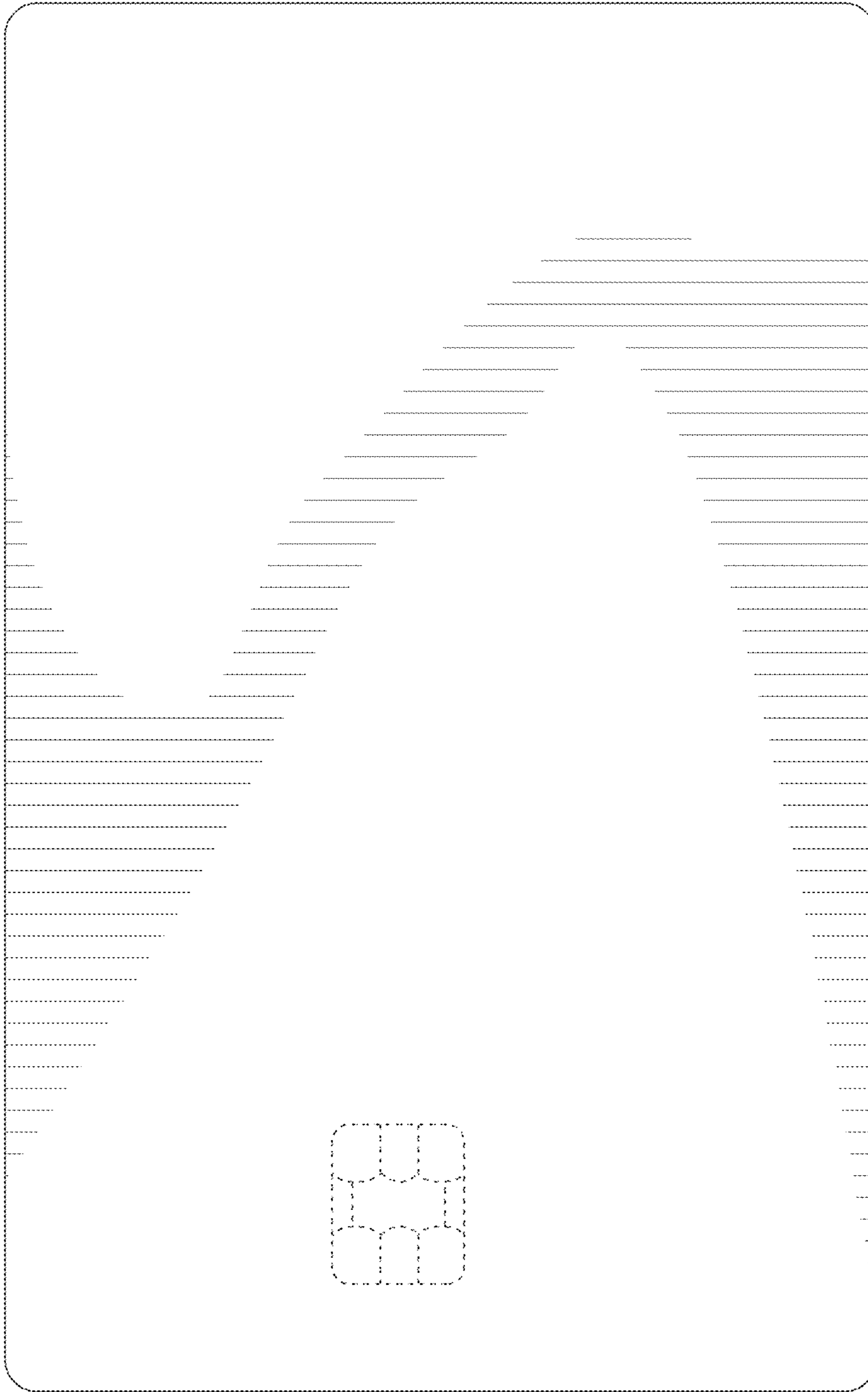

FIG. 2

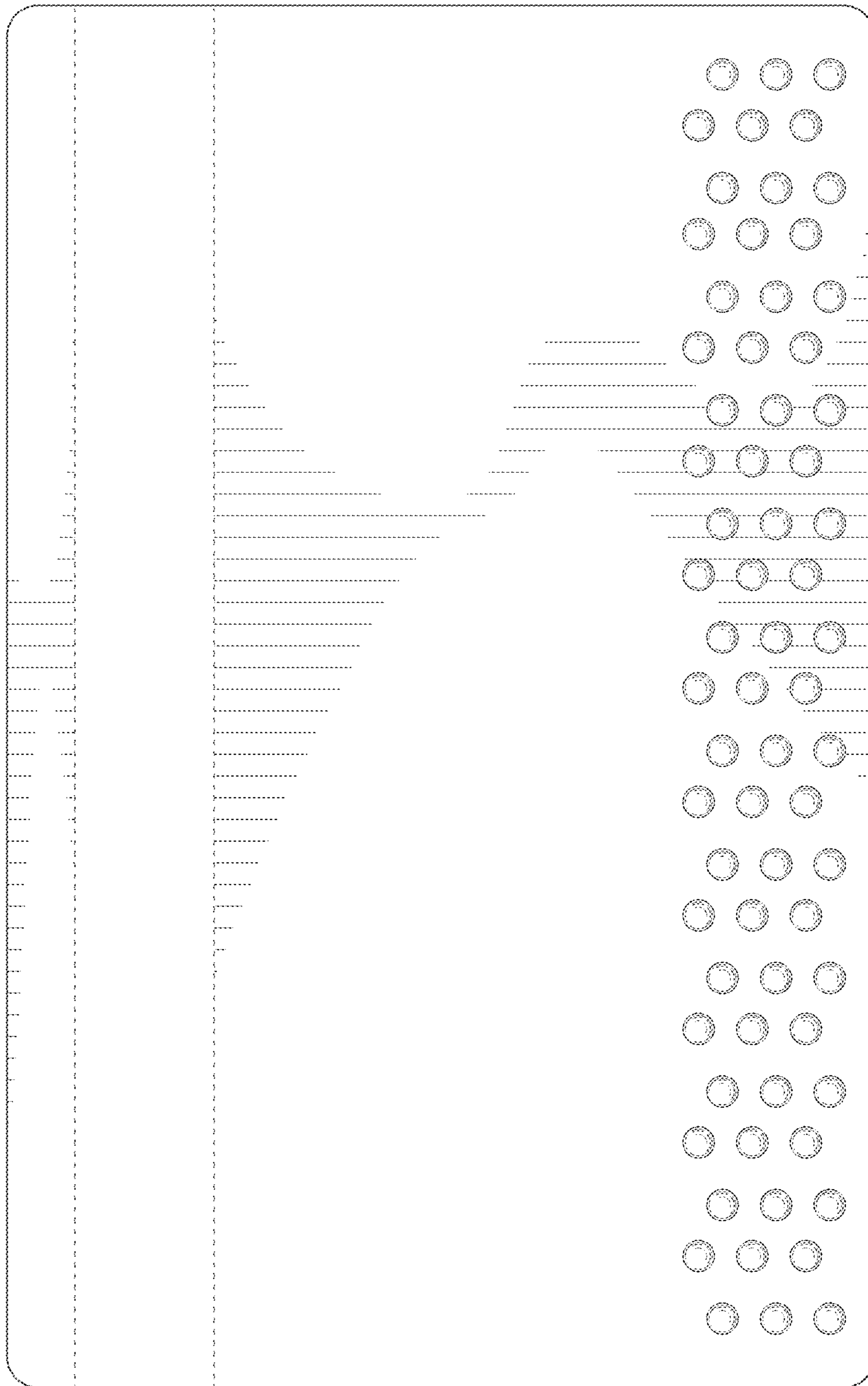

FIG. 3

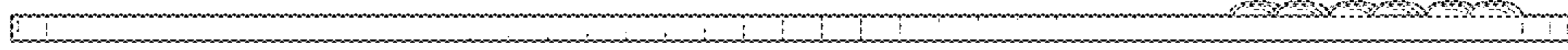

FIG. 4

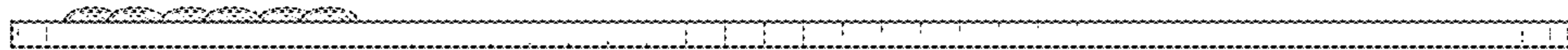

FIG. 5

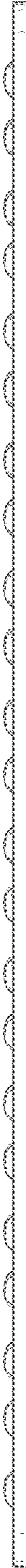

FIG. 6



FIG. 7