



US00D929469S

(12) **United States Design Patent** (10) **Patent No.:** **US D929,469 S**
Rajopadhye et al. (45) **Date of Patent:** **** Aug. 31, 2021**

(54) **PANEL OF A HARVESTER**

FOREIGN PATENT DOCUMENTS

(71) Applicant: **Deere & Company**, Moline, IL (US)

CN 302092321 S 9/2012
CN 302220180 S 12/2012

(72) Inventors: **Dhananjay Rajopadhye**, Pune (IN);
Paul M. Richardel, Polk City, IA (US);
Paul J. McCredie, Bettendorf, IA (US);
Shantanu Acharya, Pune (IN); **Vivek**
Vedpathak, Pune (IN); **Omkar**
Thurumalla, Mississauga (CA); **Felix**
Nagelin, Malibu, CA (US); **Tobias**
Adami, Munich (DE)

OTHER PUBLICATIONS

Deere & Company, Grain Harvesting Combines and Front End
Equipment, Brochure, Oct. 2018.

(Continued)

Primary Examiner — Mark A Goodwin

(74) *Attorney, Agent, or Firm* — Klintworth & Rozenblat
IP LLP

(73) Assignee: **DEERE & COMPANY**, Moline, IL
(US)

(**) Term: **15 Years**

(57) **CLAIM**

(21) Appl. No.: **29/724,291**

The ornamental design for a panel of a harvester, as shown
and described.

(22) Filed: **Feb. 13, 2020**

Related U.S. Application Data

DESCRIPTION

(63) Continuation of application No. 29/712,598, filed on
Nov. 8, 2019, now Pat. No. Des. 914,066.

(30) **Foreign Application Priority Data**

May 9, 2019 (EM) 006437083

(51) **LOC (13) Cl.** **15-03**

(52) **U.S. Cl.**
USPC **D15/28**

(58) **Field of Classification Search**
USPC D15/10-12, 22-26, 28; 56/14.5-14.7,
56/16.6, 122-125

(Continued)

FIG. 1 is a perspective view of a panel of a harvester
according to our new design;
FIG. 2 is a first side elevational view thereof;
FIG. 3 is a second side elevational view thereof;
FIG. 4 is a first end elevational view thereof;
FIG. 5 is a second end elevational view thereof;
FIG. 6 is a first plan view thereof;
FIG. 7 is a second plan view thereof;
FIG. 8 is a perspective view of a panel of a harvester
according to another embodiment of our new design;
FIG. 9 is a first side elevational view thereof;
FIG. 10 is a second side elevational view thereof;
FIG. 11 is a first end elevational view thereof;
FIG. 12 is a second end elevational view thereof;
FIG. 13 is a first plan view thereof; and,
FIG. 14 is a second plan view thereof.

The dashed lines depict environment subject matter that
forms no part of the claimed design.

(56) **References Cited**

U.S. PATENT DOCUMENTS

4,502,270 A 3/1985 Shupert
D373,591 S * 9/1996 Von Allworden D15/26

(Continued)

1 Claim, 10 Drawing Sheets

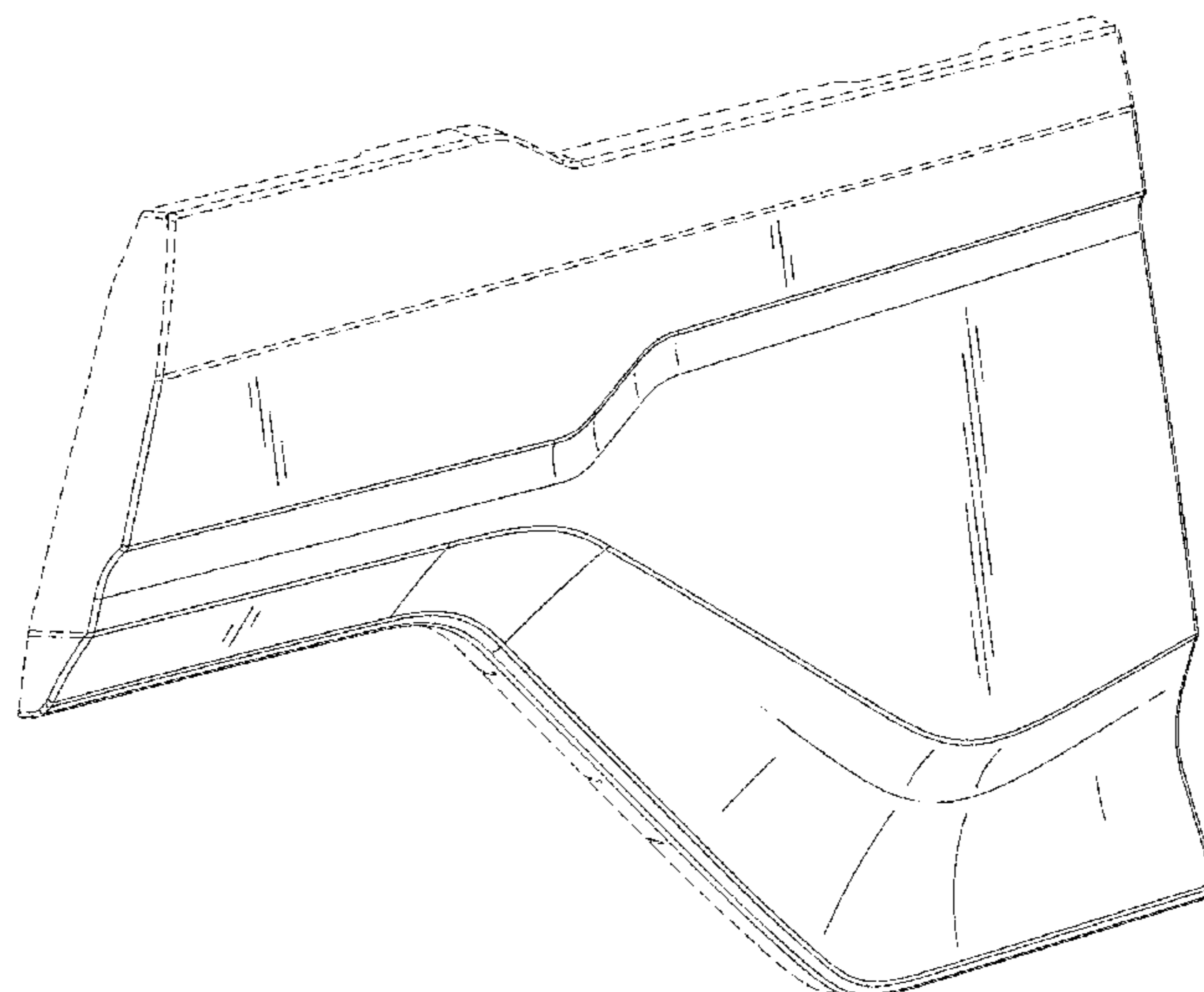

(58) **Field of Classification Search**

CPC A01B 73/00; A01D 75/00; A01D 41/06;
 A01D 41/1208; A01D 41/00; A01D
 67/00; A01D 45/00; A01D 45/02; A01D
 45/021; A01D 43/081

See application file for complete search history.

(56) **References Cited**

U.S. PATENT DOCUMENTS

D639,826	S	*	6/2011	Barrelmeyer	D15/26
D643,052	S	*	8/2011	Hagele	D15/33
D648,357	S	*	11/2011	Hagele	D15/33
D717,345	S	*	11/2014	Budde	D15/26
D736,271	S	*	8/2015	Jacobsthal	D15/33
D743,450	S	*	11/2015	Claeys	D15/33
D746,342	S	*	12/2015	Jacobsthal	D15/33
D794,086	S	*	8/2017	Thompson	D15/26
D826,994	S	*	8/2018	De Smet	D15/26
D879,843	S	*	3/2020	Gonzales	D15/33
D880,539	S	*	4/2020	Depoorter	D15/33
2017/0086374	A1		3/2017	Engel		

OTHER PUBLICATIONS

Claas of America, Improves Profitability with Increasing Revenue, Google Search, <https://www.serbia.claas.com/news-testimonials/current/claas-news/claas-improves-profitability-with-increasing-revenue-/1904264>, 2019.

Claas of America, photograph of header, 2017.

New Holland, Overview—Corn Heads Leading From the Front, Combines & Headers, <https://agriculture.newholland.com/nar/en-us/equipment/products/combines-and-headers/com-heads>, 2019.

Macdon Industries Ltd, D65 Draper Header, Draper Headers for Combine, <https://www.macdon.com/en/products/d65-draper-headers-for-combine/>, 2019.

New Holland, Draper Heads—Overview Combines & Headers New Holland (US) NHAG, <https://agriculture.newholland.com/nar/en-us/equipment/products/combines-and-headers/draper-heads>, 2019.

Case IH, Draper Heads Combine Harvester, Case IH 3100 Series II Draper Heads, <https://www.caseih.com/northamerica/en-us/products/harvesting/draper-heads>, Copyright 2020.

Massey Ferguson, 9250 DynaFlex Draper Header, <http://www.masseyferguson.us/products/combine-harvesting/9250-dynaflex-draper-headers.html#0>, Copyright 2020.

* cited by examiner

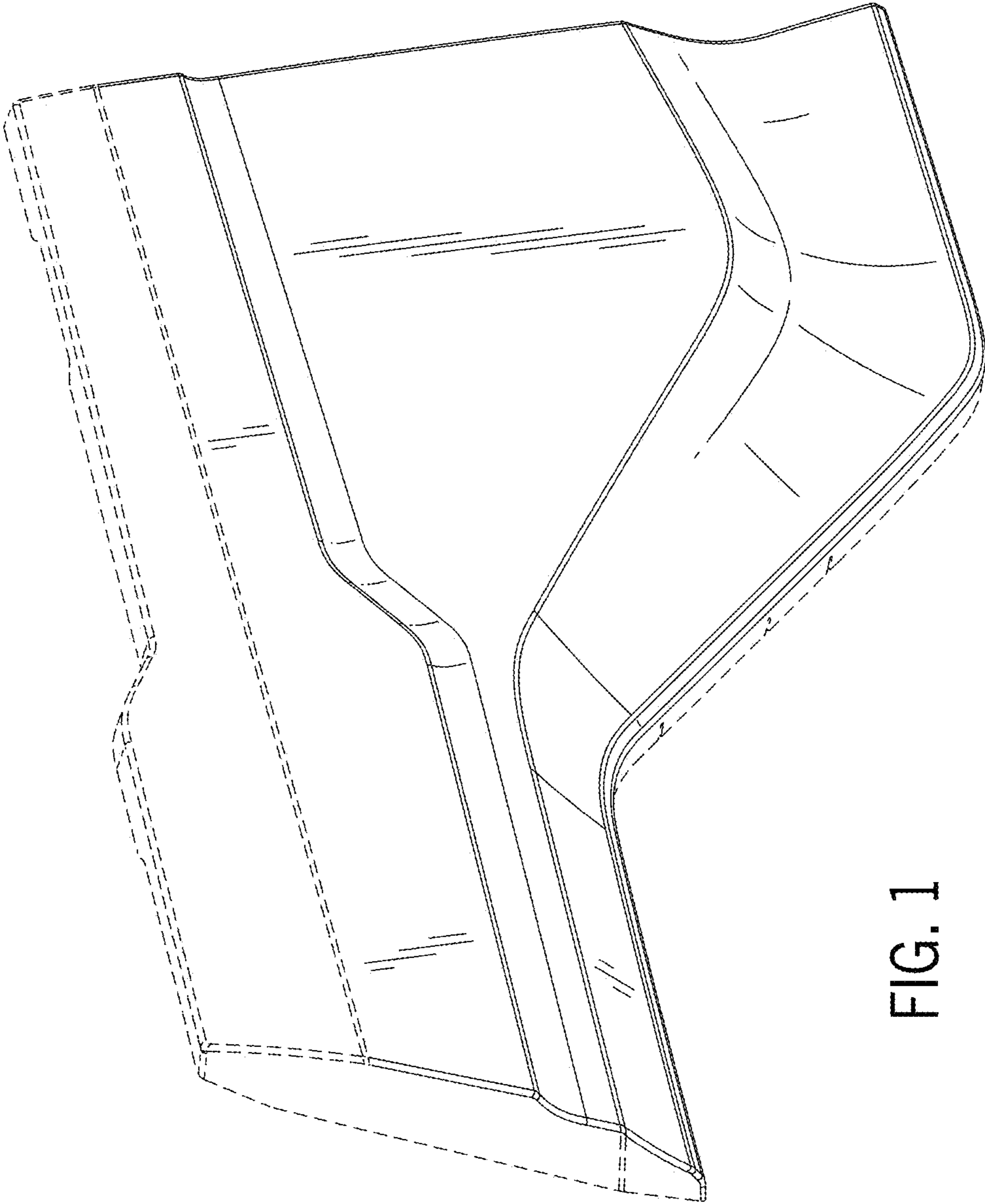

FIG. 1

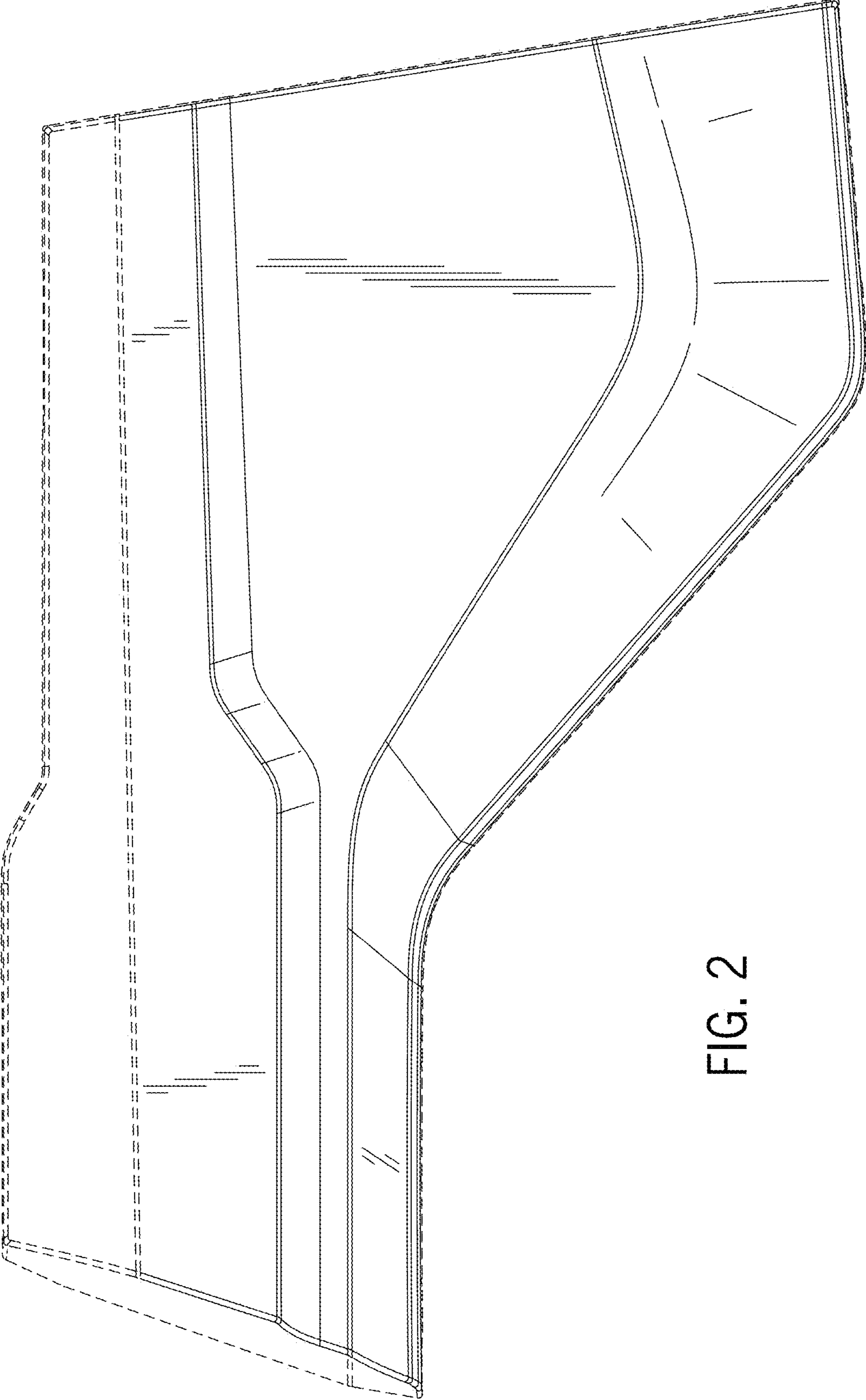

FIG. 2

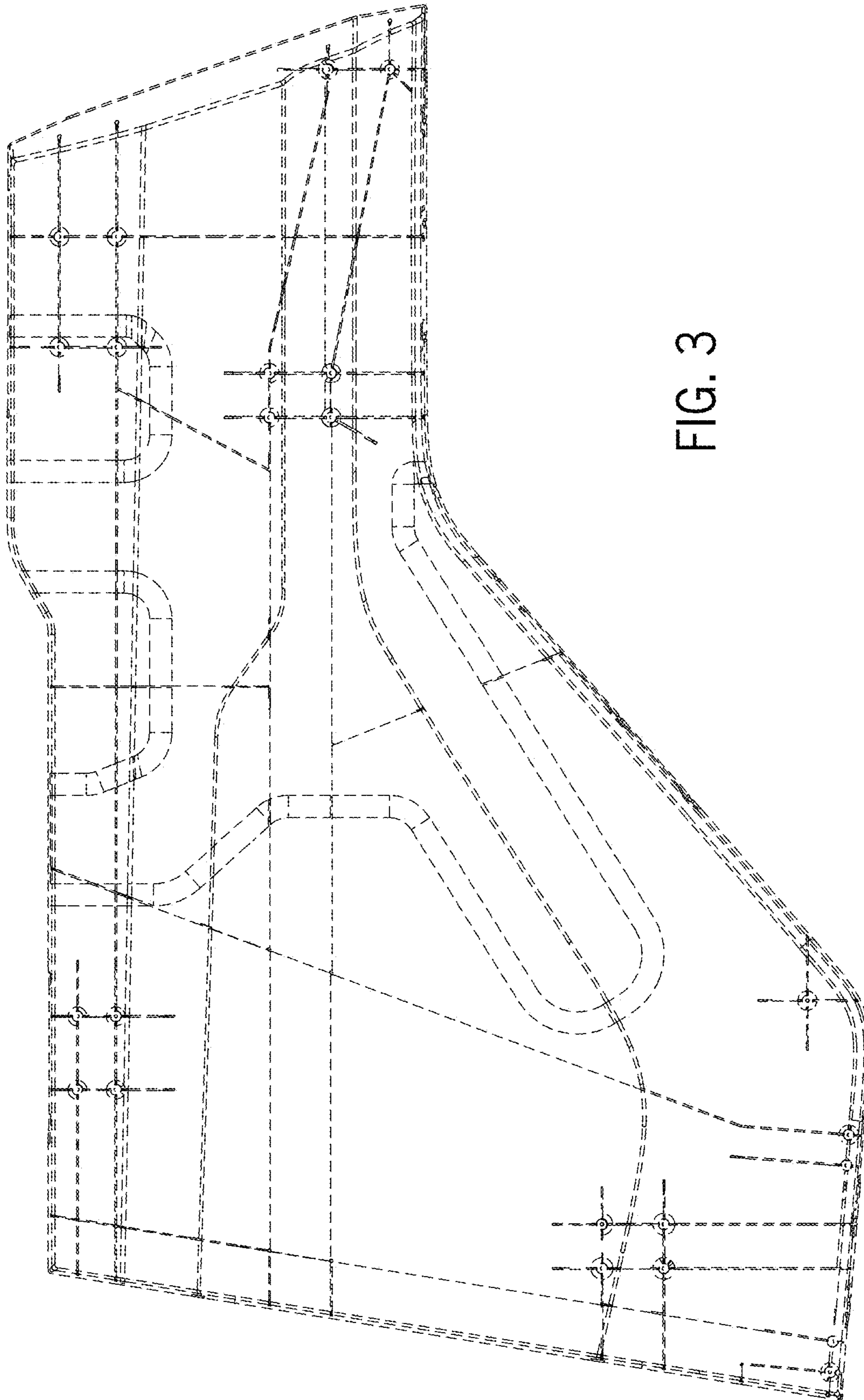

FIG. 3

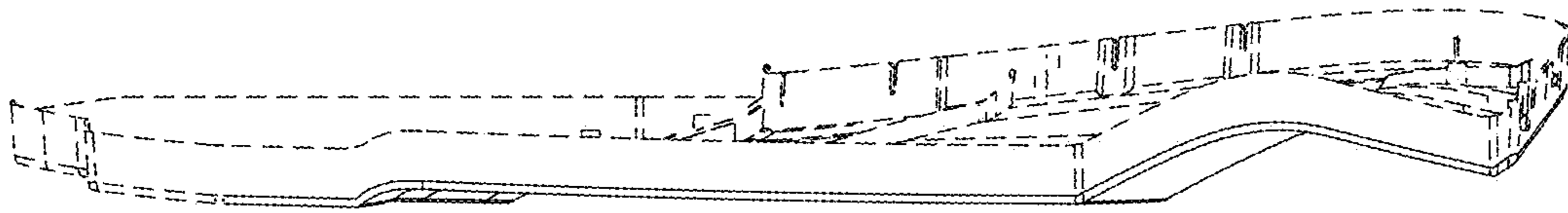

FIG. 5

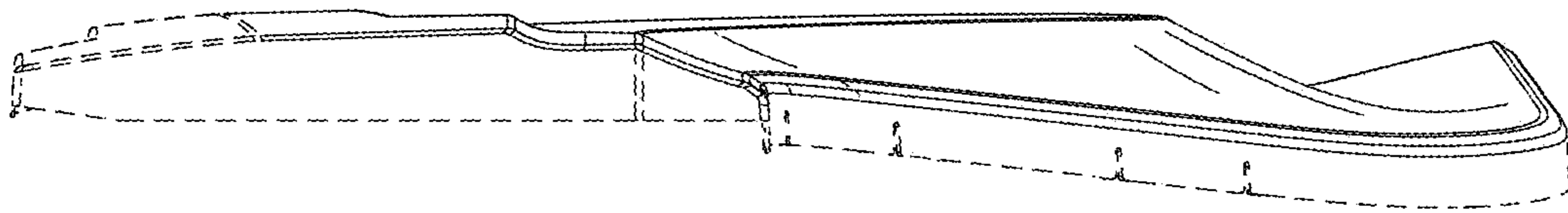

FIG. 4

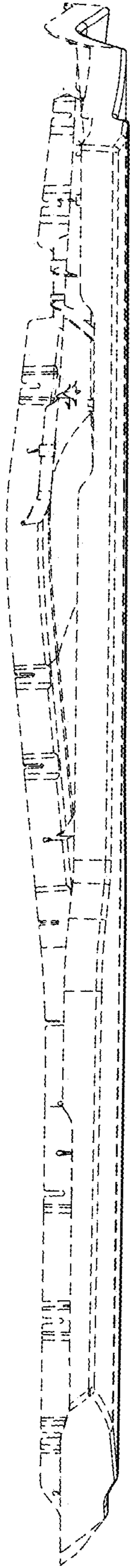

FIG. 6

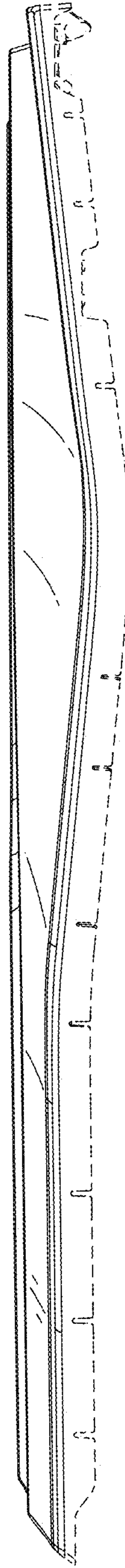

FIG. 7

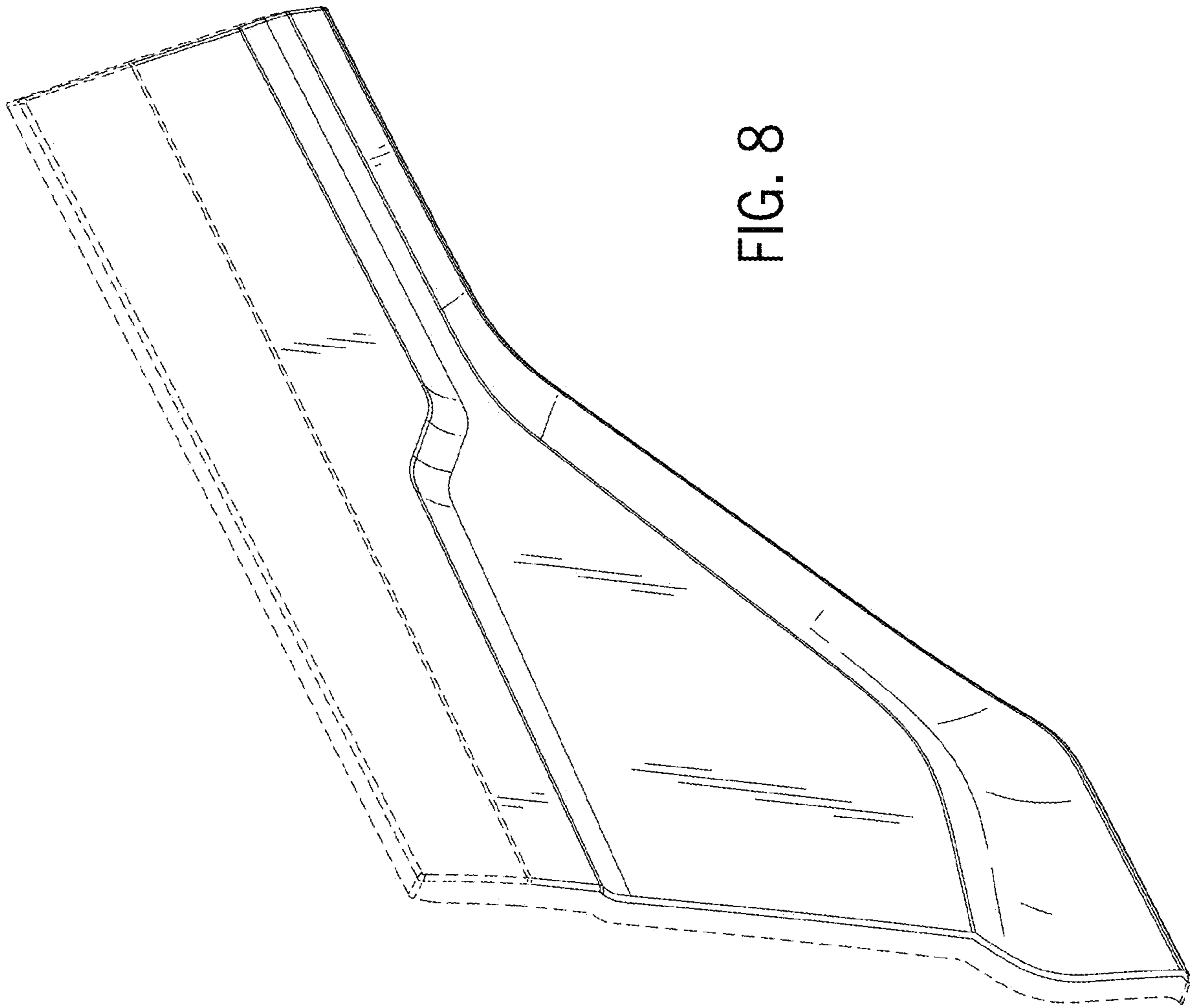

FIG. 8

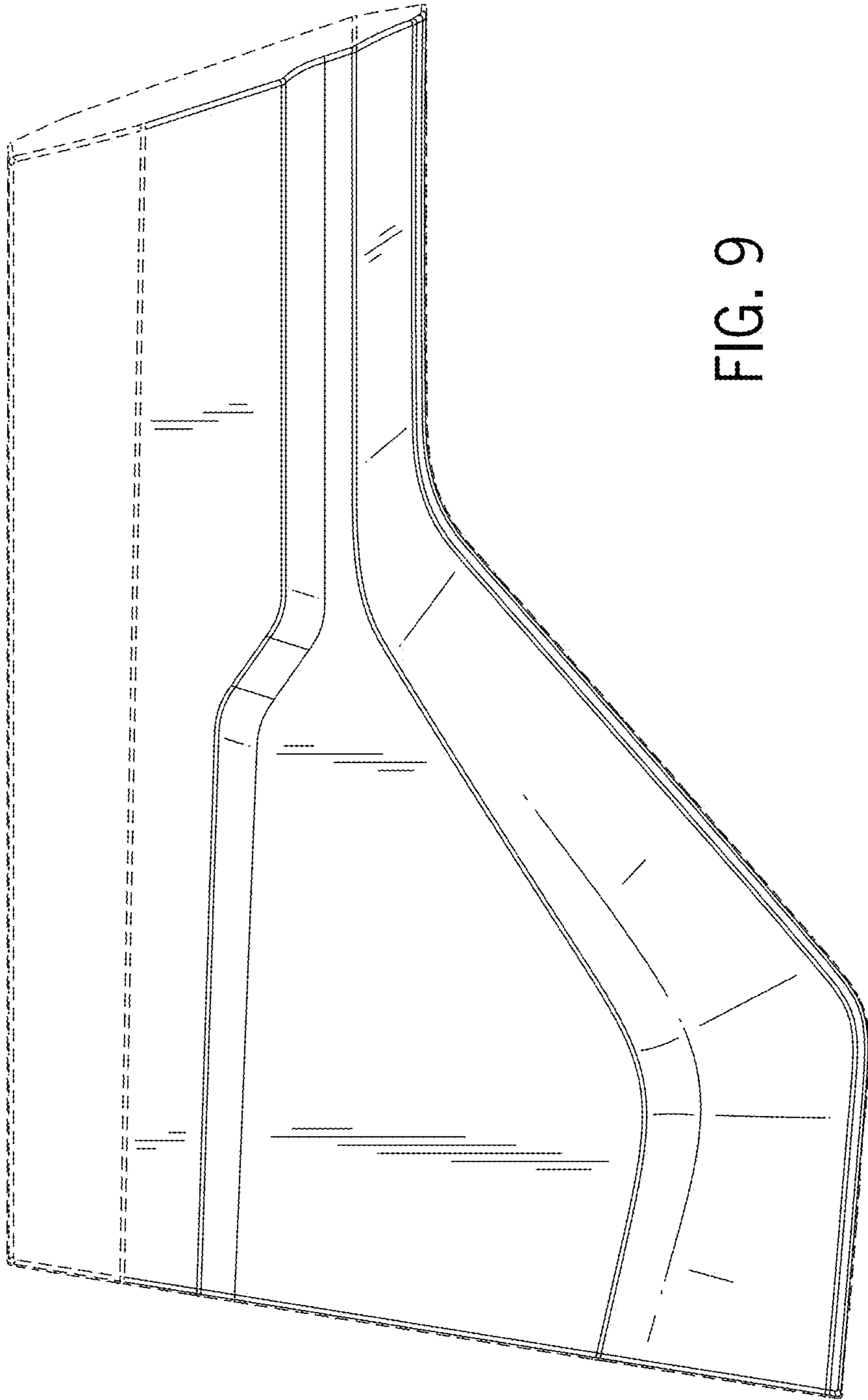

FIG. 9

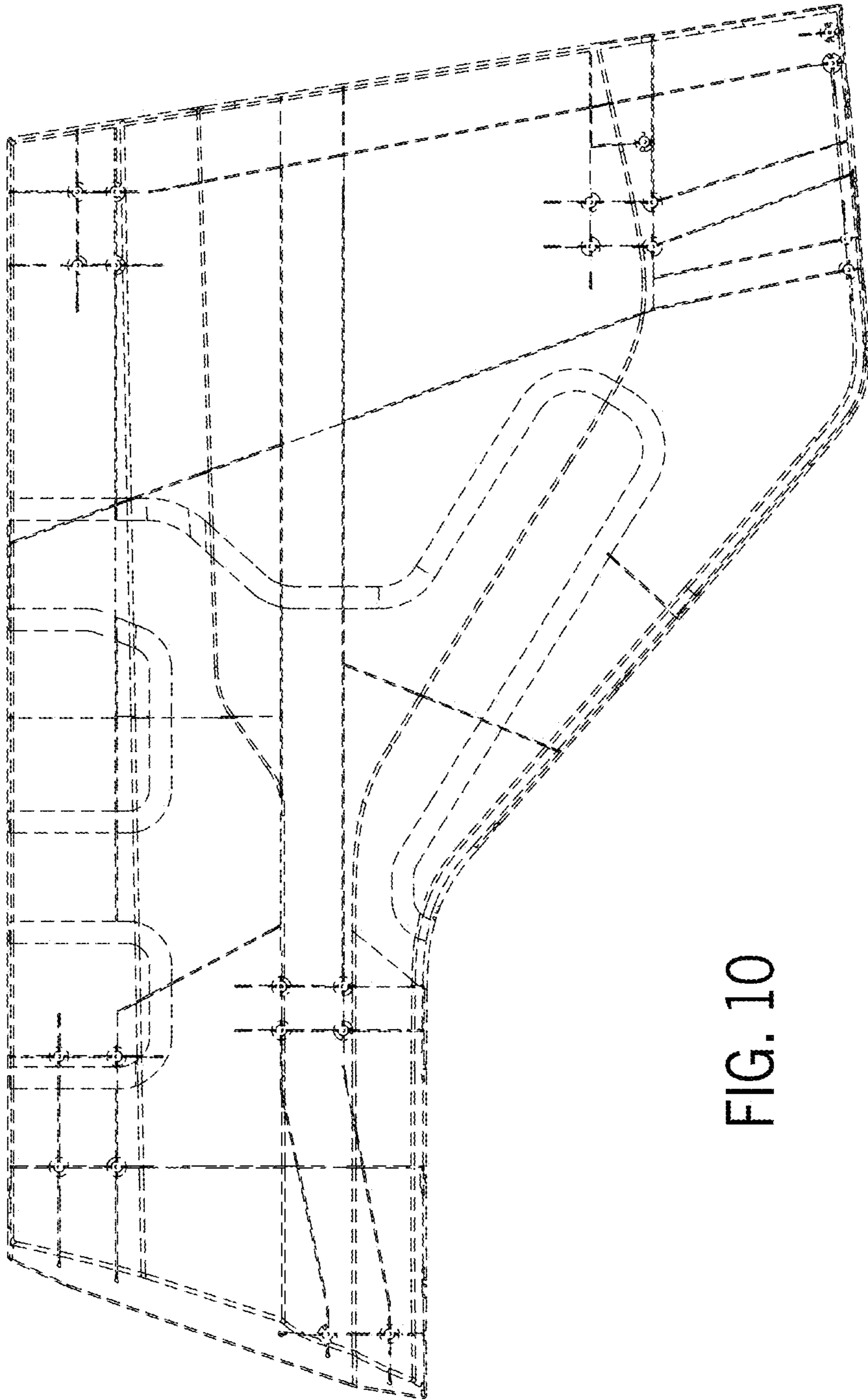

FIG. 10

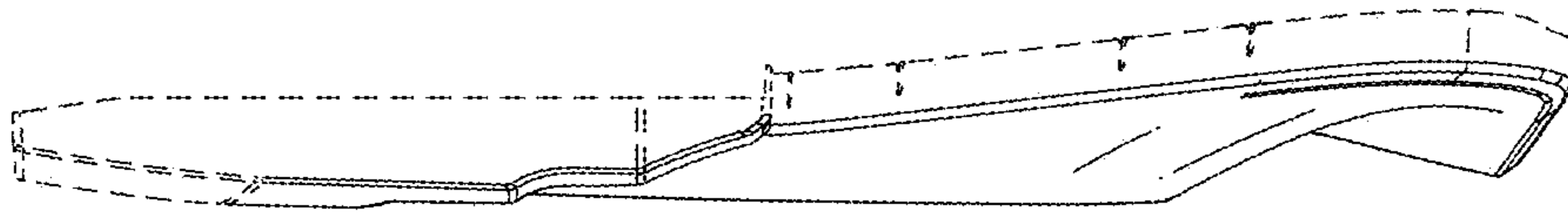

FIG. 12

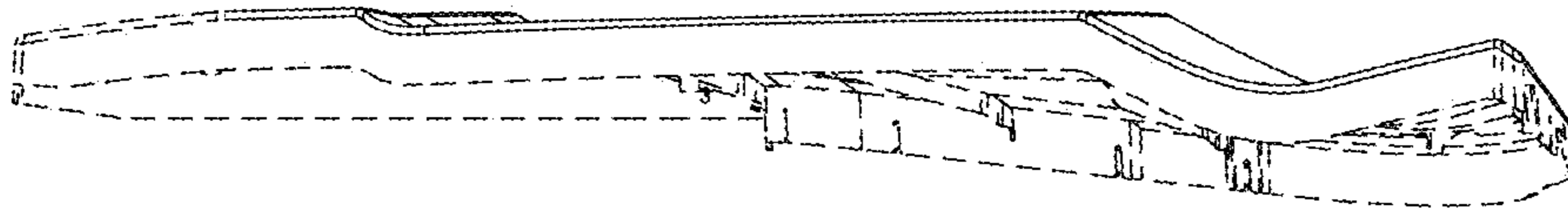

FIG. 11

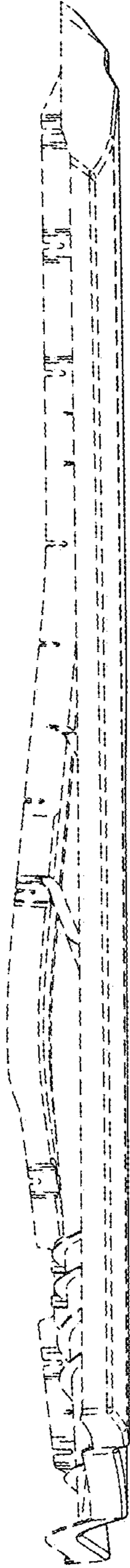

FIG. 13

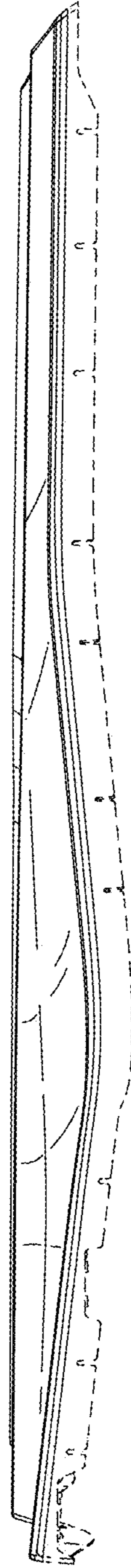

FIG. 14