



US00D929465S

(12) **United States Design Patent**
Pelini

(10) **Patent No.:** **US D929,465 S**

(45) **Date of Patent:** **** Aug. 31, 2021**

(54) **HYDRAULIC CYLINDER WITH
FREE-FLOATING PUMP AND RESERVOIR**

(71) Applicant: **Mark F. Pelini**, Valrico, FL (US)

(72) Inventor: **Mark F. Pelini**, Valrico, FL (US)

(**) Term: **15 Years**

(21) Appl. No.: **29/726,449**

(22) Filed: **Mar. 3, 2020**

Related U.S. Application Data

(63) Continuation-in-part of application No. 29/723,616, filed on Feb. 8, 2020, and a continuation-in-part of application No. 29/723,614, filed on Feb. 8, 2020, now Pat. No. Des. 918,837, and a continuation-in-part of application No. 29/723,615, filed on Feb. 8, 2020, now Pat. No. Des. 918,838.

(51) **LOC (13) Cl.** **15-02**

(52) **U.S. Cl.**
USPC **D15/7**

(58) **Field of Classification Search**
USPC D15/4, 5, 7, 8, 9, 9.1, 9.2, 9.3, 143, 148,
D15/199; D13/112, 122, 199
CPC B63H 20/08; B63H 20/106; B63H 5/125;
F15B 15/04; F15B 15/12; F15B 15/18;
F15B 15/106; F15B 15/063; F15B 1/106;
F15B 1/265; F15B 2211/20515; B66F
9/22; F04B 47/08
See application file for complete search history.

(56) **References Cited**

U.S. PATENT DOCUMENTS

D354,495 S * 1/1995 Tojo D15/7
D408,420 S * 4/1999 Buter D15/7

D419,567 S * 1/2000 Weiss D15/7
D461,827 S * 8/2002 Koebbe D15/7
6,435,073 B1 * 8/2002 Chen A63B 21/0083
482/53
D776,729 S * 1/2017 Wu D15/143
D802,639 S * 11/2017 Takagi D15/143
D804,553 S * 12/2017 Takagi D15/143
D888,774 S * 6/2020 Asahara D15/7
D899,465 S * 10/2020 Nemoto D15/7
2007/0062317 A1 * 3/2007 Nagai F16D 35/005
74/89

* cited by examiner

Primary Examiner — Derrick E Holland

(74) *Attorney, Agent, or Firm* — Edward P Dutkiewicz

(57) **CLAIM**

The ornamental design for a hydraulic cylinder with free-floating pump and reservoir, as shown and described.

DESCRIPTION

This application also claims the priority of utility patent application 15/954,393, filed on Apr. 16, 2018, and currently pending.

FIG. 1 is a front elevational view of a hydraulic cylinder free-floating pump and reservoir showing the new design; FIG. 2 is a rear elevational view thereof; FIG. 3 is a right side elevational view thereof; FIG. 4 is a left side elevational view thereof; FIG. 5 is a top plan view thereof; FIG. 6 is a bottom plan view thereof; and, FIG. 7 is a left and front perspective view thereof.

1 Claim, 4 Drawing Sheets

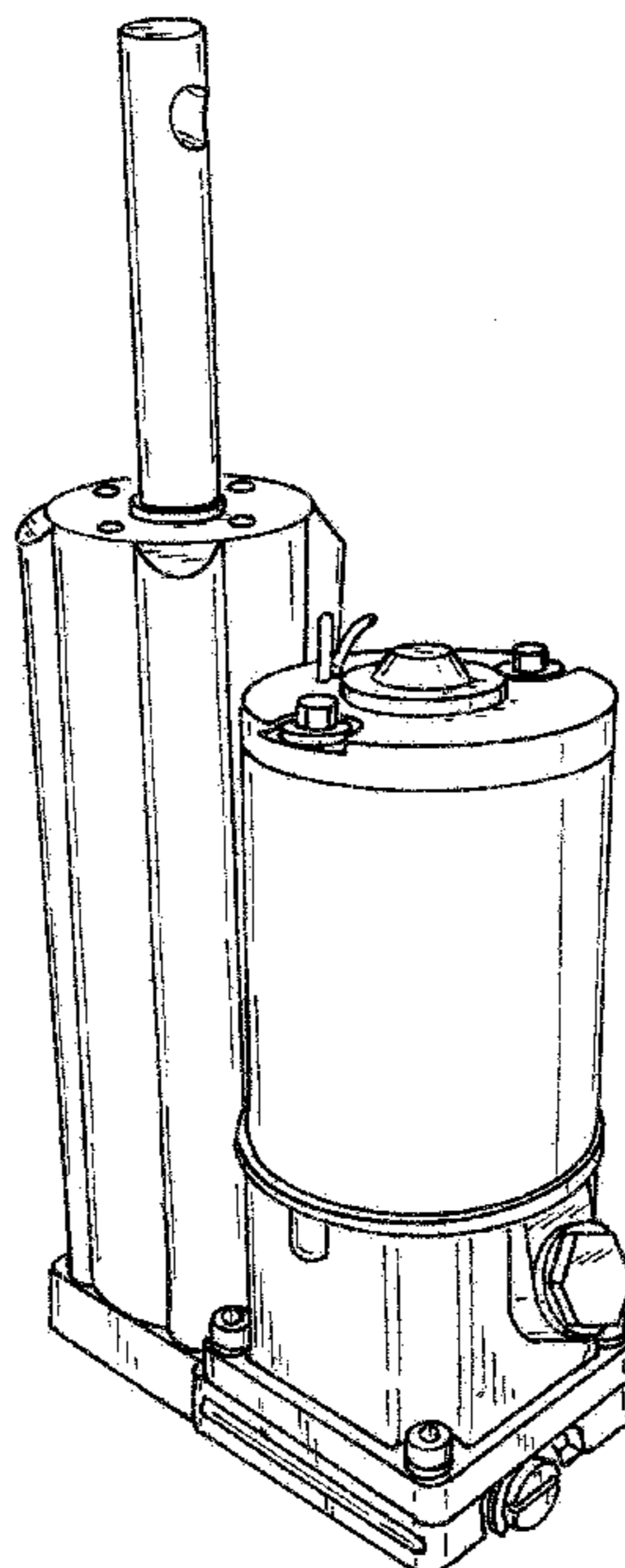

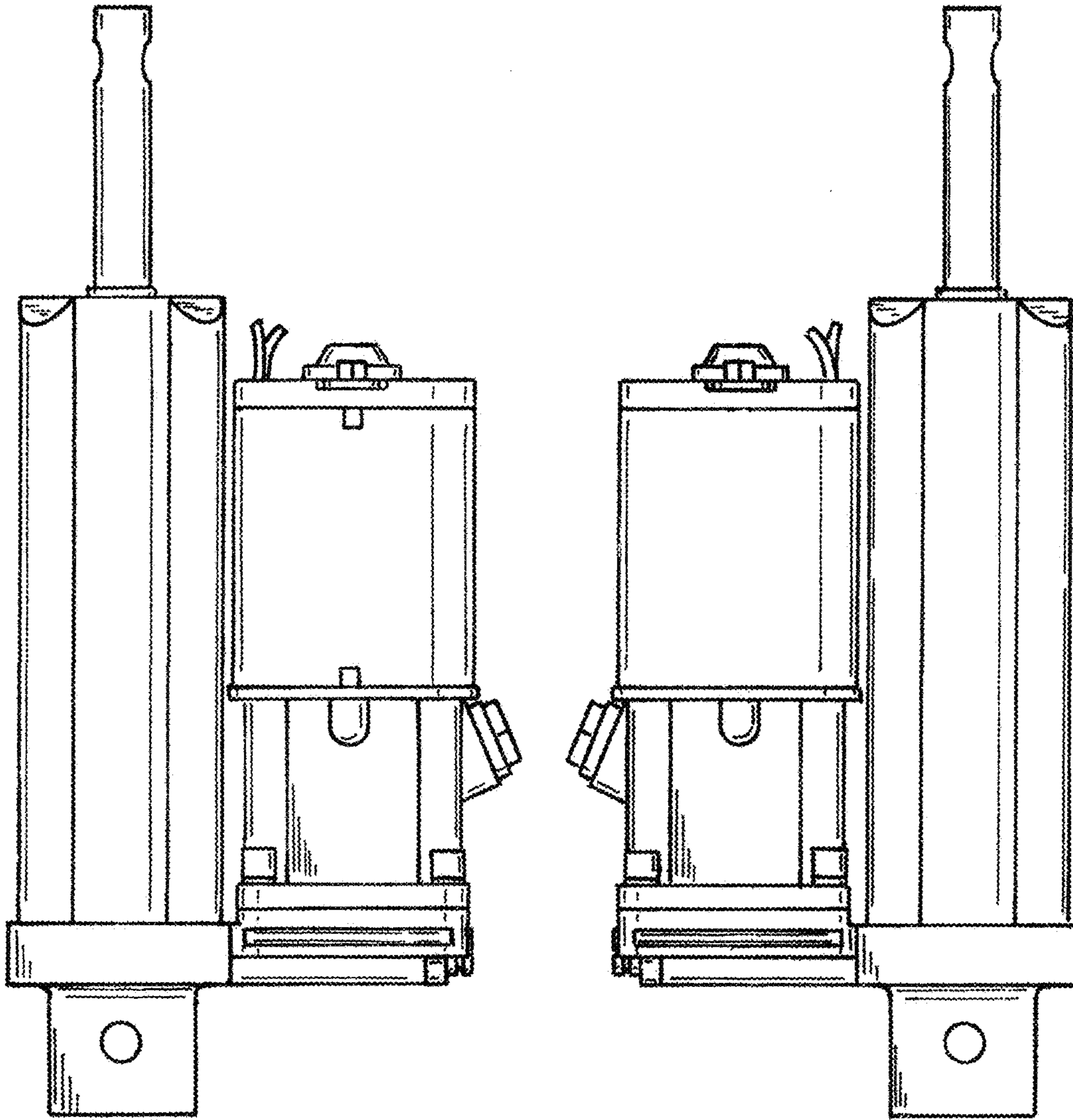

FIG. 1

FIG. 2

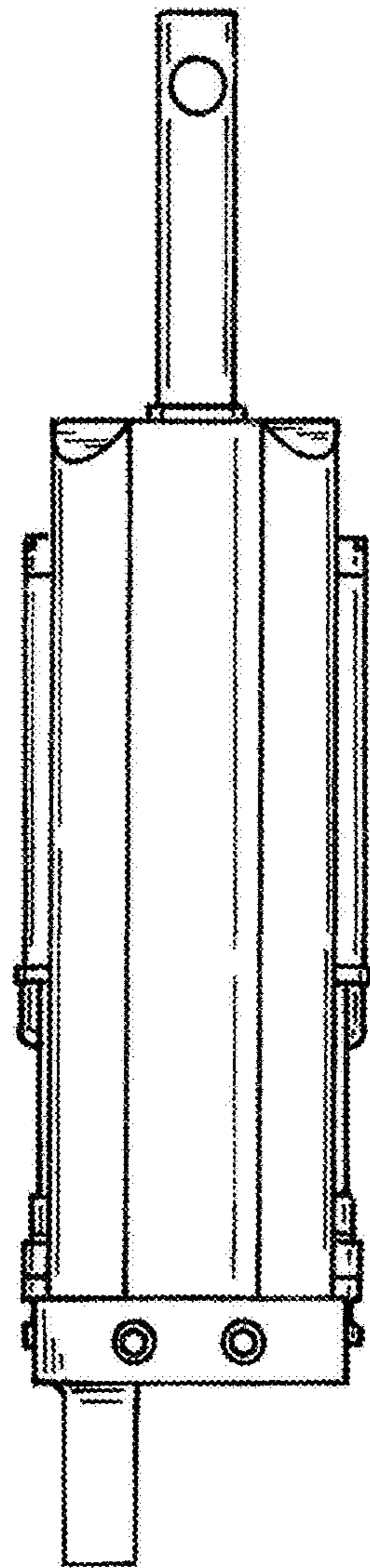

FIG. 3

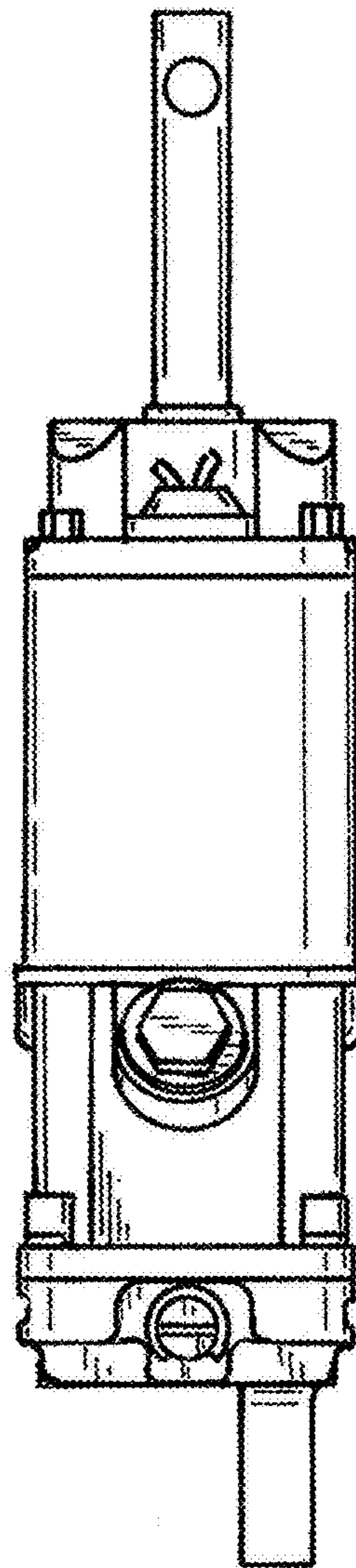

FIG. 4

FIG. 5

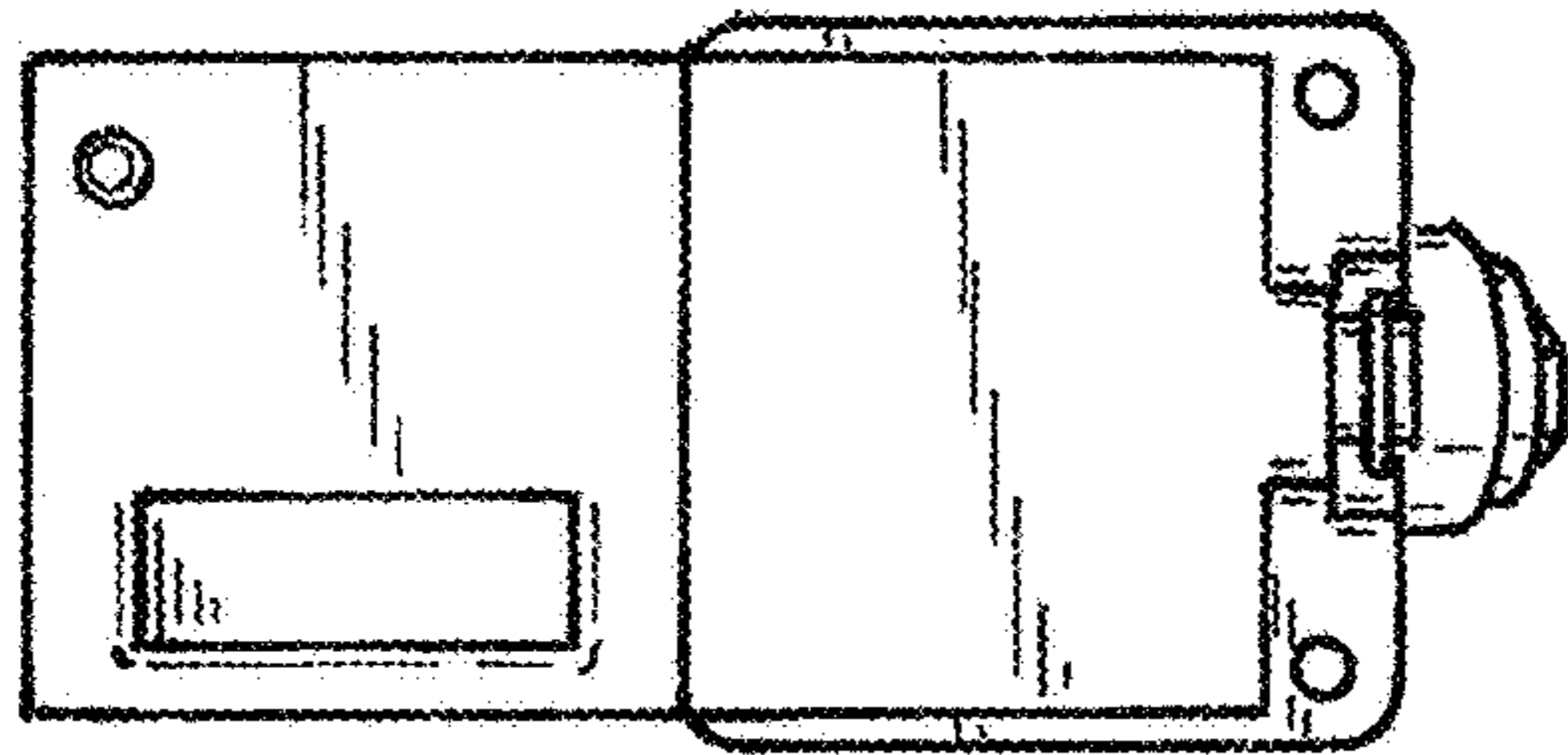
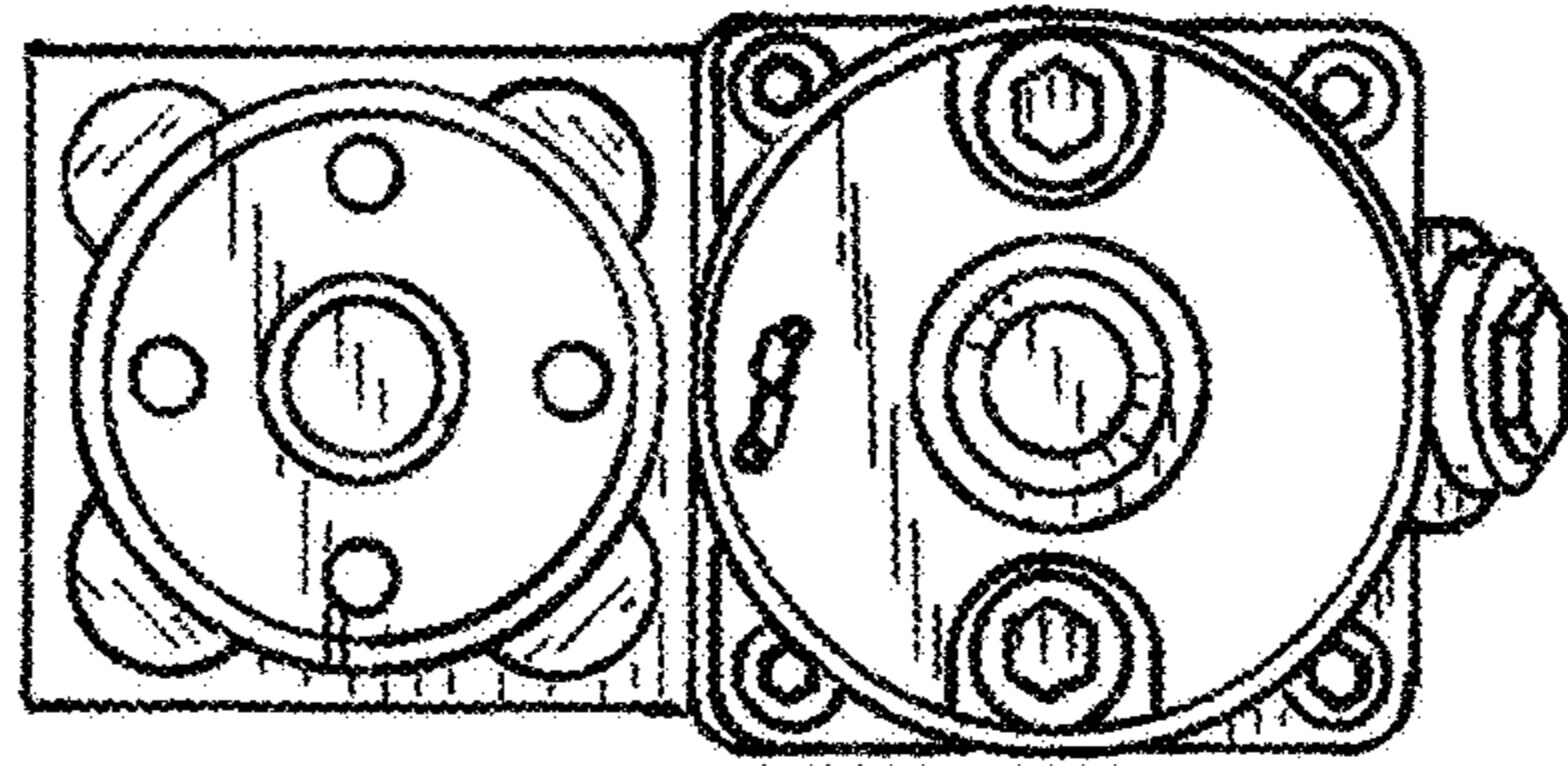

FIG. 6

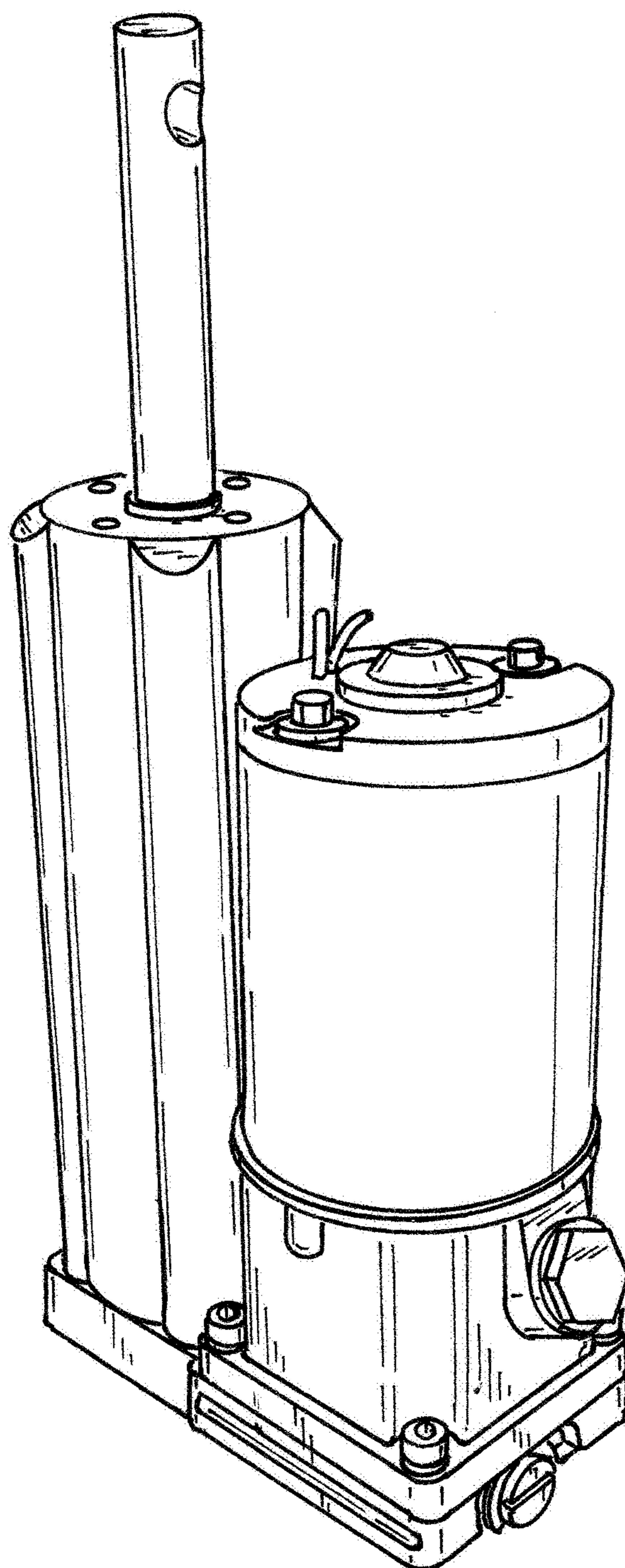

FIG. 7