



US00D929309S

(12) **United States Design Patent** (10) **Patent No.:** **US D929,309 S**
Ferrier et al. (45) **Date of Patent:** **** Aug. 31, 2021**

(54) **VEHICLE CENTER DISPLAY**

OTHER PUBLICATIONS

- (71) Applicant: **Ford Global Technologies, LLC**, Dearborn, MI (US)
- (72) Inventors: **Scott Ferrier**, Bloomfield Hills, MI (US); **Dustin Shedlarski**, Commerce Township, MI (US); **Paul Mutter**, Detroit, MI (US)
- (73) Assignee: **Ford Global Technologies, LLC**, Dearborn, MI (US)

Andrew Wendler, The 2021 Ford F-150, Spied Testing, Looks Pretty Evolutionary, May 8, 2019 <https://www.caranddriver.com/news/a27409108/2021-ford-f-150-pickup-spied/>.

* cited by examiner

Primary Examiner — Abraham Bahta

(74) *Attorney, Agent, or Firm* — Michael Spenner

(**) Term: **15 Years**

(57) **CLAIM**

(21) Appl. No.: **29/724,004**

The ornamental design for a vehicle center display, as shown and described.

(22) Filed: **Feb. 12, 2020**

(51) **LOC (13) Cl.** **12-16**

(52) **U.S. Cl.**

USPC **D12/415**

(58) **Field of Classification Search**

USPC D12/191–192, 415, 114, 345; D15/17, D15/28; D10/122–127, 102–103, 98, 46; D23/324

CPC .. B60H 1/3421; B60H 1/3428; B60H 1/3435; B60H 1/3442; B60H 1/345; B60H 1/3457; B60H 2001/3464; B60H 2001/3471; B60H 2001/2478; B60H 2001/3485

See application file for complete search history.

DESCRIPTION

FIG. 1 is a front elevational view of a vehicle center display, showing our new design;

FIG. 2 is a left side elevational view thereof;

FIG. 3 is a right side elevational view thereof;

FIG. 4 is a top plan view thereof;

FIG. 5 is a bottom plan view thereof;

FIG. 6 is a top, front and left side perspective view thereof; and,

FIG. 7 is a bottom, front and left side perspective view thereof.

The claimed design is indicated by the relatively dark portions in the figures. The de-emphasized and relatively light portions form no part of the claimed design.

(56) **References Cited**

U.S. PATENT DOCUMENTS

D573,508 S *	7/2008	Brown, Jr.	D12/190
D838,656 S *	1/2019	Tomasson	D12/415
D886,027 S *	6/2020	Engelmann	D12/415
D908,075 S *	1/2021	Park	D12/415

1 Claim, 7 Drawing Sheets

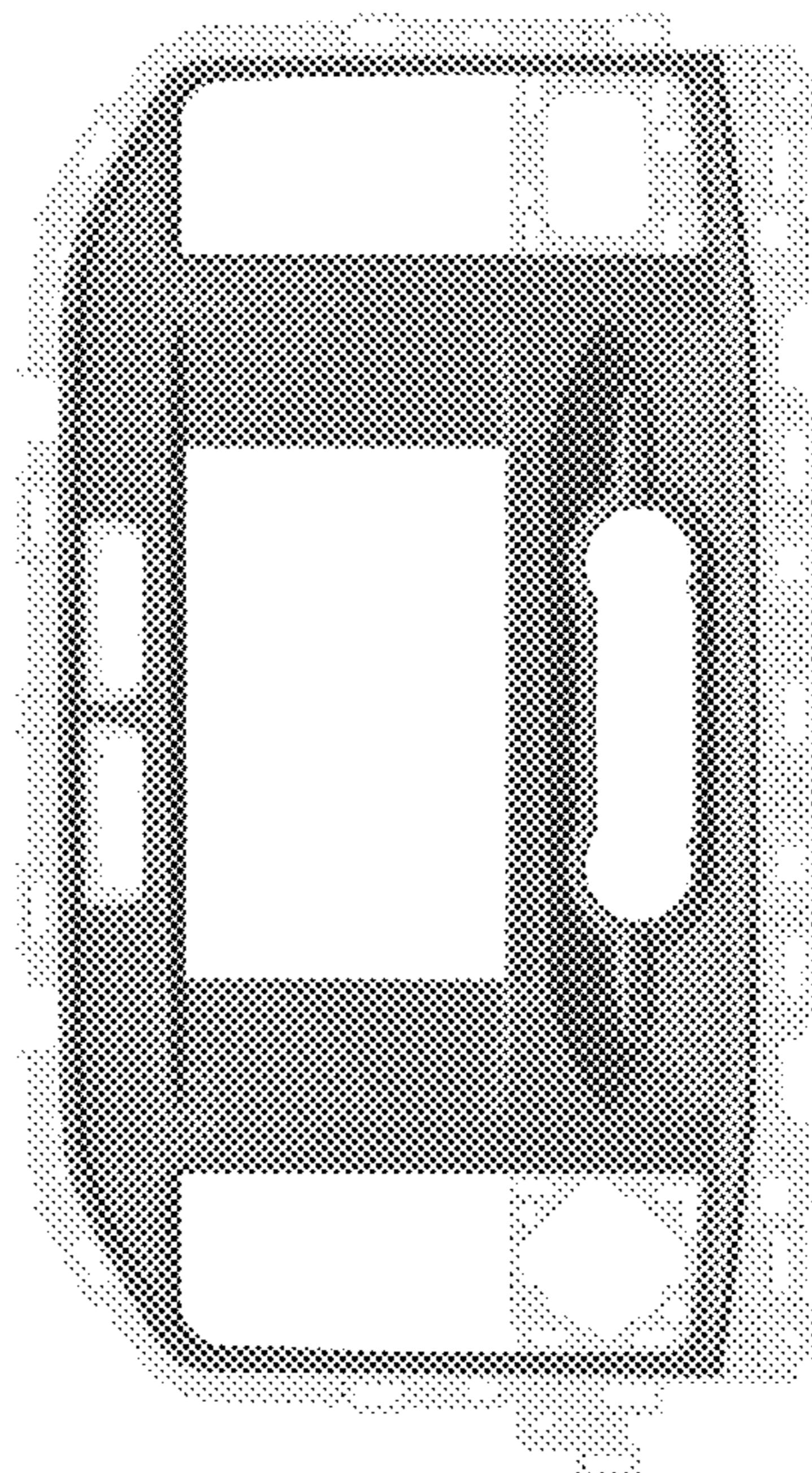

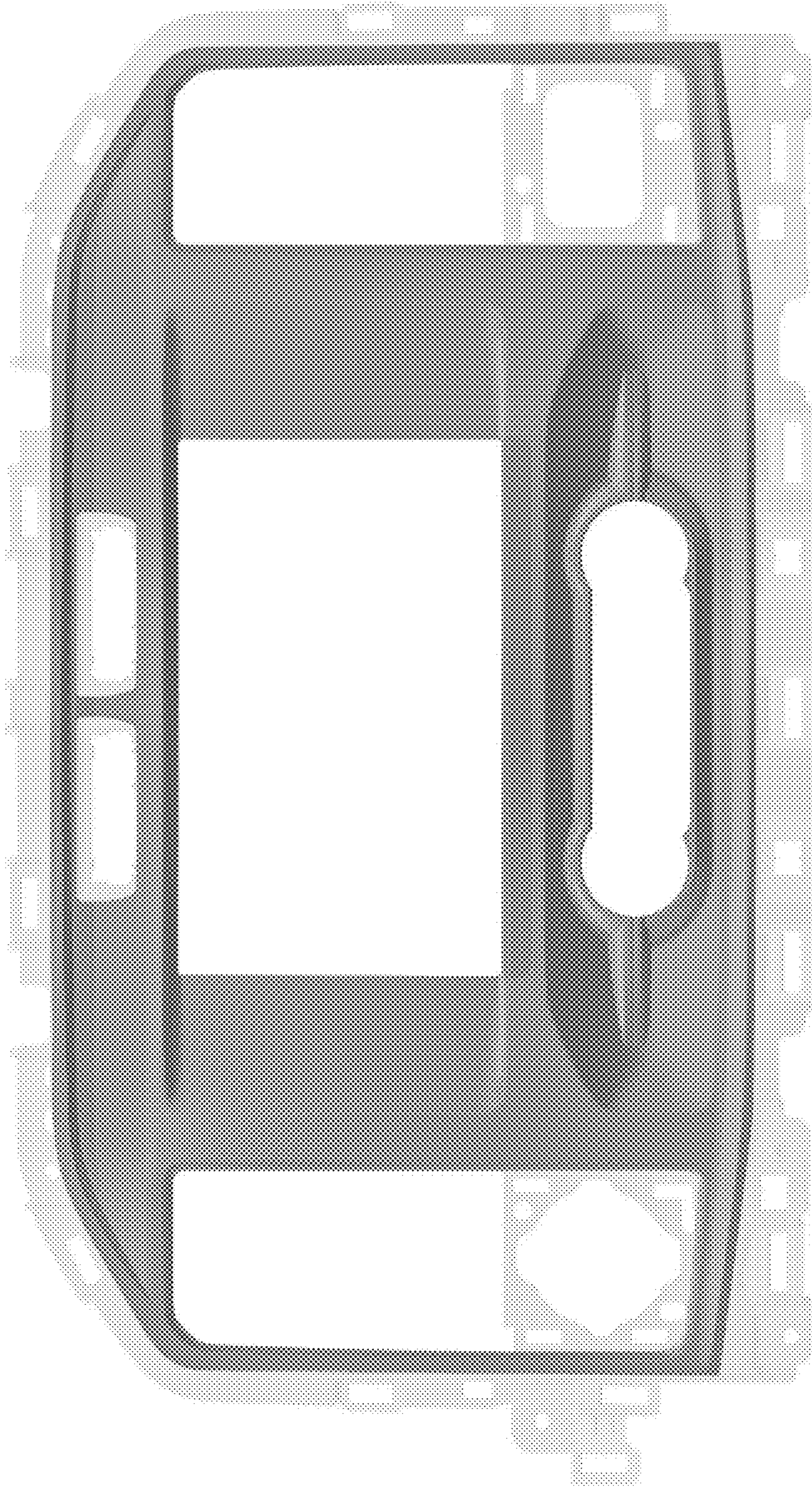

Fig.1

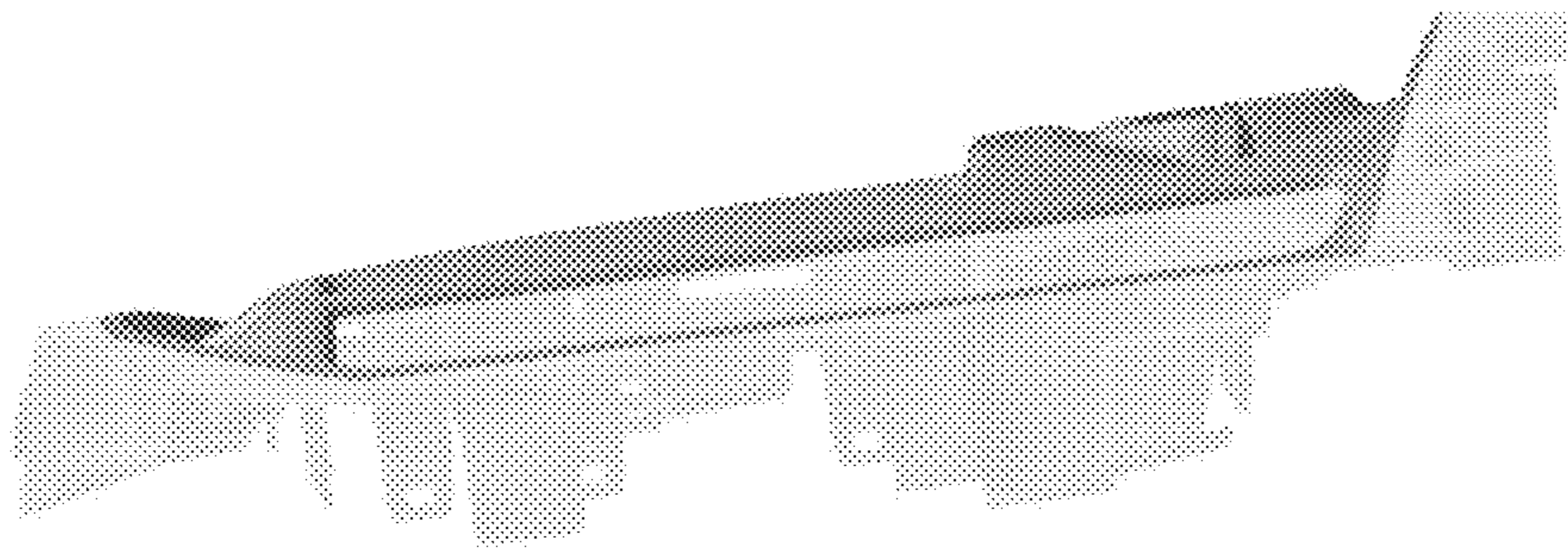

Fig.2

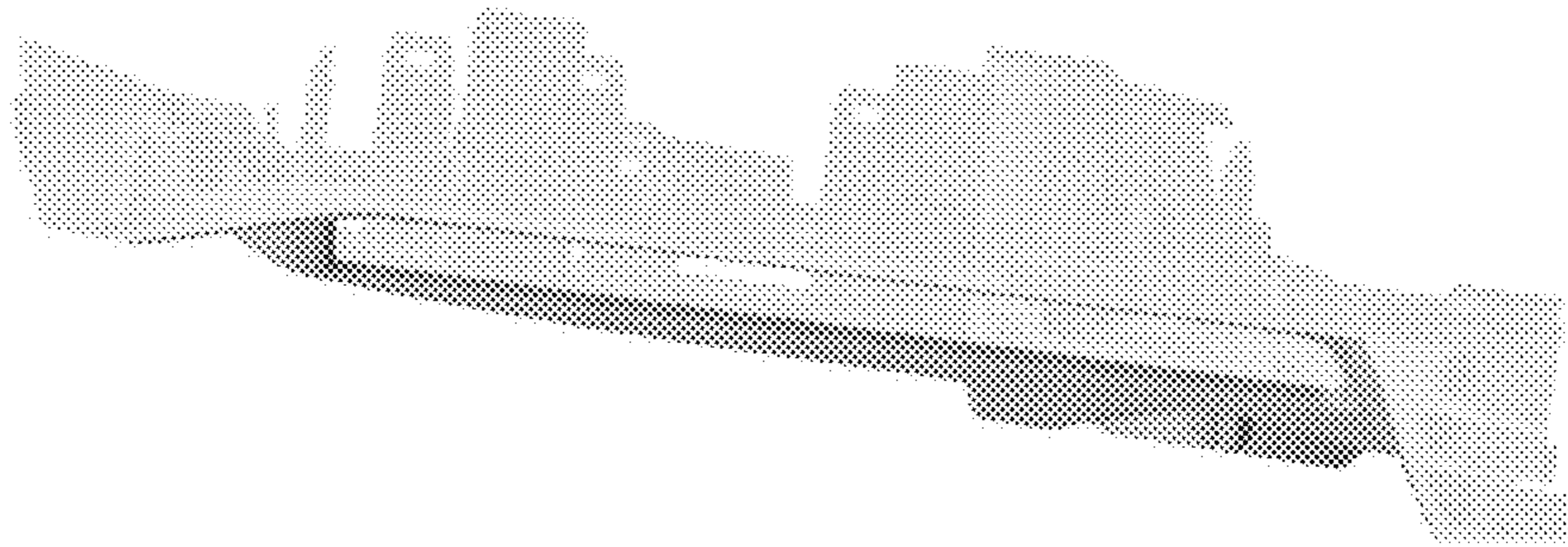

Fig. 3

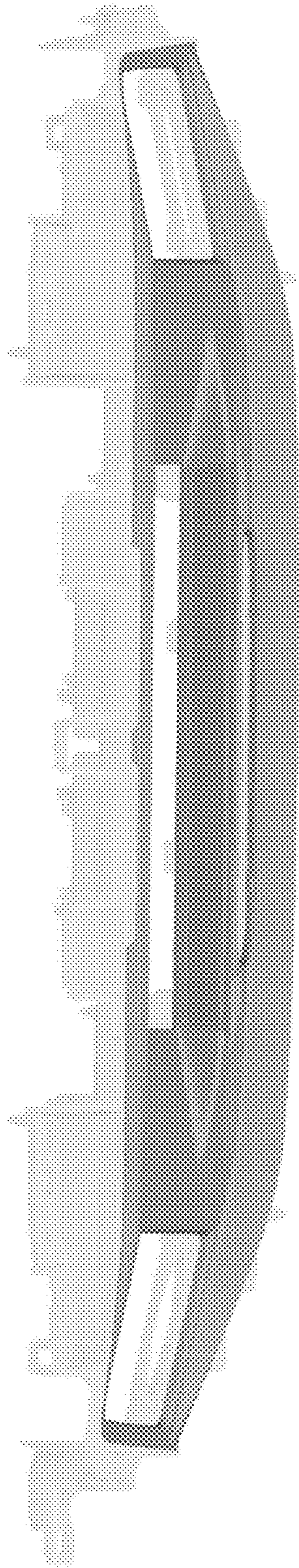

Fig. 4

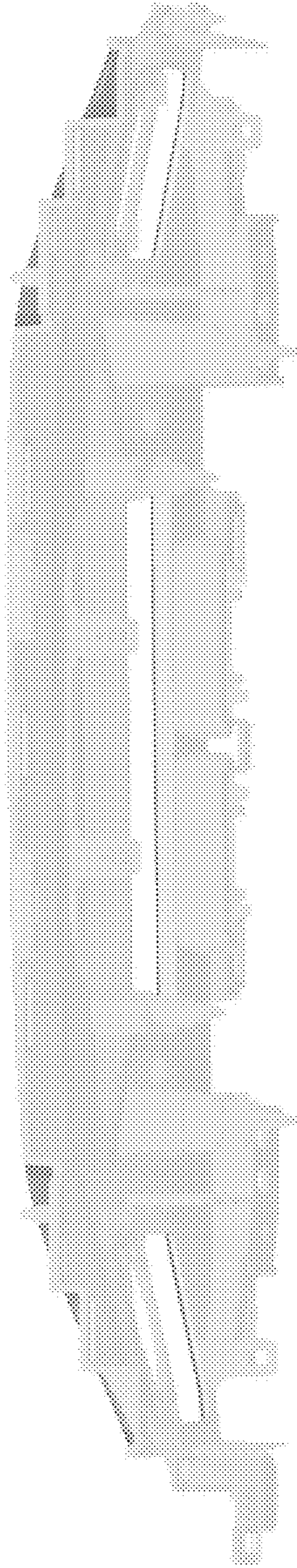

Fig. 5

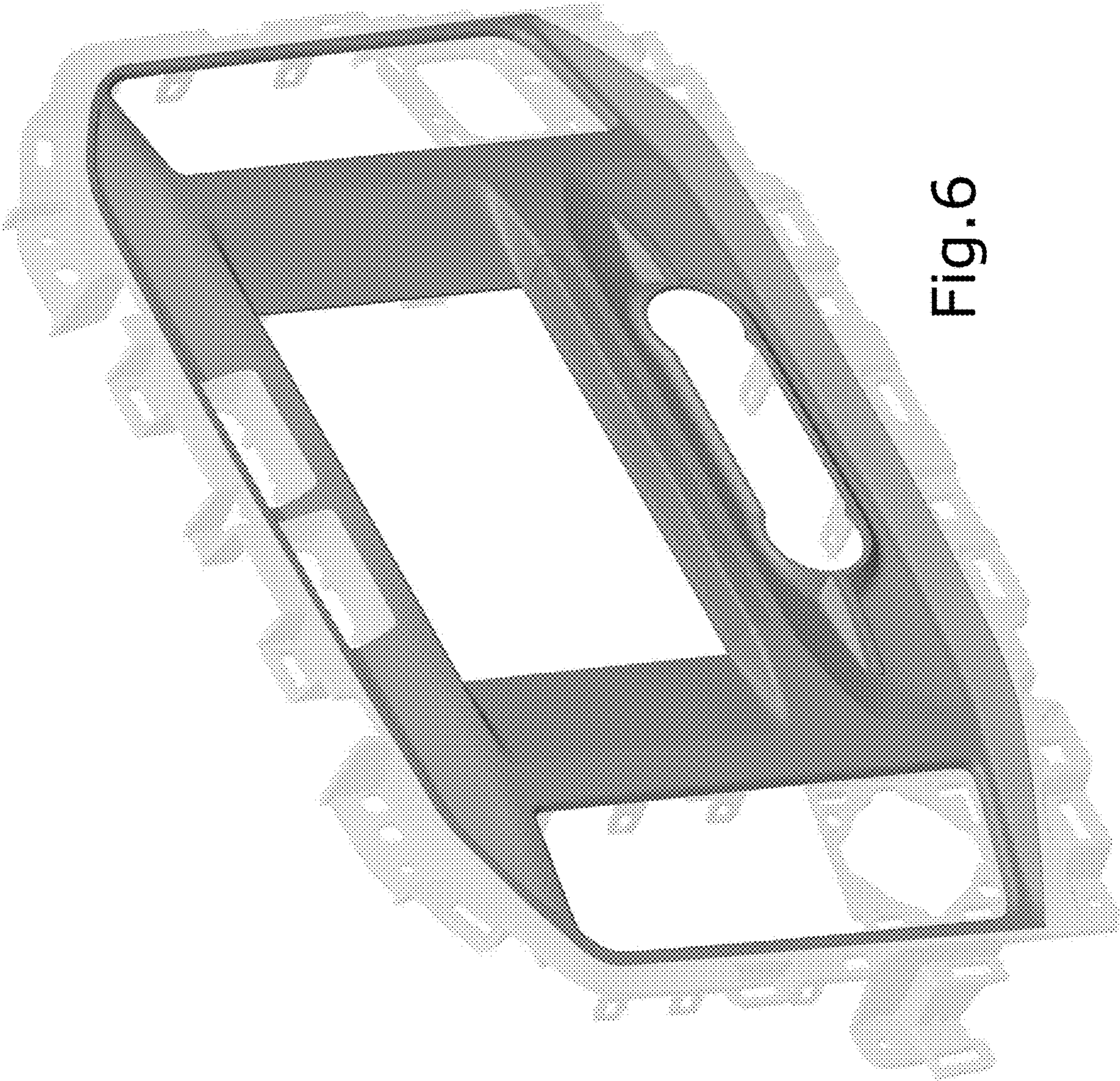

Fig. 6



Fig. 7