



US00D929275S

(12) **United States Design Patent**
Hamilton et al.

(10) **Patent No.:** **US D929,275 S**

(45) **Date of Patent:** **** Aug. 31, 2021**

(54) **VEHICLE FRONT UPPER GRILLE**

(71) Applicant: **Ford Global Technologies, LLC**,
Dearborn, MI (US)

(72) Inventors: **Christopher Hamilton**, Chelmsford
(GB); **Jordan Bennett**, Brentwood
(GB); **Simon Collins**, Sevenoaks (GB);
Daniel Rodriguez-Ramiro, London
(GB); **Elvir Mesalic**, Plymouth, MI
(US)

(73) Assignee: **Ford Global Technologies, LLC**,
Dearborn, MI (US)

(**) Term: **15 Years**

(21) Appl. No.: **29/731,723**

(22) Filed: **Apr. 17, 2020**

(51) **LOC (13) Cl.** **12-16**

(52) **U.S. Cl.**
USPC **D12/163**

(58) **Field of Classification Search**
USPC D12/163, 169, 196, 86, 90-92; 180/68.1,
180/68.6; 293/193.11
CPC B62D 25/08; B62B 9/16; B60K 11/08;
B60R 19/52
See application file for complete search history.

(56) **References Cited**

U.S. PATENT DOCUMENTS

D492,226 S * 6/2004 Kato D12/163
D678,134 S * 3/2013 Behmer D12/163

D698,288 S * 1/2014 Riggs D12/163
D712,797 S * 9/2014 Mays D12/163
D722,923 S * 2/2015 George D12/163
D753,029 S * 4/2016 Talsma D12/163
D754,037 S * 4/2016 Behmer D12/163
D754,039 S * 4/2016 Behmer D12/163
D764,980 S * 8/2016 Platto D12/98
D769,160 S * 10/2016 Platto D12/163
D803,732 S * 11/2017 Yang D12/163
D886,690 S * 6/2020 Hamilton D12/163
D887,320 S * 6/2020 Hamilton D12/163

* cited by examiner

Primary Examiner — Melody N Brown

(74) *Attorney, Agent, or Firm* — Michael Spenner

(57) **CLAIM**

The ornamental design for a vehicle front upper grille, as shown and described.

DESCRIPTION

FIG. 1 is a front elevational view of a vehicle front upper grille, showing our new design;
FIG. 2 is a left side elevational view thereof;
FIG. 3 is a right side elevational view thereof;
FIG. 4 is a top plan view thereof;
FIG. 5 is a bottom plan view thereof;
FIG. 6 is a top, front and left side perspective view thereof;
and,
FIG. 7 is a bottom, front and left side perspective view thereof.
The claimed design is indicated by the relatively dark portions in the figures. The de-emphasized and relatively light portions form no part of the claimed design.

1 Claim, 7 Drawing Sheets

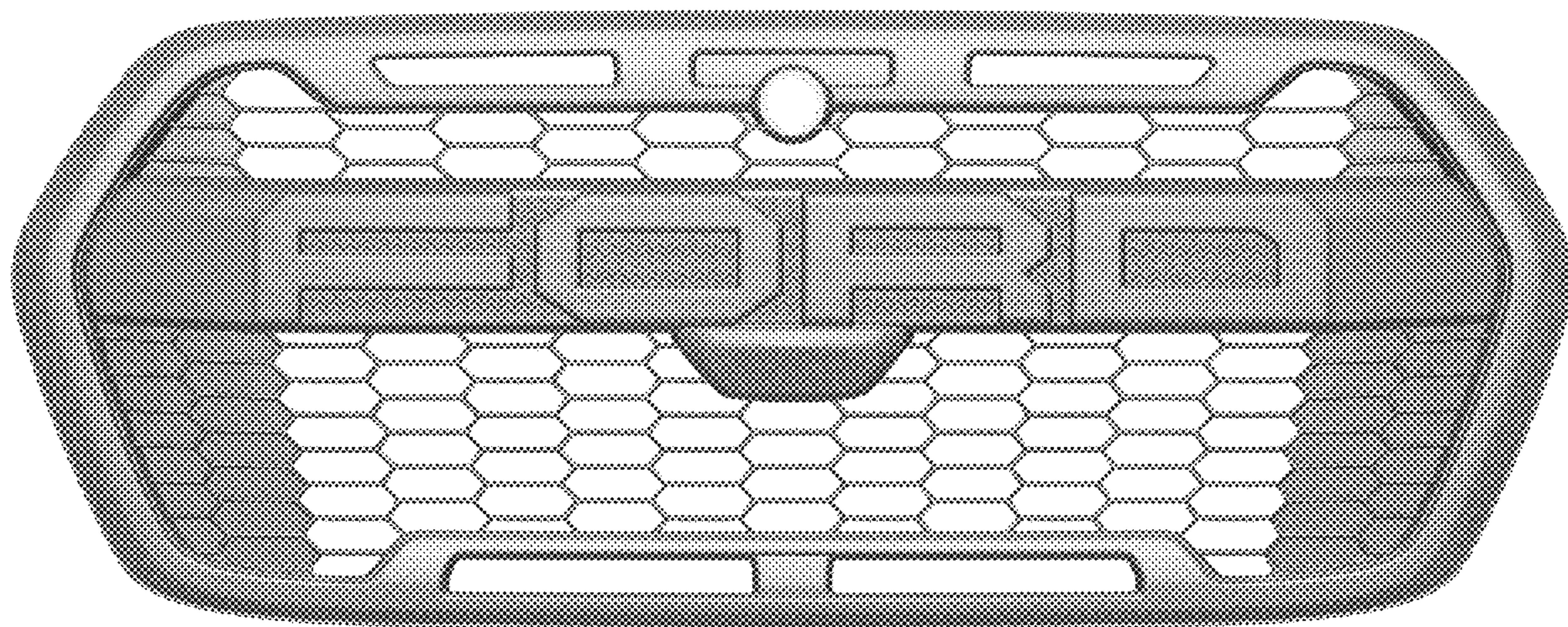

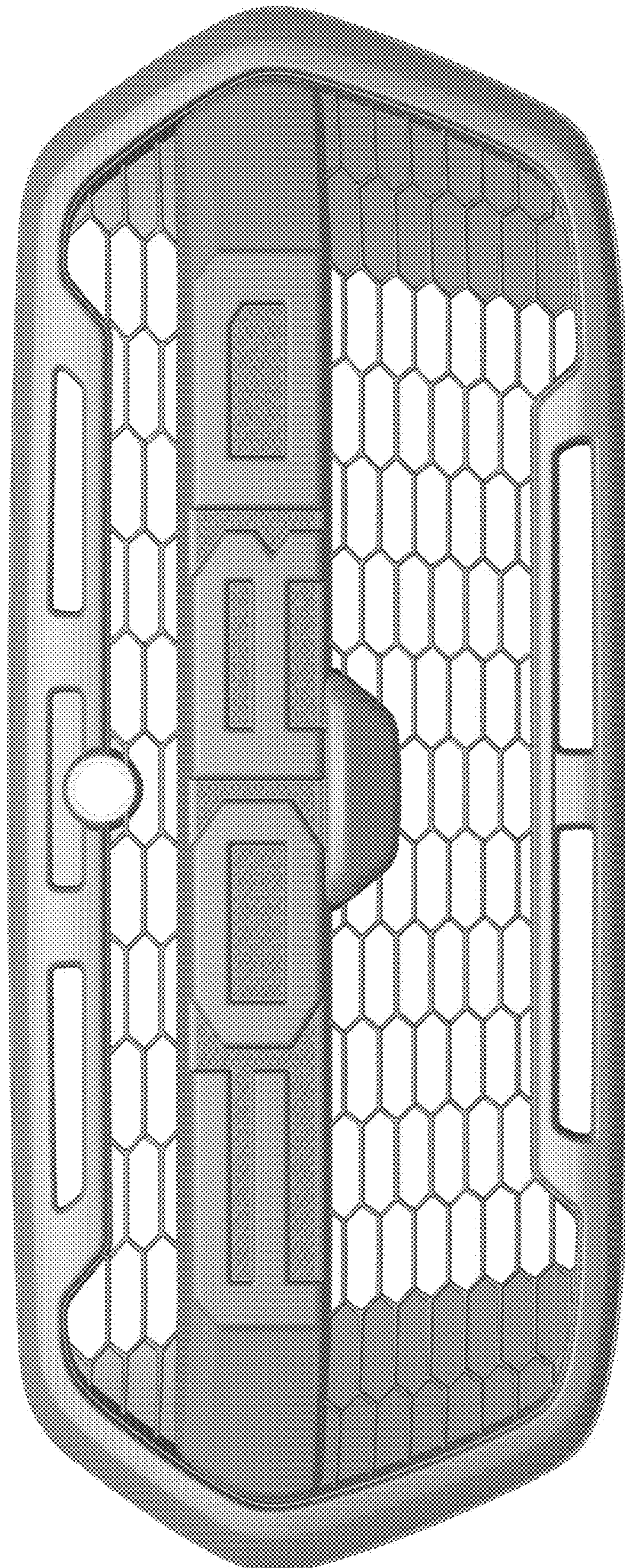

Fig.1

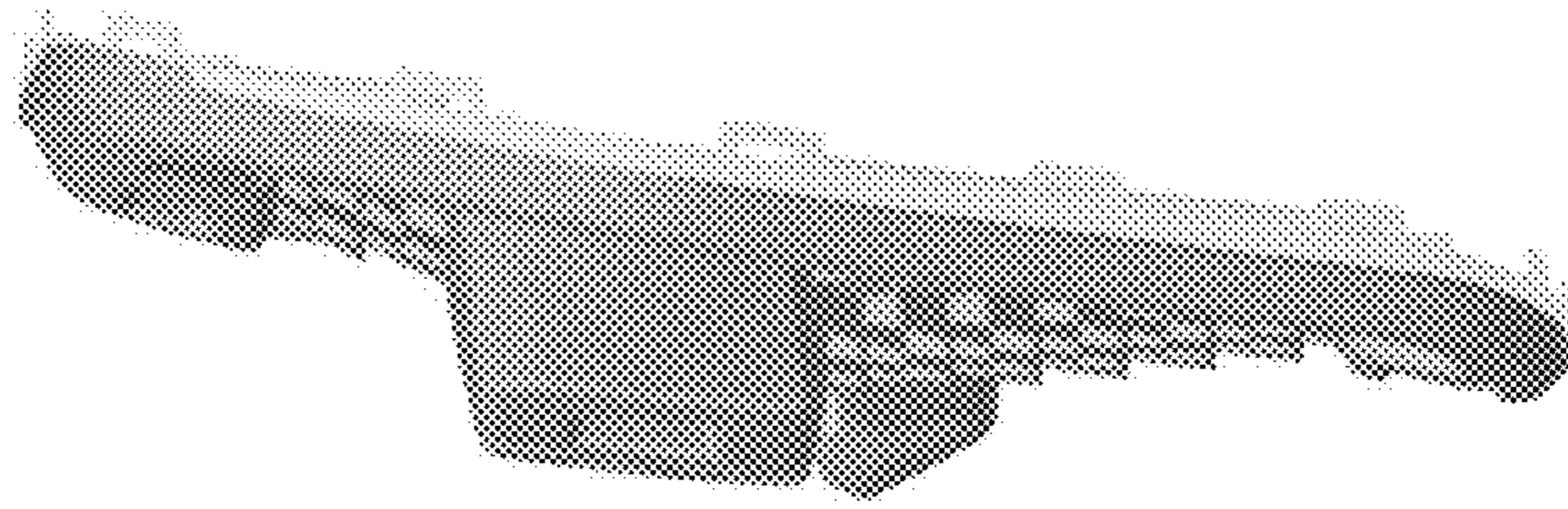

Fig. 2

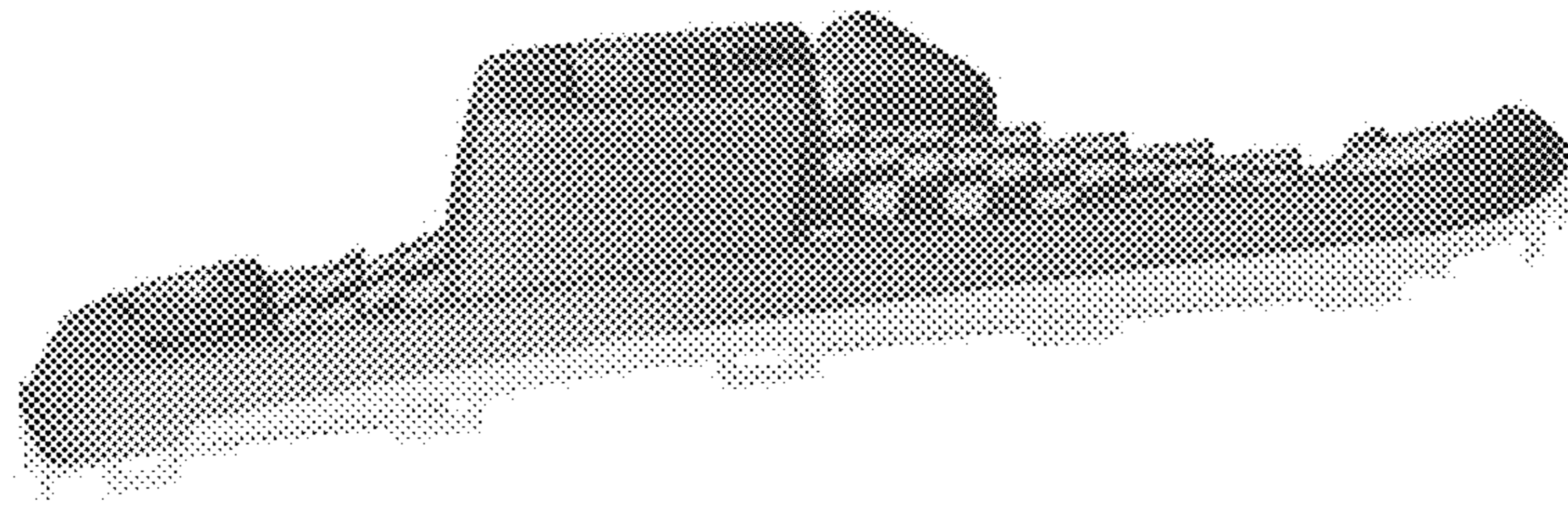

Fig. 3

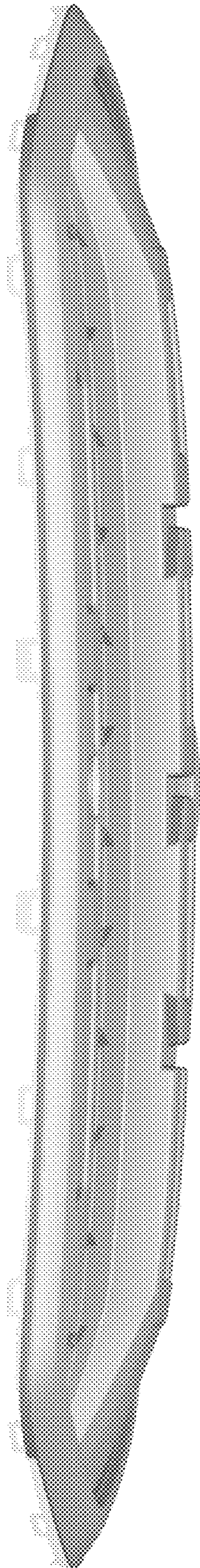

Fig.4

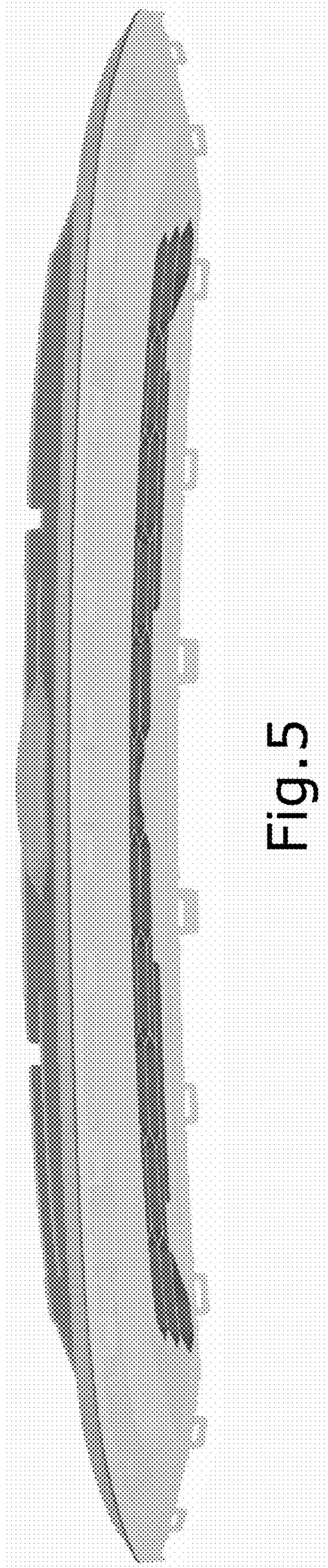

Fig. 5



Fig. 6

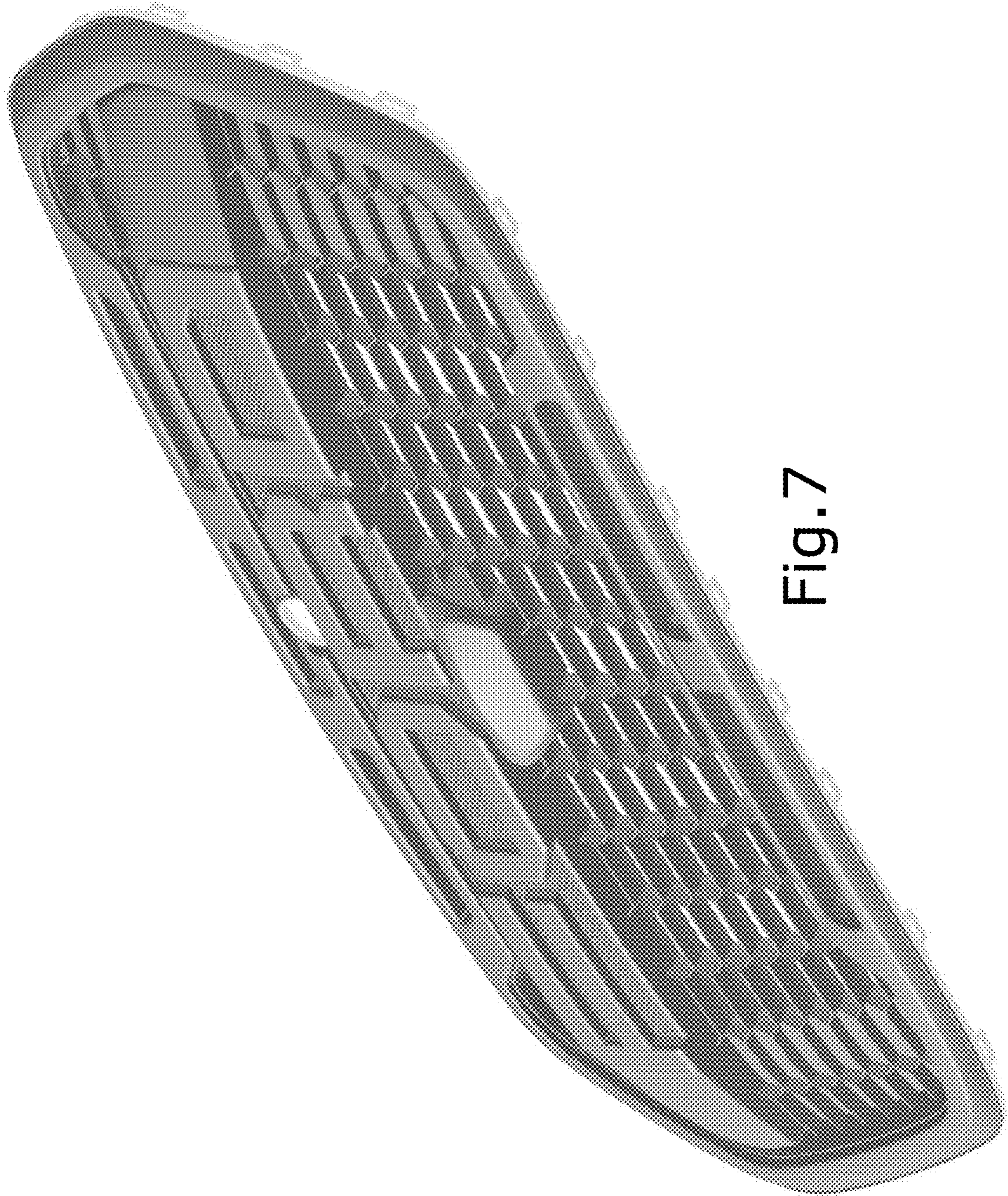

Fig. 7