



US00D929247S

(12) **United States Design Patent** (10) **Patent No.:** **US D929,247 S**
Yu (45) **Date of Patent:** **** Aug. 31, 2021**

(54) **WIRELESS BARBECUE THERMOMETER TRANSMITTER**

D847,006 S * 4/2019 Hu D10/57
D899,277 S * 10/2020 Wang D10/57

(71) Applicant: **FUZHOU ESUN ELECTRONIC CO., LTD**, Fuzhou (CN)

* cited by examiner

(72) Inventor: **Guo Yu**, Fuzhou (CN)

Primary Examiner — Leanne Was-Englehart

(73) Assignee: **FUZHOU ESUN ELECTRONIC CO., LTD**, Fuzhou (CN)

(74) *Attorney, Agent, or Firm* — Westbridge IP LLC

(**) Term: **15 Years**

(21) Appl. No.: **29/719,320**

(22) Filed: **Jan. 2, 2020**

(57) **CLAIM**

The ornamental design for a wireless barbecue thermometer transmitter, as shown and described.

(30) **Foreign Application Priority Data**

DESCRIPTION

Dec. 23, 2019 (CN) 201930722158.3

(51) **LOC (13) Cl.** **10-04**

(52) **U.S. Cl.**
USPC **D10/57**

(58) **Field of Classification Search**
USPC D10/49, 50, 52, 57, 78
CPC G01K 2207/02; G01K 2207/04; G01K 2207/06; G01K 2207/08; G01K 1/024
See application file for complete search history.

FIG. 1 is a front elevational view of a wireless barbecue thermometer transmitter showing my new design;
FIG. 2 is a right side view thereof;
FIG. 3 is a rear elevational view thereof;
FIG. 4 is a left side view thereof;
FIG. 5 is a top plan view thereof;
FIG. 6 is a bottom plan thereof;
FIG. 7 is a front perspective view thereof; and,
FIG. 8 is a rear perspective view thereof.

(56) **References Cited**

U.S. PATENT DOCUMENTS

D504,335 S * 4/2005 Stevenson D10/57
D837,669 S * 1/2019 Yu D10/57

The broken lines depict portions of the wireless barbecue thermometer transmitter that form no part of the claimed design.

1 Claim, 8 Drawing Sheets

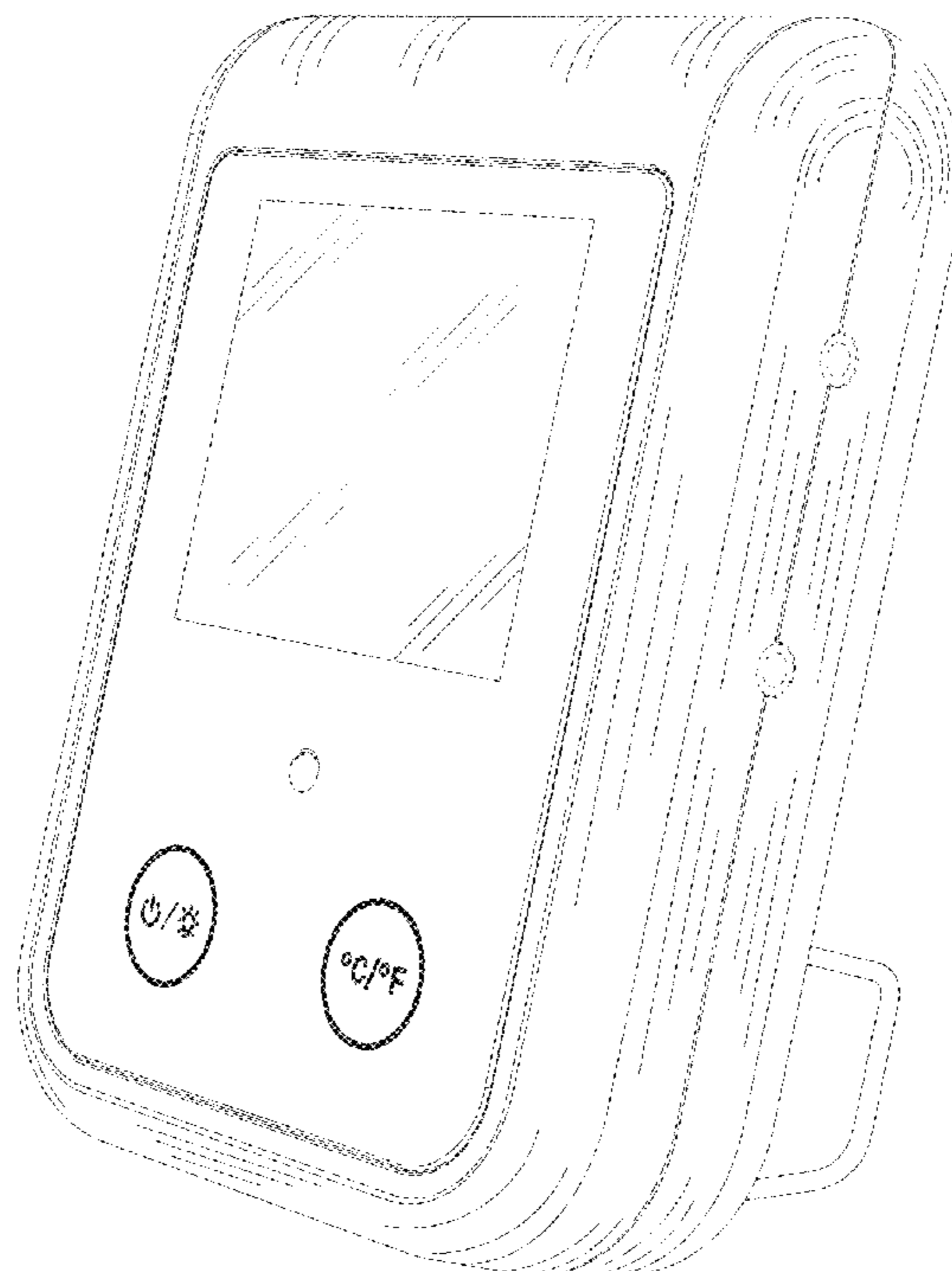

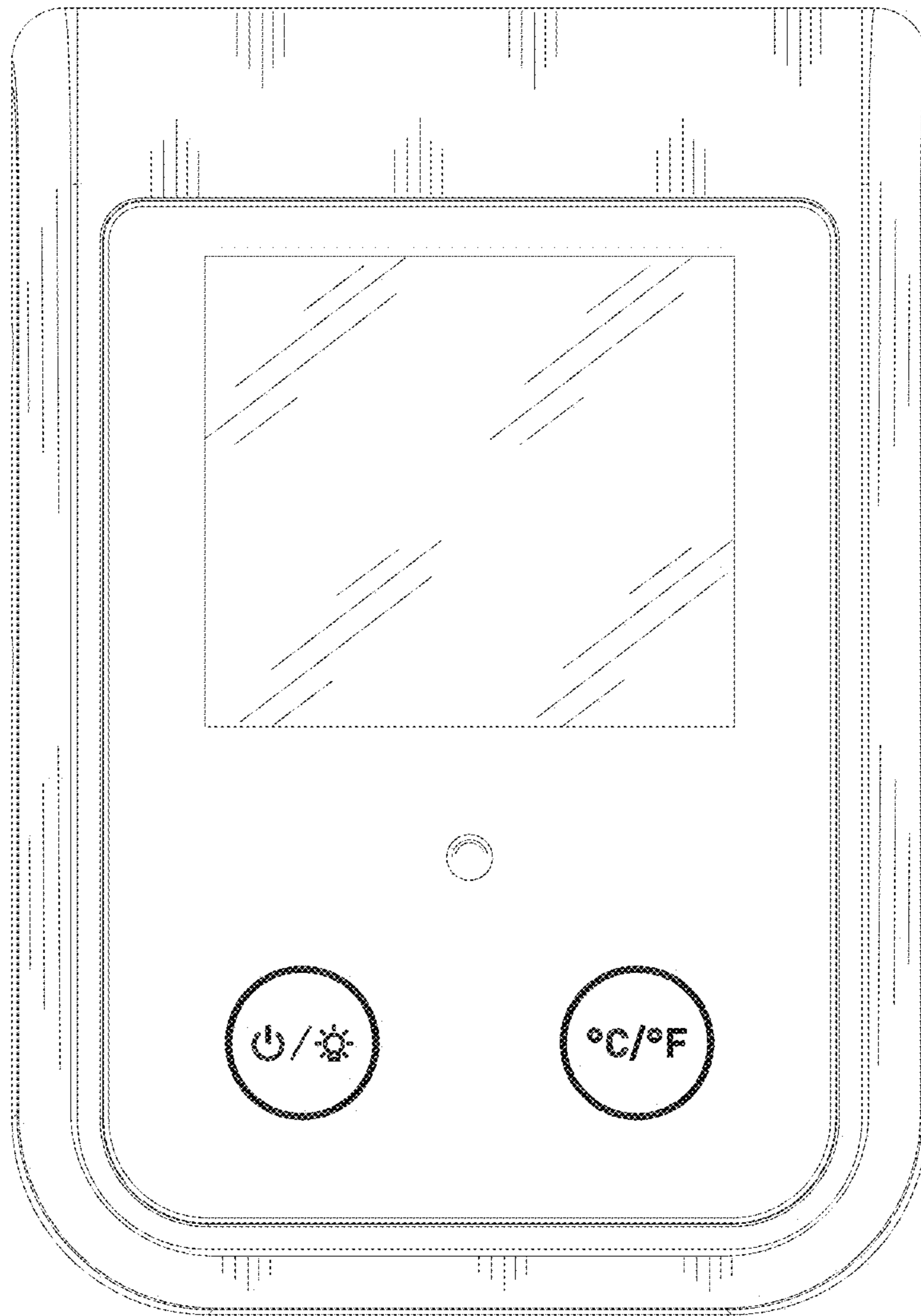

FIG. 1

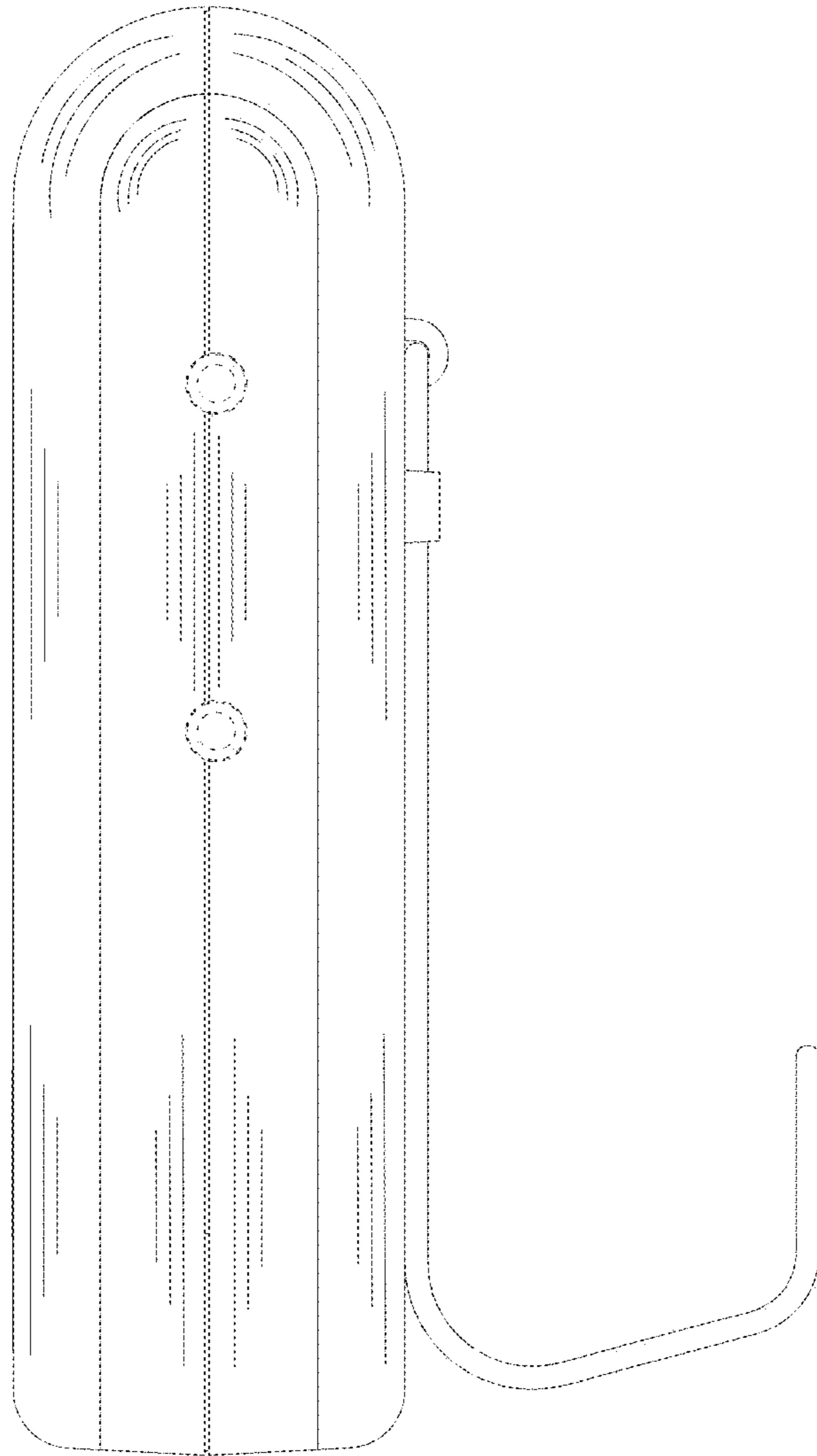

FIG.2

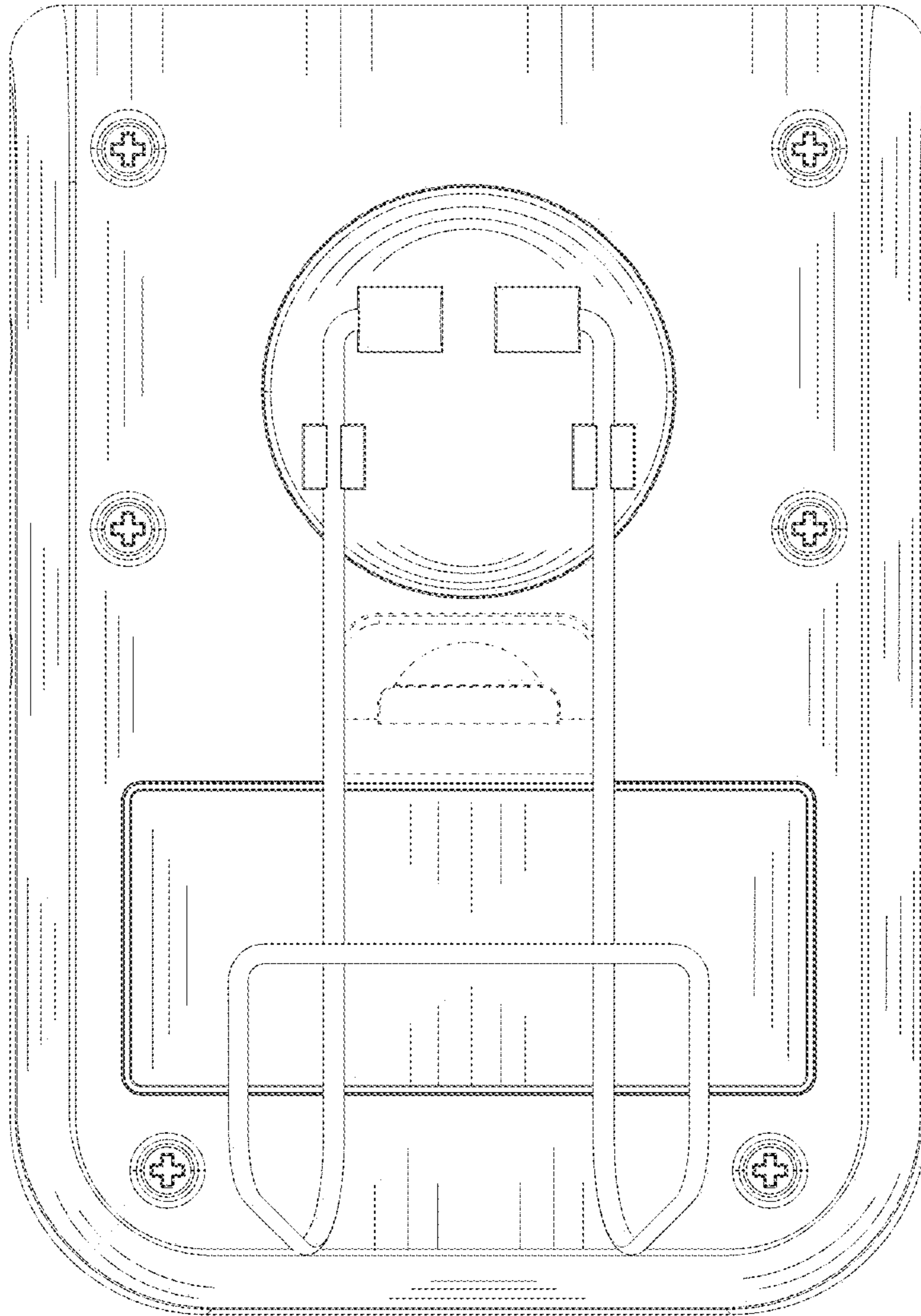

FIG. 3

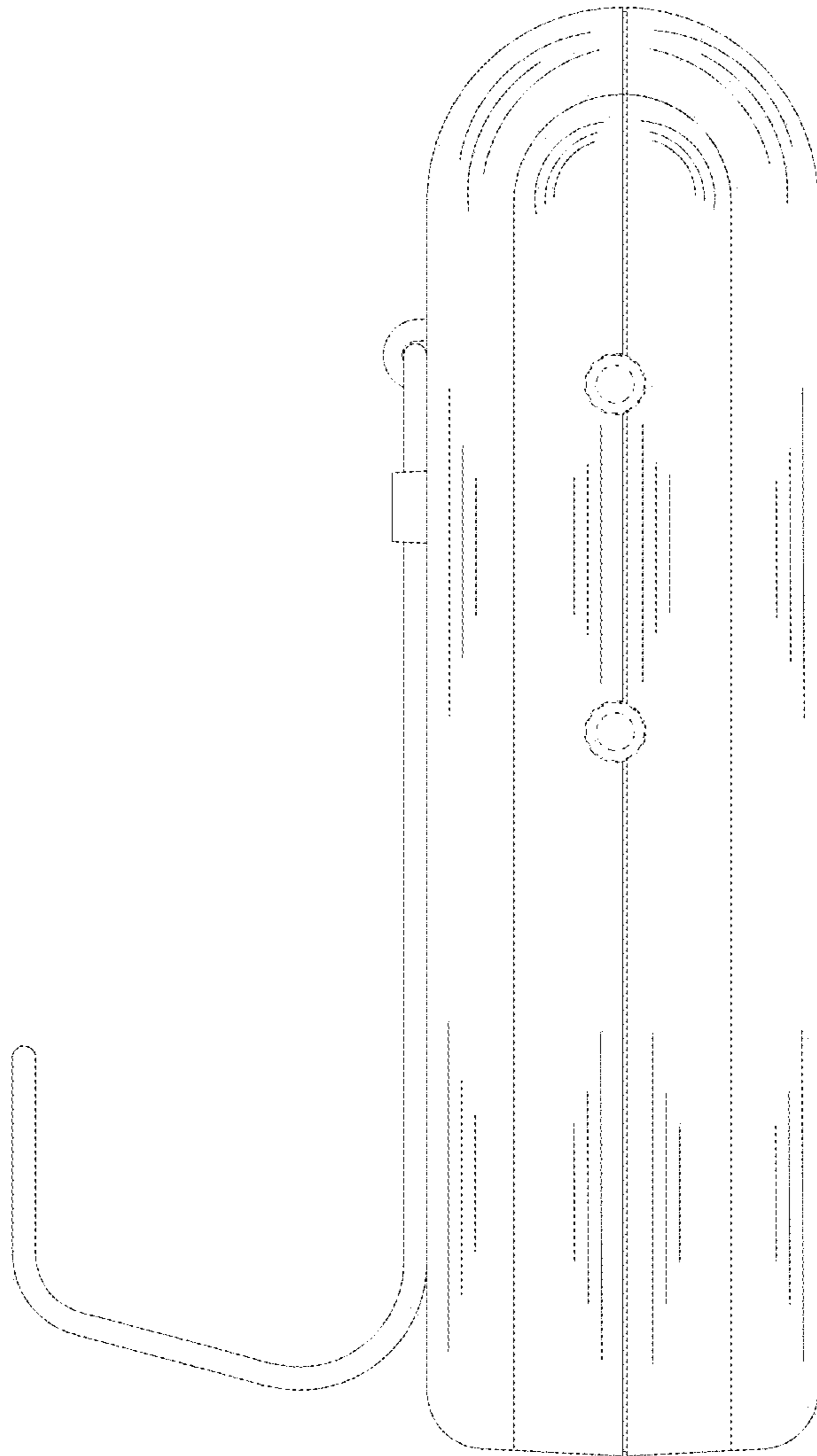

FIG.4

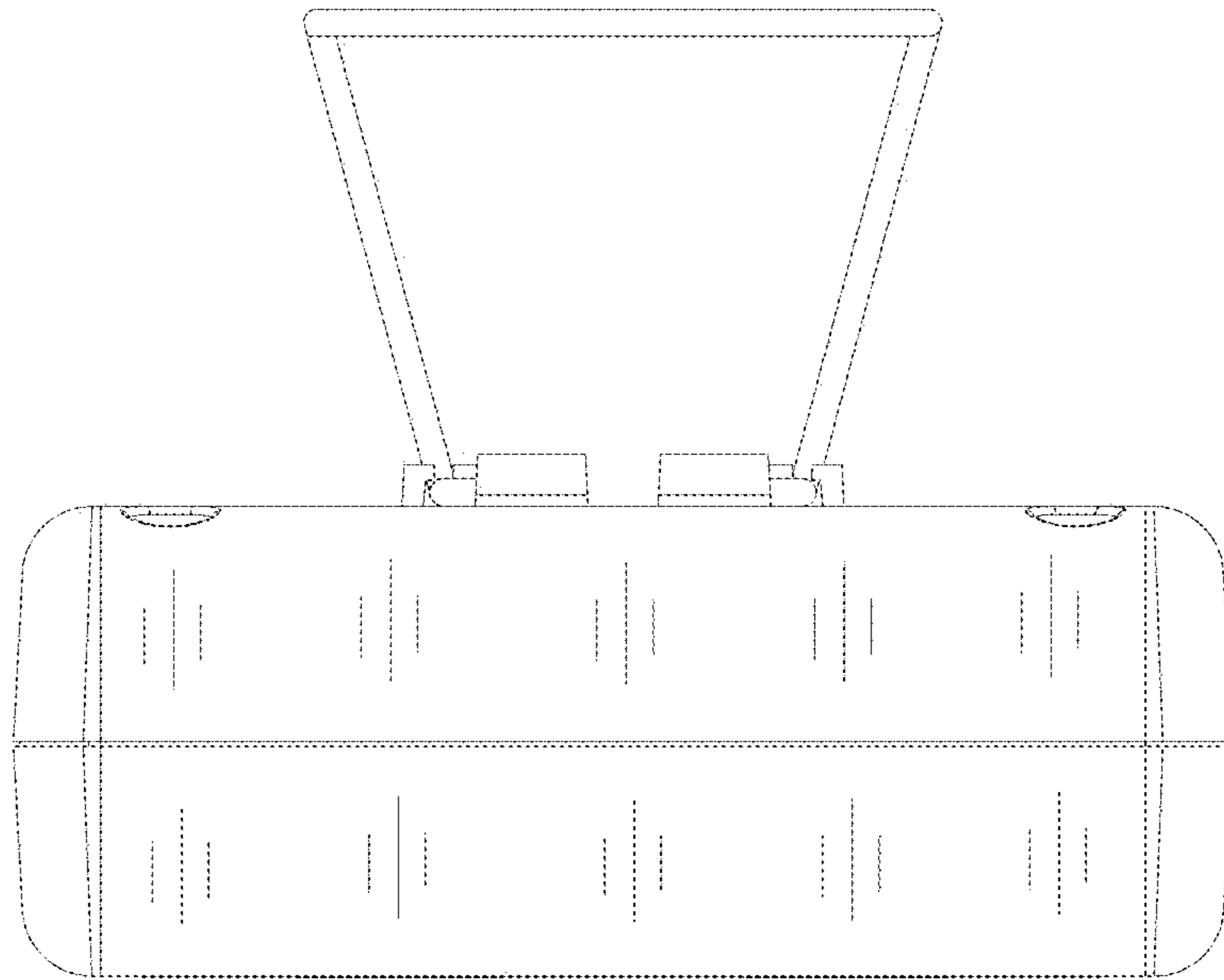

FIG.5

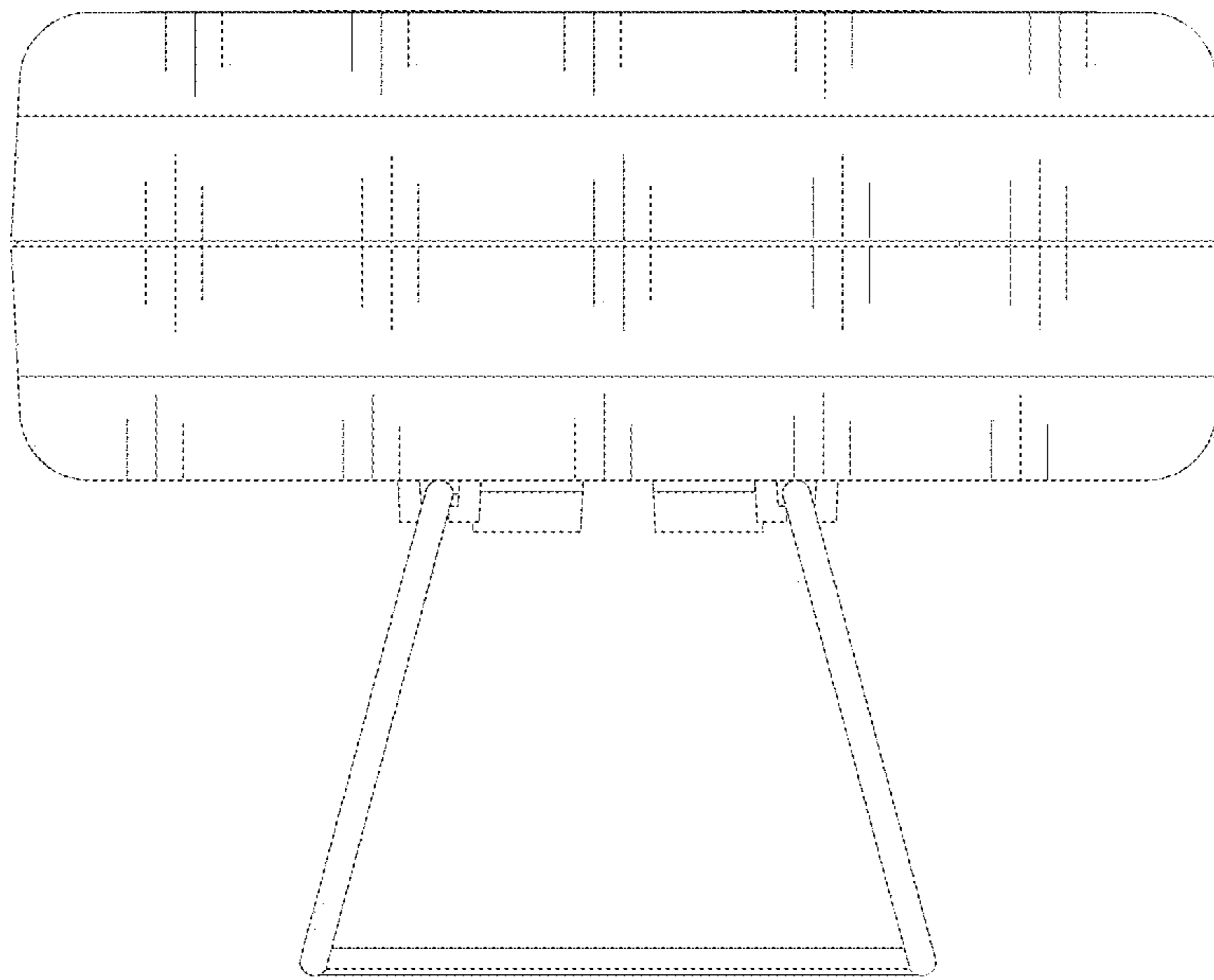

FIG. 6

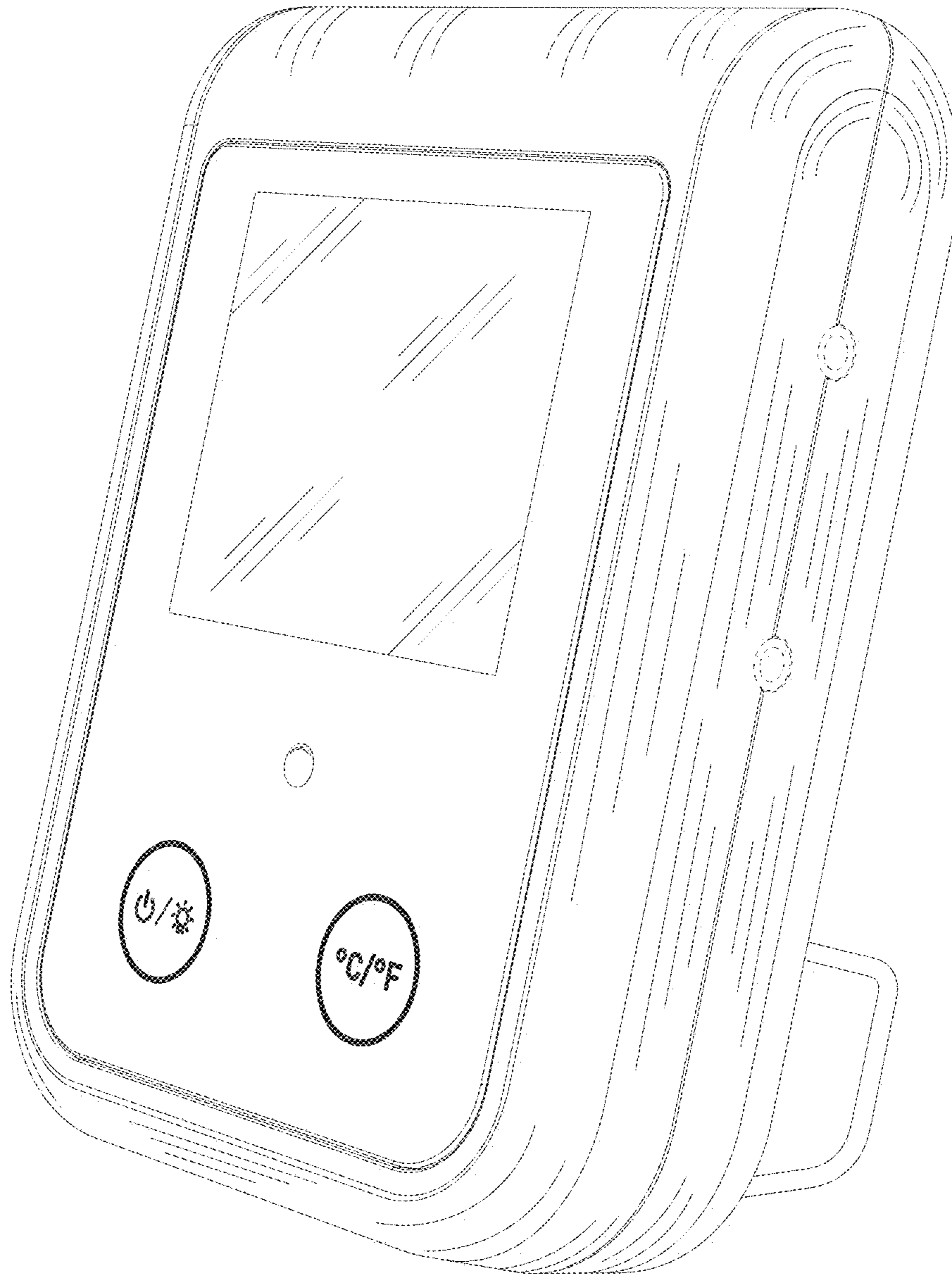

FIG. 7

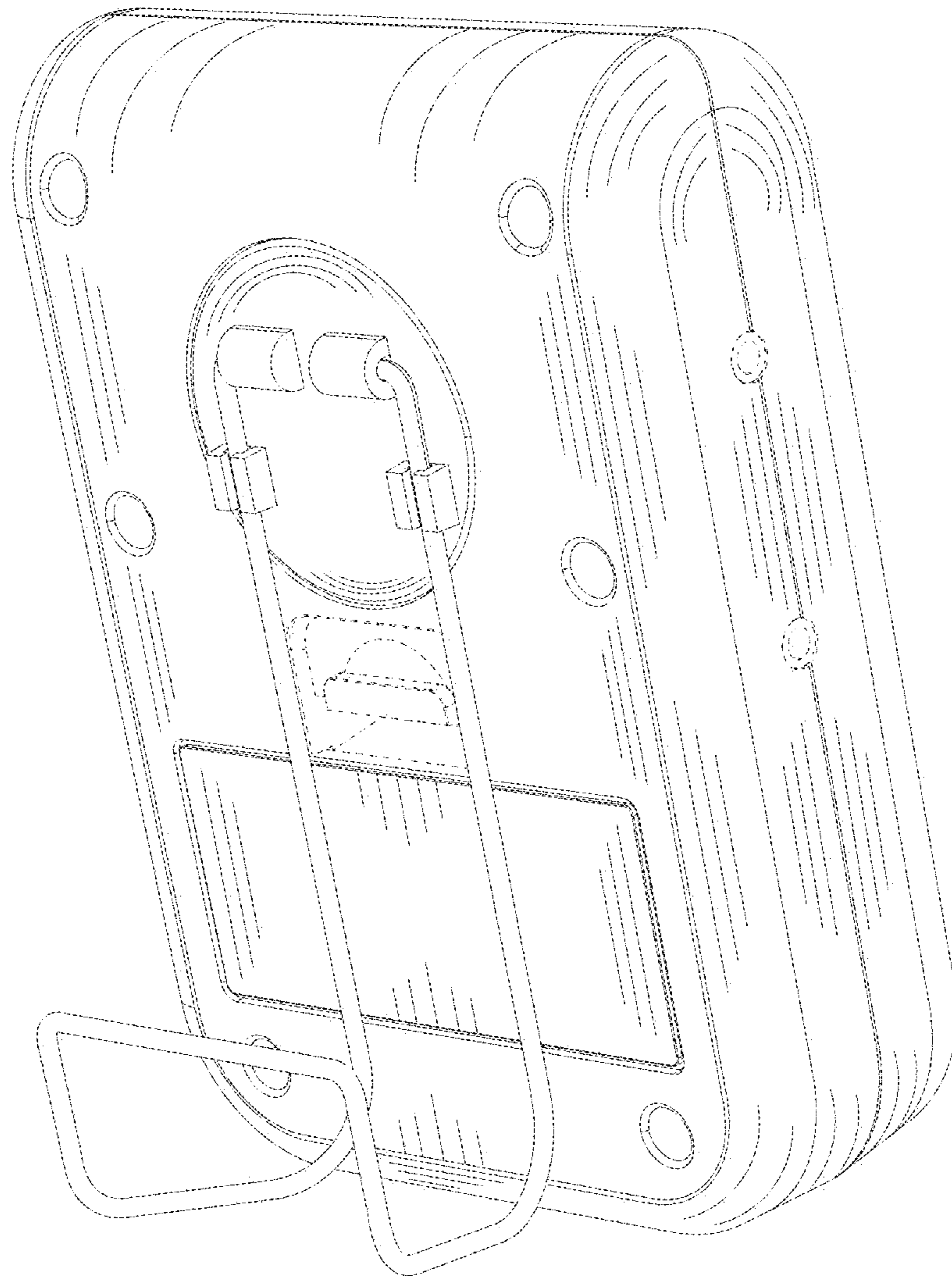

FIG. 8